

ENGINEERING
TOMORROW



Application Guide

iC7 Series Industry

OPEN UP A NEW DIMENSION OF INTELLIGENCE

PROGRAMMABLE
PREDICTIVE MAINTENANCE
DATA SECURITY
CONNECTIVITY
APPLICATION PERFORMANCE
POWER DENSITY



www.danfoss.com |

iC7

Contents

1 Introduction to the Application Guide

1.1 Version History	13
1.2 Purpose of this Application Guide	13
1.3 Additional Resources	13
1.4 Safety Symbols	13

2 Industry Application Software Overview

2.1 Industry Application Overview	15
2.2 Basic Functions	15
2.2.1 I/O Control and Statuses	15
2.2.2 Reference Handling	15
2.2.3 Ramps	15
2.2.4 Quick Stop	15
2.2.5 Limit Rotation Direction	15
2.2.6 Inching with Jogging Modes	15
2.2.7 Speed Bypass	16
2.2.8 Flying Start	16
2.2.9 Mains Dropout	16
2.2.10 Kinetic Backup	16
2.2.11 Resonance Damping	16
2.2.12 Motor Preheating	16
2.2.13 Mechanical Brake Control	16
2.2.14 Load Drooping	16
2.3 Controllers	16
2.3.1 Speed Controller	16
2.3.2 Torque Controller	17
2.3.3 Process Control	17
2.4 Motor Control Features	17
2.4.1 Motor Types	17
2.4.2 Torque Characteristics	17
2.4.3 Motor Control Principles	17
2.4.4 Motor Nameplate Data	17
2.4.5 Automatic Motor Adaptation (AMA)	17
2.4.6 Automation Energy Optimization (AEO)	17

2.5 Braking of Load	18
2.5.1 Overview of Braking of Load	18
2.5.2 Resistor Braking	18
2.5.3 Overvoltage Control (OVC)	18
2.5.4 DC Brake	18
2.5.5 AC Brake	18
2.5.6 DC Hold	18
2.5.7 Load Sharing	18
2.6 Protection Features	18
2.6.1 Grid Protection	18
2.6.2 Drive Protection	18
2.6.3 Motor Protection	19
2.6.4 Protection of External Filters or Brake Resistors	19
2.6.5 Automatic Derating	19
2.7 Monitoring, Logging, and History Log	19
2.7.1 Monitoring Features	19
2.7.2 Event Log	20
2.7.3 Logging and Storage of Data	20
2.7.4 Preventive Maintenance	20
2.8 Functional Safety	20
2.9 Software Tools	20
2.9.1 Overview of Software Tools	20
2.9.2 MyDrive® Select	20
2.9.3 MyDrive® Harmonics	20
2.9.4 MyDrive® ecoSmart™	21
2.9.5 MyDrive® Insight	21
2.10 Security Features	21
2.11 Motor Control Features for FVC+ and VVC+ Control	21
2.11.1 Compatibility of Motor Control Features for FVC+ and VVC+ Control	21
2.11.2 High Frequency Voltage Injection	23
2.12 PROFIdrive - Standard Telegram 1	24
2.12.1 Overview	24
2.12.2 Control Word	24
2.12.3 Status Word (STW) in PROFIdrive Standard Telegram 1	25
2.12.4 PROFIdrive State Machine	27
2.13 iC Speed Profile	27

2.13.1 Overview	27
2.13.2 Control Word	28
2.13.3 Status Word (STW) in iC Speed Profile	29

3 User Interfaces

3.1 Overview of User Interfaces	31
3.2 Control Panel	31
3.2.1 iC7 Control Panel Options	31
3.2.2 Control Panel Elements	32
3.2.3 Control Panel Basic Configurations	33
3.2.4 Starting the Drive and Control Panel Display	34
3.2.5 Understanding Status Screens	34
3.2.6 Adjusting Display Backlight and Contrast	36
3.2.7 Changing the Content of the Status Screens	36
3.2.8 Main Menu and Overall Navigation	36
3.2.9 Changing the Selections of a Parameter	37
3.2.10 Changing a Parameter Value	38
3.2.11 Locking the Control Panel Display	39
3.2.12 Control Panel Shortcuts	39
3.2.13 Backup and Restore	39
3.2.13.1 Making a System Backup Using the Control Panel	39
3.2.13.2 Restoring the System Configuration Using the Control Panel	41
3.3 MyDrive® Insight	42
3.3.1 Introduction to MyDrive® Insight	42
3.3.2 Getting Started with MyDrive® Insight	43
3.3.3 Accessing Parameters and Understanding Parameter Screens in MyDrive® Insight	44
3.3.4 Viewing and Changing Parameter Settings	46
3.3.5 PC Control: Operating the Drive Using MyDrive® Insight	48
3.3.6 Datalogger	49
3.3.6.1 Introduction to Datalogger	49
3.3.6.2 Configuring Datalogger	49
3.3.7 Backup and Restore	54
3.3.7.1 MyDrive® Insight Backup	54
3.3.7.2 Backing up the Drive	54
3.3.7.3 Restoring the Data to the Drive	56

4 Application Software Structure and Overview

4.1 Understanding Application Software Structure Principles	60
4.2 Parameter Groups and their Content	60

5 Configuration Set-up Examples

5.1 Configuration Prerequisites	63
5.2 Basic Setup of a Drive	64
5.3 Configuring the Motor, Motor Control, and Motor Thermal Protection	64
5.4 Configuring Speed Control	67
5.5 Configuring Torque Control	69
5.6 Configuring Process Control	71
5.7 Configuring a Latched Start/Stop with Digital I/O	75

6 Parameter Descriptions

6.1 Introduction to Parameter Descriptions	77
6.1.1 Reading the Parameter Table	77
6.1.2 Understanding Data Types	77
6.1.3 Understanding Parameter Types	78
6.1.4 Understanding Access Types	78
6.2 Grid (Menu Index 1)	78
6.2.1 Grid Overview	78
6.2.2 Grid Status (Menu Index 1.1)	78
6.2.3 Grid Settings (Menu Index 1.2)	81
6.2.4 Grid Protection (Menu Index 1.3)	82
6.3 Power Conversion & DC Link (Menu Index 2)	83
6.3.1 Power Conversion & DC-Link Overview	83
6.3.2 Power Conversion & DC Link Status (Menu Index 2.1)	83
6.3.3 Power Unit Settings (Menu Index 2.2)	85
6.3.3.1 General Settings (Menu Index 2.2.1)	85
6.3.3.2 Cooling Fan Control (Menu Index 2.2.2)	91
6.3.4 Protection (Menu Index 2.3)	92
6.3.4.1 Settings (Menu Index 2.3.1)	92
6.3.4.2 Overvoltage Protection (Menu Index 2.3.2)	95
6.3.4.3 Power Loss (Menu Index 2.3.3)	96
6.3.5 Modulation (Menu Index 2.4)	99

6.4	Filters & Brake Chopper (Menu Index 3)	100
6.4.1	Filters & Brake Chopper Overview	100
6.4.2	Filters & Brake Chopper Status (Menu Index 3.1)	100
6.4.3	Brake Chopper (Menu Index 3.2)	100
6.4.4	Brake Resistor (Menu Index 3.3)	101
6.4.5	Advanced Harmonic Filter (Menu Index 3.4)	102
6.4.6	Output Filter (Menu Index 3.5)	103
6.5	Motor (Menu Index 4)	104
6.5.1	Motor Overview	104
6.5.2	Motor Status (Menu Index 4.1)	104
6.5.3	Motor Data (Menu Index 4.2)	108
6.5.3.1	General Settings (Menu Index 4.2.1)	108
6.5.3.2	Motor Nameplate Data (Menu Index 4.2.2)	111
6.5.3.3	Induction Motor (Menu Index 4.2.3)	112
6.5.3.4	Permanent Magnet Motor (Menu Index 4.2.4)	113
6.5.4	Motor Control (Menu Index 4.3)	115
6.5.4.1	General Settings (Menu Index 4.3.1)	115
6.5.4.2	Running a Motor Feedback Test	117
6.5.4.3	U/f Settings (Menu Index 4.3.2)	117
6.5.4.4	FVC+ Settings (Menu Index 4.3.3)	120
6.5.4.5	VVC+ & U/f Settings (Menu Index 4.3.4)	123
6.5.5	Protection (Menu Index 4.5)	125
6.6	Application (Menu Index 5)	128
6.6.1	Application Overview	128
6.6.2	Application Status (Menu Index 5.1)	128
6.6.3	Protection (Menu Index 5.2)	132
6.6.3.1	Cooling Monitor (Menu Index 5.2.1)	132
6.6.3.2	External Event (Menu Index 5.2.2)	132
6.6.3.3	Measured Temp. Protection (Menu Index 5.2.3)	134
6.6.3.4	Blocked Rotor Detection (Menu Index 5.2.6)	140
6.6.3.5	Lost Load Detection (Menu Index 5.2.7)	141
6.6.3.6	HMI Connection Loss (Menu Index 5.2.9)	141
6.6.3.7	Live Zero (Menu Index 5.2.15)	142
6.6.3.8	Feedback Handling (Menu Index 5.2.16)	142
6.6.4	Load (Menu Index 5.3)	143
6.6.4.1	Load Status (Menu Index 5.3.1)	143
6.6.4.2	Inertia (Menu Index 5.3.2)	143

6.6.4.3 Torque & AEO (Menu Index 5.3.3)	144
6.6.5 Operation Mode (Menu Index 5.4)	145
6.6.5.1 Settings (Menu Index 5.4.2)	145
6.6.6 Control Places (Menu Index 5.5)	146
6.6.6.1 Control Places Overview	146
6.6.6.2 Control Places Status (Menu Index 5.5.1)	147
6.6.6.3 Control Place Settings (Menu Index 5.5.2)	148
6.6.6.4 Local Control (Menu Index 5.5.3)	149
6.6.6.5 Fieldbus control (Menu Index 5.5.4)	152
6.6.6.6 I/O Control (Menu Index 5.5.5)	155
6.6.6.7 Advanced control (Menu Index 5.5.6)	159
6.6.7 Start Settings (Menu Index 5.6)	166
6.6.7.1 Start Settings Overview	166
6.6.7.2 General Settings (Menu Index 5.6.1)	167
6.6.7.3 DC Start (Menu Index 5.6.2)	168
6.6.7.4 Synchronous Motor Start (Menu Index 5.6.3)	169
6.6.8 Stop Settings (Menu Index 5.7)	170
6.6.8.1 Stop Settings Overview	170
6.6.8.2 Settings (Menu Index 5.7.1)	171
6.6.8.3 DC Injection (Menu Index 5.7.2)	172
6.6.8.4 Quick Stop (Menu Index 5.7.3)	173
6.6.8.5 AC Brake (Menu Index 5.7.4)	173
6.6.9 Speed Control (Menu Index 5.8)	174
6.6.9.1 Speed Control Overview	174
6.6.9.2 Speed Control Status (Menu Index 5.8.1)	176
6.6.9.3 Speed Controller (Menu Index 5.8.2)	178
6.6.9.4 Speed Limits and Monitor (Menu Index 5.8.3)	181
6.6.9.5 Speed Reference (Menu Index 5.8.4)	183
6.6.9.6 Reference Freeze (Menu Index 5.8.5)	186
6.6.9.7 Speed Ramps (Menu Index 5.8.6)	189
6.6.9.8 Speed Feedback (Menu Index 5.8.7)	197
6.6.9.9 Speed Bypass (Menu Index 5.8.8)	197
6.6.9.10 Load Drooping (Menu Index 5.8.9)	199
6.6.9.11 Auto Tuning (Menu Index 5.8.11)	201
6.6.10 Torque control (Menu Index 5.9)	202
6.6.10.1 Torque Control Overview	202
6.6.10.2 Torque Control Status (Menu Index 5.9.1)	204
6.6.10.3 Limits (Menu Index 5.9.2)	205

6.6.10.4 Torque Reference (Menu Index 5.9.3)	209
6.6.11 Process Control (Menu Index 5.10)	212
6.6.11.1 Process Control Overview	212
6.6.11.2 Process Control Status (Menu Index 5.10.1)	212
6.6.11.3 General Settings (Menu Index 5.10.2)	214
6.6.11.4 Process Reference (Menu Index 5.10.3)	215
6.6.11.5 Feedback (Menu Index 5.10.4)	219
6.6.11.6 PID Controller (Menu Index 5.10.5)	222
6.6.11.7 Feedforward Controller (Menu Index 5.10.6)	223
6.6.11.8 Auto Tuning (Menu Index 5.10.7)	225
6.6.12 Inching (Menu Index 5.11)	225
6.6.13 Mechanical Brake Control (Menu Index 5.12)	227
6.6.13.1 Mechanical Brake Control Overview	227
6.6.13.2 Mechanical Brake Control Status (Menu Index 5.12.1)	229
6.6.13.3 Mechanical Brake Slip Control	230
6.6.13.4 Brake Settings (Menu Index 5.12.2)	230
6.6.14 Additional Status Outputs (Menu Index 5.26)	234
6.6.14.1 General Digital Outputs (Menu Index 5.26.1)	234
6.6.15 Fieldbus Process Data (Menu Index 5.27)	235
6.6.15.1 Fieldbus Process Data Status (Menu Index 5.27.1)	235
6.6.16 Auxiliary Device Control (Menu Index 5.33)	237
6.7 Maintenance & Service (Menu Index 6)	237
6.7.1 Maintenance & Service Overview	237
6.7.2 Status (Menu Index 6.1)	237
6.7.2.1 Grid Status (Menu Index 1.1)	237
6.7.2.2 Power Conversion & DC Link Status (Menu Index 2.1)	240
6.7.2.3 Filters & Brake Chopper Status (Menu Index 3.1)	241
6.7.2.4 Motor Status (Menu Index 4.1)	242
6.7.2.5 Application Status (Menu Index 5.1)	245
6.7.2.6 Measured Temp. Protection Status (Menu Index 5.2.3.1)	249
6.7.2.7 Load Status (Menu Index 5.3.1)	250
6.7.2.8 Control Places Status (Menu Index 5.5.1)	250
6.7.2.9 Speed Control Status (Menu Index 5.8.1)	251
6.7.2.10 Torque Control Status (Menu Index 5.9.1)	254
6.7.2.11 Process Control Status (Menu Index 5.10.1)	255
6.7.2.12 Mechanical Brake Control Status (Menu Index 5.12.1)	256
6.7.2.13 Maintenance & Service (Menu Index 6.1.1)	257

6.7.3 Software Information (Menu Index 6.2)	258
6.7.4 Events (Menu Index 6.4)	258
6.7.4.1 Event Simulation (Menu Index 6.4.3)	258
6.7.4.2 Auto Reset (Menu Index 6.4.4)	259
6.7.5 Operational Counters (Menu Index 6.5)	260
6.7.6 Backup & Restore (Menu Index 6.7)	262
6.7.7 Preventive Maintenance (Menu Index 6.8)	262
6.7.7.1 Setting Up Preventive Maintenance	262
6.7.7.2 Preventive Maintenance Status (Menu Index 6.8.1)	263
6.7.7.3 Maintenance Request Notification and Acknowledging by Fieldbus	264
6.8 Functional Safety (Menu Index 7)	265
6.8.1 Functional Safety Overview	265
6.8.2 Status (Menu Index 7.1)	265
6.8.3 Basic Settings (Menu Index 7.2)	265
6.8.4 Safe Torque Off (STO)	266
6.8.5 STO (Menu Index 7.3)	266
6.8.6 Terminating STO and Resuming Normal Operation	267
6.8.7 SS1 (Menu Index 7.4)	267
6.9 Customization (Menu Index 8)	267
6.9.1 Customization Overview	267
6.9.2 Status (Menu Index 8.1)	267
6.9.3 Basic Settings (Menu Index 8.2)	268
6.9.4 Control Panel (Menu Index 8.3)	269
6.9.4.1 General Settings (Menu Index 8.3.1)	269
6.9.4.2 Status Line (Menu Index 8.3.2)	269
6.9.4.3 Status Screen 1 (Menu Index 8.3.3)	272
6.9.4.4 Status Screen 2 (Menu Index 8.3.4)	277
6.9.5 Date & Time (Menu Index 8.4)	282
6.9.6 Logic (Menu Index 8.5)	283
6.9.6.1 Status (Menu Index 8.5.1)	283
6.9.7 Preconfigured Parameter Sets (Menu Index 8.6)	284
6.10 I/O (Menu Index 9)	284
6.10.1 I/O Overview	284
6.10.2 Basic I/O	284
6.10.2.1 Basic I/O Status (Menu Index 9.3)	284
6.10.2.2 Digital Inputs/Outputs (Menu Index 9.4)	286
6.10.2.3 Analog Inputs/Outputs (Menu Index 9.5)	300

6.11 Connectivity (Menu Index 10)	305
6.11.1 Connectivity Overview	305
6.11.2 Communication interfaces (Menu Index 10.2)	305
6.11.2.1 Host Settings (Menu Index 10.2.1)	305
6.11.2.2 Ethernet Interface X0 (Menu Index 10.2.2)	305
6.11.2.3 Ethernet Interface X1/X2 Settings (Menu Index 10.2.3)	306
6.11.2.4 Ethernet port X0 (Menu Index 10.2.4)	307
6.11.2.5 Ethernet port X1 (Menu Index 10.2.5)	307
6.11.2.6 Ethernet port X2 (Menu Index 10.2.6)	308
6.11.2.7 Port Mirroring (Menu Index 10.2.7)	308
6.11.3 Protocols (Menu Index 10.3)	308
6.11.3.1 General Settings (Menu Index 10.3.1)	308
6.11.3.2 PROFINET (Menu Index 10.3.2)	310
6.11.3.3 Modbus (Menu Index 10.3.3)	311
6.11.3.4 EtherNet/IP (Menu Index 10.3.4)	312
6.11.3.5 EtherCAT (Menu Index 10.3.5)	313
6.11.3.6 OPC UA (Menu Index 10.3.6)	313
7 Troubleshooting	
7.1 Viewing Warnings	314
7.2 Viewing and Resetting Faults	314
7.3 Reading the Event Summary Table	314
7.4 Events Summary for Industry Application Software	315

1 Introduction to the Application Guide

1.1 Version History

This guide is regularly reviewed and updated. All suggestions for improvement are welcome.

The original language of this guide is in English.

Version	Remarks	Software Version
M00104, document version 07	General Release 4	4.3.0
M00104, document version 06	General Release 3	4.2.9

1.2 Purpose of this Application Guide

This application guide is intended for qualified personnel such as:

- Automation engineers
- Commissioning engineers who have experience operating with parameters and basic knowledge of AC drives

The application guide provides information on the initial configuration of the drive. The purpose of the guide is to provide information on parameters for configuring and controlling the drive, an overview and procedures of the various user interfaces in iC7, typical application examples, and troubleshooting of events in the drive.

1.3 Additional Resources

Additional resources are available with related information.

iC7-Automation Frequency Converters Design Guide provides information about the capability and functionality to design motor control systems for Danfoss iC7 series.

iC7 Series Frequency Converters Installation Safety Guide provides important safety information related to iC7 drives.

iC7-Automation Frequency Converters Installation Guides cover the mechanical and electrical installation of drives.

1.4 Safety Symbols

The following symbols are used in Danfoss documentation.

DANGER

Indicates a hazardous situation which, if not avoided, will result in death or serious injury.

WARNING

Indicates a hazardous situation which, if not avoided, could result in death or serious injury.



CAUTION

Indicates a hazardous situation which, if not avoided, could result in minor or moderate injury.

NOTICE

Indicates information considered important, but not hazard-related (for example, messages relating to property damage).

The guide also includes ISO warning symbols related to hot surfaces and burn hazard, high voltage and electrical shock, and referring to the instructions.

	ISO warning symbol for hot surfaces and burn hazard
	ISO warning symbol for high voltage and electrical shock
	ISO action symbol for referring to the instructions

2 Industry Application Software Overview

2.1 Industry Application Overview

The iC7-Automation is delivered with the Industry application software as standard. The Industry application software offers a wide range of features supporting a large selection of generic applications. The features are briefly described in the following sections.

2.2 Basic Functions

2.2.1 I/O Control and Statuses

Depending on the hardware configuration of the drive, digital and analog inputs as well as digital, analog, and relay outputs are available. The I/Os can be configured and used to control the application from the drive.

If functional extension options are installed in the drive, the relevant parameters and I/O selections are automatically visible in the parameter structure.

2.2.2 Reference Handling

References from multiple sources can be defined, depending on the needs of the application.

Reference sources are:

- Analog inputs
- Digital inputs as pulse input
- Fieldbus
- Up to 8 speed presets, 4 torque presets, or 8 process presets, each individually configurable (selectable by parameter, fieldbus, or digital inputs)
- Local reference from control panel
- Logic reference

Reference signals can be individually configured and scaled for every operating mode (speed, torque, and process). They can be added, subtracted, and multiplied, generating the reference to the drive.

2.2.3 Ramps

The application supports 4 linear and S-ramps, a variable ramp that can be adjusted with an analog value, and the anti-sway ramp that prevents the swaying of a load during horizontal movement.

Linear ramps provide a constant acceleration and deceleration. S-ramps provide a non-linear acceleration and deceleration, with a soft transition at the start and end of the acceleration and deceleration process.

2.2.4 Quick Stop

In some situations, it may be required to stop the application quickly. For this purpose, the drive supports a specific deceleration ramp time from the synchronous motor speed to 0 RPM.

2.2.5 Limit Rotation Direction

The motor can be preset to run in 1 rotational direction only (positive or negative), avoiding unintended rotation direction.

2.2.6 Inching with Jogging Modes

Predefined speed settings are available for use during commissioning, maintenance, or service. The settings include Slow Down mode (operating at decreased speed), Jogging mode (operating at a preset speed), and Override mode (this mode overrides any reference settings).

2.2.7 Speed Bypass

Specific motor speeds can be bypassed during operation. The feature helps to minimize or avoid mechanical resonance of the machine, limiting the vibration and noise of the system.

2.2.8 Flying Start

Flying start enables the drive to synchronize to a freely spinning motor, before taking control of the motor. Taking over control of the motor at the actual speed minimizes mechanical stress to the system. This feature is relevant in fan and centrifuge applications, for example.

2.2.9 Mains Dropout

If there is a mains dropout and the drive cannot continue operation, it is possible to select predefined corrective actions. These actions include a trip, coasting, or performing a controlled ramp down.

2.2.10 Kinetic Backup

Kinetic backup enables the drive to remain in control in the event of a power outage if there is sufficient energy in the system, such as inertia or when lowering a load. The function allows a controlled stop of the machine.

2.2.11 Resonance Damping

High-frequency motor resonance noise can be eliminated by using resonance damping. Both automatic and manually selected frequency damping is available.

2.2.12 Motor Preheating

In cold and damp environments, the motor must be preheated to avoid condensation and cold starts. The feature DC Start generates a DC current through the motor windings, keeping the temperature above the surrounding temperature.

2.2.13 Mechanical Brake Control

In applications like cranes, lifts and hoists, or downhill conveyors, a mechanical brake is used to keep the load at standstill when the motor is not controlled by the drive or when power is turned off.

The mechanical brake control feature ensures a smooth transition between the mechanical brake and the motor holding the load, by controlling the activation and deactivation of the mechanical brake.

2.2.14 Load Drooping

The load drooping function ensures that multiple motors, each controlled by a drive and connected to a common mechanical shaft, share the load. The function is typically used in cranes, winches, or larger conveyor systems controlled by 2 or more motors.

2.3 Controllers

2.3.1 Speed Controller

A built-in speed PI controller provides accurate control of the rotational speed of the motor. The controller offers control in both open and closed-loop configuration.

Open-loop mode does not require an external sensor for measuring the feedback signal. This allows easy installation and commissioning and eliminates the risk of defective sensors.

In closed-loop mode, a speed sensor is added, offering highly accurate control.

The parameters of the speed controller can be optimized by the built-in **auto tuning** function.

2.3.2 Torque Controller

A built-in torque controller provides optimized control of torque. Typical use cases are in tension control for winches or extruders. The drive offers both open-loop control where the current sensors provide the feedback and a closed-loop control with feedback provided by an external speed sensor.

2.3.3 Process Control

The process controller can control a process in a system where a constant pressure, flow, or temperature is needed, for example. Feedback from the application is connected to the drive, providing the actual process value. The controller ensures that the output matches the desired speed reference. The reference source and the feedback signals are converted and scaled to the actual values controlled. The controller provides full PID control, which includes PID parameter configuration, and is optimized by the built-in auto-tuning function.

2.4 Motor Control Features

2.4.1 Motor Types

The drive supports standard available motors, such as:

- Asynchronous motors
- Permanent magnet motors

2.4.2 Torque Characteristics

Different load characteristics are supported to match the actual application needs:

- **Variable torque:** Typical load characteristic of fans and centrifugal pumps, where the load is proportional to the square of the speed.
- **Constant torque:** Load characteristic used in machinery where torque is needed across the full speed range. Typical applications are conveyors, extruders, decanters, compressors, and winches.

2.4.3 Motor Control Principles

Different control principles can be selected to control the motor, matching the needs of the application:

- U/f control for simple open-loop operation.
- VVC+ (Voltage Vector Control) in both open and closed loop, for general-purpose application needs.
- FVC+ (Flux Vector Control) in both open and closed loop, for demanding applications that need fast responses or high speed or torque accuracy.

2.4.4 Motor Nameplate Data

Typical motor data for the drive are preset at the factory, matching the size of the drive. The preset data allow operation of most motors. During commissioning, actual motor data are entered in the settings of the drive to optimize motor control.

2.4.5 Automatic Motor Adaptation (AMA)

Automatic Motor Adaptation (AMA) optimizes motor parameters for improved shaft performance and energy efficiency. Based on motor product label data and measurements of the motor at standstill, key motor parameters are recalculated to fine-tune the motor control algorithm.

2.4.6 Automation Energy Optimization (AEO)

The Automatic Energy Optimization (AEO) feature optimizes control with focus on lowering energy consumption at the actual load point.

2.5 Braking of Load

2.5.1 Overview of Braking of Load

For controlled load braking performed by the drive, various functions can be used. The specific function is selected based on the application and how fast the load has to be stopped.

2.5.2 Resistor Braking

In applications that require fast or continuous braking, a drive fitted with a brake chopper is typically used. Excess energy, generated by the motor during the braking of the application, is dissipated in a connected brake resistor.

2.5.3 Overvoltage Control (OVC)

If braking time is not critical or the load is varying, the overvoltage control (OVC) feature can be used to control the stopping of the application. The drive extends the ramp-down time when it is not possible to brake within the defined ramp-down period. This feature must not be used in hoisting applications, high inertia systems, or applications where continuous braking is required.

2.5.4 DC Brake

The DC brake feature is useful when braking at low speed. The drive offers configurable DC-braking for induction motor control. It injects a user-defined DC current.

2.5.5 AC Brake

In applications where the operation of the motor is non-cyclic, AC braking can be used to shorten the braking time. Excess energy is dissipated by increasing losses in the motor during braking. Performance is motor type dependent and offers best performance on asynchronous motors.

2.5.6 DC Hold

The drive offers the possibility to configure the feature DC Start for DC holding before entering normal motor control.

2.5.7 Load Sharing

In some applications, 2 or more drives control the application at the same time. If 1 of the drives is braking a motor, the excess energy can be fed to the DC link of a drive driving a motor, which results in a reduction of the total energy consumption. This feature is typically useful in, for example, decanters and carding machines, where smaller power-sized drives operate in generator mode.

2.6 Protection Features

2.6.1 Grid Protection

The drive protects the application against conditions in the power grid that can affect proper operation. The grid is monitored for phase imbalance and phase loss. When the imbalance exceeds specified limits, the drive issues a configurable response and appropriate actions can be taken.

The supply frequency is also monitored, and when it is outside acceptable limits, the drive responds in the configured way. Furthermore, the drive offers protections against low and high voltages.

2.6.2 Drive Protection

The drive monitors and protects itself at all times.

Inbuilt temperature sensors measure the temperature of relevant components. If the temperature is close to the maximum, derating of operational parameters is applied to keep the application running, though at a lower performance level. If the temperature is outside the allowed operating range, the drive stops operation.

The motor current is continuously monitored on all 3 phases. If there is a short circuit between 2 phases, or to ground, the drive detects the short circuit and immediately turns off. If the output current is exceeding its nominal values during operation for longer periods than allowed, the overload capability is reduced until the conditions are restored.

The DC-link voltage of the drive is monitored. If it exceeds critical levels, the drive issues a warning. If the situation is not resolved, the drive stops operation.

2.6.3 Motor Protection

The drive provides various features to protect the motor, and indirectly the application.

The output current measurement provides information to protect the motor. Overcurrent, short circuit, ground faults, and lost motor phase connections can be detected and relevant protections initiated.

The monitoring of speed, current, and torque limits provides an extra protection for the motor and the application. Under extreme load conditions, it also provides motor stall protection.

Locked-rotor protection secures that the drive does not start when the rotor of the motor is blocked.

Motor thermal protection is provided either as a calculation of the motor temperature based on the actual load, or by external temperature sensors connected to the drive. Supported sensor types are Pt100, Pt1000, Ni1000, KTY84, and KTY81.

2.6.4 Protection of External Filters or Brake Resistors

Brake resistors are monitored for thermal overload (by calculated thermal load or an external sensor), short circuit, and missing connections.

The drive can also monitor the temperature of externally connected filters.

2.6.5 Automatic Derating

Automatic derating of the drive allows continued operation even if the nominal operation conditions are exceeded. It is a response to exceeded limits in the grid, motor, and self protection features of the drive. Typical factors affecting operation are high temperature, high DC-link voltage, high motor load, or operation close to 0 Hz. Derating is typically applied as a reduction in switching frequency or change in switching pattern, resulting in lower thermal losses.

2.7 Monitoring, Logging, and History Log

2.7.1 Monitoring Features

The drive offers a wide range of monitoring features that provide information of actual operating conditions. Some examples are:

Speed monitoring

The motor speed can be monitored during operation. If the speed exceeds minimum or maximum limits, the user is notified and can initiate appropriate actions.

Temperature monitoring

Temperatures of the drive and external connected sensors can be monitored. This way you can monitor the operational conditions of the drive and the related application.

Grid monitoring

During operation, the drive is able to monitor the grid conditions. It measures the grid voltage for each supply phase and the grid frequency, and calculates the grid voltage imbalance and total harmonic distortion (THDv).

2.7.2 Event Log

An event log provides access to the latest registered warnings and faults, providing relevant information for analysis of the events that occur in the drive.

2.7.3 Logging and Storage of Data

Logging of operational data from the drive and the related process is possible during running. Logging can be continuous or triggered by specific events. Data is stored to the microSD card placed in the drive, or transferred directly to MyDrive Insight. This feature provides the opportunity to collect data for a detailed analysis of operation and the events happening during operation.

2.7.4 Preventive Maintenance

Elements in the application must be inspected and serviced periodically because of wear and tear during operation. For example, motor bearings, feedback sensors, seals, and filters are subject to wear and must be serviced or replaced. With preventive maintenance, the service intervals can be programmed into the drive. The drive issues a warning when maintenance is required.

10 preventive maintenance items can be programmed into the drive. The following information must be specified for each item:

- The type of the trigger that activates the maintenance (for example Running hours)
- Maintenance interval (for example 1000 hours)

The parameters can also be set individually via fieldbus.

2.8 Functional Safety

A Safe Torque Off function with dual input is available as standard in the drive. An additional Safe Torque Off feedback signal indicates the status of the drive.

More functional safety features are available as optional selections. The set of features covers a wide range of functional safety functions that can operate in both sensorless and closed-loop setup. A safe fieldbus is also supported as option.

2.9 Software Tools

2.9.1 Overview of Software Tools

Danfoss offers a suite of desktop software tools which have been designed to provide easy operation and the highest level of customization of AC drives.

APIs and the Danfoss Device Interface make it possible to integrate the tools into proprietary systems and business processes. The MyDrive® tools support the entire life cycle of the drive, from system design to service. Some of the tools are available free of charge, and some require a subscription.

For more information about the MyDrive® tools, see MyDrive documentation.

2.9.2 MyDrive® Select

MyDrive® Select performs frequency converter sizing based on calculated motor load currents, ambient temperature, and current limitations. The sizing results are available in graphical and numerical format, and include calculations of efficiency, power losses, and inverter load currents. The resulting documentation is available in .pdf or .xls format, and can be imported to MyDrive® Harmonics for evaluation of the harmonic distortion, or validation of compliance towards most recognized harmonic norms and recommendations.

MyDrive® Select is available as a web-based tool at select.mydrive.danfoss.com and as a mobile device app that can be downloaded from app stores.

2.9.3 MyDrive® Harmonics

MyDrive® Harmonics estimates the benefits of adding harmonic mitigation solutions to an installation and calculates system harmonic distortion. The evaluation can be done both for new installations and when extending an existing installation.

The free version provides a fast overview of the expected general performance of the system. The expert version of MyDrive® Harmonics requires a subscription, which opens up more features, including the possibility to save and share harmonic projects, import projects from MyDrive® Select, and the possibility to add Danfoss harmonic mitigation products.

MyDrive® is available as a web-based tool at <https://harmonics.mydrive.danfoss.com>.

2.9.4 MyDrive® ecoSmart™

MyDrive® ecoSmart™ determines the energy efficiency of the drive being used and the system efficiency class according to IEC 61800-9.

MyDrive® ecoSmart™ uses information about the selected motor, load points, and AC drive to calculate the efficiency class and part load efficiency for a Danfoss AC drive, either for a free-standing drive (CDM), or a drive with a motor (PDS).

MyDrive® ecoSmart™ is available as a web-based tool at ecosmart.mydrive.danfoss.com and as a mobile device app that can be downloaded from app stores.

2.9.5 MyDrive® Insight

MyDrive® Insight is a software tool for commissioning, engineering, and monitoring drives. MyDrive® Insight can be used to configure parameters, upgrade software, and set up functional safety features and condition-based monitoring. A microSD card can be used as a storage device for data logging, making backups, and restoring the system from a backup.

The Logic feature in MyDrive® Insight enables the customization and control of drives through a graphical user interface without the need for a separate programming tool. It allows for conditional controls, fault detection and diagnostics, and the creation of sequencing and interlocking logic. Programmable function blocks with inputs and outputs can be connected to control the digital or analog outputs of the drive. For more information, see MyDrive® Insight Logic Feature Application Guide.

MyDrive® Insight is available for download at <https://suite.mydrive.danfoss.com>.

2.10 Security Features

NOTICE

Do not connect the drive directly to the internet, as end-to-end connectivity is not secured via Danfoss software tools. It is recommended that drives are installed by authorized and educated personnel, who are aware of the security risks in networks and can mitigate threats in the network. Typically, the drive can be accessed and configured by anyone with physical access.

The drive provides the following cybersecurity features:

- Secure boot chain
- Signed and encrypted firmware and application software
- Secure software updates
- License verification
- Secure connectivity for all communication interfaces

2.11 Motor Control Features for FVC+ and VVC+ Control

2.11.1 Compatibility of Motor Control Features for FVC+ and VVC+ Control

The following table outlines the compatibility of motor types and motor control related features with motor control principles.

Table 1: Motor Control Features and Motor Types

Motor type/Feature		Induction motors		Synchronous motors	
		FVC+	VVC+	FVC+	VVC+
Motor type	Induction motor (IM)	X	X	-	-
	Surface permanent magnet motor (SPM)	-	-	X	X
	Interior permanent magnet motor (IPM)	-	-	X	X
Speed feedback	Open loop	X	X	X	X
	Closed loop (with Encoder Resolver option)	X	X	X	-
Reference handling	Speed control	X	X	X	X
	Torque control	X	-	X	-
	Linear ramp	X	X	X	X
	S-ramp	X	X	X	X
	Load drooping	X	X	X	X
	Windowing in torque control	X	-	X	-
Limit handling	Speed limit	X	X	X	X
	Torque limit	X	X	X	X
	Current limit	X	X	X	X
	Power limit	X	X	X	X
	Overvoltage control	X	X	X	X
	Undervoltage control	X	X	X	X
Auxiliary functions	Flying start	X	X	X	X
	Automatic energy optimization (AEO)	X	X	X	X
	Power loss action	X	X	X	X
	AC brake (Flux brake)	X	X	X	-
	Start magnetization	X	X	-	-
	DC brake	X	X	X	X
	DC-injection in stop	X	X	X	X
	Stop state magnetization	X	X	-	-
	Initial position detection	-	-	X	X
	Rotor parking	-	-	X	X

Table 1: Motor Control Features and Motor Types (continued)

Motor type/Feature		Induction motors		Synchronous motors	
		FVC+	VVC+	FVC+	VVC+
Commissioning functions	AMA standstill	X	X	X	X
	Inertia measurement	X	-	X	-
	Speed control auto-tuning	X	-	X	-
Filters	Sine-wave filter	-	X	-	-
	Advanced harmonic filter	X	X	X	X
Process functionality and protections	Mechanical brake control	X	-	X	-
	Missing motor phase	X	X	X	X
	External motor thermal protection	X	X	X	X
	Electronic thermal relay (ETR)	X	X	X	X

2.11.2 High Frequency Voltage Injection

For salient pole synchronous motors under FVC+, High Frequency Voltage Injection (HFVI) is an encoder/resolver alternative for rotor position detection at low speeds. If the motor has sufficient saliency (typically larger than 1.1), HFVI allows applications to run open loop with performance like closed loop.

In a salient pole motor, the magnetic material of the rotor is not rotationally symmetric, as opposed to a non-salient pole motor where it is. That means that the magnetic path through different diameters of the rotor varies. This variation results in different values of L_q and L_d inductances, which can be used to determine the orientation of the rotor. The saliency ratio (SR) is the ratio between L_q and L_d .

Commissioning HFVI

A typical HFVI commissioning workflow is:

1. Set **4.3.1.1 Motor Control Principle** to FVC+.
2. Enter the product label data to **4.2.4 Permanent Magnet Motor** and set **4.2.1.1 Motor Type**.
3. Run full AMA: Set **4.2.1.4 Ama Mode** to Motor Data and start the drive.
4. Enable HFVI by setting **4.3.3.4 Low Speed Mode**.

While HFVI is enabled, the saliency ratio is validated.

Table 2: Saliency ratios

Saliency ratio (L_q/L_d)	Drive response
$SR \leq 1.1$	Motor start prevented.
$1.1 < SR < 1.5$	Warning issued in the event log. Tracking capabilities are possibly reduced.

HFVI parameters

The setup parameters are all located under **4.3.3 FVC+ Settings** in the **4.3 Motor Control** menu. HFVI is enabled by setting **4.3.3.4 Low Speed Mode** (1 in the following picture) to HF Injection.

①	4.3.3.4	Low Speed Mode	Normal Motor Control	Normal Motor Control	0	3	
	4.3.3.5	I/f Control Current %	100	100	0	500	%
	4.3.3.6	I/f Control Threshold Speed	10	300	1	50	rpm
	4.3.3.7	Low Speed Minimum Current	50	50	0	100	%
	4.3.3.8	Minimum Current Threshold Speed	10	10	1	50	Hz
	4.3.3.9	Motor Feedback Mode	Open Loop	Open Loop	0	1	
②	4.3.3.10	HF Inject Voltage Gain %	100	100	5	2000	%
③	4.3.3.11	HF Inject Bandwidth %	100	100	1	1000	%
④	4.3.3.12	HF Inject Angle Comp Gain	0	0	-35	35	°
⑤	4.3.3.13	HF Inject Angle Comp Offset	0	0	-25	25	°
⑥	4.3.3.14	HF Inject Frequency	0	0	0	3.4028234663852886e+38	Hz
⑦	4.3.3.15	IdIq Reference Ratio Pct	0	0	-100	100	%

Figure 1: HFVI parameters

The basic settings are done with the following 3 parameters:

- **4.3.3.10 HF Inject Voltage Gain % (2):** Set the magnitude of the injected voltage as a percentage of the recommended injected voltage.
- **4.3.3.11 HF Inject Bandwidth % (3):** Set the bandwidth of the position estimation as a percentage of the recommended bandwidth.
- **4.3.3.14 HF Inject Frequency (6):** This is an optional parameter to force the injection frequency to a specific value. If set to 0, the recommended injection frequency is used.

The recommended injected voltage and frequency are calculated based on motor data.

To ensure sufficient saliency levels under all load conditions, more advanced settings can be set with these 3 parameters:

- **4.3.3.12 HF Inject Angle Comp Gain (4):** Load-dependent offset to the estimated rotor angle.
- **4.3.3.13 HF Inject Angle Comp Offset (5):** Offset to the estimated rotor angle.
- **4.3.3.15 IdIq Reference Ratio Pct (7):** Disables the existing magnetization current controlling scheme, like MTPA, and introduces a magnetization current as a percentage of the torque current. This parameter can be used to force the motor to run with elevated magnetization current levels, if it is required to ensure sufficient saliency levels.

These 3 parameters require detailed information about the motor flux at various operating conditions.

2.12 PROFIdrive - Standard Telegram 1

2.12.1 Overview

Standard telegram 1 is implemented according to PROFIdrive Application Class 1 profile as defined in the PROFIdrive standard and state machine diagram. It can be used with iC7 series motor applications.

2.12.2 Control Word

Table 3: Control Word Bits in PROFIdrive Standard Telegram 1

Bit number	Name	Description
0	On-Off	1: On. 0: Off.
1	Coast stop	1: No coast stop. 0: Coast stop.

Table 3: Control Word Bits in PROFIdrive Standard Telegram 1 (continued)

Bit number	Name	Description
2	Quick stop	1: No quick stop. 0: Quick stop.
3	Operation	1: Enable operation. 0: Disable operation.
4	Ramp generator	1: Enable ramp generator (RFG). 0: Reset ramp generator. Output of the RFG is set to 0. The drive decelerates along the current limit or along the voltage limit of the DC link.
5	Freeze	1: Unfreeze ramp generator. 0: Freeze ramp generator. Freezes the present output frequency (in Hz).
6	Enable setpoint	1: Enable setpoint. 0: Disable setpoint.
7	Fault acknowledge	0 ⇒ 1: Acknowledge faults. ⁽¹⁾ 0: No function.
8	Jog 1	1: Jog 1 on. 0: Jog 1 off. Operation is enabled, drive is at standstill, and STW1 bit 4, 5, 6: 0. The drive runs up along the ramp to jogging setpoint 1.
9	Jog 2	1: Jog 2 on. 0: Jog 2 off. Operation is enabled, drive is at standstill, and STW1 bit 4, 5, 6: 0. The drive runs up along the ramp to jogging setpoint 2.
10	Control by PLC	1: Uses process data (control by PLC). 0: Ignores the current process data. This is linked to a submodule where the CTW is present. If signals are to be covered, the CTW/STW profile (for example, the iC Speed Profile) must be part of the signals list.
11	–	Reserved
12	User defined	These bits are reserved for application-specific advanced control. For more information, refer to the <i>Parameter Descriptions</i> chapter in the application guide.
13	User defined	
14	User defined	
15	User defined	

1) Acknowledging is edge-triggered, when changing from logic 0 to logic 1.

2.12.3 Status Word (STW) in PROFIdrive Standard Telegram 1

Table 4: Status Word Bits in PROFIdrive Standard Telegram 1

Bit number	Name	Description
0	Ready to switch on	1 = Ready to switch on. 0 = Not ready to switch on.
1	Ready to operate	1 = Ready to operate. 0 = Not ready to operate.

Table 4: Status Word Bits in PROFIdrive Standard Telegram 1 (continued)

Bit number	Name	Description
2	Operation enabled	1 = Operation enabled. 0 = Operation disabled.
3	Operation fault	1 = Fault present. 0 = No fault.
4	Coast stop	1 = Coast stop not activated (No OFF2). 0 = Coast stop activated (OFF2).
5	Quick stop	1 = Quick stop not activated (No OFF3). 0 = Quick stop activated (OFF3).
6	Switching on inhibited	1 = Switching on inhibited. 0 = Switching on not inhibited.
7	Warning	1 = A warning has occurred. 0 = There are no warnings.
8	Speed=reference/Speed<>reference	1 = The current motor speed matches the current speed reference within a given tolerance. The tolerance is product specific. The motor runs, but the current speed is different from the current speed reference. This can happen, for example, when the speed ramps up or down during start or stop.
9	Bus control/Local operation	1 = The device is controlled and reacting to I/O and process data. 0 = The device does not react on commands from fieldbus, because of one of the following reasons: <ul style="list-style-type: none"> • CTW bit 10 = 0. • HMI is in local mode. • MyDrive® Insight has taken control. • Control places do not include fieldbus.
10	Frequency limit ok/Out of frequency limit	1 = The output frequency is within the defined motor limits. 0 = The output frequency has exceeded the defined motor limits given by parameters. The speed limits are set by these parameters: <ul style="list-style-type: none"> • <i>P 5.8.3.4 High Speed Warning</i> • <i>P 5.8.3.9 Low Speed Monitor Limit</i>
11	User defined	These bits enable the mapping of application functionality of the drive to the status word. Mapping is done through parameters. For more information, refer to the Parameter Descriptions chapter in the application guide.
12	User defined	
13	User defined	
14	User defined	
15	User defined	

2.12.4 PROFIdrive State Machine

In the PROFIdrive control profile, the control bits perform different functions:

- 0–3 perform the basic startup and power-down functions.
- 4–10 perform application-oriented control.
- 12–15 can be configured for different purposes.

See [Figure 2](#) for the basic state transition diagram, where control bits 0–3 control the transitions and the corresponding status bit indicates the actual state. The black dots indicate the priority of the control signals. Fewer dots indicate lower priority, and more dots indicate higher priority.

The general state diagram is defined in the PROFIdrive standard.

e30bk784.10

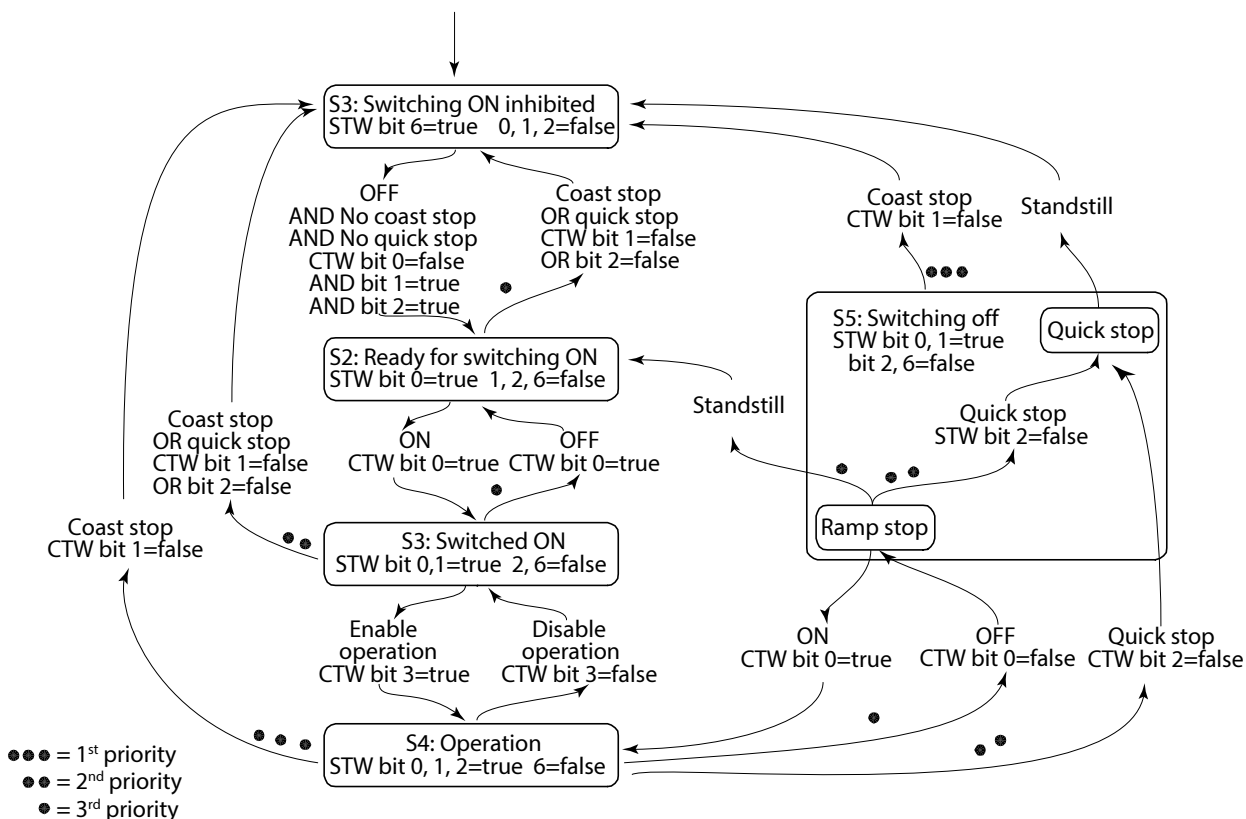

Figure 2: General State Diagram

2.13 iC Speed Profile

2.13.1 Overview

The iC Speed profile is used with the iC7 series motor applications. The iC Speed profile differs from the PROFIdrive profile, because it does not have a State Machine. It is only controlled by the actual state 1/0 of the control bits, not the sequence in which they are manipulated.

2.13.2 Control Word

Table 5: iC Speed Profile Control Word Bits

Bit number	Name	Description
0+1	Preset reference selector	00: Preset reference 1 01: Preset reference 2 10: Preset reference 3 11: Preset reference 4
2	Reserved	Reserved for future use. Any control words sent to the device should keep this bit at 0 to ensure compatibility with future extensions of the control word.
3	No coast/Coast	1: No function. 0: Causes the drive to immediately coast the motor.
4	No quick stop/Quick Stop	1: No function. 0: Quick stops the drive and ramps down the motor speed to stop as defined with the quick stop ramp parameter.
5	No hold/Hold output frequency	1: No function. 0: Hold the present output frequency (in Hz).
6	Start/No start	1: If the other starting conditions are fulfilled, this selection allows the drive to start the motor. 0: Stops the drive and ramps down the motor speed as defined with the ramp down parameter.
7	Reset	0 ⇒ 1: Acknowledge faults. ⁽¹⁾ 0: No function.
8	Jog/No jog	1: Sets the output frequency to the jog speed defined with the jog speed parameter. 0: No function.
9	Ramp select	1: Ramp 2 is active. 0: Ramp 1 is active.
10	Data valid	1: Use process data (control by PLC). 0: Ignore the current process data. This is linked to the submodule where the CTW is present. If signals are to be covered, the CTW/STW profile (for example, the iC Speed Profile) must be part of the signals list. Use the previously processed data when the data valid bit was true (no control by PLC).
11	Reserved	Reserved for future use.
12	User defined	These bits are reserved for application-specific advanced control. For more information, refer to the <i>Parameter Descriptions</i> chapter in the application guide.
13	User defined	
14	User defined	
15	User defined	

¹⁾ Acknowledge is edge-triggered, when the logic is changed from 0 to 1. Faults can only be acknowledged if the triggering condition has been removed and any required acknowledgment has been done.

2.13.3 Status Word (STW) in iC Speed Profile

Table 6: iC Speed Profile Status Word Bits

Bit number	Name	Description
0	Control ready	1 = The device controls are ready and react to process data. 0 = The device controls are not ready and do not react to process data.
1	Frequency converter ready	1 = The frequency converter is ready for operation. 0 = The frequency converter is not ready for operation. This status does not involve faults and warnings as they are indicated in their respective bits elsewhere.
2	Coast	1 = There are no active coast signals, and the motor can start when a start signal is given. 0 = The frequency converter has an active coast signal and has released the motor.
3	Fault	1 = A fault has occurred, and an acknowledge signal is required to re-establish operation. 0 = There are no faults.
4	Reserved	Reserved.
5	Reserved	Reserved.
6	Reserved	Reserved.
7	Warning	1 = A warning is active. 0 = There are no warnings.
8	Speed=reference	1 = The current motor speed matches the current speed reference within a given tolerance. The tolerance is product specific. 0 = The motor runs, but the current speed is different from the current speed reference, for example while the speed ramps up or down during start or stop.
9	Bus control/Local operation	1 = The device is controlled and reacting to I/O and process data. 0 = The device does not react on commands from the fieldbus, for 1 of the following reasons: <ul style="list-style-type: none"> • CTW bit 10 = 0. • HMI is in local mode. • MyDrive® Insight has taken control. • Control places do not include fieldbus.
10	Frequency limit	1 = The output frequency is within the defined motor limits. 0 = The output frequency has exceeded the defined motor limits. The speed limits are set with the parameters: <ul style="list-style-type: none"> • <i>P 5.8.3.1 Positive Speed Limit</i> • <i>P 5.8.3.2 Negative Speed Limit</i> • <i>P 5.8.3.3 Minimum Speed Limit</i>
11	Operation	1 = The process is running, and the motor can be running or start at any time. 0 = There are no active start requests, and the process does not run. The motor is coasted and is not started.
12	Reserved	Reserved.

Table 6: iC Speed Profile Status Word Bits (continued)

Bit number	Name	Description
13	Reserved	Reserved.
14	User defined	These bits are reserved for application-specific advanced control. For more information, refer to the Parameter Descriptions chapter in the application guide.
15	User defined	

3 User Interfaces

3.1 Overview of User Interfaces

To interact with a Danfoss iC7 Series drive, use either the control panel as a simple and direct interface, or the software tool MyDrive® Insight for more advanced interaction with the drive. The control panel can be mounted directly on the drive, or close to the drive by using a control panel mounting kit.

With MyDrive® Insight the drive can be accessed from a remote place, if the infrastructure is in place and the network provides the required access rights.

3.2 Control Panel

3.2.1 iC7 Control Panel Options

The iC7 series offers a broad range of interfaces which suit different connectivity requirements to support wireless regulations.

The iC7 Series offers the following 2 different control panel options. Refer to the relevant Design Guide for information on which control panels are available to your product.

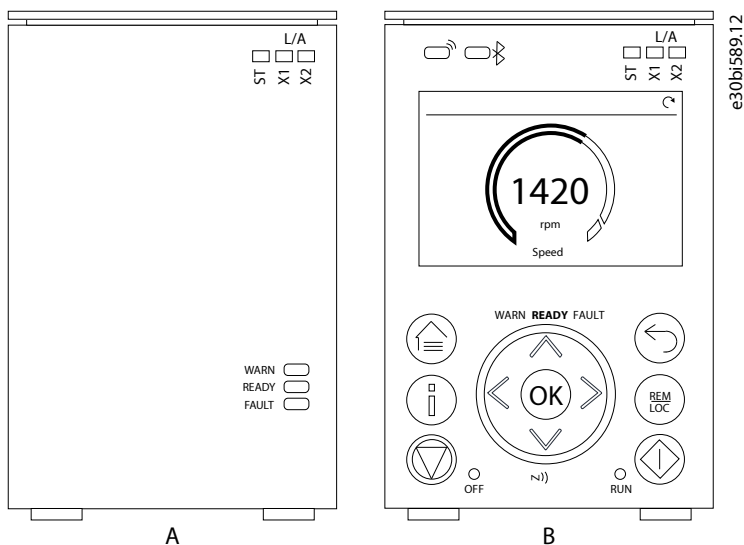

Figure 3: Control Panel Options

- **Blind Panel OPX00:** This panel shows the basic status of the drive and fieldbus indicators. The panel is typically used when only limited interaction with the drive is required after installation and commissioning, or when the drives are controlled by fieldbus.
- **Control Panel 2.8 OPX20:** This panel is the standard user interface, and used when frequent interaction with the drive is required. The panel enables easy setup of the drive via parameters, monitoring the drive status, and also shows event notifications.

Control Panel 2.8 OPX20 has the following features:

- 2.8" monochromatic user interface with a display resolution of 240 x 160 pixels.
- Visual LEDs to illustrate drive status and fieldbus communication.
- Halo indicator with 3 colors to illustrate drive status at a glance.
- A display which can be customized to show required or essential information.
- Buttons to control the drive locally, including a toggle button to easily switch between local and remote control.
- Parameter widgets which support alphanumeric and special characters, integers, floating points, date time formats, choice lists, and commands to configure application data.
- Help texts to support operation.

3.2.2 Control Panel Elements

The control panel provides an interface for configuring and controlling the converter easily. The section describes the elements for all control panel options.

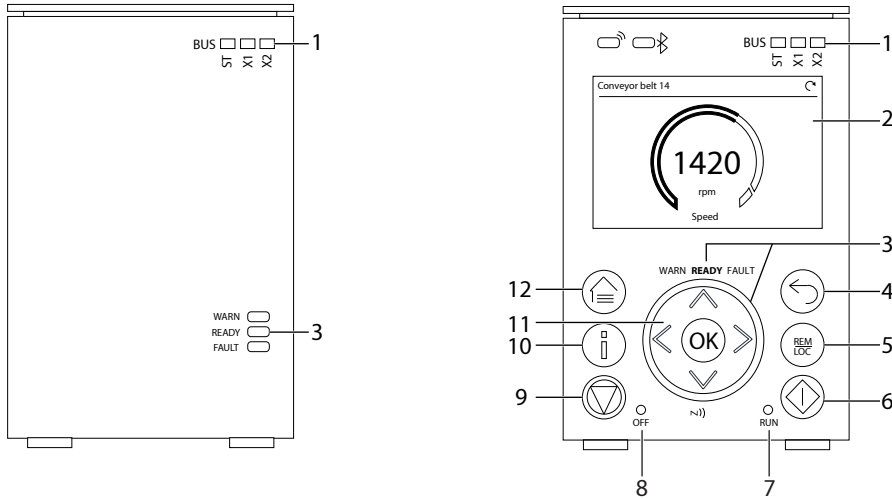

e30b7/69.12

Figure 4: Control Panel Elements

The following table describes the control panel elements:

Table 7: Control Panel Elements Description

Legend	Name of Element	Description
1	Fieldbus Indicators	<p>The LEDs indicate the status of the communication interface X1 and X2.</p> <ul style="list-style-type: none"> • [ST] <ul style="list-style-type: none"> -Green blinking LED indicates that the communication interfaces are in normal operating state. -Red blinking LED indicates that an error has occurred and communication is not possible. • [X1] <ul style="list-style-type: none"> -Green blinking LED indicates data exchange on communication interface X1. -Red blinking LED indicates an error during data exchange on communication interface X1. • [X2] <ul style="list-style-type: none"> -Green blinking LED indicates data exchange on communication interface X2. -Red blinking LED indicates an error during data exchange on communication interface X2.
2	Display	<p>Enables access to content and settings. The display provides detailed information about the status of the converter.</p>

Table 7: Control Panel Elements Description (continued)

Legend	Name of Element	Description
3	Converter Status Indicators	<p>The LEDs indicate the status of the converter.</p> <ul style="list-style-type: none"> • [WARN] -When this text is lit in yellow, it indicates a warning-level event. • [READY] -When this text is lit in white, it indicates that the converter is ready for operation. -When this text is blinking white (1 Hz), it indicates that the converter is powered on but is not ready. • [FAULT] -When this text is lit in red, it indicates a fault. <p>The status of the converter is also indicated by the Halo, which has the same color indicators as the converter status texts on the control panel.</p>
4	Back button	Navigates to the previously viewed screen or a menu level above the current menu.
5	REM/LOC	Toggles the converter between remote and local operation.
6	Run button	Starts the operation of the converter.
7	RUN LED	<p>The indicator has the following states:</p> <ul style="list-style-type: none"> • On: Start command is applied and the converter is modulating. • Off: The converter has stopped and the start command is not applied.
8	OFF LED	<p>The indicator has the following states:</p> <ul style="list-style-type: none"> • Steadily on: The indicator is in this state because of either of the following 2 reasons: <ul style="list-style-type: none"> -The converter is not modulating and is coasted. -The stop signal is applied, output is active, and the converter is ramping down until coast or restart. Ramp times, protections, and stopping functions prolong this state. • Flashes for 3 seconds: Indicates that the start command is initiated, but the converter is not able to start. • Off: The converter is in operation, a start signal is applied, and the output is active. This also includes ramping, running on reference, and AMA. <p>Note: When a fault has occurred in the converter, the LED is on though the start command is available. If there is a fault event, and the start command is disabled and reinitiated again, the Off LED blinks.</p>
9	Stop button	Stops the operation of the converter.
10	Info button	Provides more detailed information about an event that has occurred in the converter. Pressing Info also shows a context sensitive help for parameters.
11	Arrow buttons and OK button	<ul style="list-style-type: none"> • Arrow buttons: Used to navigate within the different screens and menus. • [OK]: Primarily used to confirm selections and data in the control panel display.
12	Home/Menu button	Toggles between Home screen and the current parameter menu, to allow quick access to key status information during parameter setup.

3.2.3 Control Panel Basic Configurations

The basic configurations of the control panel include:

- A readout of the status of the motor and the drive, including warnings and faults.

- Navigable menus, where the parameter settings of the drive can be viewed and changed.

3.2.4 Starting the Drive and Control Panel Display

While the drive is powering up until it is ready to operate, the display of the control panel shows the iC7 logo.

NOTICE

When the drive is started, it takes 25–30 s for the drive to be in ready state and for the control panel display to change to the Status screen (default).

3.2.5 Understanding Status Screens

When the drive is in ready state, the control panel display shows the *Status* screen. The *Status* screen can be customized.

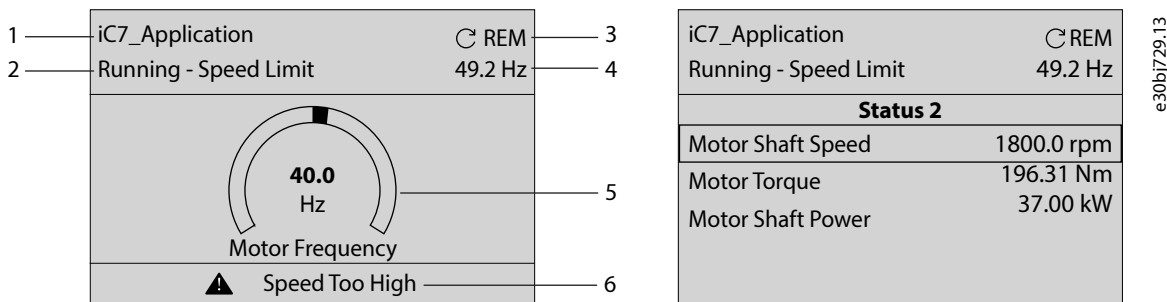

Figure 5: Status Screen (Donut View vs. Line View)

<p>1 The name of the application software.</p> <p>3 The current control of the drive. REM indicates remote control and LOC indicates local control. The arrow shows the direction of the motor.</p> <p>5 The status signal value as a donut infographic view. It is possible to show only a single signal in a donut view. When more than 1 signal is configured, the screen changes to a line view. A minimum of 2 and a maximum of 5 signals are shown in the line view.</p>	<p>2 The status of the drive (see the following table).</p> <p>4 Shows the value selected with parameter 8.3.2.2 Status Line Right.</p> <p>6 The most recent active warning pops up in the bottom of the screen when it occurs. If the warning is persistent, it must be reset in the <i>Events</i> screen.</p>
--	--

To navigate between *Status Screen 1* and *Status Screen 2*, press the left and right arrows on the control panel.

The status line of the control panel shows the status of the drive. The status line texts are dynamically generated, based on the configuration of the system. The following are some examples of basic operation:

Table 8: Drive Status Texts

Drive status in the panel	Description
Drive Ready	The drive is powered and ready to start.
Running at Reference	The drive is running at the selected reference.
Running at Standstill	The drive is running with 0 reference.
Stopping	The drive is running towards stop.
Stopped	The drive is stopped due to an active stop command.
Coasted	The drive is coasting due to an active coast command.
Quick Stop	The drive is stopped due to an active quick stop command.

Table 8: Drive Status Texts (continued)

Drive status in the panel	Description
Start Interlock	The drive is stopped while a start command is active. To restart after the block is removed, the start command must be removed and given again.
Start Blocked	The drive is in a state that is preventing start. All start commands are ignored.
Disabled Reference	The drive setpoint has been disabled with the PROFIdrive Control Word (see 2.12.2 Control Word).
Reversing	The drive is reversing due to an active reverse command.
Reversing at Reference	The drive is reversing at the selected reference.
Motor Disconnected	The drive has detected a disconnected motor (see parameter 4.5.3 Disconnected Motor Response in 6.5.5 Protection (Menu Index 4.5)).
Fault ! Start Blocked	The drive has an active fault that is preventing start.
Fault ! Stopping	The drive has detected a fault and is running towards stop.
Fault ! Derating	The drive is derating its output to thermally protect the Advanced Harmonic Filter (see parameter 3.4.3 Thermal Switch Response in 6.4.5 Advanced Harmonic Filter (Menu Index 3.4)).
Safe Torque Off (STO)	The drive is coasting due to an active STO command.
Safe Stop (SS1/SS2)	The drive is stopping on a safe stop command.
Inching	The drive is inching or jogging.
Inching at Standstill	The drive is inching with 0 reference.
Inching at Reference	The drive is inching with the selected inching reference.
Running Frozen Reference	The drive is running at frozen reference due to an active frozen reference command.
Stopping Frozen Reference	The drive is running towards stop due to an active stop command with a frozen reference command.
Running/Stopping/Inching with: <ul style="list-style-type: none"> • Power Limit • Undervoltage Limit • Overvoltage Limit • Torque Limit • Current Limit • Speed Limit 	The drive is running, stopping, or inching, and has exceeded the limit that is shown. For example, <i>Running - Power Limit</i> . Some possible limits are listed in the cell on the left.
AMA Ready	Advanced Motor Adaptation is activated and is waiting for the start command.
AMA in Progress	Advanced Motor Adaptation is running, measuring motor data.
AMA Finished	Advanced Motor Adaptation is finished. To restart the drive, remove and then reapply the start command.
Inertia Est. Ready	Inertia Estimation is activated and is waiting for the start command.
Inertia Est. in Progress	Inertia Estimation is running, measuring system inertia.
Inertia Est. Finished	Inertia Estimation is finished. To restart the drive, remove and then reapply the start command.
Motor Feedback Test Ready	Motor Feedback Test is activated and is waiting for the start command.
Motor Feedback Test Running	Motor Feedback Test is running, checking feedback settings.
Auto Tuning in Progress	The Autotuning of the Process Controller is running, measuring the plant characteristics.

3.2.6 Adjusting Display Backlight and Contrast

When in *Status Screen 1* or *Status Screen 2*, it is possible to adjust the backlight intensity and contrast of the display.

To adjust the display backlight and contrast settings, press the [Info] button and any of the arrow buttons of the control panel. The settings are shown on the screen:

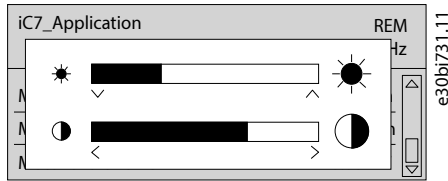

Figure 6: Intensity Change in Backlight and Contrast

- To change the intensity of the backlight, keep pressing the [Info] button along with either the up or down arrow buttons of the control panel.
- To change the contrast, keep pressing the [Info] button along with either the left or right arrow buttons of the control panel.

3.2.7 Changing the Content of the Status Screens

The content of the status screens can be changed with parameters in the parameter groups **8.3.3 Status Screen 1** and **8.3.4 Status Screen 2**. Up to five status signals can be selected for each screen. By default, *Status Screen 1* shows the actual value of the selected control mode, for example speed or torque, and *Status Screen 2* shows three signals:

- Motor shaft speed
- Motor torque
- Motor shaft power

If the screen shows only one signal, it is shown as a donut graph. If the screen shows more than one signal, they are shown as a line view.

3.2.8 Main Menu and Overall Navigation

Pressing the [Home/Menu] button toggles between the status screens and the main menu screen.

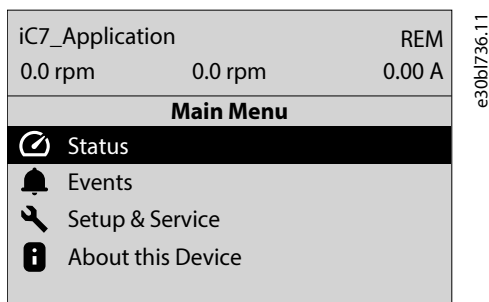

Figure 7: Main Menu Screen

Basic navigation techniques

To navigate through and within the main menu, use the navigation buttons of the control panel.

- To navigate to different entries of the menu, press the up or down arrows of the control panel.
- To navigate to a lower level in the menu press the *OK* button, and to navigate to a higher level press the *Back* button.

Contents of the menu

The main menu has 4 selections

Table 9: Main Menu Contents

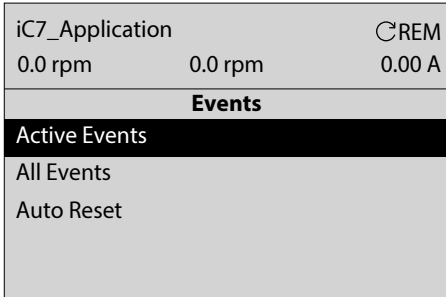
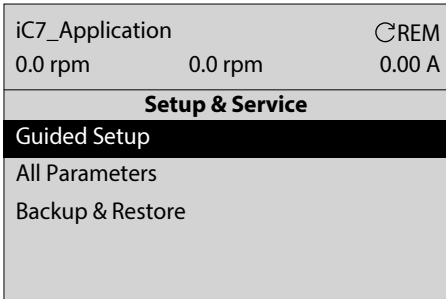
Selection	Function								
Status	Returns to <i>Status Screen 1</i>								
Events	<p>Access event-related content.</p>  <p>Figure 8: Events Screen</p> <table border="1"> <tr> <td>Active Events</td> <td>View active events and reset them.</td> </tr> <tr> <td>Event History</td> <td>View the history of events.</td> </tr> <tr> <td>Event Simulation</td> <td>Simulate an event (see 6.7.4.1 Event Simulation (Menu Index 6.4.3)).</td> </tr> <tr> <td>Auto Reset</td> <td>Configure the automatic reset behavior (see 6.7.4.2 Auto Reset (Menu Index 6.4.4)).</td> </tr> </table>	Active Events	View active events and reset them.	Event History	View the history of events.	Event Simulation	Simulate an event (see 6.7.4.1 Event Simulation (Menu Index 6.4.3)).	Auto Reset	Configure the automatic reset behavior (see 6.7.4.2 Auto Reset (Menu Index 6.4.4)).
Active Events	View active events and reset them.								
Event History	View the history of events.								
Event Simulation	Simulate an event (see 6.7.4.1 Event Simulation (Menu Index 6.4.3)).								
Auto Reset	Configure the automatic reset behavior (see 6.7.4.2 Auto Reset (Menu Index 6.4.4)).								
Setup & Service	<p>Access parameters, backup and restore, and the motor setup wizard.</p> <p>Setup and Service Screen</p>  <table border="1"> <tr> <td>All Parameters</td> <td>Access all the parameters of the drive.</td> </tr> <tr> <td>Backup & Restore</td> <td>Back up the system or restore a previous backup (see 3.2.13.1 Making a System Backup Using the Control Panel and 3.2.13.2 Restoring the System Configuration Using the Control Panel).</td> </tr> <tr> <td>Guided Setup</td> <td>Perform a guided setup of the motor.</td> </tr> </table>	All Parameters	Access all the parameters of the drive.	Backup & Restore	Back up the system or restore a previous backup (see 3.2.13.1 Making a System Backup Using the Control Panel and 3.2.13.2 Restoring the System Configuration Using the Control Panel).	Guided Setup	Perform a guided setup of the motor.		
All Parameters	Access all the parameters of the drive.								
Backup & Restore	Back up the system or restore a previous backup (see 3.2.13.1 Making a System Backup Using the Control Panel and 3.2.13.2 Restoring the System Configuration Using the Control Panel).								
Guided Setup	Perform a guided setup of the motor.								
About this Device	View the device information, including the control panel software version.								

3.2.9 Changing the Selections of a Parameter

When a parameter has selections, the parameter index and name are highlighted in black. The example parameter in this procedure is *P 5.8.6.2.1 Ramp 1 Type*.

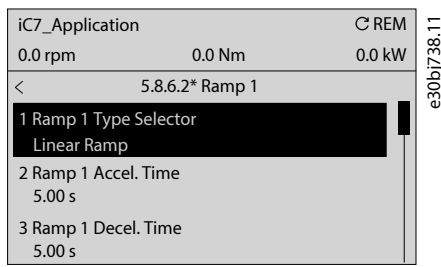

Figure 9: A Parameter with Selections

1. Press the [Home/Menu] button to enter the main menu.
2. Navigate to *Setup & Service* and press [OK].
3. Navigate to *All Parameters* and press [OK].
4. To view the selections of a parameter, navigate to the parameter in the parameter structure and press [OK] on the control panel. The selections available for the parameter are shown on the screen.

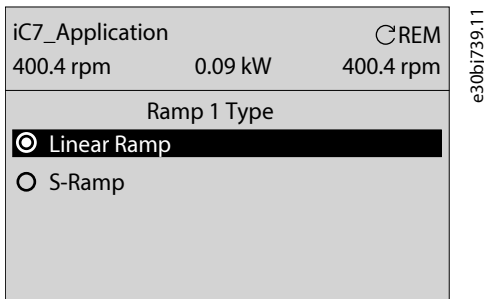

Figure 10: The Selections of a Parameter

5. To browse through the selections, press the up or down arrow buttons.
6. To select a selection, press [OK].

3.2.10 Changing a Parameter Value

The example parameter in this procedure is *P 5.8.6.2.2 Ramp 1 Accel. Time*.

1. Press the [Home/Menu] button to enter the main menu.
2. Navigate to *Setup & Service* and press [OK].
3. Navigate to *All Parameters* and press [OK].
4. Navigate to parameter *5.8.6.2.2 Ramp 1 Accel. Time* and press [OK].

The range of the parameter (minimum to maximum values) is shown at the bottom of the control panel display.

5. To go to the values before or after the decimals, use the left and right arrow buttons. A black highlight on the digit indicates the location where the cursor is active.
6. To increase or decrease the value, press the up and down arrow buttons.
7. Confirm the changes by pressing [OK].

The following illustration shows the process of changing the value of the parameter.

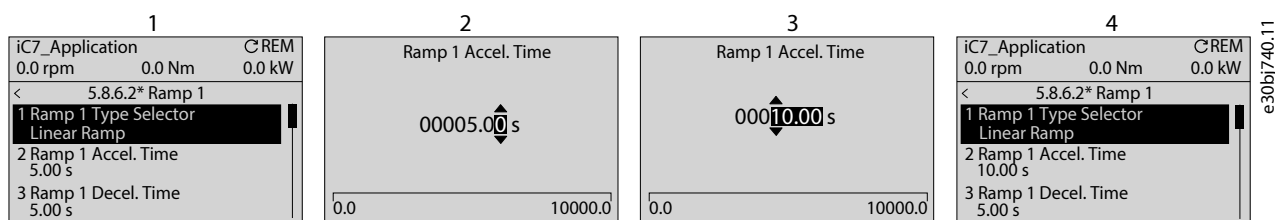

Figure 11: Changing the Value of a Parameter

3.2.11 Locking the Control Panel Display

To avoid unintended interaction via the control panel, the control panel display can be locked.

To lock the control panel, press the [Back] button for 3 s. After 3 s, the following screen is shown.

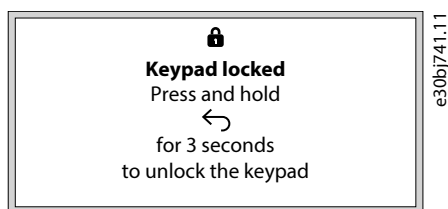

Figure 12: Control Panel Lock Screen

When the control panel is locked, pressing the control panel buttons has no effect.

To unlock the control panel, press the [Back] button for 3 s.

3.2.12 Control Panel Shortcuts

The following table lists shortcuts in navigating in the control panel.

Table 10: Control Panel Shortcuts

Action	Precondition	Buttons	Activation time
Fast scroll	When in a menu or list of choices	Up and down arrows	1 s to activate
Factory reset		<i>Home</i> + <i>Back</i> + down arrow	3 s to activate
Keypad lock		Back	3 s to activate or deactivate
Reference set point editing	<ul style="list-style-type: none"> <i>Home</i> screen is active LOC mode is active Control is allowed 	[OK]	Single press
Adjusting screen contrast and brightness	<i>Home</i> screen is active	<i>Info</i> + arrows	Continuous simultaneous press

3.2.13 Backup and Restore

3.2.13.1 Making a System Backup Using the Control Panel

Back up the current system configuration using the control panel

1. Press the [Home/Menu] button to enter the main menu.
2. Navigate to *Backup & Restore*.
 - Select *Setup & Service* > *Backup & Restore*.
 - Select *Setup & Service* > *All Parameters* > *Backup & Restore* (Menu Index 6.7).

3. Select *Backup*.

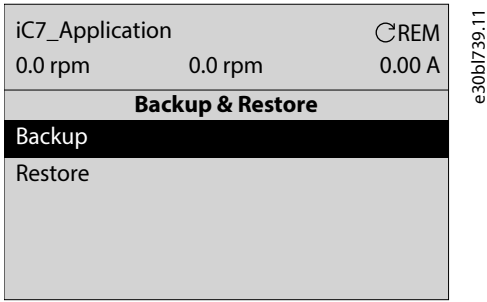

Figure 13: Backup and Restore Menu

The backup wizard starts.



Figure 14: Start Backup

- 4. Press [Right arrow] to start the backup process.
- 5. Select the storage place for the backup file.

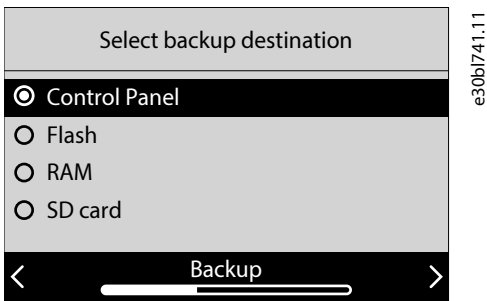

Figure 15: Select Backup Destination

NOTE: The selections depend on the hardware configuration.

- 6. Press [Right arrow] and wait until the operation is completed.



Figure 16: Backup Completed

7. To exit press [OK].

3.2.13.2 Restoring the System Configuration Using the Control Panel

Restore the system configuration from a backup file or to default factory settings using the control panel

1. Press the [Home/Menu] button to enter the main menu.
2. Navigate to *Backup & Restore*.
 - Select *Setup & Service > Backup & Restore*.
 - Select *Setup & Service > All Parameters > Backup & Restore (Menu Index 6.7)*.
3. Select *Restore*.

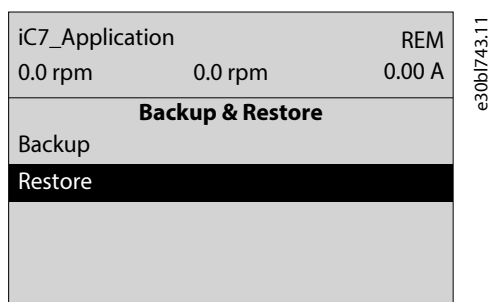

Figure 17: Backup and Restore Menu

The backup wizard starts.



Figure 18: Start Restore

4. Press [Right arrow] to start the restore process.
5. Choose whether to restore the system configuration from a backup file or to return the system to default factory settings.



Figure 19: Select Restore Type

- Select *Restore from backup*, and select the file to restore.
 - Select *Restore factory settings*
6. Press [OK] to acknowledge that the current settings will be overridden, and wait until the operation is completed.

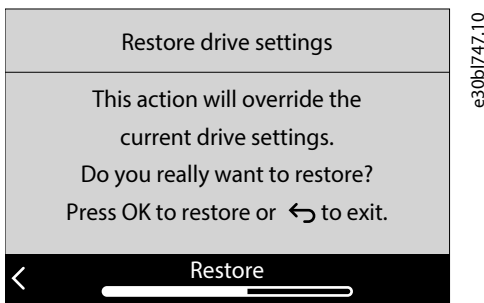

Figure 20: Confirm the Restore Operation

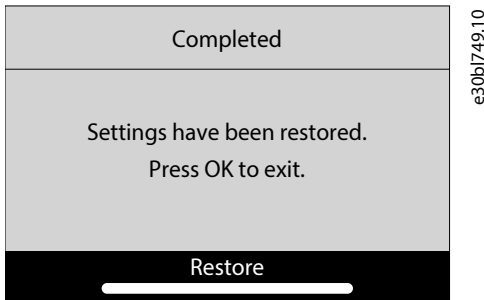

Figure 21: Backup Completed

7. To exit press [OK].

3.3 MyDrive® Insight

3.3.1 Introduction to MyDrive® Insight

MyDrive® Insight is a platform-independent software tool that supports the commissioning, engineering, and monitoring of the iC7 series. Some of the key features include:

- Fast and easy configuration and commissioning
- Monitoring the drives as part of daily operations
- Collecting data and information for troubleshooting, maintenance, and service
- Discovering and accessing multiple drives in a network
- Intuitive user interface with notifications and visualizations on real time converter information and events
- PC control to perform operations such as starting or stopping the drive, set references, set direction, reset, and coast of the drive
- Performing updates on single or multiple drives
- Backing up and restoring parameter settings
- Data logging and analyzing for troubleshooting

NOTE: The section is documented for MyDrive® Insight version 2.14.0 or above. To utilize the latest MyDrive® Insight functions, make sure to uninstall lower versions of MyDrive® Insight from the workstation.

NOTE: The section MyDrive® Insight in the application guide covers basic information such as getting started with MyDrive® Insight, accessing and viewing or changing the parameters, and PC control to operate the drive using MyDrive® Insight. For further information on the different MyDrive screens, integrated help within MyDrive® Insight will be available in future releases.

3.3.2 Getting Started with MyDrive® Insight

As a prerequisite, ensure that MyDrive® Insight is installed on the device (PC or laptop). MyDrive® Insight can be downloaded and installed from MyDrive® Suite, available here: <https://suite.mydrive.danfoss.com/>

1. To establish a point-to-point connection between the drive and the device, use the communication interface X0 and the RJ45 Ethernet port on the device by using a standard Ethernet cable.

If the device does not have an RJ45 Ethernet port or it is already in use, then a conventional adapter from USB-C to RJ45 can be used. To connect several drives at the same time, use an Ethernet switch between the PC and the control unit.

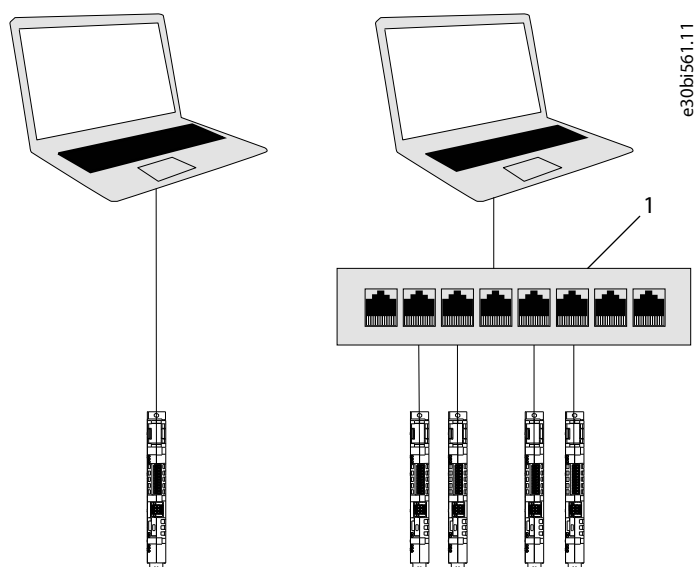

Figure 22: Connection to the PC

1 Ethernet switch

2. When the drive is powered up and in *Ready* state, open MyDrive® Insight on the device and the drive is recognized.
3. To establish or confirm the connection, click the arrow button.

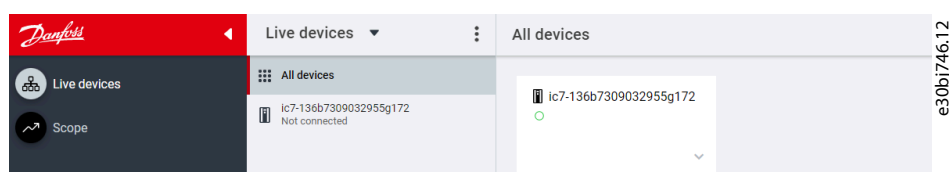

Figure 23: Confirm Connection

Once the connection is established, the drive is marked with a green connection symbol in MyDrive® Insight.

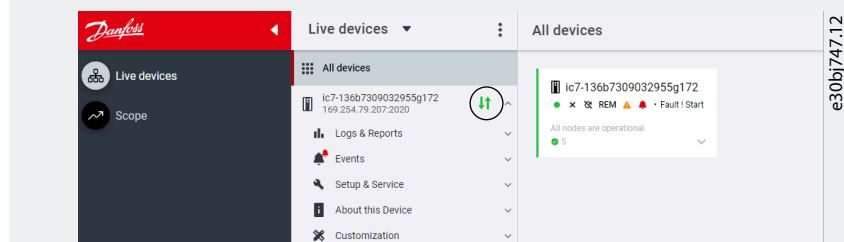

Figure 24: Connection Established

- To interact with the drive, navigate to the required screen in MyDrive® Insight. The example picture shows the *Device Info* screen.

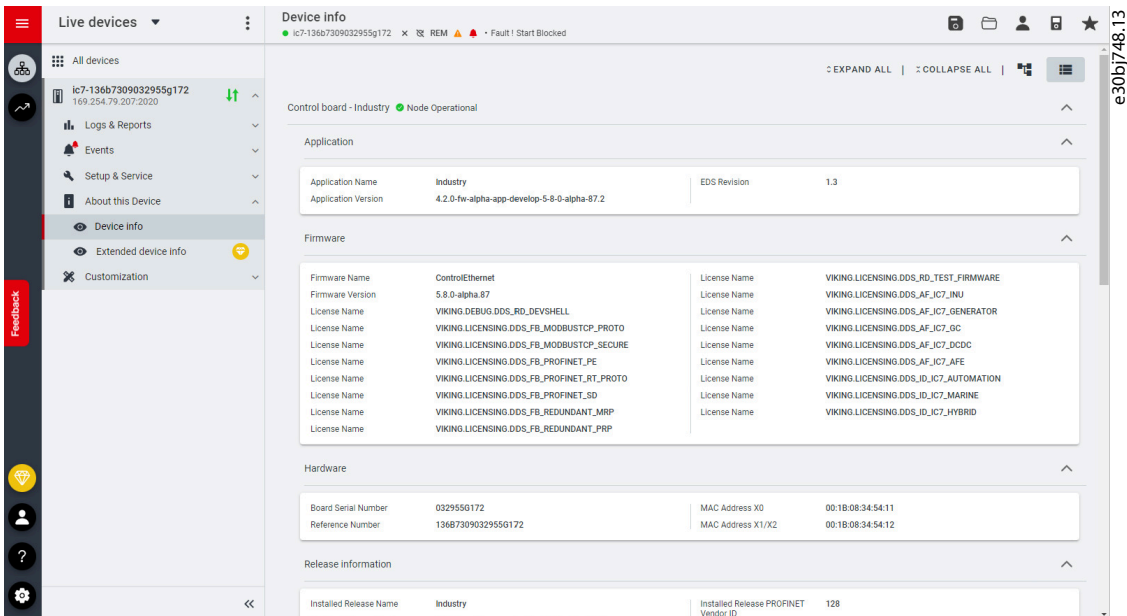

Figure 25: Device Info

NOTE: The application guide covers basic information such as accessing parameters and using MyDrive® Insight as the PC control place.

3.3.3 Accessing Parameters and Understanding Parameter Screens in MyDrive® Insight

- To access the parameters of the connected drive, click *Setup and Service*.
- Click *Parameters > Live*.

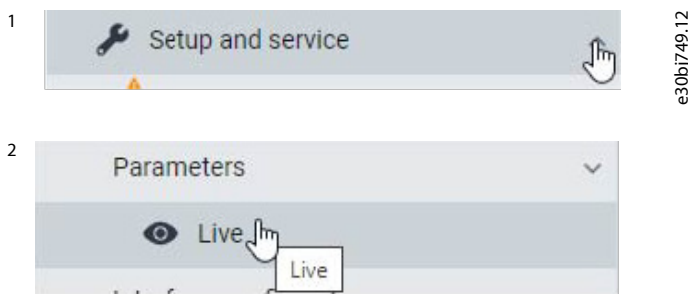

Figure 26: Setup and Service

➡ The Parameters (Live) screen opens.

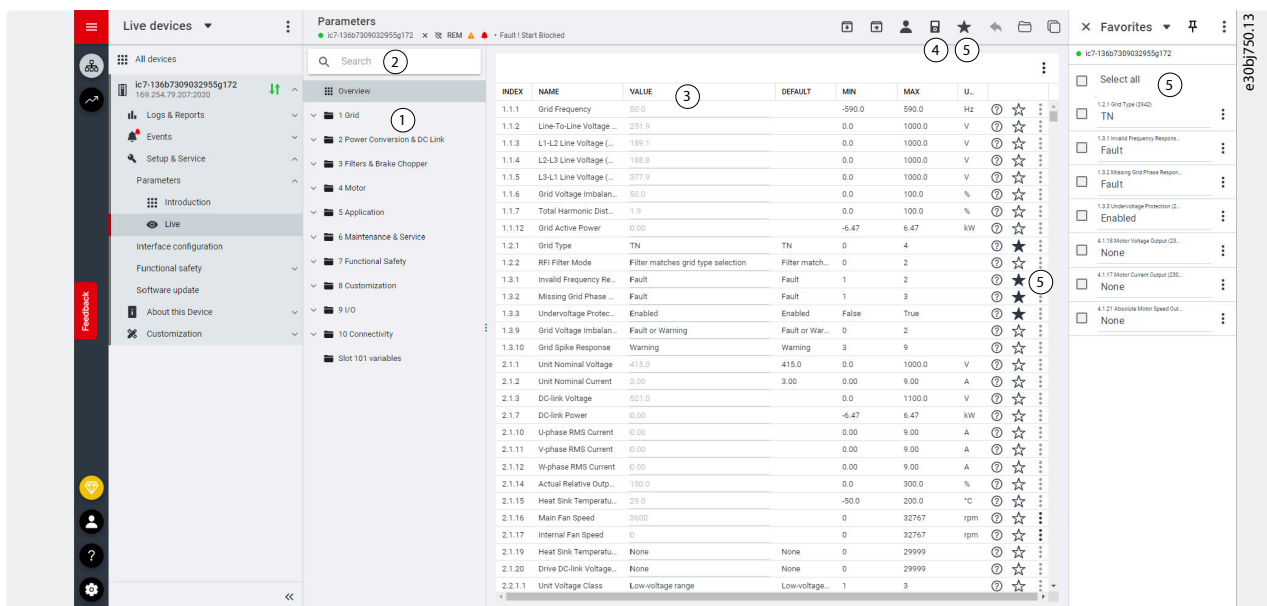

Figure 27: Parameters (Live)

- | | |
|--|--|
| <p>1 Parameter group: Navigate through the different parameter groups in the drive.</p> <p>3 Value field: View and change a parameter value or selection. All the parameters for the drive are shown on the Live screen.</p> <p>5 Favorites: Select a parameter as a favorite by clicking the star in its row. Open the favorites panel on the right side of the screen by clicking the star at the top of the page.</p> | <p>2 Search field: Use the search function to find a specific parameter.</p> <p>4 PC Control button: Switch to PC control to start or stop the drive using MyDrive® Insight.</p> |
|--|--|

3. Navigate through the parameter groups.
 - a. Click the parameter group (1) from the Live pane.
 - b. Click the parameter subgroup (2).
 - c. Repeat step 2 until the right level of parameter sub group (3) is reached to find the specific parameters (4).

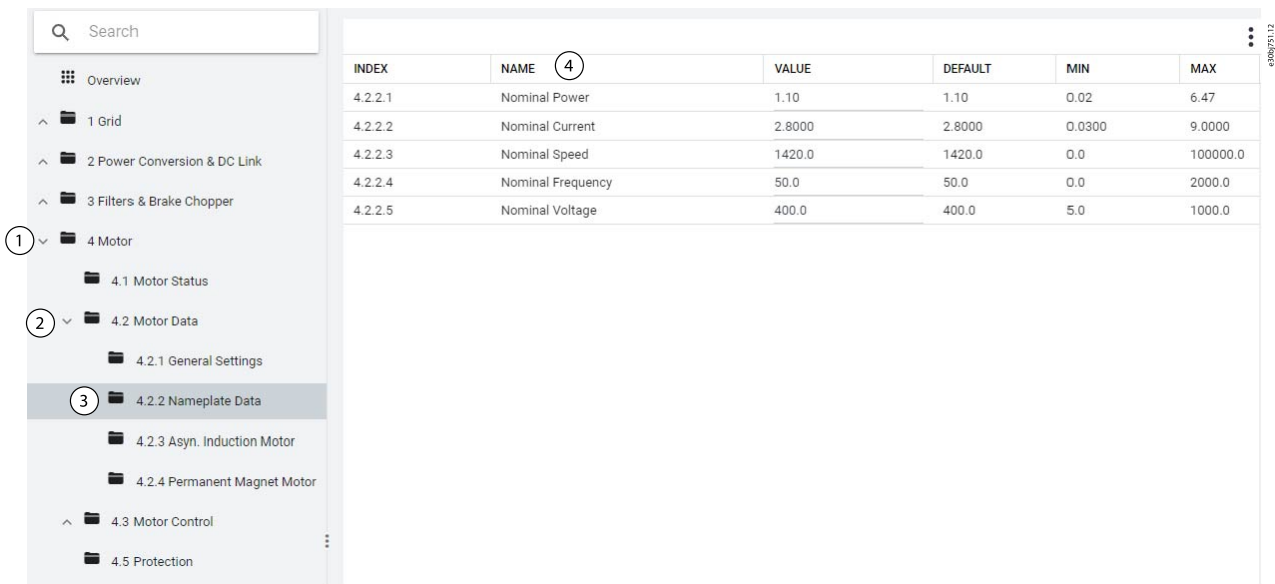

Figure 28: Navigating the Parameter Groups

NOTE: When in a specific parameter subgroup, only parameters in that parameter subgroup can be accessed.

Searching for a specific parameter

Type the search term in the *Search* field. The search returns all parameters that have the search term in the name.

In the following example, all parameters with *DC-Link* in the name are listed in the search results.

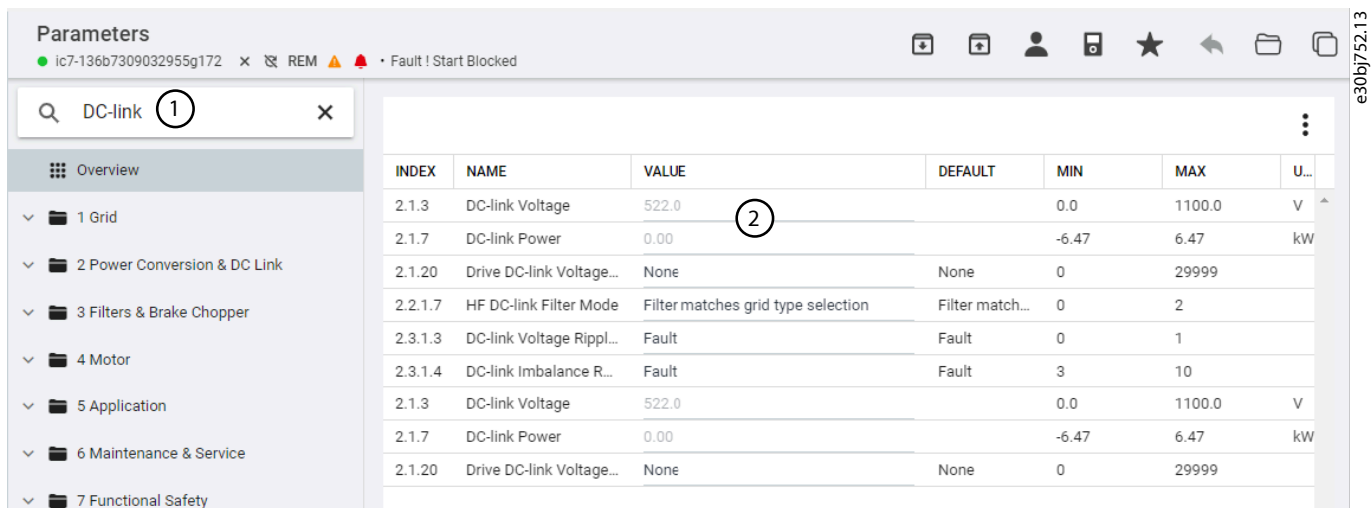

Figure 29: Search Function



3.3.4 Viewing and Changing Parameter Settings

When in a specific parameter group, all parameters related to the parameter group are shown. Depending on the access type of the parameter, there is a possibility to view the parameter setting or change the current selection or value of the parameter.

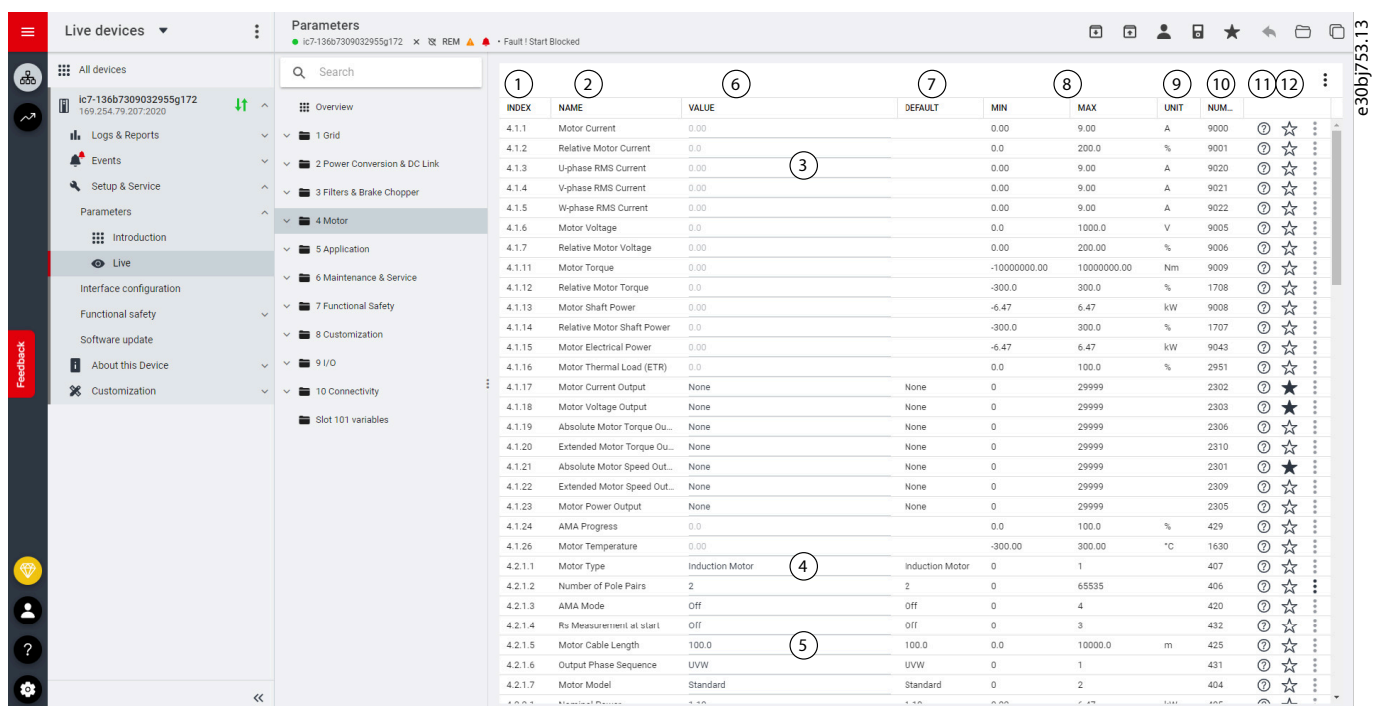

Figure 30: Parameter Overview

Table 11: Legend Table

Legend	Description	Further information
1	<i>Index</i>	Based on the parameter group structure, the index defines the location of the parameter. The index is not used as a unique identifier of a parameter.
2	<i>Name</i>	Name of the parameter.
3	Status parameters	The current status or value of a parameter. The parameter value is shown in a light gray color and cannot be changed.
4	Selection parameters	To see all selections available for the parameter, click the value in the <i>Value</i> field.
5	Range parameters	The parameter value can be modified based on the defined range (maximum and minimum values).
6	<i>Value</i>	The current value of the parameter.
7	<i>Default</i>	The factory setting (default value) of the parameter.
8	<i>Min and Max</i>	When applicable, the minimum and maximum values of the parameter are shown in the <i>Min</i> and <i>Max</i> .
9	<i>Unit</i>	When applicable, the unit of the parameter is shown in the <i>Unit</i> field.
10	<i>Number</i>	The unique identifier for each parameter. The identifier is independent and decoupled from the parameter index values.

Table 11: Legend Table (continued)

Legend	Description	Further information
11	Help	Click the ? button to see a description about the parameter. For more detailed descriptions, see chapter 6 Parameter Descriptions.
12	Favorites (star)	Clicking the Favorites icon adds the parameter to Favorites.

3.3.5 PC Control: Operating the Drive Using MyDrive® Insight

To operate the drive using PC control, click the *Control Panel* button in MyDrive® Insight. The following illustration shows the required steps to operate the drive via MyDrive® Insight.

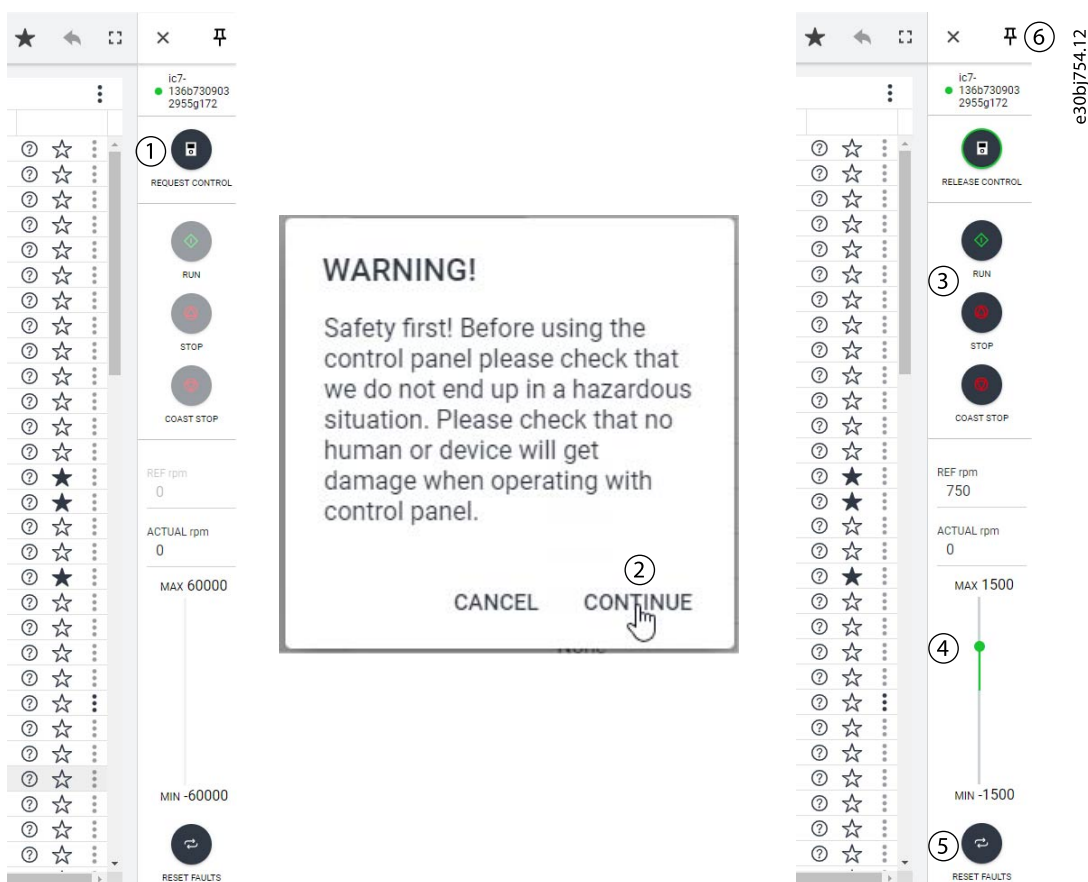

Figure 31: Operate the Drive Using MyDrive® Insight

1. Click the *REQUEST CONTROL* button (1).
2. To confirm secure operational conditions while controlling the drive using MyDrive® Insight, click *Continue* (2).
3. Use the *START*, *STOP*, and *COAST STOP* buttons (3) to perform drive operations. Use the sliders (4) to increase or decrease the reference speed.
4. To reset the drive in case of a fault, click *RESET FAULTS* (5).
5. For ease of access, click the Pin button (6) to make the control panel be constantly visible on the screen.

3.3.6 Datalogger

3.3.6.1 Introduction to Datalogger

The Datalogger in MyDrive Insight enables the monitoring of signals and related information for the selected signals.

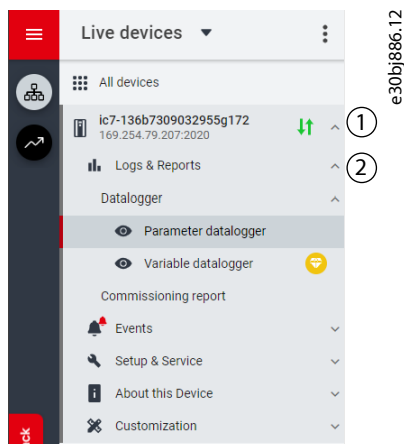

Figure 32: Navigating to Datalogger

To access the Datalogger feature, select the drive (1), then go to *Logs & Reports > Datalogger > Parameter datalogger* (2).

The following image shows the Datalogger main controls:

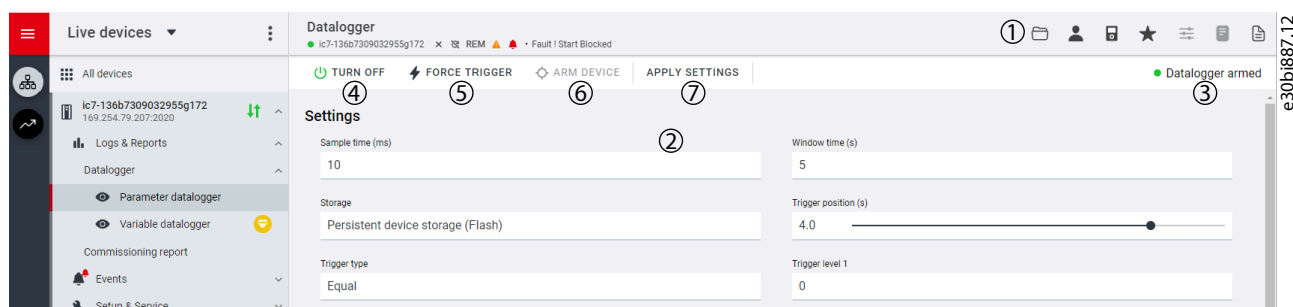

Figure 33: Datalogger Screen

- | | |
|--|--|
| <p>1 Open the window to select available Datalogger files for viewing.</p> | <p>2 The list of Datalogger settings.</p> |
| <p>3 Datalogger status.</p> | <p>4 Enable or disable Datalogger. When disabled, all Datalogger configuration settings are inactive. When enabled, Datalogger is active and operates based on the configuration settings.</p> |
| <p>5 Activate the force trigger. The 0–1 transition (rising edge) triggers Datalogger manually. This function is typically used with automatic triggers.</p> | <p>6 Arm Datalogger. The 0–1 transition (rising edge) readies Datalogger for triggering.</p> |
| <p>7 Apply any changed settings.</p> | |

3.3.6.2 Configuring Datalogger

There are 2 main steps to configuring Datalogger:

- Configure the signals to be recorded using Datalogger.
- Configure the Datalogger settings.

1. Open Datalogger

The *Settings* view opens.

- Enter the required and desired settings.

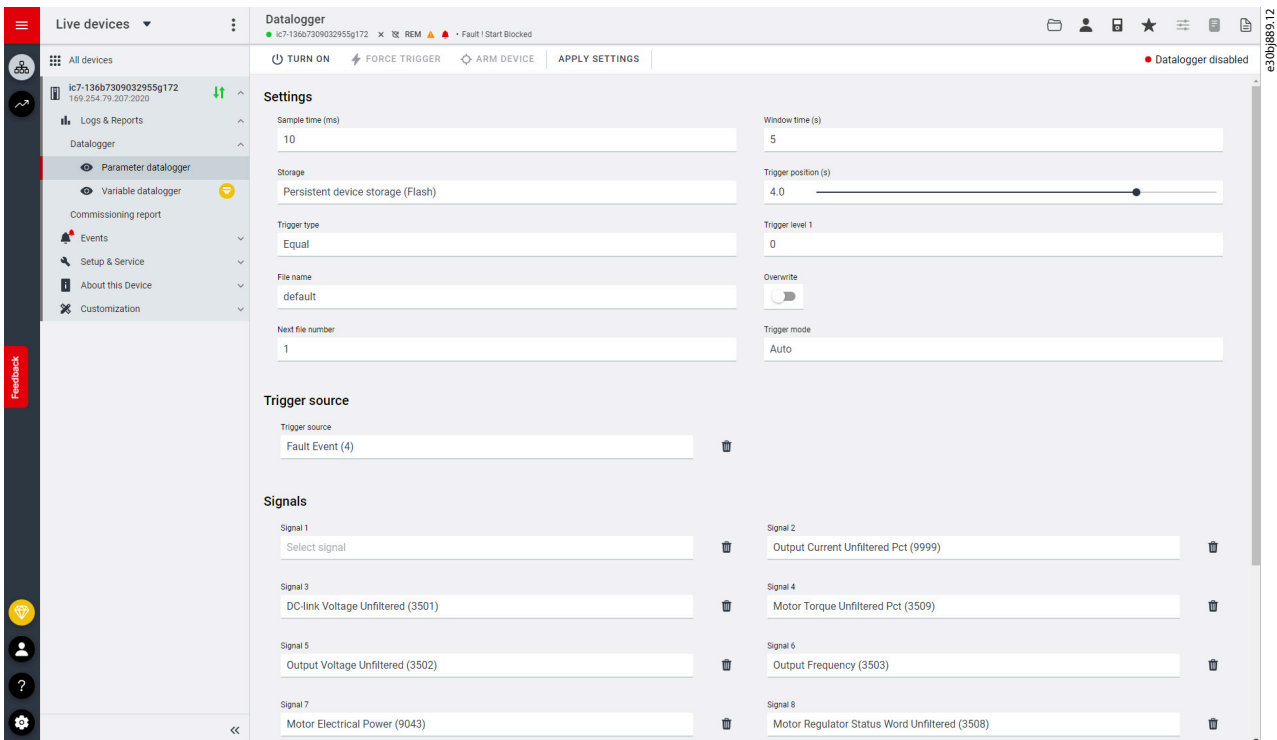

Figure 34: Datalogger Settings

The following table describes the user interface elements:

Table 12: Datalogger Settings Fields

Field name	Field description
Sample time (ms)	Enter a sample time in ms. The actual sample time depends on the switching frequency. Fast sample rate settings result in data changing slowly in the resulting log.
Window time (s)	Define the size of the capture window. Enter the window time in seconds. High sample rates and large capture times that result in large capture files may be rejected when the configuration is applied.
Storage	Select the location to which datalogger files are stored. Available selections are: <ul style="list-style-type: none"> RAM: Settings are stored to the RAM of the drive. Flash: Settings are stored to the flash of the drive. SD card: Data is stored on the (optional) microSD card. The microSD cards supported are: SD, SDHC, or SDXC which must be formatted for the FAT32 file system. SDHC is the recommended type, because they are delivered preformatted to FAT32.

Table 12: Datalogger Settings Fields (continued)

Field name	Field description
Trigger position (s)	Adjust the slider to position the trigger. Setting the trigger position to 0 indicates the datalogger recording starts at the time of the trigger. Setting a negative value indicates that the datalogger recording starts after the trigger has occurred. Setting a positive value indicates that the datalogger recording starts before the trigger has occurred.
Trigger type	Following are the trigger types: <ul style="list-style-type: none"> • No trigger (manual trigger only). • Equal triggers when the value of the trigger source variable is equal to trigger level 1. • Not equal triggers when the value of the trigger source variable is not equal to trigger level 1. • Greater than triggers when the value of the trigger source variable is greater than trigger level 1. • Greater than or equal to triggers when the value of the trigger source variable is greater than or equal to trigger level 1. • Less than triggers when the value of the trigger source variable is less than trigger level 1. • Less than or equal to triggers when the value of the trigger source variable is less than or equal to trigger level 1. • Rising edge triggers when the value of the trigger source variable rises above trigger level 1. If the trigger source is already above trigger level 1, the trigger must first drop below the trigger level. • Falling edge triggers when the value of the trigger source variable falls below trigger level 1. If the trigger source is already below trigger level 1, the trigger must first rise above the trigger level.
Trigger level 1	Defines the trigger level associated with the defined trigger type. This level is used for all single-level trigger types. The entry in the field defines the lower trigger level for window trigger types, such as bounds and out of bounds.
File name	Name of the file for datalogger recording.
Overwrite	To turn the overwrite function on or off, click the <i>Overwrite</i> -toggle button. <ul style="list-style-type: none"> • On: Overwrite is enabled. A file number is not appended to the data log file. Instead, the datalogger overwrites a previous datalog file. • Off: Overwrite is disabled. A file number is appended to the log file. For each datalog, the datalog file is incremented and the previous datalog file is not overwritten.

Table 12: Datalogger Settings Fields (continued)

Field name	Field description
Next file number	The number entered in this field is appended to the initial datalog file. Entry in the field is useful when datalogs are previously available in the drive. The number is auto-incremented with each datalog recording when the entry in <i>Next file number</i> is enabled.
Trigger mode	Select 1 of the following trigger modes: <ul style="list-style-type: none">• Single: After a datalog recording, the datalogger must be rearmed before another trigger is allowed.• Auto: After a datalog recording, the datalogger automatically rearms and starts to accept triggers.

Table 12: Datalogger Settings Fields (continued)

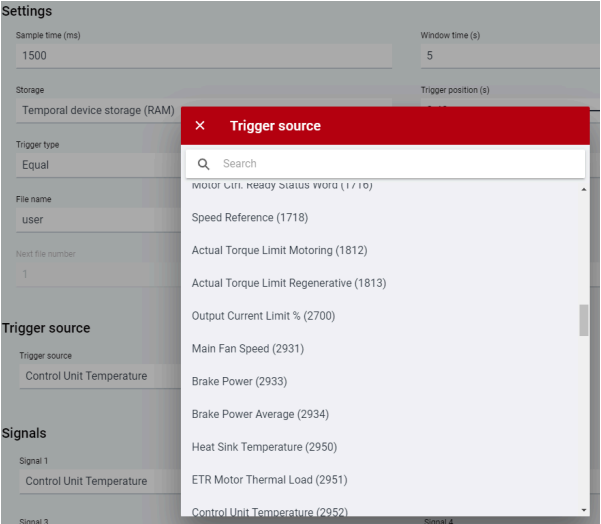
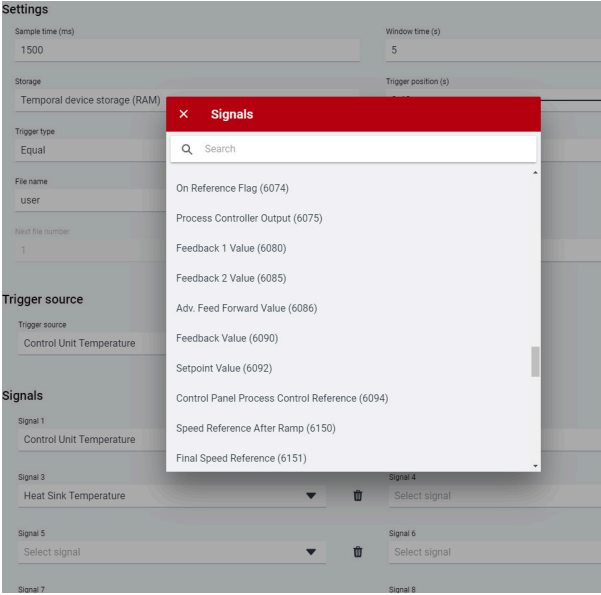
Field name	Field description
Trigger source	<p>Click the <i>Trigger source</i> field to select the signal source which is used for triggering the datalogger recording. The trigger source list opens in a new window:</p>  <p>Figure 35: Trigger Source List</p>
Signals	<p>Click the <i>Add signal</i> button under the <i>Signals</i> heading. A <i>Signal</i> field appears. Click the <i>Signal</i> field to select the signals that are logged. The signal list opens in a new window:</p>  <p>Figure 36: Signals List</p>

3. Click *Apply Settings*.

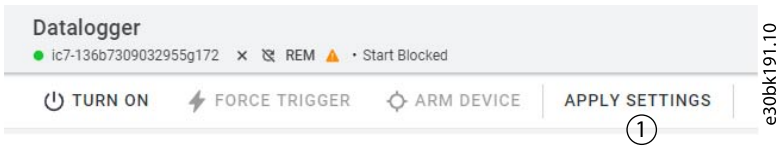

Figure 37: Apply settings

After the signal selection and the datalogger settings, the datalogger is ready to record the logs. To view a recorded datalog file, click the icon shown in the following figure.

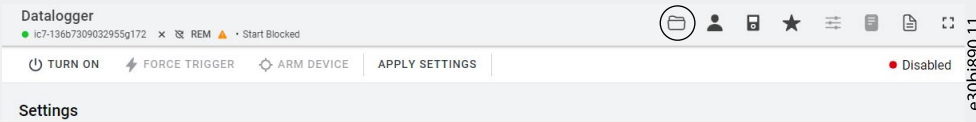

Figure 38: Datalogger View Icon

3.3.7 Backup and Restore

3.3.7.1 MyDrive® Insight Backup

The Backup feature in MyDrive® Insight allows storing the parameter settings of the drive into a new or existing project file, RAM, or Flash memory of the drive, or to an optional microSD card.

To use the microSD card as a storage device, the microSD card must be inserted in the slot on the interface module located behind the control panel, as shown in the following illustration.

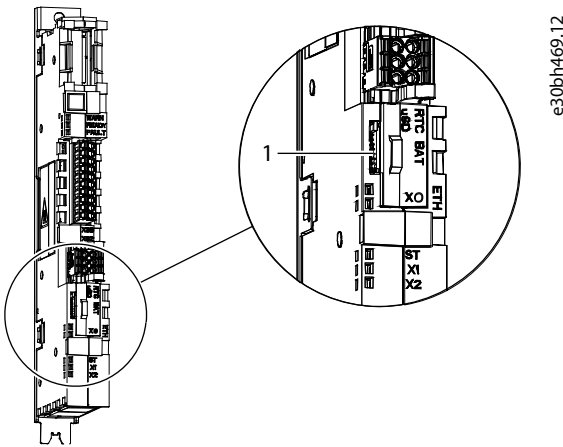

Figure 39: MicroSD Card Slot

- 1 The microSD card slot

The following are the types of microSD card supported by the interface module. The card must be formatted for the file system FAT32.

- Secure Digital (SD) card
- Secure Digital High Capacity (SDHC)
- Secure Digital Extended Capacity (SDXC)

NOTE: It is recommended to use SDHC cards as they are delivered preformatted to FAT32.

3.3.7.2 Backing up the Drive

1. To back up the drive, select a drive, go to *Setup & Service > Parameters*.
2. Click the backup destination icon shown in the following figure.

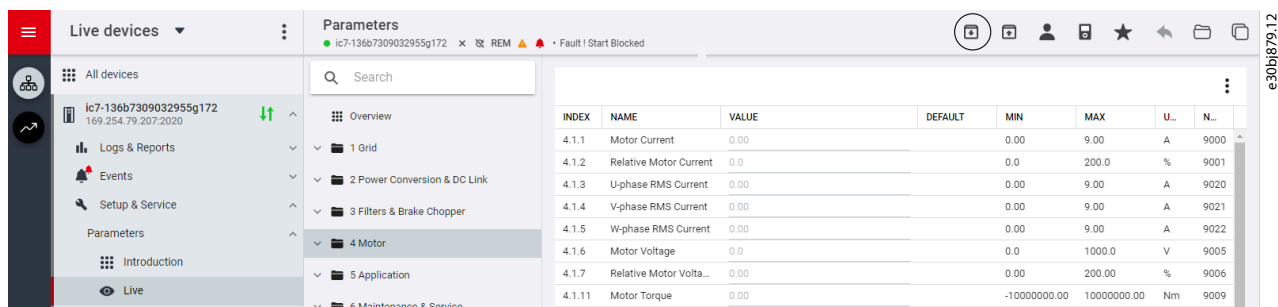

The screenshot shows the 'Parameters' section of the iC7 Series Industry user interface. The interface includes a sidebar with navigation options like 'All devices', 'Logs & Reports', 'Events', 'Setup & Service', 'Parameters', 'Introduction', and 'Live'. The main area displays a table of parameters with columns for INDEX, NAME, VALUE, DEFAULT, MIN, MAX, U., and N.. A red circle highlights a backup destination icon in the top right corner of the Parameters table.

INDEX	NAME	VALUE	DEFAULT	MIN	MAX	U.	N.
4.1.1	Motor Current	0.00		0.00	9.00	A	9000
4.1.2	Relative Motor Current	0.0		0.0	200.0	%	9001
4.1.3	U-phase RMS Current	0.00		0.00	9.00	A	9020
4.1.4	V-phase RMS Current	0.00		0.00	9.00	A	9021
4.1.5	W-phase RMS Current	0.00		0.00	9.00	A	9022
4.1.6	Motor Voltage	0.0		0.0	1000.0	V	9005
4.1.7	Relative Motor Volta...	0.00		0.00	200.00	%	9006
4.1.11	Motor Torque	0.00		-10000000.00	10000000.00	Nm	9009

Figure 40: Backup Destination icon



A screen to select the backup destination opens. The destinations to back up are:

- **Project:** The user can back up an existing project or a new project.
- **Device file system:** The user can back up to 1 of the available memory devices of the drive.

3. Click *Next*.
4. This step depends on the backup destination selection:
 - a. If *Project* was selected, give the backup file a name and description.
 - b. If *Device file system* was selected, select where to save the backup. The selections are flash, RAM, or an (optional) microSD card. It is possible to specify a name for the backup file as well.
5. Click *Backup* to begin backup.



Once backup is completed, a notification screen about it appears. If a *Project* backup was created, the backup is shown in the device menu under *Parameters*.

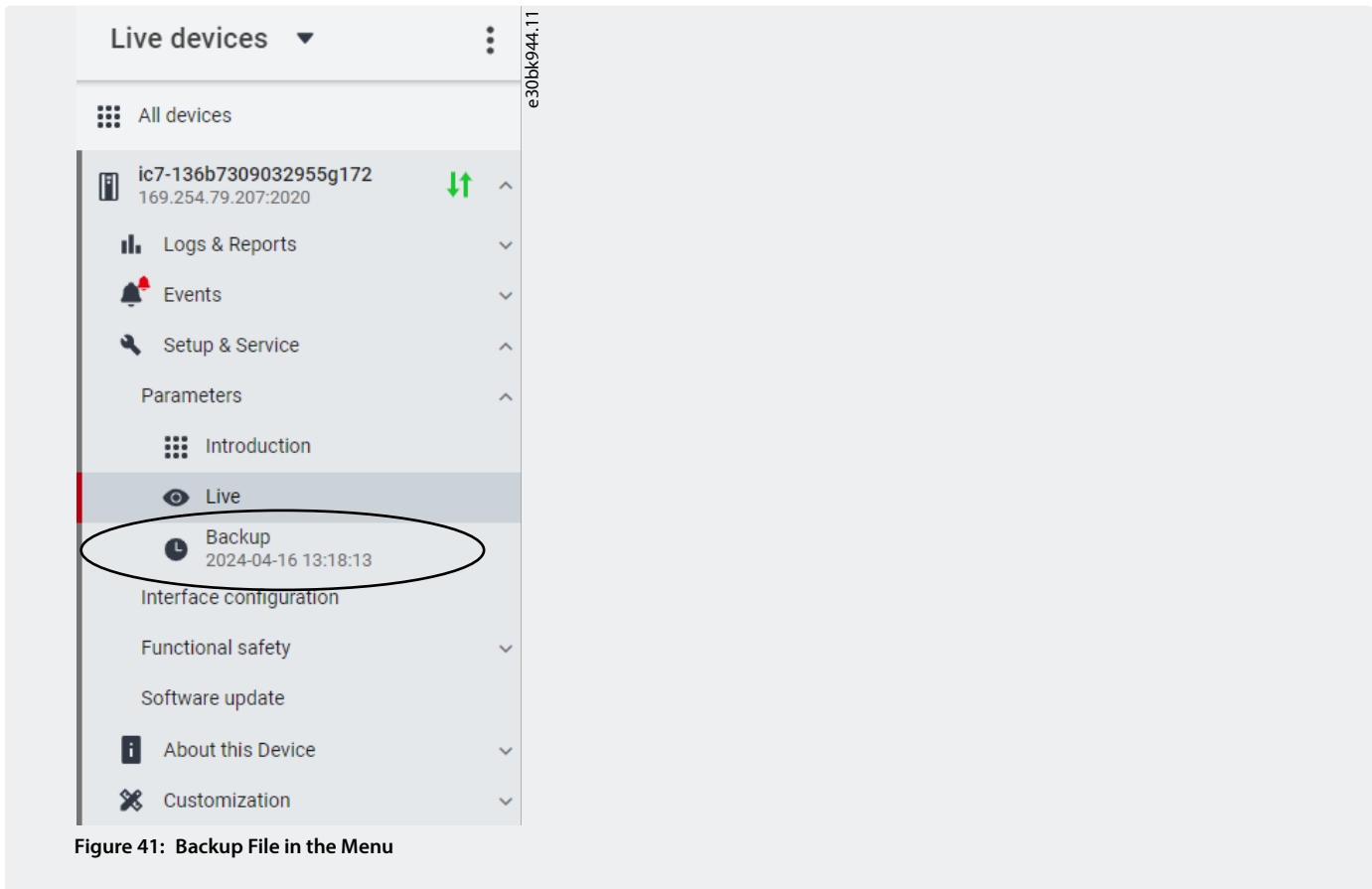

Figure 41: Backup File in the Menu

3.3.7.3 Restoring the Data to the Drive

1. To restore data to the drive, select a drive, and go to *Setup & Service > Parameters*.
2. Click the *Restore Data* icon shown in the following image.

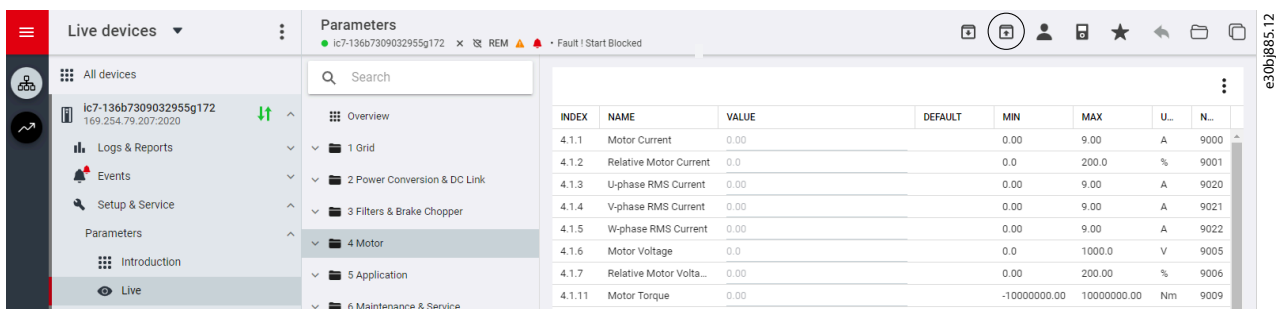

Figure 42: Restore Data Icon

3. Select the source of the data which is to be restored to the drive.

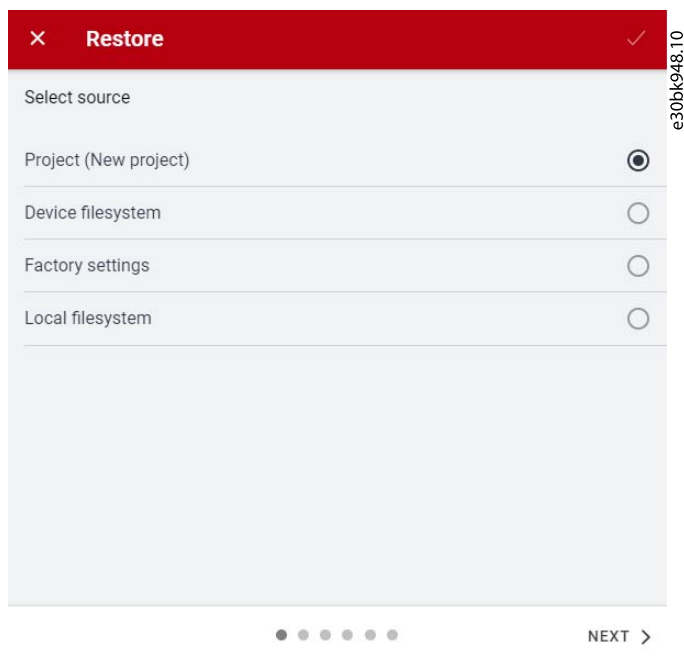

Figure 43: Source of Data to Restore

4. Click *Next* to select the backup source device and view the available backup files.
5. If *Project* is the restore source, select the correct backup to restore. Click *Next*.

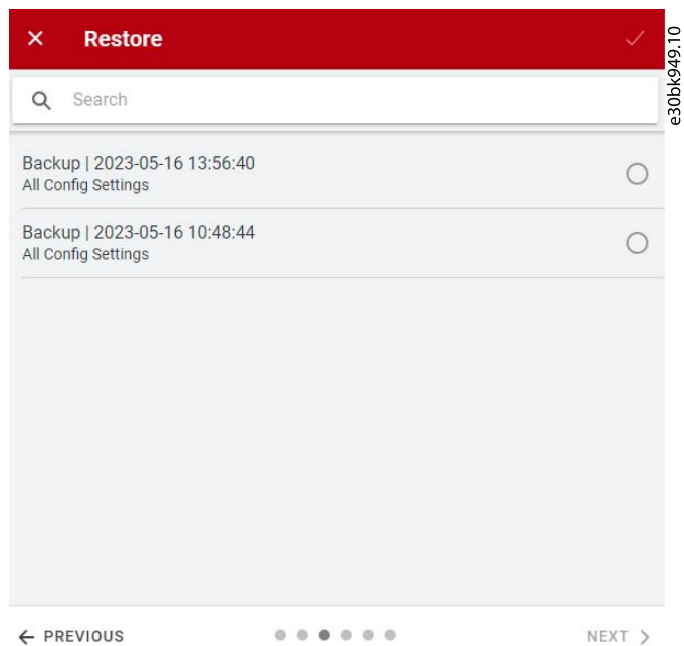

Figure 44: Select the Backup

6. The system shows a summary of the project to be restored and the device it will be restored to. Click *Next*.

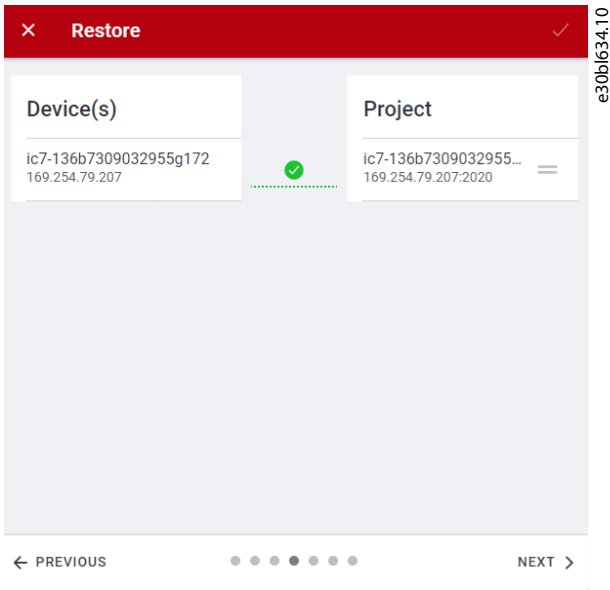

Figure 45: Restore summary

7. Select the files for restoring data into the drive, as shown in the following image, and click *Next*.

It is possible to include or exclude Ethernet port settings when restoring the data. It is also possible to restore customizations, such as Modbus interface mappings.

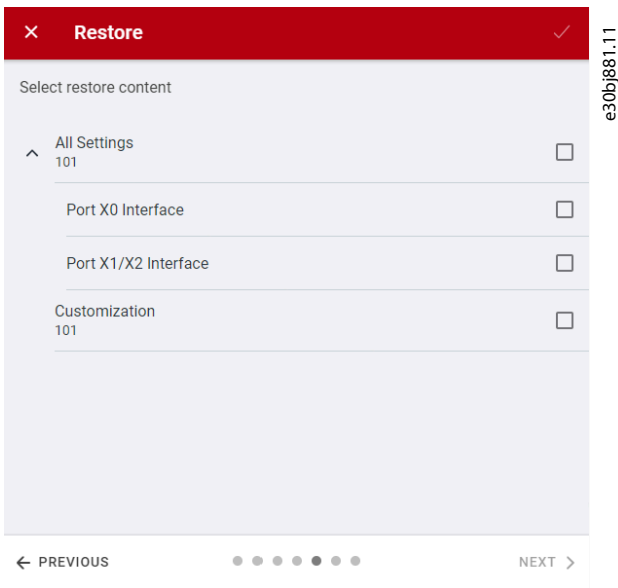

Figure 46: Restore Data

8. To confirm the restore action, click *Restore*.

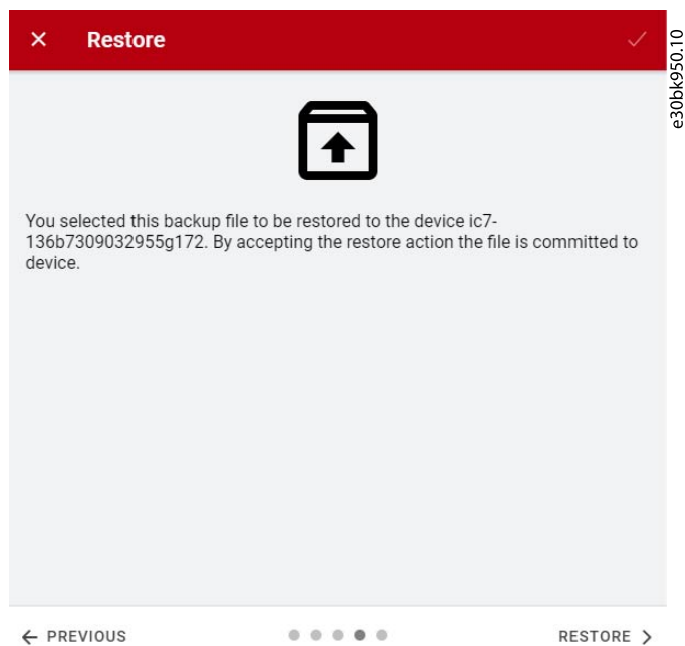

Figure 47: Confirm the Restore

If the data restore is successful, a message is shown.

4 Application Software Structure and Overview

4.1 Understanding Application Software Structure Principles

The basic design principle of the application software structure and the related hierarchy refers to the setup of a typical iC7 drive.

A similar application software structure is reused across all products within the iC7 series. This means that some of the parameter groups or dedicated parameters may not be visible for all applications. Therefore, the indexes of parameters may not be sequential. This design principle is followed to maintain consistency across all the different application software in the iC7 series. The application software is designed in this manner to have the same look and feel across different iC7 series products, and enable easier and faster troubleshooting.

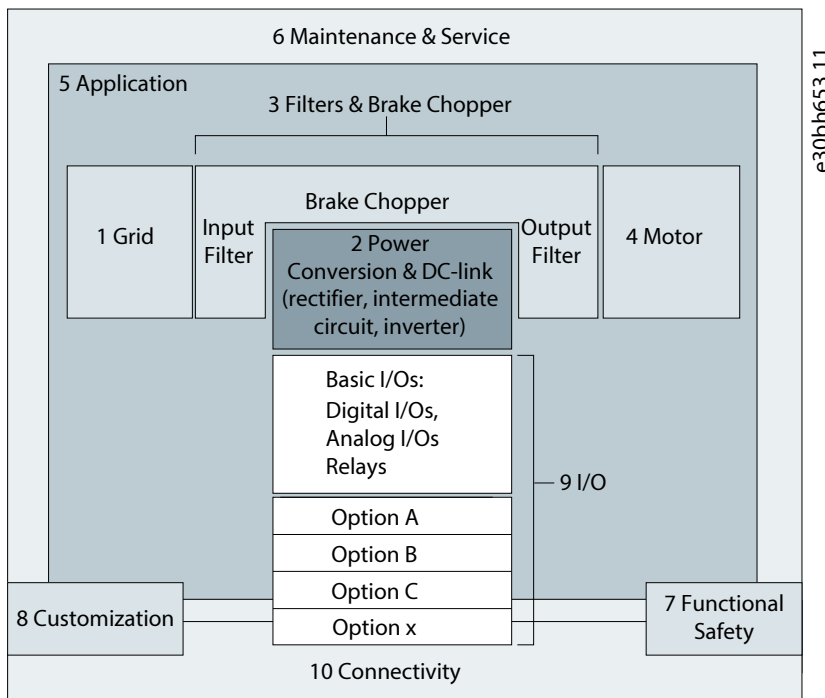

Figure 48: Application Software Structure Overview

4.2 Parameter Groups and their Content

The detailed structure and hierarchy within the parameter groups can vary, depending on the purpose of the parameter group and the total number of parameters. However, the design principle of the structure is to keep the overall sequence while commissioning or setting up the drive, within a logical structure. One example is the Status parameter group which is embedded into each main group (if applicable) to provide quick and easy access to view real time status information of relevant data of parameters within this group.

- All generic settings such as Grid, Power Conversion and DC Link, Filters and Brake Chopper, and Motor are accessed via parameter groups 1–4.
- Most of the application-specific parameters and the configuration of external control signals are accessed via parameter group 5 Application.
- Features and functions such as Maintenance and Service, Functional Safety, and Customization are accessed via parameter groups 6, 7, and 8.
- The hardware setup for the I/O interface, Options, and communication interfaces is done via parameter groups 9 and 10.
- The features and related parameters are grouped in individual parameter groups. Each feature has a parameter group of its own.
- Status information for each parameter group is available separately for easy access.
- The visibility of some parameters and parameter groups depends on the hardware used in the drive.

The following table provides information about the parameter groups.

Table 13: Parameter Groups

Index	Parameter group name	Description
1	Grid	Contains parameters for configuring and monitoring the energy source of the drive system. Typically, the energy source is the grid. The menu also lets you configure grid protection settings and view the condition of the grid.
2	Power Conversion and DC Link	Contains parameters to configure, monitor, and control the power conversion of the drive. The menu lets you configure protection settings of the power unit and settings for the rectifier, DC link, and inverter.
3	Filters and Brake Chopper	Contains parameters to configure, monitor, and control the input filters, output filters, brake chopper, and brake resistors.
4	Motor	Contains parameters to configure motor, motor control, and motor protection.
5	Application	Contains parameters for application specific features such as process control, speed control, torque control, mechanical brake control, and many more.
6	Maintenance and Service	Contains parameters exclusively related to status, events, and back up and restore.
7	Functional Safety	Contains non-safety-related parameters for configuring Safe Torque Off and other safety features.
8	Customization	Contains parameters to customize and adapt the behavior of the drive and user interface design.
9	I/O	Contains hardware-related parameters to configure I/Os and their options.
10	Connectivity	Contains parameters to configure the built-in and optional communications of the drive system.

Parameter group 1st level	Parameter group 2nd level	Parameter group 1st level	Parameter group 2nd level	Parameter group 1st level	Parameter group 2nd level
1 Grid	1.1 Grid Status	5 Application	5.1 Application Status	6 Maintenance & Service	6.1 Status
	1.2 Grid Settings		5.2 Protection		6.2 Software Information
	1.3 Grid Protection		5.3 Load		6.4 Events
2 Power Conversion & DC-link	2.1 Status		5.4 Operation Mode		6.5 Operational Counters
	2.2 Power Unit Settings		5.5 Control Places		6.7 Backup & Restore
	2.3 Protection		5.6 Start Settings	7 Functional Safety	7.1 Status
	2.4 Modulation		5.7 Stop Settings		7.2 STO
3 Filters & Brake Chopper	3.1 Filters & Brake Chopper Status		5.8 Speed Control	8 Customization	8.2 Basic Settings
	3.2 Brake Chopper		5.9 Torque Control		8.3 Control Panel
	3.3 Brake Resistor		5.10 Process Control	9 I/O	9.3 I/O Status
	3.4 Advanced Harmonic Filter		5.11 Inching		9.4 Digital Inputs/Outputs
	3.5 Output Filter		5.12 Mechanical Brake Control		9.5 Analog Inputs/Outputs
4 Motor	4.1 Motor Status		5.26 Additional Status Outputs	10 Connectivity	10.2 Communication Interfaces
	4.2 Motor Data		5.27 Fieldbus Process Data		10.3 Protocols
	4.3 Motor Control				
	4.5 Protection				

e30bk019.12

Figure 49: Parameter Groups

5 Configuration Set-up Examples

5.1 Configuration Prerequisites

The section covers the basic configuration steps of a drive. It is possible that the application requires more steps such as protection settings. Use the following topics as reference during the drive configuration/commissioning process:

- For control panel related configurations, see [3.2.3 Control Panel Basic Configurations](#).
- For information on using MyDrive Insight, see [3.3.2 Getting Started with MyDrive® Insight](#).
- For detailed information about the parameters, see *Parameter Descriptions*.

NOTICE

Ensure that the drive is mounted safely according to the installation and safety instructions shipped with the drive.

See also the following schematic for the correct wiring:

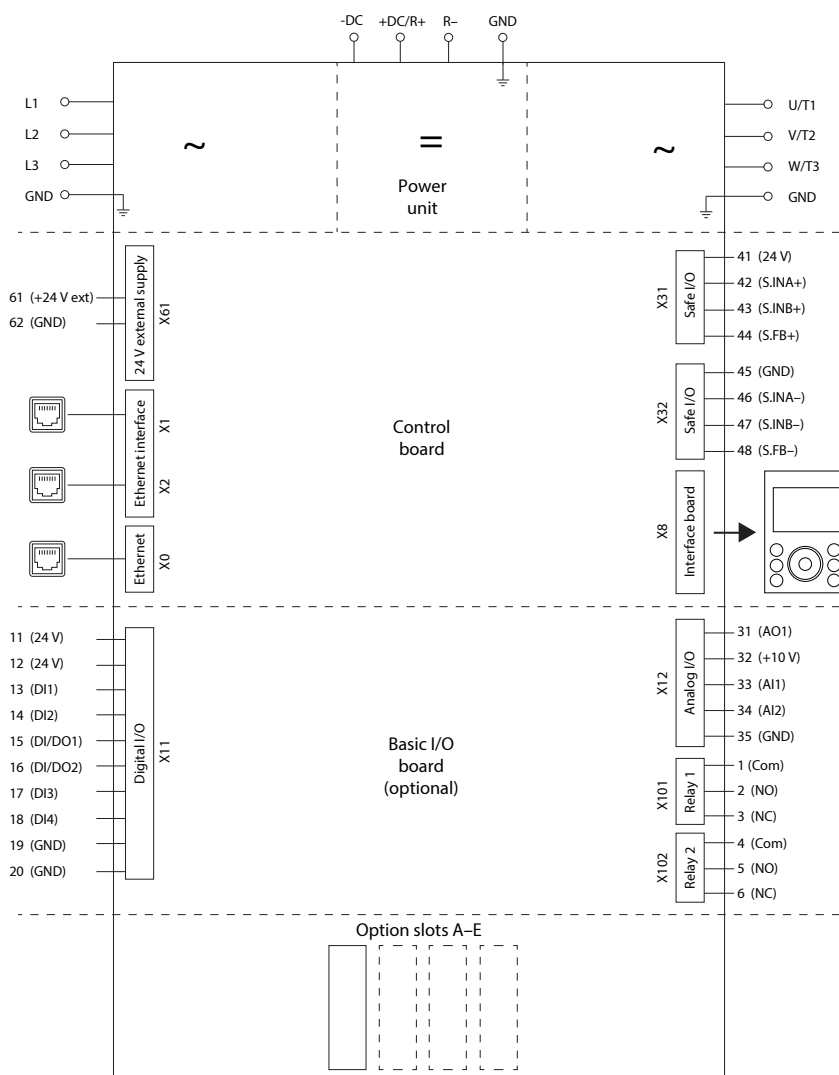

e30b387.11

Figure 50: Wiring Diagram



NOTE: Selection lists with inputs and/or outputs consist of the name of the hardware option and the numbers of the terminals. For example, terminal number 13 of the Basic I/O is called Basic I/O T13 in the selection list.

5.2 Basic Setup of a Drive

The basic setup of the drive consists of the following configuration steps.

1. Configure the grid settings.

Index	Parameter name	Example setting	Parameter number
1.2.1	Grid Type	TN	2942

2. Configure the power unit settings.

Index	Parameter name	Example setting	Parameter number
2.2.1.1	Unit Voltage Class	Low-voltage range	2832
2.2.1.2	Overload Mode	High overload (HO1)	2833

3. Configure the operating mode.

Index	Parameter name	Example setting	Parameter number
5.4.2.16	Operation Mode	Speed control	2500
5.4.2.19	Motor Feedback Mode	Open loop	2502

4. Configure the control place settings.

Index	Parameter name	Example setting	Parameter number
5.5.2.1	Control Place Selection	Advanced control	114
5.5.3.1.2	Local Control Mode	Allow local control	107
5.5.6.1.1	Advanced Start Input	Fieldbus start, Basic I/O T13	4722
5.5.6.1.2	Advanced Start Logic	Source 1	1933
5.5.6.1.7	Advanced Coast Inverse Input	Fieldbus coast, Basic I/O T16	4724
5.5.6.1.8	Advanced Coast Inverse Logic	Source 1	1936

5. Configure the fieldbus communications (if available). See the relevant fieldbus guide.
6. Configure the readouts in the control panel. See Understanding Readout Screens.

5.3 Configuring the Motor, Motor Control, and Motor Thermal Protection

The required configuration steps depend on the motor type selected in parameter **4.2.1.1 Motor Type**.

NOTICE

The parameters specified in motor configuration cannot be adjusted when the motor is running.

1. Configure basic motor data. Go to *Parameter group 4* and specify the following:

Index	Parameter name	Parameter setting	Parameter number
4.2.1.1	Motor Type	Induction motor or Permanent magnet motor	407
4.2.2.1	Nominal Power	As on motor product label.	405
4.2.2.2	Nominal Current	As on motor product label.	400
4.2.2.3	Nominal Speed	As on motor product label.	402
4.2.2.4	Nominal Frequency	As on motor product label.	403
4.2.2.5	Nominal Voltage	As on motor product label.	401



NOTE: Changing the product label data causes a reset of the advanced motor data to default values, and the loss of AMA results.

2. Perform Automatic Motor Adaptation (AMA).

The advanced motor data, which are needed for optimal motor control performance and which are described in step 3, can be entered manually or measured and calculated based on AMA. The data measurement must be conducted in standstill with the following parameter:

Index	Parameter name	Parameter setting	Parameter number
4.2.1.3	AMA Mode	Motor data	420



NOTE: AMA requires an active start signal for execution. After AMA is performed, the setting of AMA Mode automatically switches to Off, and a notification must be confirmed. A new start signal is required for starting the motor. This is to avoid an unintended start caused by the active start signal. Consult the iC7 Series Frequency Converters Installation Safety Guide for safety information on unintended start.

3. Configure the advanced motor data if AMA is not performed. Setting these parameters is recommended for optimal motor control performance.

Table 14: Asynchronous Induction Motors

Index	Parameter name	Parameter setting	Parameter number
4.2.3.1	Stator Resistance Rs	Result of AMA or as on motor data sheet.	408
4.2.3.2	Rotor Resistance Rr	Result of AMA or as on motor data sheet.	409

Table 14: Asynchronous Induction Motors (continued)

Index	Parameter name	Parameter setting	Parameter number
4.2.3.3	Iron Loss Resistance Rfe	Result of AMA or as on motor data sheet.	413
4.2.3.4	Stator Leakage Reactance Xls	Result of AMA or as on motor data sheet.	440
4.2.3.5	Rotor Leakage Resistance Xlr	Result of AMA or as on motor data sheet.	441
4.2.3.6	Magnetizing Reactance Xm	Result of AMA or as on motor data sheet.	442

Table 15: Permanent Magnet Motors

Index	Parameter name	Parameter setting	Parameter number
4.2.4.2	Stator Resistance Rs	Result of AMA or as on motor product label.	408
4.2.4.3	d-axis Inductance Ld	Result of AMA or as on motor product label.	417
4.2.4.4	d-axis Inductance LdSat	Result of AMA or as on motor product label.	418
4.2.4.5	Ld Saturation Point	Result of AMA or as on motor product label.	426
4.2.4.6	q-axis Inductance Lq	Result of AMA or as on motor product label.	427
4.2.4.7	q-axis Inductance LqSat	Result of AMA or as on motor product label.	422
4.2.4.8	Lq Saturation Point	Result of AMA or as on motor product label.	424
4.2.4.1	Back EMF	Only for Permanent Magnet Motors. as on motor data sheet, as specified at 1000 RPM.	415

4. Configure motor control.

Index	Parameter name	Parameter setting	Parameter number
4.3.1.1	Motor Control Principle	FVC+ Control	2503
4.3.3.1	Continuous Rs Estimation	Enabled	428

Note: For motor control principles VVC+ and U/f, the following applies:

- Configure compensations for slip and different application conditions in parameter group **4.3.4 VVC+ & U/f Settings**.
- Enable and configure Automatic Energy Optimization (AEO) in parameter group **5.3.3 Torque & AEO**.
- For U/f, define the voltage and frequency points in parameter group **4.3.2 U/f Settings** as required for the application.

5. Configure motor thermal protection.

The Electronic Thermal Relay (ETR) function protects the motor from thermal overload without connecting an external device, by estimating the motor temperature based on present load and time. The ETR function meets the relevant requirements of UL 61800-5-1, including the Thermal Memory Retention requirement, and ensures a class 20 protection level. ETR can be configured and the motor thermal load can be viewed using the following parameters:

Index	Parameter name	Parameter setting	Parameter number
4.5.4	ETR Overtemperature Response	Fault, ramp to coast	2825
4.1.16	Motor Thermal Load (ETR)	Varies (Readout)	2951

The fault **0x7120-4177 Motor Thermal Overload** is issued when the motor thermal load has reached 100%.

5.4 Configuring Speed Control

This section describes the basic configuration for speed control in open loop.

The following procedure describes the additional steps to control the speed according to the following wiring diagram.

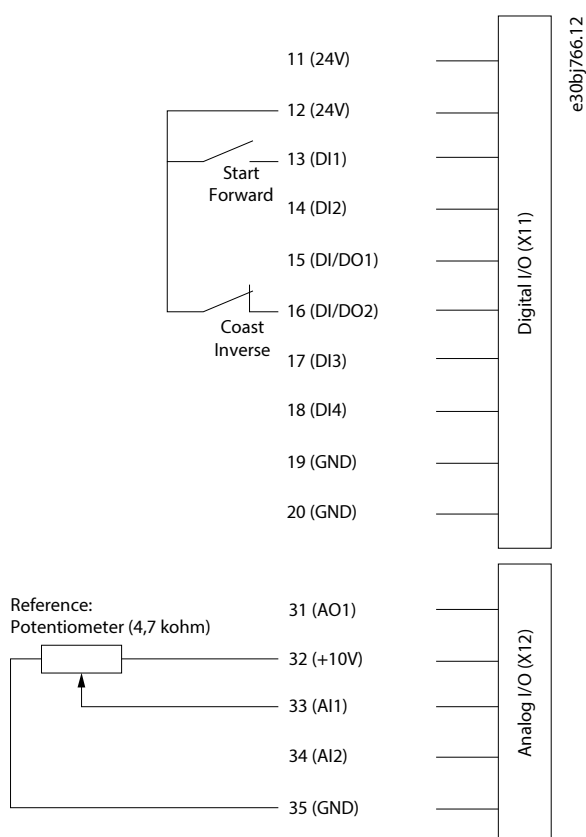

Figure 51: Wiring diagram example - Speed Control with Basic I/O

1. Perform the steps in [5.2 Basic Setup of a Drive](#).
2. Perform the steps in [5.3 Configuring the Motor, Motor Control, and Motor Thermal Protection](#).
3. Configure the operation mode for speed control.

Index	Parameter name	Example setting	Parameter number
5.4.2.16	Operation Mode	Speed control	2500
5.4.2.19	Motor Feedback Mode	Open loop	2502

4. Configure the type of speed reference used for the Advanced Control Place.

Index	Parameter name	Example setting	Parameter number
5.5.6.2.1	Adv. Speed Reference	Fieldbus reference, Reference 1 input	1915
5.5.6.2.2	Adv. Speed Reference Logic	Sum	1916

5. Configure speed limit settings.

Index	Parameter name	Example setting	Parameter number
5.8.3.1	Positive Speed Limit	1500 RPM	1729
5.8.3.2	Negative Speed Limit	-1500 RPM	1728
5.8.3.3	Minimum Speed Limit	0 RPM	1722

6. Configure the ramp.

Index	Parameter name	Example setting	Parameter number
5.8.6.1.1	Ramp Selector	Ramp 1	1100
5.8.6.2.1	Ramp 1 Type	Linear ramp	1125
5.8.6.2.2	Ramp 1 Accel. Time	5 s.	1101
5.8.6.2.3	Ramp 1 Decel. Time	5 s.	1105

7. Configure the reference and input settings according to the selected reference type.

Table 16: Reference Settings

Index	Parameter name	Example setting	Parameter number
5.8.4.1	Speed Reference 1 Input	Basic I/O T33	501
5.8.4.3	Speed Reference 1 Maximum	1500 RPM	1724
5.8.4.4	Speed Reference 1 Minimum	0 RPM	1725

Table 17: Basic I/O Settings

Index	Parameter name	Example setting	Parameter number
9.5.2.1	T33 Terminal Mode	Analog input	2020
9.5.2.2	T33 Terminal Type	Voltage	2273
9.5.2.3	T33 Minimum Value	0 V	2272
9.5.2.4	T33 Maximum Value	10 V	2271

8. Optional: Configure the settings for the Auto Tuning of the speed controller.

For achieving optimal motor control performance, perform an Inertia Estimation or, if the inertia is known, enter the inertia manually with parameter **5.3.2.3 System Inertia**.

Also perform an Auto Tuning of the speed controller settings. Auto tuning requires an inertia estimation value. Besides the settings already described, adjust the following:

Index	Parameter name	Example setting	Parameter number
5.8.11.1	Speed Controller Auto Tuning	Enabled	4546
5.3.2.1	Inertia Estimation Mode	Without load profile	668



NOTE: The recommended setting for parameter **5.3.2.1 Inertia Estimation Mode** depends on the torque characteristic configured with parameter **5.3.3.1 Torque Characteristic**. Select **Without load profile** if there is a constant torque load, and **With profile** for a variable torque load.

9. To start the tuning process, apply a start signal to terminal 13 of the Basic I/O .

5.5 Configuring Torque Control

While the drive is in torque control, the motor speed is monitored but not controlled. Therefore motor speed can reach the speed limits, when the load, application, or upper system are not within the speed limits. For this reason, it is important to set the limits of the output frequency as described in [5.4 Configuring Speed Control](#). Since speed ramps can also be used as limiting factor, check the ramp settings in step 6 of [5.4 Configuring Speed Control](#). Torque control is only available with the motor control principle FVC+.

The procedure is described according to the following wiring diagram.

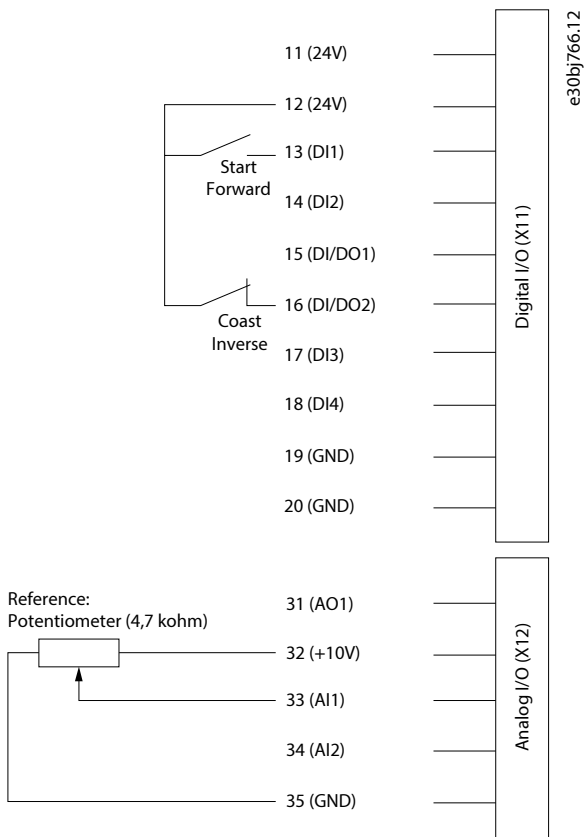

Figure 52: Wiring diagram example - Torque Control with Basic I/O

1. Perform the steps in 5.2 Basic setup of a Drive.
2. Perform the steps in 5.3 Configuring Motor, Motor Control, and Motor Thermal Protection.
3. Configure the operation mode for torque control.

Index	Parameter name	Example setting	Parameter number
5.4.2.16	Operation Mode	Torque control	2500

4. Configure the type of torque reference used for the Advanced Control Place.

Index	Parameter name	Example setting	Parameter number
5.5.6.2.4	Adv. Torque Reference	Fieldbus reference, Reference 1 input	1929
5.5.6.2.5	Adv. Torque Reference Logic	Sum	1919

5. Configure the torque limit settings.

Index	Parameter name	Example setting	Parameter number
5.9.2.1	Positive Torque Limit	150%	1810
5.9.2.2	Negative Torque Limit	-150%	1811
5.9.2.3	Motoring Torque Limit	100%	1321

Index	Parameter name	Example setting	Parameter number
5.9.2.4	Regenerative Torque Limit	100%	1323
5.9.2.5	Speed Limit Mode Torque Ctrl.	Pos./Neg. speed limit	2332

See more information about flexible limit modes in 6.6.9.3 Limits (Menu Index 5.9.2).

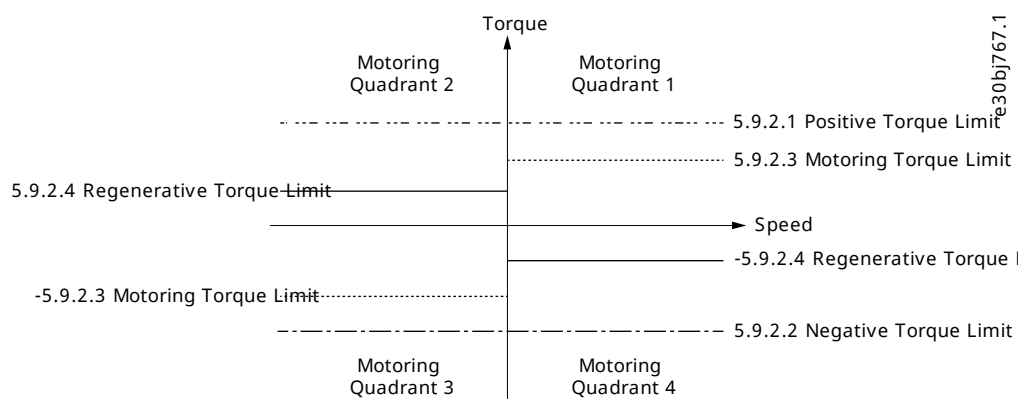

Figure 53: Torque Control Limits

- Configure the reference settings and terminals used for the reference signal.

Table 18: Reference Settings

Index	Parameter name	Example setting	Parameter number
5.9.3.1	Torque Reference 1 Input	Basic I/O T33	4534
5.9.3.3	Torque Reference 1 Maximum	100%	4530
5.9.3.4	Torque Reference 1 Minimum	0%	4531
5.9.3.14	Torque Reference Ramp Time	10 s.	2330

Table 19: Basic I/O Settings

Index	Parameter name	Example setting	Parameter number
9.5.2.1	T33 Terminal Mode	Analog input	2020
9.5.2.2	T33 Terminal Type	Voltage	2273
9.5.2.3	T33 Minimum Value	0 V	2272
9.5.2.4	T33 Maximum Value	10 V	2271

5.6 Configuring Process Control

The built-in process controller is used to control processes based on the feedback sensor signal. Examples of controlled process variables are flow, pressure, and temperature. The process controller is used as a reference source for the speed controller. For this reason, a pre-condition of configuring the process control is to follow the instructions in the basic setup of a drive, configuring motor and motor control, and configuring speed control.

The auto-tuning simplifies the configuration and saves time during commissioning, while ensuring accurate PID control adjustment. In addition, the built-in controller supports inverse control for applications such as level control or the control of a vacuum pump. In such applications, increasing the drive speed decreases the feedback value.

This section describes the extra configurations required to set up a basic pressure control loop according to the following illustration and wiring diagram.

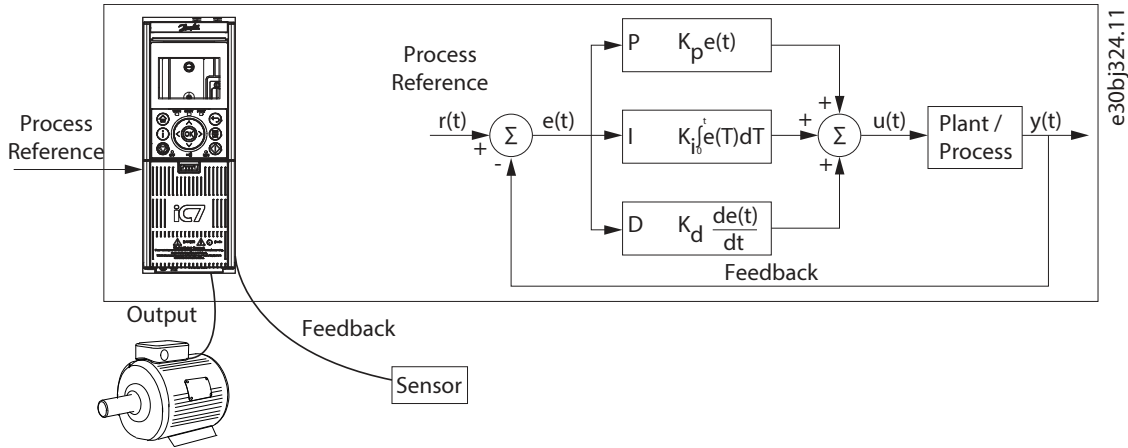

Figure 54: Process Controller

This configuration setup contains the following features:

- A pressure transducer to measure the pressure of the system. This data is used as feedback. The sensor is supplied power by the drive's 24 V supply.
- A potentiometer to adjust the setpoint, and a switch for the start signal which is connected to digital input 1 (terminal 13) on the Basic I/O. See the following wiring drawing example.

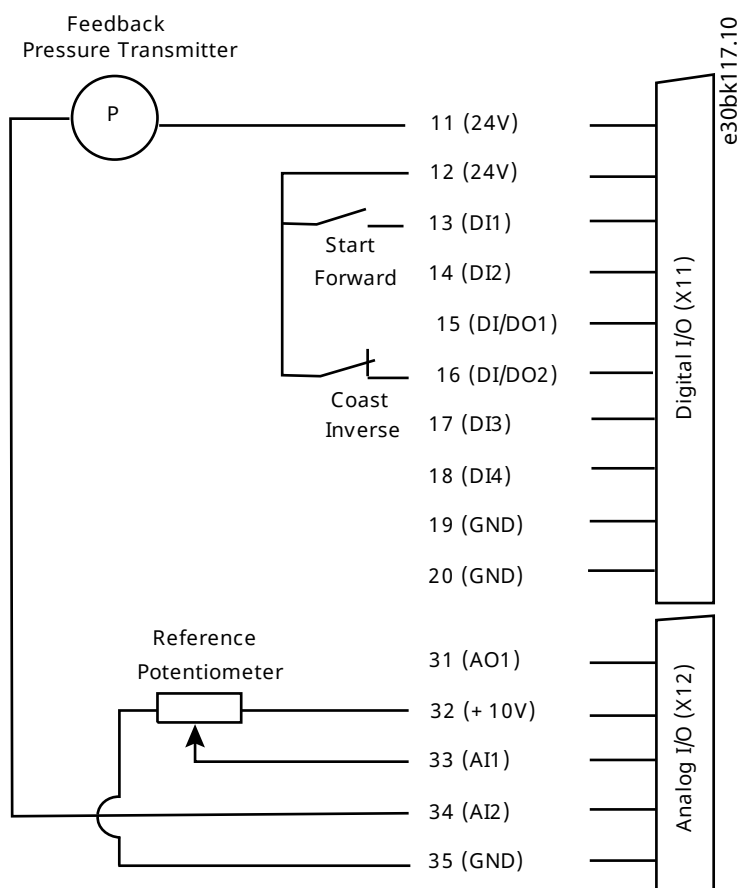

Figure 55: Wiring diagram example - Process Control with Basic I/O

1. Perform all the steps in [5.2 Basic Setup of a Drive](#).
2. Perform all the steps in [5.3 Configuring the Motor, Motor Control, and Motor Thermal Protection](#).
3. Perform all the steps in [5.4 Configuring Speed Control](#).
4. Select the process controller as reference in the settings for the control place.

Index	Parameter name	Recommended settings	Parameter number
5.5.6.2.6	Adv. Process Reference	Fieldbus reference/Reference 1 input	6054
5.5.6.2.7	Adv. Process Reference Logic	Source 1	6045

5. Adjust settings for the process reference and for the feedback according to the application. In this example, the operating range is 0–4 bar.

Index	Parameter name	Example setting	Parameter number
5.10.3.1	Process Reference Max.	4 bar	6013
5.10.3.2	Process Reference Min.	0 bar	6014
5.10.3.3	Process Reference 1 Input	Basic I/O T33	6025
5.10.4.1	Feedback Mode	Feedback 1	6008
5.10.4.2	Feedback 1 Type	Analog feedback terminal	6021

Index	Parameter name	Example setting	Parameter number
5.10.4.3	Feedback 1 Maximum Scaling	4 bar	6015
5.10.4.4	Feedback 1 Minimum Scaling	0 bar	6016
5.10.4.5	Analog Input Feedback 1	Basic I/O T34	6027

- Configure the electrical characteristics of the analog input terminals 33 and 34 for reference and feedback.

Table 20: Terminal 33 Settings

Index	Parameter name	Example setting	Parameter number
9.5.2.2	T33 Terminal Type	Voltage	2273
9.5.2.3	T33 Minimum Value	0 V	2272
9.5.2.4	T33 Maximum Value	10 V	2271

Table 21: Terminal 34 Settings

Index	Parameter name	Example setting	Parameter number
9.5.3.2	T34 Terminal Type	Current	2279
9.5.3.3	T34 Minimum Value	4 mA	2278
9.5.3.4	T34 Maximum Value	20 mA	2277

- To ensure optimum control performance for the system, perform auto-tuning of the process controller. The optimization of the settings is for the reference or a typical reference of the system.

Index	Parameter name	Example setting	Parameter number
5.10.7.1	Process Controller Auto Tuning	Enabled	6901
5.10.7.2	Auto Tuning Reference	2.3 bar	6902



NOTE: Default settings do not require modification before performing auto tuning.



NOTE: Parameter *5.10.7.1 Process Controller Auto Tuning* is disabled automatically after auto tuning is completed.

- To start auto-tuning, apply a start signal to terminal 13 of the Basic I/O.
- Enable the process controller.

Index	Parameter name	Example setting	Parameter number
5.10.1.10	Process Controller Enabled	Enabled	6053

10. In applications like pressure control with centrifugal pumps, additional energy savings can be achieved by using the Automatic Energy Optimization (AEO) function. To use this feature, configure the following parameters:

Index	Parameter name	Example setting	Parameter number
5.3.3.1	Torque Characteristic	Automatic Energy Optimization (AEO)	2809
5.3.3.2	AEO Minimum Speed	10 Hz	2810
5.3.3.3	AEO Minimum Magnetization	40%	2811



NOTE: To start the application a start signal is required, if the signal has been removed after completing auto-tuning.

5.7 Configuring a Latched Start/Stop with Digital I/O

A latched start/stop is often used in operating panels where the Start and Stop buttons are equipped with a spring return. A latching circuit locks its output once an input signal is applied, and keeps that position even after the input signal is detached.

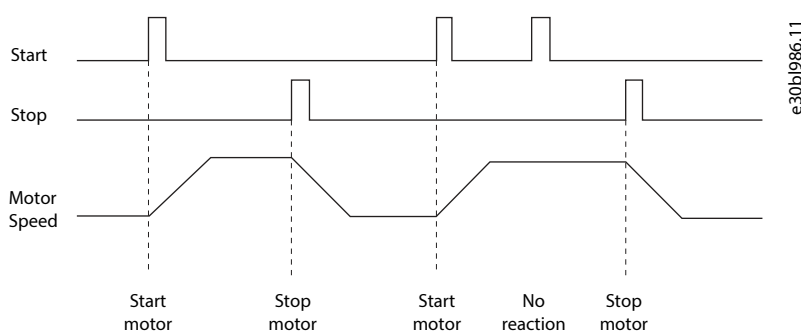

Figure 56: Latched Start/Stop Behavior

In this example, the functionality is set up with an analog speed reference with a scale of 0–10 V.

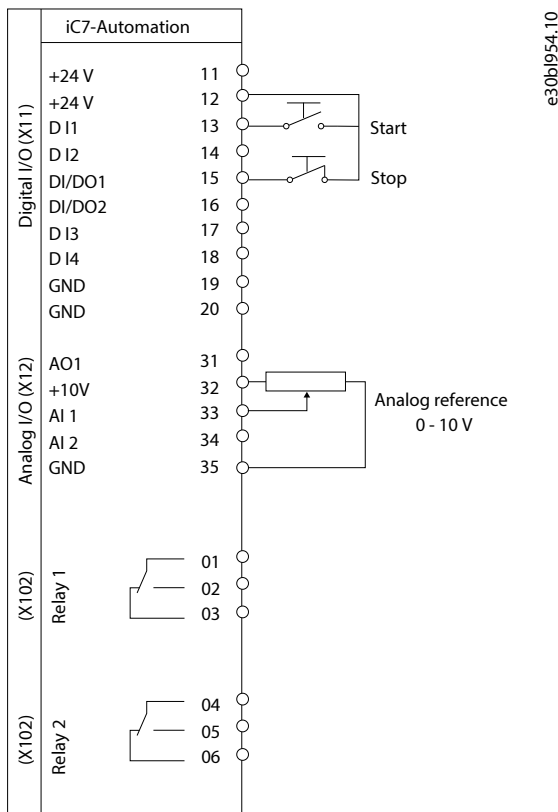

Figure 57: Latched Start/Stop Connections

1. Select I/O as the active control place. This selection affects the parameter group that is used to configure the start and stop signals.

Index	Parameter	Parameter setting	Parameter number
5.5.2.1	Control Place Selection	3 (I/O Control)	114

2. Set the start signal to a latched start by selecting **High Pulse Start**, and activate input T15 as the stop input.

Index	Parameter	Parameter setting	Parameter number
5.5.5.1.1	Start Input	Basic I/O T13 Digital Input	200
5.5.5.1.8	Start Signal Mode	2 (High Pulse Start)	211
5.5.5.1.3	Stop Inverse Input	Basic I/O T15 Digital Input	201

3. Set terminal T33 as the reference input with a signal between 0-10 V.

Index	Parameter	Parameter setting	Parameter number
9.5.2.2	T33 Terminal Type	1 (Voltage)	2273
9.5.2.3	T33 Minimum Value	0	2272
9.5.2.4	T33 Maximum Value	10	2271

6 Parameter Descriptions

6.1 Introduction to Parameter Descriptions

6.1.1 Reading the Parameter Table

The application guide includes parameter overview tables. The following descriptions explain how to read the parameters.

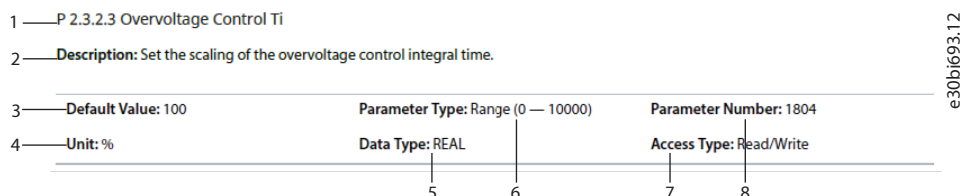

Figure 58: Reading the Parameter Table

1	The parameter index and name. Parameter indices start with a P.	2	The parameter help text which is visible in the control panel and MyDrive® Insight.
3	The default setting from the factory. If the parameter is a status readout parameter, the default is NA.	4	The unit of the parameter.
5	The data type of the parameter. See 6.1.2 Understanding Data Types .	6	The type of parameter. Parameters have either defined ranges of values or selections. See 6.1.3 Understanding Parameter Types .
7	The access type of the parameter. See 6.1.4 Understanding Access Types .	8	The unique parameter number, which is relevant for PLC programming.

6.1.2 Understanding Data Types

The following table is an overview of the data types used in the iC7 application software.

Table 22: Overview of data types

Data type	Description	Size (Bits)	Range
BOOL	Boolean	1	0–1
INT	Integer	16	-32,768 ... 32,767
DINT	Double integer	32	-2,147,483,648 ... 2,147,483,647
USINT	Unsigned short integer	8	0–255
UINT	Unsigned integer	16	0–65,535
UDINT	Unsigned double integer	32	0–4,294,967,295
REAL	Real numbers	32	-3.402823466 E+38 (approximately 7 digits) ... -1.175494351 E-38 (approximately 7 digits) and +1.175494351 E-38 (approximately 7 digits) ... +3.402823466 E+38 (approximately 7 digits)
WORD	Bit string of length 16	16	0–65,535 (16#00–16#FFFF)
STRING	Sequence of characters	N/A	1 byte per character
ULINT	Unsigned long integer	64	0–18,446,744,073,709,551,615
DATE_AND_TIME	Date and time information	64	N/A

6.1.3 Understanding Parameter Types

The following table lists the different types of parameters.

Table 23: Parameter Types and Descriptions

Parameter Type	Description
Selection	The parameter provides a list of value selections.
Range (0–255)	The value of the parameter is within the specified range. In this example, the parameter can have any value between 0 and 255.
Range (*–*)	The value of the parameter can be set within the full range of the data type REAL. See 6.1.2 Understanding Data Types .
Range (0–*)	The value of the parameter can be set within the upper range of the data type REAL. See 6.1.2 Understanding Data Types .
Range (Unit dependent)	The range depends on the selected unit, and is visible in MyDrive Insight and the Control Panel.

6.1.4 Understanding Access Types

The following table lists the different parameter access types.

Table 24: Parameter Types and Descriptions

Access Type	Description
Read/Write	The parameter information can be read or changed.
Read only	The parameter information can only be read.
Read/Conditional Write	The parameter information can be read and changed. The parameter settings cannot be modified when the drive is running. The drive must be coasted to modify parameter values.

6.2 Grid (Menu Index 1)

6.2.1 Grid Overview

This parameter group contains parameters for configuring and monitoring the energy source of the drive system. Typically, the energy source is the grid. The menu also lets the user configure grid protection settings and view the condition of the grid.

6.2.2 Grid Status (Menu Index 1.1)

P 1.1.1 Grid Frequency

Shows the actual grid frequency.

Default Value:	NA	Parameter Type:	Range (* — *)
Parameter Number:	9041	Unit:	Hz
Data Type:	REAL	Access Type:	Read Only

P 1.1.2 Line-To-Line Voltage (RMS)

Shows the average line-to-line voltage (RMS).

Default Value:	NA	Parameter Type:	Range (0 — *)
Parameter Number:	9040	Unit:	V

Data Type:	REAL	Access Type:	Read Only
-------------------	------	---------------------	-----------

P 1.1.3 L1-L2 Line Voltage (RMS)

Shows the L1-L2 line voltage (RMS).

Default Value:	NA	Parameter Type:	Range (0 — *)
Parameter Number:	9048	Unit:	V
Data Type:	REAL	Access Type:	Read Only

P 1.1.4 L2-L3 Line Voltage (RMS)

Shows the L2-L3 line voltage (RMS).

Default Value:	NA	Parameter Type:	Range (0 — *)
Parameter Number:	9049	Unit:	V
Data Type:	REAL	Access Type:	Read Only

P 1.1.5 L3-L1 Line Voltage (RMS)

Shows the L3-L1 line voltage (RMS).

Default Value:	NA	Parameter Type:	Range (0 — *)
Parameter Number:	9050	Unit:	V
Data Type:	REAL	Access Type:	Read Only

P 1.1.6 Grid Voltage Imbalance

Shows the grid voltage imbalance in %. A value greater than 3% may indicate grid problems.

Default Value:	NA	Parameter Type:	Range (0 — 100)
Parameter Number:	9047	Unit:	%
Data Type:	REAL	Access Type:	Read Only

P 1.1.7 Total Harmonic Distortion (THDv)

Shows the total harmonic distortion of the grid voltage (THDv) in %.

Default Value:	NA	Parameter Type:	Range (0 — 100)
Parameter Number:	9046	Unit:	%
Data Type:	REAL	Access Type:	Read Only

P 1.1.8 Grid Current

Shows the current at the point of common coupling.

Default Value:	NA	Parameter Type:	Range (0 — *)
Parameter Number:	9060	Unit:	A
Data Type:	REAL	Access Type:	Read Only

P 1.1.9 Grid Current %

Shows the current at the point of common coupling in % of grid nominal current. The grid nominal current is defined in Grid Settings.

Default Value:	NA	Parameter Type:	Range (-1000 — 1000)
Parameter Number:	9061	Unit:	%
Data Type:	REAL	Access Type:	Read Only

P 1.1.10 Grid Active Current %

Shows the active current in % of grid nominal current.

Default Value:	NA	Parameter Type:	Range (-1000 — 1000)
Parameter Number:	9062	Unit:	%
Data Type:	REAL	Access Type:	Read Only

P 1.1.11 Grid Reactive Current %

Shows the reactive current in % of grid nominal current.

Default Value:	NA	Parameter Type:	Range (-300 — 300)
Parameter Number:	9063	Unit:	%
Data Type:	REAL	Access Type:	Read Only

P 1.1.12 Grid Active Power

Shows the active power at the point of grid connection.

Default Value:	NA	Parameter Type:	Range (* — *)
Parameter Number:	9064	Unit:	kW
Data Type:	REAL	Access Type:	Read Only

P 1.1.13 Grid Active Power %

Shows the grid active power in % of grid nominal power.

Default Value:	NA	Parameter Type:	Range (-1000 — 1000)
Parameter Number:	9065	Unit:	%
Data Type:	REAL	Access Type:	Read Only

P 1.1.14 Grid Reactive Power

Shows the grid reactive power.

Default Value:	NA	Parameter Type:	Range (* — *)
Parameter Number:	9051	Unit:	kVA
Data Type:	REAL	Access Type:	Read Only

P 1.1.15 Grid Reactive Power %

Shows the grid reactive power in % of grid nominal power.

Default Value:	NA	Parameter Type:	Range (-1000 — 1000)
----------------	----	-----------------	----------------------

Parameter Number: 9052	Unit: %
Data Type: REAL	Access Type: Read Only

P 1.1.16 Grid Power Factor

Shows the grid power factor.

Default Value: NA	Parameter Type: Range (-1 — 1)
Parameter Number: 9053	Unit: –
Data Type: REAL	Access Type: Read Only

6.2.3 Grid Settings (Menu Index 1.2)

P 1.2.1 Grid Type

Select the grid type of the supply system. If set to "As grid type", the selection affects the setting of "1.2.2 RFI filter" and "2.2.1.7 HF DC-link Filter Mode".

Default Value: 0 (TN)	Parameter Type: Selection
Parameter Number: 2942	Unit: –
Data Type: UINT	Access Type: Read/Conditional Write

The following are the selections for the parameter.

Selection Number	Selection Name	Selection Description
0	TN	Drive connected to a TN grid.
1	TT	Drive connected to a TT grid.
2	IT	Drive connected to a IT grid.
3	HRG	Drive connected to a High Resistance Grid (HRG).
4	Grounded Delta	Drive is connected to a grounded delta grid.

P 1.2.2 RFI Filter Mode

Select the Radio Frequency Interference (RFI) filter mode.

Default Value: *	Parameter Type: Selection
Parameter Number: 2943	Unit: –
Data Type: UINT	Access Type: Read/Conditional Write

The following are the selections for the parameter.

Selection Number	Selection Name	Selection Description
0	Filter inactive	The filter is inactive.
1	Filter active	The filter is active.
2	Filter matches grid type selection	The filter is set according to the selected grid type.

6.2.4 Grid Protection (Menu Index 1.3)

P 1.3.1 Invalid Frequency Response

Select the response after detecting an invalid grid frequency.

Default Value:	1 (Fault)	Parameter Type:	Selection
Parameter Number:	2337	Unit:	–
Data Type:	UINT	Access Type:	Read/Write

The following are the selections for the parameter.

Selection Number	Selection Name	Selection Description
1	Fault	The drive issues a fault and stops.
2	Automatically derate	The drive continues operation with derated performance.

P 1.3.2 Missing Grid Phase Response

Select the response after detecting a missing grid phase.

Default Value:	1 (Fault)	Parameter Type:	Selection
Parameter Number:	2338	Unit:	–
Data Type:	UDINT	Access Type:	Read/Write

The following are the selections for the parameter.

Selection Number	Selection Name	Selection Description
1	Fault	The drive issues a fault and stops.
2	Automatically derate	The drive continues operation with derated performance.
3	Warning	The drive issues a warning.

P 1.3.3 Undervoltage Protection

Enables the undervoltage protection. The drive trips when the grid voltage is 20% below the selected voltage class level. The voltage class is defined with parameter "2.2.1.1 Unit Voltage Class".

Default Value:	1 (Enabled)	Parameter Type:	Selection
Parameter Number:	2344	Unit:	–
Data Type:	BOOL	Access Type:	Read/Write

The following are the selections for the parameter.

Selection Number	Selection Name	Selection Description
0	Disabled	Disables the function.
1	Enabled	Enables the function.

P 1.3.9 Grid Voltage Imbalance Response

Select the mode of grid imbalance protection.

Default Value:	1 (Fault or Warning)	Parameter Type:	Selection
Parameter Number:	9056	Unit:	–
Data Type:	UINT	Access Type:	Read/Write

The following are the selections for the parameter.

Selection Number	Selection Name	Selection Description
0	Off	Disables the protection.
1	Fault or Warning	Issues a warning or fault if a grid voltage imbalance is detected.
2	Automatically derate	The drive continues operation with derated performance.

P 1.3.10 Grid Spike Response

Select the response to grid voltage spike monitoring. If large spikes occur, the response protects the drive.

Default Value:	3 (Warning)	Parameter Type:	Selection
Parameter Number:	2342	Unit:	–
Data Type:	UINT	Access Type:	Read/Write

The following are the selections for the parameter.

Selection Number	Selection Name	Selection Description
3	Warning	The drive issues a warning.
9	Fault, ramp to coast	Issues a fault, ramps down, and coast.

6.3 Power Conversion & DC Link (Menu Index 2)

6.3.1 Power Conversion & DC-Link Overview

This parameter group contains parameters for configuring, monitoring, and controlling the power conversion of the drive. The group lets the user configure protection settings of the power unit and settings for the rectifier, DC link, and inverter.

6.3.2 Power Conversion & DC Link Status (Menu Index 2.1)

P 2.1.1 Unit Nominal Voltage

Shows the nominal voltage setting as a result of the setting of parameter "2.2.1.1 Unit Voltage Class".

Default Value:	400	Parameter Type:	Range (0 — *)
Parameter Number:	2830	Unit:	V
Data Type:	REAL	Access Type:	Read Only

P 2.1.2 Unit Nominal Current

Shows the nominal current of the unit.

Default Value:	23	Parameter Type:	Range (0 — *)
-----------------------	----	------------------------	----------------

Parameter Number:	2831	Unit:	A
Data Type:	REAL	Access Type:	Read Only

P 2.1.3 DC-link Voltage

Shows the actual DC-link voltage.

Default Value:	NA	Parameter Type:	Range (0 — *)
Parameter Number:	9044	Unit:	V
Data Type:	REAL	Access Type:	Read Only

P 2.1.7 DC-link Power

Shows the actual DC-link power.

Default Value:	NA	Parameter Type:	Range (* — *)
Parameter Number:	5117	Unit:	kW
Data Type:	REAL	Access Type:	Read Only

P 2.1.10 U-phase RMS Current

Shows the U-phase RMS current.

Default Value:	NA	Parameter Type:	Range (0 — *)
Parameter Number:	9020	Unit:	A
Data Type:	REAL	Access Type:	Read Only

P 2.1.11 V-phase RMS Current

Shows the V-phase RMS current.

Default Value:	NA	Parameter Type:	Range (0 — *)
Parameter Number:	9021	Unit:	A
Data Type:	REAL	Access Type:	Read Only

P 2.1.12 W-phase RMS Current

Shows the W-phase RMS current.

Default Value:	NA	Parameter Type:	Range (0 — *)
Parameter Number:	9022	Unit:	A
Data Type:	REAL	Access Type:	Read Only

P 2.1.14 Actual Relative Output Current Limit

Shows the actual output current limit relative to the nominal motor current.

Default Value:	NA	Parameter Type:	Range (0 — 300)
Parameter Number:	2700	Unit:	%
Data Type:	REAL	Access Type:	Read Only

P 2.1.15 Heat Sink Temperature

Shows the temperature of the power unit heat sink.

Default Value:	NA	Parameter Type:	Range (-50 — 200)
Parameter Number:	2950	Unit:	°C
Data Type:	REAL	Access Type:	Read Only

P 2.1.16 Main Fan Speed

Shows the speed of the main cooling fan.

Default Value:	NA	Parameter Type:	Range (0 — 32767)
Parameter Number:	2931	Unit:	rpm
Data Type:	INT	Access Type:	Read Only

P 2.1.17 Internal Fan Speed

Shows the speed of the internal cooling fan.

Default Value:	NA	Parameter Type:	Range (0 — 32767)
Parameter Number:	2926	Unit:	rpm
Data Type:	INT	Access Type:	Read Only

P 2.1.19 Heat Sink Temperature Output

Select the output indicating if the heat sink temperature is within the specified range.

Default Value:	–	Parameter Type:	Selection
Parameter Number:	2312	Unit:	–
Data Type:	UINT	Access Type:	Read/Write

P 2.1.20 Drive DC-link Voltage Output

Select the output indicating if the DC-link voltage is within the specified range.

Default Value:	–	Parameter Type:	Selection
Parameter Number:	2311	Unit:	–
Data Type:	UINT	Access Type:	Read/Write

6.3.3 Power Unit Settings (Menu Index 2.2)

6.3.3.1 General Settings (Menu Index 2.2.1)

P 2.2.1.1 Unit Voltage Class

Select the unit voltage class to optimize the performance of the drive.

Default Value:	*	Parameter Type:	Selection
Parameter Number:	2832	Unit:	–
Data Type:	UINT	Access Type:	Read/Conditional Write

The following are the selections for the parameter.

Selection Number	Selection Name	Selection Description
1	Low-voltage range	Class 1 - Low-voltage range.
2	Mid-voltage range	Class 2 - Mid-voltage range.
3	High-voltage range	Class 3 - High-voltage range.

This parameter specifies a focused voltage range within the input voltage rating of the power unit, for optimized drive control. Each power unit is rated for a wide input voltage range within which the drive can operate. This parameter is used to specify a narrower range within the wide range of input voltage, to determine optimized values for the nominal voltage and current of the power unit. The following table describes the selections available for the parameter.

Table 25: Selection Descriptions

Selection Name	Selection Description
Low Voltage Range	Unit nominal voltage and current are configured according to the lowest voltage of the power unit's voltage range. For example: In 380–500 V (3N05) rated units, the range is 380–440 V AC.
Medium Voltage Range	Unit nominal voltage and current are configured according to the medium voltage level of the power unit's voltage range. For example: In 380–500 V (3N05) rated units, the range is 441–480 V AC.
High Voltage Range	Unit nominal voltage and current are configured according to the highest voltage level of the power unit's voltage range. For example: In 380–500 V (3N05) rated units, the range is 481–500 V AC.

P 2.2.1.2 Overload Mode

Select the overload mode.

Default Value:	*	Parameter Type:	Selection
Parameter Number:	2833	Unit:	–
Data Type:	UINT	Access Type:	Read/Conditional Write

The following are the selections for the parameter.

Selection Number	Selection Name	Selection Description
0	Automatic	Combination of high and low overload. Drive will start at high overload, but switches to low overload for a period at too high load.
1	Low overload (LO)	Low overload (LO) operation. Provides overload current up to 110%.
2	High overload (HO1)	High overload (HO1) operation. Provides higher overload current up to 160% for acceleration.
3	High overload increased duty (HO2)	High overload with increased duty (HO2) operation. Provides higher overload current with shorter cycle times.

When configuring a drive, it is important to know the load characteristic and load cycle of the application, so that it is possible to get the most out of the drive. The available output current depends on the application load profile. In addition, derating of the output current may be needed, for example, if operational temperature is increased, or the drive is installed in an altitude above 1000 m (3300 ft).

iC7-Automation drives support 4 different overload modes:

- Low overload (LO): 110% load for a minimum of 1 minute every 10 minutes.
- High overload (HO1): Up to 160% load for 1 minute every 10 minutes, with a breakaway torque of up to 200%.
- High overload with increased duty (HO2): In drive parameters, this mode is called High overload (HO2). Up to 160% load for 1 minute every 5 minutes and with a breakaway torque of up to 200% in the start of the process.
- Automatic: In this mode, the drive automatically switches between LO and HO1 depending on the load conditions.

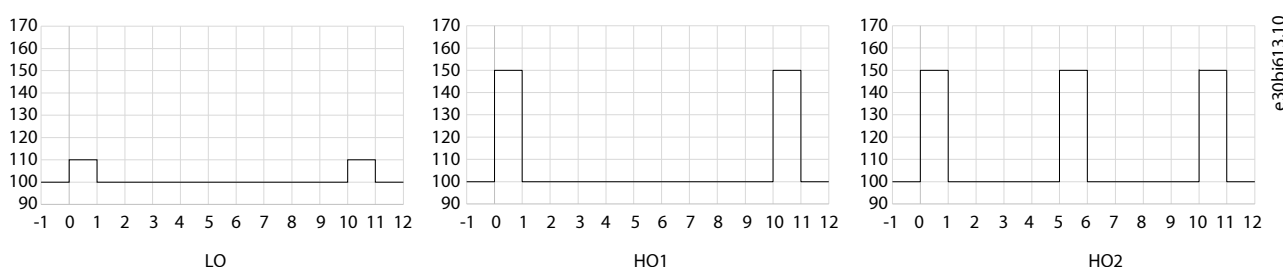

Figure 59: Overload Modes

Table 26: Selection Descriptions

Selection Name	Selection Description
Automatic Mode	Automatically switches between the modes Low Overload (LO) and High Overload (HO1).
Low Overload Mode (LO)	For applications running at a non-varying or slowly varying load, where a limited overload capability is required. This mode is typically used in applications with a variable torque load. The low overload profile allows the drive to run at 110% load for a minimum of 1 minute every 10 minutes. Typical applications where the low overload profile is used are: <ul style="list-style-type: none"> • Fans • Centrifugal pumps • Blowers and aerators • Screw compressors

Table 26: Selection Descriptions (continued)

Selection Name	Selection Description
High Overload Mode (HO1)	<p>For applications which require higher short-term overload and constant torque operations. Typical applications work with continuous motion. With high overload mode HO1, the drive can run with a load of up to 160% for 1 minute every 10 minutes, with a breakaway torque of up to 200%, depending on size. Typical applications where high overload HO1 is used are:</p> <ul style="list-style-type: none"> • Conveyors • Centrifuges • Decanters • Piston compressors • Piston pumps • Mixers • Stirrers • Escalators • Extruders (continuous running)
High Overload Mode (HO2)	<p>Used when the application has intermittent or continuous periodic duty. The resulting cyclic load requires more considerations on the use of the drive to ensure necessary performance and lifetime. Increased short-term starting torque is often also required. To benefit from the increased dynamic performance and not compromising lifetime, the output current is downrated by one motor size compared to HO1. With the high overload profile with increased duty, the drive can run with up to 160% load for 1 minute every 5 minutes, with a breakaway torque of up to 200%, depending on the current rating. Typical applications where the high overload profile with increased duty is used are:</p> <ul style="list-style-type: none"> • Extruders • Continuously accelerating conveyors • Lifts and hoists • Cranes • Positioning applications • Dosing pumps

P 2.2.1.3 Relative Output Current Limit

Set the output current limit relative to the motor nominal current from the nameplate.

Default Value:	150	Parameter Type:	Range (0 — 999)
Parameter Number:	1325	Unit:	%
Data Type:	REAL	Access Type:	Read/Write

P 2.2.1.5 Supply Mode

Select the supply mode.

Default Value:	0 (AC)	Parameter Type:	Selection
Parameter Number:	1328	Unit:	–
Data Type:	UINT	Access Type:	Read/Conditional Write

The following are the selections for the parameter.

Selection Number	Selection Name	Selection Description
0	AC	Drive is supplied from AC grid.
1	DC	Drive is supplied from DC terminals.

P 2.2.1.7 HF DC-link Filter Mode

Select the mode of the high-frequency filter in the DC link.

Default Value:	*	Parameter Type:	Selection
Parameter Number:	2944	Unit:	–
Data Type:	UINT	Access Type:	Read/Conditional Write

The following are the selections for the parameter.

Selection Number	Selection Name	Selection Description
0	Filter inactive	The filter is inactive.
1	Filter active	The filter is active.
2	Filter matches grid type selection	The filter is set according to the selected grid type.

P 2.2.1.8 Relative Power Limit Motor

Set the power limit in motor mode in % of nominal motor power.

Default Value:	300	Parameter Type:	Range (0 — 1000)
Parameter Number:	1814	Unit:	%
Data Type:	REAL	Access Type:	Read/Write

P 2.2.1.9 Relative Power Limit Generator

Set the power limit in generator mode in % of nominal motor power.

Default Value:	300	Parameter Type:	Range (0 — 1000)
Parameter Number:	1815	Unit:	%
Data Type:	REAL	Access Type:	Read/Write

P 2.2.1.12 Output Current Limit Scale Input

Select the input for scaling the output current limit between 0% and 100% of the defined current limit. Off equals 100%.

Default Value:	–	Parameter Type:	Selection
Parameter Number:	1322	Unit:	–
Data Type:	UINT	Access Type:	Read/Write

P 2.2.1.13 Output Current Limit Response

Select the response for running at the current limit after the time delay set.

Default Value:	0 (No response)	Parameter Type:	Selection
Parameter Number:	2359	Unit:	–
Data Type:	UINT	Access Type:	Read/Write

The following are the selections for the parameter.

Selection Number	Selection Name	Selection Description
0	No response	The event is ignored.
1	Info	The event is logged in the event log.
10	Fault	The drive issues a fault and coasts the motor.

P 2.2.1.14 Output Current Limit Delay

Set the delay before the selected response is triggered after the drive has reached the current limit.

Default Value:	–	Parameter Type:	Range (0 — 65000)
Parameter Number:	2360	Unit:	s
Data Type:	REAL	Access Type:	Read/Write

P 2.2.1.15 Power Limit Motor Response

Select the response for running at the power limit after the time delay set.

Default Value:	0 (No response)	Parameter Type:	Selection
Parameter Number:	2366	Unit:	–
Data Type:	UINT	Access Type:	Read/Write

The following are the selections for the parameter.

Selection Number	Selection Name	Selection Description
0	No response	The event is ignored.
1	Info	The event is logged in the event log.
10	Fault	The drive issues a fault and coasts the motor.

P 2.2.1.16 Power Limit Motor Delay

Set the delay before the selected response is triggered after the drive has reached the power limit.

Default Value:	–	Parameter Type:	Range (0 — 65000)
Parameter Number:	2364	Unit:	s
Data Type:	REAL	Access Type:	Read/Write

P 2.2.1.17 Power Limit Generator Response

Select the response for running at the power limit after the time delay set.

Default Value:	0 (No response)	Parameter Type:	Selection
Parameter Number:	2367	Unit:	–
Data Type:	UINT	Access Type:	Read/Write

The following are the selections for the parameter.

Selection Number	Selection Name	Selection Description
0	No response	The event is ignored.
1	Info	The event is logged in the event log.
10	Fault	The drive issues a fault and coasts the motor.

P 2.2.1.18 Power Limit Generator Delay

Set the delay before the selected response is triggered after the drive has reached the power limit.

Default Value:	–	Parameter Type:	Range (0 — 65000)
Parameter Number:	2365	Unit:	s
Data Type:	REAL	Access Type:	Read/Write

6.3.3.2 Cooling Fan Control (Menu Index 2.2.2)

P 2.2.2.1 Main Fan Minimum Speed

Set the minimum speed of the main cooling fan.

Default Value:	–	Parameter Type:	Range (0 — 100)
Parameter Number:	2932	Unit:	%
Data Type:	REAL	Access Type:	Read/Write

P 2.2.2.2 Internal Fan Minimum Speed

Set the minimum speed of the internal cooling fan.

Default Value:	–	Parameter Type:	Range (0 — 100)
Parameter Number:	2928	Unit:	%
Data Type:	REAL	Access Type:	Read/Write

P 2.2.2.3 Main Fan Fail Response

Select the drive response to a main fan fail.

Default Value:	3 (Warning)	Parameter Type:	Selection
Parameter Number:	2939	Unit:	–
Data Type:	UINT	Access Type:	Read/Write

The following are the selections for the parameter.

Selection Number	Selection Name	Selection Description
3	Warning	The drive issues a warning.
10	Fault	The drive issues a fault and coasts the motor.

P 2.2.2.4 Internal Fan Fail Response

Select the drive response to an internal fan fail.

Default Value:	3 (Warning)	Parameter Type:	Selection
-----------------------	-------------	------------------------	-----------

Parameter Number: 2940	Unit: –
Data Type: UINT	Access Type: Read/Write

The following are the selections for the parameter.

Selection Number	Selection Name	Selection Description
3	Warning	The drive issues a warning.
10	Fault	The drive issues a fault and coasts the motor.

6.3.4 Protection (Menu Index 2.3)

6.3.4.1 Settings (Menu Index 2.3.1)

P 2.3.1.1 Retry after Fault

Enables retry functionality (ride-through) after fault.

Default Value: 1 (Enabled)	Parameter Type: Selection
Parameter Number: 2927	Unit: –
Data Type: BOOL	Access Type: Read/Write

The following are the selections for the parameter.

Selection Number	Selection Name	Selection Description
0	Disabled	Disables the function.
1	Enabled	Enables the function.

This parameter enables the retry functionality (fault ride-through) after 1 of the common power conversion protections has activated. The number of retries or the retrying window depends on the power unit type and rating. The protections that can utilize retry are:

- Output current ground leakage fault
- Output overcurrent faults
- DC-link overvoltage and undervoltage faults
- Brake resistor or switching element short circuit faults

P 2.3.1.2 Smart Derate Mode

Select the level of derating if the nominal operational limits of the drive have been exceeded.

Default Value: 0 (Maximum derating)	Parameter Type: Selection
Parameter Number: 2345	Unit: –
Data Type: UINT	Access Type: Read/Write

The following are the selections for the parameter.

Selection Number	Selection Name	Selection Description
0	Maximum derating	Drive derates as much as possible.
1	Minimum derating	Drive derates as little as possible.

This parameter selects a level for the derating of the switching frequency whenever it is needed. The drive features multiple protection functions that can derate the switching frequency of the drive, to avoid operating conditions that are harmful for the drive. This parameter can be used to influence the degree of derating. The following table shows the descriptions for the selections available for the parameter:

Table 27: Selection Descriptions

Selection Name	Selection Description
Maximum Derating Mode	When switching frequency derating is applied, the drive reduces the switching frequency to the maximum. This depends on the application scenario.
Minimum Derating Mode	When switching frequency derating is applied, the drive reduces the switching frequency to the minimum. This depends on the application scenario.

P 2.3.1.3 DC-link Voltage Ripple Response

Select the mode of excessive DC-link voltage ripple protection.

Default Value:	1 (Fault)	Parameter Type:	Selection
Parameter Number:	2929	Unit:	–
Data Type:	UDINT	Access Type:	Read/Write

The following are the selections for the parameter.

Selection Number	Selection Name	Selection Description
0	Disabled	Disables the protection.
1	Fault	The drive issues a fault if excessive DC-link voltage ripple is detected.

This parameter selects a response for excessive DC-link voltage ripple protection. Excessive voltage ripples are detected when the peak-to-peak amplitude of the DC voltage exceeds the internal limit of the drive for a long period. Both the limit and time depend on the power unit type and rating. The following table shows the descriptions for the selections available for the parameter:

Table 28: Selection Descriptions

Selection Name	Selection Description
Disabled	No action is undertaken when excessive ripple is detected.
Fault	After detecting excessive ripples for a long period, the drive issues a fault and stops.

P 2.3.1.4 DC-link Imbalance Response

Select a response to an imbalance across the DC-link capacitors' voltage.

Default Value:	10 (Fault)	Parameter Type:	Selection
Parameter Number:	2346	Unit:	–
Data Type:	UINT	Access Type:	Read/Write

The following are the selections for the parameter.

Selection Number	Selection Name	Selection Description
3	Warning	The drive issues a warning.
10	Fault	The drive issues a fault and coasts the motor.

P 2.3.1.5 Rectifier Thermal Overload Response

Select the mode of rectifier thermal overload protection.

Default Value:	1 (Fault)	Parameter Type:	Selection
Parameter Number:	2340	Unit:	–
Data Type:	UINT	Access Type:	Read/Write

The following are the selections for the parameter.

Selection Number	Selection Name	Selection Description
1	Fault	The drive issues a fault and stops.
2	Automatically derate	The drive continues operation with derated performance.

This parameter selects a response to the reaction of the drive for rectifier thermal overload protection. Rectifier thermal overload is detected when the drive operates for a long period at a specified rectifier current level. Specific current levels and trip times depend on the power unit type and rating. The following table shows the descriptions for the selections available for the parameter:

Table 29: Selection Descriptions

Selection Name	Selection Description
Fault	The drive issues a fault and stops modulation.
Automatically derate	The drive derates the rectifier current (DC-link current) to mitigate the cause of rectifier thermal overload. When the drive exits from the overload operation window, derating is stopped.

P 2.3.1.6 Inverter Thermal Overload Response

Select the mode of inverter thermal overload protection.

Default Value:	1 (Fault)	Parameter Type:	Selection
Parameter Number:	2341	Unit:	–
Data Type:	UINT	Access Type:	Read/Write

The following are the selections for the parameter.

Selection Number	Selection Name	Selection Description
1	Fault	The drive issues a fault and stops.
2	Automatically derate	The drive continues operation with derated performance.

This parameter selects a response to the reaction of the drive for Inverter Thermal Overload protection. Inverter thermal overload is detected when the drive operates for a long period at a specified output current level. The levels (current and time) depend on the selected output current level. An example is currents exceeding the nominal levels for a longer time (low overload, high overload). The levels can be found in the Design Guide.

The following table shows the descriptions for the selections available for the parameter:

Table 30: Selection Descriptions

Selection Name	Selection Description
Fault	The drive issues a fault and stops.
Automatically derate	The drive derates the rectifier current (DC-link current) to mitigate the cause of rectifier thermal overload. When the drive exits from the overload operation window, derating is stopped.

P 2.3.1.7 Ground Fault 0 Response

Select a response if a high-impedance ground fault occurs.

Default Value:	9 (Fault, ramp to coast)	Parameter Type:	Selection
Parameter Number:	2347	Unit:	–
Data Type:	UINT	Access Type:	Read/Write

The following are the selections for the parameter.

Selection Number	Selection Name	Selection Description
0	No response	The event is ignored.
9	Fault, ramp to coast	Issues a fault, ramps down, and coast.

P 2.3.1.8 Constant Loss Controller

Enables the constant-loss controller. The function maintains a constant temperature in the drive at low-load conditions.

Default Value:	False	Parameter Type:	Range (False — True)
Parameter Number:	2355	Unit:	–
Data Type:	BOOL	Access Type:	Read/Write

6.3.4.2 Overvoltage Protection (Menu Index 2.3.2)

P 2.3.2.1 Overvoltage Control

Enables the DC-link overvoltage controller. It is recommended to disable the overvoltage controller if brake is enabled, or the unit is supplied with a regulated DC.

Default Value:	1 (Enabled)	Parameter Type:	Selection
Parameter Number:	1802	Unit:	–
Data Type:	BOOL	Access Type:	Read/Write

The following are the selections for the parameter.

Selection Number	Selection Name	Selection Description
0	Disabled	Disables the function.
1	Enabled	Enables the function.

Table 31: Selection Descriptions

Selection name	Selection description
Disable	<ul style="list-style-type: none"> The overvoltage controller does not affect motor speed in any manner. DC-link voltage is controlled with a brake chopper. <div style="border: 1px solid black; padding: 5px; margin-top: 10px;">  NOTE: A DC-link overvoltage fault is usually triggered when the DC-link voltage exceeds acceptable levels. </div>
Enable	When the DC-link voltage level exceeds the overvoltage level, motor speed or deceleration is limited by the controller. The overvoltage voltage level is set with parameter 2.3.2.5 Overvoltage Control Upper Limit .

P 2.3.2.2 Overvoltage Control Kp

Set the scaling of the overvoltage control proportional gain.

Default Value:	100	Parameter Type:	Range (0 — 10000)
Parameter Number:	1803	Unit:	%
Data Type:	REAL	Access Type:	Read/Write

P 2.3.2.3 Overvoltage Control Ti

Set the scaling of the overvoltage control integral time.

Default Value:	100	Parameter Type:	Range (0 — 10000)
Parameter Number:	1804	Unit:	%
Data Type:	REAL	Access Type:	Read/Write

P 2.3.2.4 Overvoltage Control Td

Set the scaling of the overvoltage control derivation time.

Default Value:	100	Parameter Type:	Range (0 — 10000)
Parameter Number:	1805	Unit:	%
Data Type:	REAL	Access Type:	Read/Write

P 2.3.2.5 Overvoltage Control Upper limit

Set the upper limit for the overvoltage control. However, the voltage can be limited internally by the drive because of the available hardware, temperature, and time.

Default Value:	796.5	Parameter Type:	Range (* — *)
Parameter Number:	1816	Unit:	V
Data Type:	REAL	Access Type:	Read/Write

6.3.4.3 Power Loss (Menu Index 2.3.3)

P 2.3.3.3 Power Loss Response

Select the response to an insufficient supply voltage.

Default Value:	1 (Undervoltage control)	Parameter Type:	Selection
-----------------------	--------------------------	------------------------	-----------

Parameter Number: 1818	Unit: –
Data Type: UINT	Access Type: Read/Conditional Write

The following are the selections for the parameter.

Selection Number	Selection Name	Selection Description
0	None	The function is disabled.
1	Undervoltage control	Drive utilizes the kinetic energy in the system to maintain operation as long as possible.
2	Controlled ramp down	Drive utilizes the kinetic energy in the system to perform a controlled ramp down.
3	Coast	Drive coasts the motor.

This parameter sets the reaction of the drive when the drive has insufficient supply voltage (DC-link voltage). Insufficient voltage is detected when the actual voltage falls below the undervoltage limit.

Table 32: Selection Descriptions

Selection name	Selection description
None	During a power loss scenario, the drive takes no action. The undervoltage controlled is disabled.
Undervoltage control	<ul style="list-style-type: none"> When the voltage falls below the undervoltage level, the undervoltage controller is activated. The controller decelerates the motor speed to regenerate energy to DC-link. Use this selection for system module drives.
Controlled ramp down	When the voltage falls below the undervoltage level, the drive stops by ramping the motor speed to zero before stopping modulation.
Coast	When the voltage falls below the undervoltage level, the drive immediately stops modulating.

P 2.3.3.4 Power Recovery Response

Select the action to take when supply voltage returns after a power loss.

Default Value: 0 (Ramp to reference)	Parameter Type: Selection
Parameter Number: 1819	Unit: –
Data Type: UINT	Access Type: Read/Conditional Write

The following are the selections for the parameter.

Selection Number	Selection Name	Selection Description
0	Ramp to reference	Drive ramps to reference.
1	Ramp fast to reference	Drive ramps as fast as possible to reference.
2	Ramp to zero	Drive ramps down and coasts.

Sets the reaction of the drive when the supply voltage (DC-link voltage) returns after a power loss event. The reaction occurs when the actual voltage returns and exceeds the undervoltage limit.

Table 33: Selection Descriptions

Selection name	Selection description
Ramp to reference	This is the recommended selection for a system drive. The drive ramps from the actual speed to the reference.
Ramp fast to reference	The drive bypasses ramping and operates directly with the reference.  NOTE: This selection is only available with the flux motor control principle.
Ramp to zero	The drive ramps from the actual speed to zero and coasts.

P 2.3.3.5 Undervoltage Control Kp

Set the scaling of the undervoltage control proportional gain.

Default Value:	100	Parameter Type:	Range (0.001 — 10000)
Parameter Number:	1806	Unit:	%
Data Type:	REAL	Access Type:	Read/Write

P 2.3.3.6 Undervoltage Control Ti

Set the scaling of the undervoltage control integral time.

Default Value:	100	Parameter Type:	Range (0 — 10000)
Parameter Number:	1807	Unit:	%
Data Type:	REAL	Access Type:	Read/Write

P 2.3.3.7 Undervoltage Control Td

Set the scaling of the undervoltage control derivation time.

Default Value:	100	Parameter Type:	Range (0 — 10000)
Parameter Number:	1808	Unit:	%
Data Type:	REAL	Access Type:	Read/Write

P 2.3.3.8 Undervoltage Control Activation Level

Set the level at which undervoltage control is activated.

Default Value:	100	Parameter Type:	Range (* — *)
Parameter Number:	1817	Unit:	V
Data Type:	REAL	Access Type:	Read/Write

P 2.3.3.12 Deceleration Time Power Loss

Set the deceleration time from nominal speed to 0 when in power-loss mode.

Default Value:	0.5	Parameter Type:	Range (0.02 — 10000)
Parameter Number:	1139	Unit:	s
Data Type:	REAL	Access Type:	Read/Write

6.3.5 Modulation (Menu Index 2.4)

P 2.4.1 Max. Switching Frequency

Set the maximum switching frequency.

Default Value:	16.00	Parameter Type:	Range (* — *)
Parameter Number:	2924	Unit:	kHz
Data Type:	REAL	Access Type:	Read/Write

P 2.4.2 Min. Switching Frequency

Set the minimum switching frequency.

Default Value:	1.00	Parameter Type:	Range (* — *)
Parameter Number:	2925	Unit:	kHz
Data Type:	REAL	Access Type:	Read/Write

P 2.4.3 Switching Frequency

Set the switching frequency.

Default Value:	1.00	Parameter Type:	Range (* — *)
Parameter Number:	2920	Unit:	kHz
Data Type:	REAL	Access Type:	Read/Write

P 2.4.4 Control Frequency Request

Set the requested control frequency. A constant control frequency is enabled by setting this value. If set to 0.0, constant control frequency is disabled.

Default Value:	–	Parameter Type:	Range (0.00 — *)
Parameter Number:	2921	Unit:	kHz
Data Type:	REAL	Access Type:	Read/Conditional Write

P 2.4.6 Overmodulation

Enables the modulation index to exceed 1.0.

Default Value:	1 (Enabled)	Parameter Type:	Selection
Parameter Number:	5094	Unit:	–
Data Type:	BOOL	Access Type:	Read/Write

The following are the selections for the parameter.

Selection Number	Selection Name	Selection Description
0	Disabled	Disables the function.
1	Enabled	Enables the function.

6.4 Filters & Brake Chopper (Menu Index 3)

6.4.1 Filters & Brake Chopper Overview

This parameter group contains parameters for configuring, monitoring, and controlling the input filters, output filters, brake chopper, and brake resistors.

6.4.2 Filters & Brake Chopper Status (Menu Index 3.1)

P 3.1.1 Brake Power

Shows the power dissipated in the brake resistor.

Default Value:	NA	Parameter Type:	Range (0.00 — *)
Parameter Number:	2933	Unit:	kW
Data Type:	REAL	Access Type:	Read Only

P 3.1.2 Average Brake Power

Shows the average power dissipated in the brake resistor, calculated over 120 s.

Default Value:	NA	Parameter Type:	Range (0.00 — *)
Parameter Number:	2934	Unit:	kW
Data Type:	REAL	Access Type:	Read Only

P 3.1.3 AHF Capacitor Connected

Shows if the advanced harmonic filter (AHF) capacitor is connected.

Default Value:	NA	Parameter Type:	Range (False — True)
Parameter Number:	5410	Unit:	–
Data Type:	BOOL	Access Type:	Read Only

6.4.3 Brake Chopper (Menu Index 3.2)

P 3.2.1 Brake Chopper

Select the brake chopper operation mode.

Default Value:	0 (Disabled)	Parameter Type:	Selection
Parameter Number:	2935	Unit:	–
Data Type:	UINT	Access Type:	Read/Write

The following are the selections for the parameter.

Selection Number	Selection Name	Selection Description
0	Disabled	
1	Enabled in Run and Coast	Enables the brake chopper both while running and at coast.
2	Enabled in run only	Enables the brake chopper while running.

P 3.2.2 Brake Chopper Voltage Reduce

Set the activation level of the brake chopper. If set to 0, the brake chopper is active if the voltage exceeds the overvoltage control activation level. The value set is subtracted from the overvoltage control activation level, lowering the brake chopper activation level, respectively.

Default Value:	–	Parameter Type:	Range (0 — 50)
Parameter Number:	2938	Unit:	V
Data Type:	REAL	Access Type:	Read/Write

6.4.4 Brake Resistor (Menu Index 3.3)

P 3.3.1 Brake Resistor Test

Enables the brake resistor test. The drive conducts a test of brake resistor presence while the drive is coasted. Starting of the drive is prohibited until the test is completed.

Default Value:	NA	Parameter Type:	Selection
Parameter Number:	430	Unit:	–
Data Type:	UINT	Access Type:	Read/Conditional Write

The following are the selections for the parameter.

Selection Number	Selection Name	Selection Description
0	Off	
1	Enable brake chopper test run	Executes a test of the brake chopper and brake resistor to check if they are operational.

P 3.3.2 Brake Resistor Resistance

Set the resistance value of the brake resistor.

Default Value:	5	Parameter Type:	Range (* — *)
Parameter Number:	2936	Unit:	Ω
Data Type:	REAL	Access Type:	Read/Conditional Write

P 3.3.3 Brake Resistor Power Limit

Set the power limit for resistor braking.

Default Value:	1	Parameter Type:	Range (0 — *)
Parameter Number:	2937	Unit:	kW
Data Type:	REAL	Access Type:	Read/Write

The parameter must be configured to set the expected average power dissipated in the brake resistor over a period of 120 s. To calculate the brake resistor power limit, use the following formula.

$$P_{br,avg}(W) = \frac{U_{br}^2 \times t_{br}(s)}{R_{br}(\Omega) \times T_{br}(s)}$$

The following elements are used in the formula:

- $P_{br,avg}$ is the average power dissipated in the brake resistor.

- R_{br} is the resistance of the brake resistor.
- t_{br} is the active breaking time within 120 s. (T_{br}).
- U_{br} is the DC link when the brake chopper is active. The correct value depends on the selection of parameter **2.2.1 Unit Voltage Class** using the following table.

Table 34: Power rating and voltage class setting

Voltage range	Unit voltage class 380–500 V AC (3N05)
Low voltage range	705
Medium voltage range	770
High voltage range (low brake level)	780
High voltage range (high brake level)	800

6.4.5 Advanced Harmonic Filter (Menu Index 3.4)

P 3.4.1 Advanced Harmonic Filter

Select if the Advanced Harmonic Filter is connected to the drive.

Default Value:	False	Parameter Type:	Selection
Parameter Number:	3410	Unit:	–
Data Type:	BOOL	Access Type:	Read/Write

The following are the selections for the parameter.

Selection Number	Selection Name	Selection Description
0	Disabled	Disables the function.
1	Enabled	Enables the function.

P 3.4.2 Capacitor Disconnect Output

Select the output terminal for disconnecting the capacitor.

Default Value:	–	Parameter Type:	Selection
Parameter Number:	3412	Unit:	–
Data Type:	UINT	Access Type:	Read/Write

P 3.4.3 Thermal Switch Response

Select which function is activated if the thermal input indicates too high a temperature.

Default Value:	1 (Fault, ramp to coast)	Parameter Type:	Selection
Parameter Number:	3413	Unit:	–
Data Type:	UINT	Access Type:	Read/Write

The following are the selections for the parameter.

Selection Number	Selection Name	Selection Description
1	Fault, ramp to coast	Issues a fault, ramps down, and coast.
2	Derate	The drive issues a fault, continues operation, and derates to protect the filter.

P 3.4.4 Thermal Switch Input

Select the digital input terminal for the thermal switch.

Default Value:	–	Parameter Type:	Selection
Parameter Number:	3414	Unit:	–
Data Type:	UINT	Access Type:	Read/Write

P 3.4.5 Power Stabilizer Gain

Set the controller gain for power stabilization. The power stabilizer dampens possible resonance with the grid. If set to -1 the value is selected automatically, if set to 0 the controller is disabled.

Default Value:	-1	Parameter Type:	Range (-1 — 500)
Parameter Number:	3415	Unit:	%
Data Type:	REAL	Access Type:	Read/Write

P 3.4.6 Power Stabilizer Bandwidth

Set the controller bandwidth for power stabilization.

Default Value:	100	Parameter Type:	Range (1 — 10000)
Parameter Number:	3416	Unit:	%
Data Type:	REAL	Access Type:	Read/Write

6.4.6 Output Filter (Menu Index 3.5)

P 3.5.1 Output Filter Type

Select the output filter type.

Default Value:	0 (None)	Parameter Type:	Selection
Parameter Number:	5501	Unit:	–
Data Type:	UINT	Access Type:	Read/Conditional Write

The following are the selections for the parameter.

Selection Number	Selection Name	Selection Description
0	None	No output filter connected.
1	Sine-wave Filter	Sine-wave filter connected.

P 3.5.2 Filter Capacitance

Set the capacitance of the output filter.

Default Value:	*	Parameter Type:	Range (0.00 — 1000000.00)
Parameter Number:	5502	Unit:	μF
Data Type:	REAL	Access Type:	Read/Conditional Write

Set the Cy (capacitance) value of the output filter. See the filter product label for the capacitance value. The value is the equivalent star-connected capacitance of the filter. When the filters are installed in parallel, enter the combined capacitance value of the paralleled filter. The value is the equivalent star-connected capacitance (Cy) of the filter multiplied by the number of installed paralleled filters.

P 3.5.3 Filter Inductance

Set the inductance of the output filter.

Default Value:	*	Parameter Type:	Range (0.00 — 1000.00)
Parameter Number:	5503	Unit:	mH
Data Type:	REAL	Access Type:	Read/Conditional Write

Set the inductance of the output filter. See the product label of the filter for the value of inductance. When filters are installed in parallel, enter the combined inductance value of the installed paralleled filters. The inductance value in the parameter is the inductance value of the filter divided by the number of paralleled filters.

P 3.5.4 Filter series resistance

Set the equivalent resistance for the inductance of the output filter.

Default Value:	*	Parameter Type:	Range (0 — 1000000)
Parameter Number:	5499	Unit:	Ω
Data Type:	REAL	Access Type:	Read/Conditional Write

6.5 Motor (Menu Index 4)

6.5.1 Motor Overview

This parameter group contains parameters for configuring the motor, motor control, and motor protection.

6.5.2 Motor Status (Menu Index 4.1)

P 4.1.1 Motor Current

Shows the actual motor current.

Default Value:	NA	Parameter Type:	Range (0 — *)
Parameter Number:	9000	Unit:	A
Data Type:	REAL	Access Type:	Read Only

P 4.1.2 Relative Motor Current

Shows the actual motor current in % of the nominal motor current.

Default Value:	NA	Parameter Type:	Range (0 — 200)
Parameter Number:	9001	Unit:	%
Data Type:	REAL	Access Type:	Read Only

P 4.1.3 U-phase RMS Current

Shows the U-phase RMS current.

Default Value:	NA	Parameter Type:	Range (0 — *)
Parameter Number:	9020	Unit:	A
Data Type:	REAL	Access Type:	Read Only

P 4.1.4 V-phase RMS Current

Shows the V-phase RMS current.

Default Value:	NA	Parameter Type:	Range (0 — *)
Parameter Number:	9021	Unit:	A
Data Type:	REAL	Access Type:	Read Only

P 4.1.5 W-phase RMS Current

Shows the W-phase RMS current.

Default Value:	NA	Parameter Type:	Range (0 — *)
Parameter Number:	9022	Unit:	A
Data Type:	REAL	Access Type:	Read Only

P 4.1.6 Motor Voltage

Shows the actual motor voltage.

Default Value:	NA	Parameter Type:	Range (0 — *)
Parameter Number:	9005	Unit:	V
Data Type:	REAL	Access Type:	Read Only

P 4.1.7 Relative Motor Voltage

Shows the actual motor voltage in % of the nominal motor voltage.

Default Value:	NA	Parameter Type:	Range (0 — 200)
Parameter Number:	9006	Unit:	%
Data Type:	REAL	Access Type:	Read Only

P 4.1.11 Motor Torque

Shows the actual motor torque.

Default Value:	NA	Parameter Type:	Range (-10000000 — 10000000)
Parameter Number:	9009	Unit:	Nm
Data Type:	REAL	Access Type:	Read Only

P 4.1.12 Relative Motor Torque

Shows the motor torque in % of the nominal motor torque.

Default Value:	NA	Parameter Type:	Range (* — *)
----------------	----	-----------------	-----------------

Parameter Number:	1708	Unit:	%
Data Type:	REAL	Access Type:	Read Only

P 4.1.13 Motor Shaft Power

Shows the actual power at the motor shaft.

Default Value:	NA	Parameter Type:	Range (* — *)
Parameter Number:	9008	Unit:	kW
Data Type:	REAL	Access Type:	Read Only

P 4.1.14 Relative Motor Shaft Power

Shows the actual motor shaft power in % of the nominal motor shaft power.

Default Value:	NA	Parameter Type:	Range (-300 — 300)
Parameter Number:	1707	Unit:	%
Data Type:	REAL	Access Type:	Read Only

P 4.1.15 Motor Electrical Power

Shows the actual motor power.

Default Value:	NA	Parameter Type:	Range (* — *)
Parameter Number:	9043	Unit:	kW
Data Type:	REAL	Access Type:	Read Only

P 4.1.16 Motor Thermal Load (ETR)

Shows the estimated thermal load of the motor calculated by the ETR function.

Default Value:	NA	Parameter Type:	Range (0 — 100)
Parameter Number:	2951	Unit:	%
Data Type:	REAL	Access Type:	Read Only

P 4.1.17 Motor Current Output

Select an output for the motor current signal. The scale of the signal is 0–100% of the nominal current.

Default Value:	–	Parameter Type:	Selection
Parameter Number:	2302	Unit:	–
Data Type:	UINT	Access Type:	Read/Write

P 4.1.18 Motor Voltage Output

Select an output for the motor voltage signal. The scale of the signal is 0–100% of the nominal voltage.

Default Value:	–	Parameter Type:	Selection
Parameter Number:	2303	Unit:	–
Data Type:	UINT	Access Type:	Read/Write

P 4.1.19 Absolute Motor Torque Output

Select an output for the motor torque signal. The scale of the signal is 0–100% of the absolute value of the nominal torque.

Default Value:	–	Parameter Type:	Selection
Parameter Number:	2306	Unit:	–
Data Type:	UINT	Access Type:	Read/Write

P 4.1.20 Extended Motor Torque Output

Select an output for the motor torque signal. The scale of the signal is -200...200% of the nominal torque.

Default Value:	–	Parameter Type:	Selection
Parameter Number:	2310	Unit:	–
Data Type:	UINT	Access Type:	Read/Write

P 4.1.21 Absolute Motor Speed Output

Select an output for the motor speed signal. The scale of the signal is 0–100% of the absolute value of the nominal speed.

Default Value:	–	Parameter Type:	Selection
Parameter Number:	2301	Unit:	–
Data Type:	UINT	Access Type:	Read/Write

P 4.1.22 Extended Motor Speed Output

Select an output for the motor speed signal. The scale of the signal is -200...200% of the nominal speed.

Default Value:	–	Parameter Type:	Selection
Parameter Number:	2309	Unit:	–
Data Type:	UINT	Access Type:	Read/Write

P 4.1.23 Motor Power Output

Select an output for the motor power signal. The scale of the signal is 0–100% of the nominal power.

Default Value:	–	Parameter Type:	Selection
Parameter Number:	2305	Unit:	–
Data Type:	UINT	Access Type:	Read/Write

P 4.1.24 AMA Progress

Shows the progress of the Automatic Motor Adaptation (AMA).

Default Value:	NA	Parameter Type:	Range (0 — 100)
Parameter Number:	429	Unit:	%
Data Type:	REAL	Access Type:	Read Only

P 4.1.26 Motor Temperature

The analog temperature sensor has exceeded the configured value.

Default Value:	NA	Parameter Type:	Range (-300 — 300)
----------------	----	-----------------	--------------------

Parameter Number: 1630	Unit: °C
Data Type: REAL	Access Type: Read Only

P 4.1.28 Rs Measured

When a Rs measurement is stored for use after drive power recycle, the value is shown here; otherwise it is zero.

Default Value: NA	Parameter Type: Range (0 — 100000)
Parameter Number: 433	Unit: Ω
Data Type: REAL	Access Type: Read Only

6.5.3 Motor Data (Menu Index 4.2)

6.5.3.1 General Settings (Menu Index 4.2.1)

P 4.2.1.1 Motor Type

Select the motor type.

Default Value: 0 (Induction Motor)	Parameter Type: Selection
Parameter Number: 407	Unit: –
Data Type: UINT	Access Type: Read/Conditional Write

The following are the selections for the parameter.

Selection Number	Selection Name	Selection Description
0	Induction Motor	Asynchronous Induction Motor.
1	Permanent Magnet Motor	Permanent Magnet Motor.

P 4.2.1.2 Number of Pole Pairs

Set the number of pole pairs. For example, a 4-pole motor is set as 2 pole pairs.

Default Value: 2	Parameter Type: Range (0 — 65535)
Parameter Number: 406	Unit: –
Data Type: UINT	Access Type: Read/Conditional Write

The synchronous speed of a motor can be calculated when the supply frequency and number of pole pairs are known. The formula to calculate the synchronous speed of the motor (n_s) with supply frequency (f) and number of pole pairs (p) is as follows:

$$n_s = \frac{60 \times f}{p} \text{ [RPM]}$$

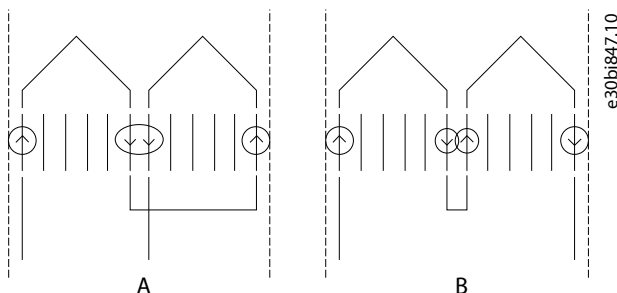

Figure 60: Two Inductors in 1 Phase Connected in Series to A) 2 Poles B) 4 Poles

While the frequency is determined by the grid or the AC drive, the number of poles is determined by the way the stator inductors are connected. Pole pairs (p) or pole number and synchronous motor speed lists the number of poles corresponding to synchronous speed (n0) at 50 Hz and 60 Hz supply.

Table 35: Number of Pole Pairs (p) and Nominal Speed (~nn) for Motors @ 50 Hz and 60 Hz

Number of pole pairs (p)	~nn @ 50 Hz	~nn @ 60 Hz
1	2700–2880	3250–3460
2	1350–1450	1625–1730
3	700–960	840–1153

Table 36: Pole Pairs (p) or Pole Number and Synchronous Motor Speed

Number of pole pairs (p)	1	2	3	4	6
Number of poles	2	4	6	8	12
50 Hz supply	3000	1500	1000	750	500
60 Hz supply	3600	1800	1200	900	600

The dependency of the motor's synchronous speed n_s in RPM of the frequency f of the power supply in Hz (parameter **1.1.1 Grid Frequency**) and the number of pole pairs in parameter **4.2.1.2 Number of Pole Pairs** is provided by the earlier formula.

For example, for a motor with 2 pole pairs (4 poles) and a frequency of the power supply of 50 Hz, the synchronous speed of the motor is:

$$n_s = \frac{60 \times f}{p} \text{ [RPM]} = 1500 \text{ RPM}$$

P 4.2.1.3 AMA Mode

Select the Automatic Motor Adaptation (AMA) mode.

Default Value:	0 (Off)	Parameter Type:	Selection
Parameter Number:	420	Unit:	–
Data Type:	UINT	Access Type:	Read/Conditional Write

The following are the selections for the parameter.

Selection Number	Selection Name	Selection Description
0	Off	AMA is disabled for normal operation.
3	Motor Data	The next start command initiates measurement of the motor data.
4	Reduced Motor Data (Rs)	The next start command initiates measurement of the motor stator resistance - Rs.

Automatic Motor Adaptation (AMA) is an automated test procedure providing an optimization of the motor parameters for improved shaft performance. The measurement is performed based on the motor product label data in parameter group **4.2.2 Motor Nameplate Data**. The motor-type-specific parameters in parameter group **4.2.3 Induction Motor** or parameter group **4.2.4 Permanent Magnet Motor** are recalculated and used to fine-tune the motor control algorithm. Running the AMA procedure also maximizes the automatic energy optimization (AEO) feature of the drive. AMA also allows the automatic detection of the motor type based on the product label data.

- The AMA must be run on a cold motor. Running the AMA multiple times also increases the motor temperature.
- The AMA must be conducted with the motor at standstill.

- Avoid generating external torque during AMA.
- The AMA cannot run with a sine-wave filter connected.
- Uncoupling the load from the motor is not needed.
- The duration of the AMA depends on the power rating of the motor.
- Changing the product label data in parameter group **4.2.2 Motor Nameplate Data** also modifies the data in the parameter group **4.2.3 Induction Motor** or **4.2.4 Permanent Magnet Motor**.



NOTE: The parameter automatically switches back to Off after the AMA has been performed.

P 4.2.1.4 Rs Measurement at start

Determine when a Rs measurement is performed.

Default Value:	0 (Off)	Parameter Type:	Selection
Parameter Number:	432	Unit:	–
Data Type:	UINT	Access Type:	Read/Write

The following are the selections for the parameter.

Selection Number	Selection Name	Selection Description
0	Off	Select this setting to disable Rs measurement. To reset the triggering, this setting must be selected in between the other methods.
1	First start after power on	Select performing a Rs measurement at the first start after the drive is powered on.
2	Every start	A Rs measurement is performed before every start.
3	First start with store	Enable performing a Rs measurement at the first start. The measurement is stored.

Use Rs measurement at start to measure the resistance of the stator (Rs) before motor start, for induction and permanent magnet motors running FVC+. For induction motors, the rotor resistance (Rr) is also provided.

Accurate motor parameters are important for optimum motor performance, and measuring resistances before starting the motor can help compensate for variation caused by changes in motor operating temperature.

It is important that the shaft is not rotating when the measurement is made. If it cannot be guaranteed, use DC hold to stop the shaft before start.

P 4.2.1.5 Motor Cable Length

Set the motor cable length.

Default Value:	100	Parameter Type:	Range (0 — 10000)
Parameter Number:	425	Unit:	m
Data Type:	REAL	Access Type:	Read/Conditional Write

In some products, depending on the EMC configuration, this parameter may adjust the allowable switching frequency automatically to achieve optimum performance of the drive system.

Depending on whether metric or imperial units are in use, give the value for the parameter in either meters (m) or feet (ft). The value range is different with the different units.

P 4.2.1.6 Output Phase Sequence

Set the output phase sequence. This function virtually swaps the output phases, which can be used to change the direction of motor rotation without having to physically rewire motor cables.

Default Value:	0 (UVW)	Parameter Type:	Selection
Parameter Number:	431	Unit:	–
Data Type:	UINT	Access Type:	Read/Conditional Write

The following are the selections for the parameter.

Selection Number	Selection Name	Selection Description
0	UVW	Select the normal phase sequence.
1	WVU	Select the reverse phase sequence.

6.5.3.2 Motor Nameplate Data (Menu Index 4.2.2)

These parameters allow the setting of motor nameplate data.

Often, permanent magnet motors have torque but not power given on the motor nameplate. For those motors, set the speed and torque product label settings, then the system calculates the power value. The system also calculates the torque value for asynchronous motors, when the power and speed values are set.

When a higher priority parameter is set, the value of the lower priority parameter is calculated by the system. The parameters have the following priority order:

1. Nominal Power
2. Nominal Speed
3. Nominal Torque

To calculate the nominal torque of the motor, first set nominal power and then nominal speed.

To calculate nominal power of the motor, first set nominal speed and then nominal torque.

P 4.2.2.1 Nominal Power

Set the nominal motor shaft power.

Default Value:	5.50	Parameter Type:	Range (* — *)
Parameter Number:	405	Unit:	kW
Data Type:	REAL	Access Type:	Read/Conditional Write

P 4.2.2.2 Nominal Current

Set the nominal motor current.

Default Value:	11.5	Parameter Type:	Range (* — *)
Parameter Number:	400	Unit:	A
Data Type:	REAL	Access Type:	Read/Conditional Write

P 4.2.2.3 Nominal Speed

Set the nominal motor shaft speed.

Default Value:	1450	Parameter Type:	Range (0 — 100000)
Parameter Number:	402	Unit:	rpm
Data Type:	REAL	Access Type:	Read/Conditional Write

P 4.2.2.4 Nominal Frequency

Set the nominal motor frequency.

Default Value:	50	Parameter Type:	Range (0 — 2000)
Parameter Number:	403	Unit:	Hz
Data Type:	REAL	Access Type:	Read/Conditional Write

P 4.2.2.5 Nominal Voltage

Set the nominal motor voltage.

Default Value:	400	Parameter Type:	Range (* — *)
Parameter Number:	401	Unit:	V
Data Type:	REAL	Access Type:	Read/Conditional Write

P 4.2.2.6 Nominal Torque

Set the nominal torque from the nameplate of the motor.

Default Value:	52521.13	Parameter Type:	Range (* — *)
Parameter Number:	9951	Unit:	NomTorqueSI
Data Type:	REAL	Access Type:	Read/Conditional Write

6.5.3.3 Induction Motor (Menu Index 4.2.3)

P 4.2.3.1 Stator Resistance Rs

Set the motor stator resistance. Overwritten by AMA.

Default Value:	1.21	Parameter Type:	Range (0 — 1000000)
Parameter Number:	408	Unit:	Ω
Data Type:	REAL	Access Type:	Read/Conditional Write

P 4.2.3.2 Rotor Resistance Rr

Set the motor rotor resistance. Overwritten by AMA.

Default Value:	0.79	Parameter Type:	Range (0 — 1000000)
Parameter Number:	409	Unit:	Ω
Data Type:	REAL	Access Type:	Read/Conditional Write

Use any of the following methods for setting Rr:

- Run an AMA on a cold motor. The drive measures the value from the motor. All compensations are reset to 100%.
- Enter the Rr value manually. Obtain the value from the motor supplier.
- Use the Rr default setting. The drive establishes the setting based on the motor nameplate data.

P 4.2.3.3 Iron Loss Resistance Rfe

Set the motor iron-loss equivalent resistance.

Default Value:	874	Parameter Type:	Range (0 — 11000000000)
Parameter Number:	413	Unit:	Ω
Data Type:	REAL	Access Type:	Read/Conditional Write

The Rfe value cannot be found by performing an AMA. The Rfe value is especially important in torque control applications. If Rfe is unknown, make sure to keep the default setting of the parameter.

P 4.2.3.4 Stator Leakage Reactance Xls

Set the motor stator leakage reactance. Overwritten by AMA.

Default Value:	0.03	Parameter Type:	Range (0.00 — 62.83)
Parameter Number:	440	Unit:	Ω
Data Type:	REAL	Access Type:	Read/Conditional Write

Use any of the following methods for setting Xls:

- Run an AMA on a cold motor. The drive measures the value from the motor.
- Enter the Xls value manually. Obtain the value from the motor supplier.
- Use the Xls default setting. The drive establishes the setting based on the motor nameplate data.

P 4.2.3.5 Rotor Leakage Reactance Xlr

Set the motor rotor leakage reactance. Overwritten by AMA.

Default Value:	0.03	Parameter Type:	Range (0.00 — 62.83)
Parameter Number:	441	Unit:	Ω
Data Type:	REAL	Access Type:	Read/Conditional Write

Use any of the following methods to set Xlr:

- Run an AMA on a cold motor. The drive measures the value from the motor.
- Enter the Xlr value manually. Obtain the value from the motor supplier.
- Use the Xlr default setting. The drive establishes the setting based on the motor nameplate data.

P 4.2.3.6 Magnetizing Reactance Xm

Set the motor magnetizing reactance. Overwritten by AMA.

Default Value:	0.94	Parameter Type:	Range (0.00 — 62.83)
Parameter Number:	442	Unit:	Ω
Data Type:	REAL	Access Type:	Read/Conditional Write

6.5.3.4 Permanent Magnet Motor (Menu Index 4.2.4)

P 4.2.4.1 Back EMF

Set the stator nominal induced voltage (back-EMF voltage) when running at 1000 RPM (line-to-line RMS). Overwritten by AMA.

Default Value:	190	Parameter Type:	Range (0 — 10000)
Parameter Number:	415	Unit:	V

Data Type:	REAL	Access Type:	Read/Conditional Write
-------------------	------	---------------------	------------------------

P 4.2.4.2 Stator Resistance Rs

Set the motor stator resistance. Overwritten by AMA.

Default Value:	1.21	Parameter Type:	Range (0 — 1000000)
Parameter Number:	408	Unit:	Ω
Data Type:	REAL	Access Type:	Read/Conditional Write

P 4.2.4.3 d-axis Inductance Ld

Set the motor non-saturated d-axis inductance. Overwritten by AMA.

Default Value:	23.00	Parameter Type:	Range (0.00 — 1000.00)
Parameter Number:	417	Unit:	mH
Data Type:	REAL	Access Type:	Read/Conditional Write

P 4.2.4.4 d-axis Inductance Ld-Sat

Set the motor saturated d-axis inductance. Overwritten by AMA.

Default Value:	23.00	Parameter Type:	Range (0.00 — 1000.00)
Parameter Number:	418	Unit:	mH
Data Type:	REAL	Access Type:	Read/Conditional Write

P 4.2.4.5 Ld Saturation Point

Set the point (in % of nominal motor current) at which the Ld inductance saturates (average of non-saturated and saturated).
Overwritten by AMA.

Default Value:	100	Parameter Type:	Range (0 — 300)
Parameter Number:	426	Unit:	%
Data Type:	REAL	Access Type:	Read/Conditional Write

P 4.2.4.6 q-axis Inductance Lq

Set the motor non-saturated q-axis inductance. Overwritten by AMA.

Default Value:	85.00	Parameter Type:	Range (0.00 — 1000.00)
Parameter Number:	427	Unit:	mH
Data Type:	REAL	Access Type:	Read/Conditional Write

P 4.2.4.7 q-axis Inductance Lq-Sat

Set the motor saturated q-axis inductance. Overwritten by AMA.

Default Value:	85.00	Parameter Type:	Range (0.00 — 1000.00)
Parameter Number:	422	Unit:	mH
Data Type:	REAL	Access Type:	Read/Conditional Write

P 4.2.4.8 Lq Saturation Point

Set the point (in % of nominal motor current) at which the Lq inductance saturates (average of non-saturated and saturated). Overwritten by AMA.

Default Value:	100	Parameter Type:	Range (0 — 300)
Parameter Number:	424	Unit:	%
Data Type:	REAL	Access Type:	Read/Conditional Write

6.5.4 Motor Control (Menu Index 4.3)

6.5.4.1 General Settings (Menu Index 4.3.1)

P 4.3.1.1 Motor Control Principle

Select the motor control principle.

Default Value:	1 (VVC+ Control)	Parameter Type:	Selection
Parameter Number:	2503	Unit:	–
Data Type:	UINT	Access Type:	Read/Conditional Write

The following are the selections for the parameter.

Selection Number	Selection Name	Selection Description
0	U/f Control	Selects U/f control as motor control.
1	VVC+ Control	Selects Voltage Vector Control (VVC+) as motor control.
2	FVC+ Control	Selects Flux Vector Control (FVC+) as motor control.

P 4.3.1.2 Breakaway Current Boost

Enables the breakaway current boost, which temporarily allows a higher starting current.

Default Value:	False	Parameter Type:	Selection
Parameter Number:	2930	Unit:	–
Data Type:	BOOL	Access Type:	Read/Write

The following are the selections for the parameter.

Selection Number	Selection Name	Selection Description
0	Disabled	Disables the function.
1	Enabled	Enables the function.

P 4.3.1.5 Motor Feedback Mode

Select the feedback mode.

Default Value:	0 (Open loop)	Parameter Type:	Selection
Parameter Number:	2502	Unit:	–
Data Type:	UINT	Access Type:	Read/Write

The following are the selections for the parameter.

Selection Number	Selection Name	Selection Description
0	Open loop	The motor is operated without feedback. The motor control estimates the actual speed.
1	Closed loop with Feedback Device 1	The motor is operated with feedback, providing speed and position feedback for motor control from feedback device 1.
2	Closed loop with Feedback Device 2	The motor is operated with feedback, providing speed and position feedback for motor control from feedback device 2.

P 4.3.1.6 Motor Feedback Test Mode

Select the motor feedback test mode.

Default Value:	0 (Off)	Parameter Type:	Selection
Parameter Number:	421	Unit:	–
Data Type:	UINT	Access Type:	Read/Conditional Write

The following are the selections for the parameter.

Selection Number	Selection Name	Selection Description
0	Off	Motor feedback test is not enabled.
1	Enable Motor Feedback Test	The next start command initiates a test of the motor feedback signal.

P 4.3.1.9 Maximum Motor Voltage

Set the maximum output voltage applied to the motor. This can be used to avoid a field-weakening operation when running at speeds above the nominal motor speed, when the drive is supplied with a voltage higher than the nominal motor voltage.

Default Value:	400	Parameter Type:	Range (0 — 1000)
Parameter Number:	5433	Unit:	V
Data Type:	REAL	Access Type:	Read/Write

P 4.3.1.10 Motor Voltage Limitation Mode

Motor voltage limitation mode selection. The limitation is performed based on the DC-link voltage.

Default Value:	0 (Average DC-link voltage)	Parameter Type:	Selection
Parameter Number:	4620	Unit:	–
Data Type:	UINT	Access Type:	Read/Write

The following are the selections for the parameter.

Selection Number	Selection Name	Selection Description
0	Average DC-link voltage	Motor voltage is limited based on the average DC-link voltage.
1	Minimum DC-link voltage	Motor voltage is limited based on the minimum DC-link voltage.

6.5.4.2 Running a Motor Feedback Test

The Motor Feedback Test optimizes closed-loop motor operation. During the test, the motor is rotated in open loop and feedback data is gathered. The feedback data is then utilized in closed-loop operation.

The Motor Feedback Test is executed during commissioning.

1. Set parameter **4.3.1.6 Motor Feedback Test Mode** to **Enable Motor Feedback Test**.

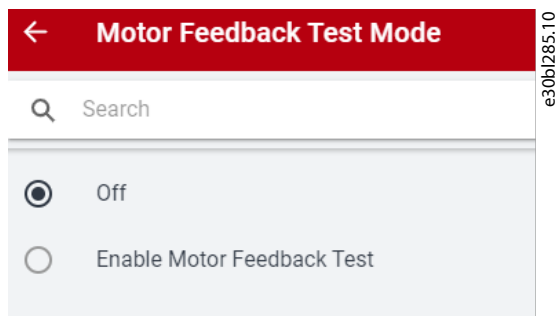

Figure 61: Motor Feedback Test Mode in MyDrive® Insight

➔ The warning **Feedback Test Active (5600)** is issued, and normal start is suppressed until the test is executed.

2. Give the start command.

➔ The motor accelerates to 60 RPM and runs for 1 second. The test samples the feedback signal. The motor stops after 1 second and the drive reports the test result. Parameter **4.3.1.6 Motor Feedback Test Mode** is set to **Off**.

➔ The outcome of the test can be:

- Success: The drive issues **Info 5601: Feedback Test Successful** and a pop-up dialog with the same message.
- Feedback signal was negative running whereas motor was positive: The drive issues **Fault 5604: Motor Feedback Inversed**.
- Feedback signal was 0 or very low: The drive issues **Fault 5605: No Motor Feedback**.
- Feedback signal was faster than expected: The drive issues **Fault 5603: Feedback Resolution/Poles Low**.
- Feedback signal was slower than expected: The drive issues **Fault 5602: Feedback Resolution/Poles High**.
- Feedback signal was inconsistent: Drive issues **Fault 5606: Feedback Unstable**.

6.5.4.3 U/f Settings (Menu Index 4.3.2)

The parameters are used to set the U/f motor control curve manually. Make sure that the parameter **Motor Control Principle** is set to **U/f**.

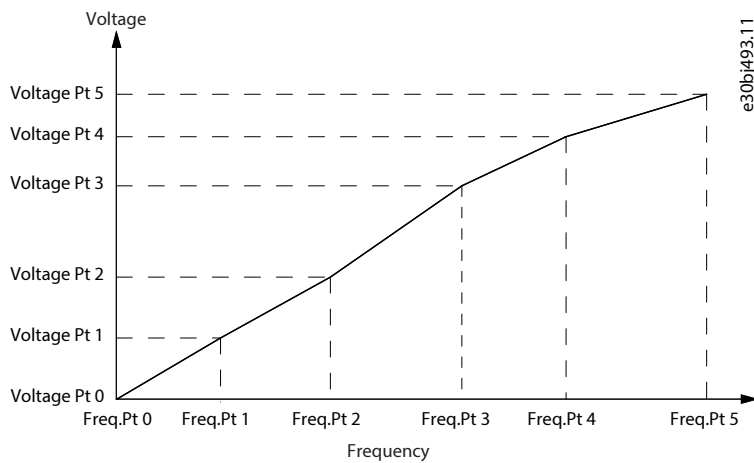

Figure 62: U/f Settings

P 4.3.2.1 Voltage Point 0

Set the U/f curve voltage point 0.

Default Value:	8	Parameter Type:	Range (0 — *)
Parameter Number:	2600	Unit:	V
Data Type:	REAL	Access Type:	Read/Write

P 4.3.2.2 Voltage Point 1

Set the U/f curve voltage point 1.

Default Value:	80	Parameter Type:	Range (0 — *)
Parameter Number:	2601	Unit:	V
Data Type:	REAL	Access Type:	Read/Write

P 4.3.2.3 Voltage Point 2

Set the U/f curve voltage point 2.

Default Value:	160	Parameter Type:	Range (0 — *)
Parameter Number:	2602	Unit:	V
Data Type:	REAL	Access Type:	Read/Write

P 4.3.2.4 Voltage Point 3

Set the U/f curve voltage point 3.

Default Value:	240	Parameter Type:	Range (0 — *)
Parameter Number:	2603	Unit:	V
Data Type:	REAL	Access Type:	Read/Write

P 4.3.2.5 Voltage Point 4

Set the U/f curve voltage point 4.

Default Value:	320	Parameter Type:	Range (0 — *)
Parameter Number:	2604	Unit:	V

Data Type:	REAL	Access Type:	Read/Write
-------------------	------	---------------------	------------

P 4.3.2.6 Voltage Point 5

Set the U/f curve voltage point 5.

Default Value:	400	Parameter Type:	Range (0 — *)
Parameter Number:	2605	Unit:	V
Data Type:	REAL	Access Type:	Read/Write

P 4.3.2.7 Frequency Point 0

Set the U/f curve frequency point 0.

Default Value:	–	Parameter Type:	Range (0 — 2000)
Parameter Number:	2610	Unit:	Hz
Data Type:	REAL	Access Type:	Read/Write

P 4.3.2.8 Frequency Point 1

Set the U/f curve frequency point 1.

Default Value:	10	Parameter Type:	Range (0 — 2000)
Parameter Number:	2611	Unit:	Hz
Data Type:	REAL	Access Type:	Read/Write

P 4.3.2.9 Frequency Point 2

Set the U/f curve frequency point 2.

Default Value:	20	Parameter Type:	Range (0 — 2000)
Parameter Number:	2612	Unit:	Hz
Data Type:	REAL	Access Type:	Read/Write

P 4.3.2.10 Frequency Point 3

Set the U/f curve frequency point 3.

Default Value:	30	Parameter Type:	Range (0 — 2000)
Parameter Number:	2613	Unit:	Hz
Data Type:	REAL	Access Type:	Read/Write

P 4.3.2.11 Frequency Point 4

Set the U/f curve frequency point 4.

Default Value:	40	Parameter Type:	Range (0 — 2000)
Parameter Number:	2614	Unit:	Hz
Data Type:	REAL	Access Type:	Read/Write

P 4.3.2.12 Frequency Point 5

Set the U/f curve frequency point 5.

Default Value:	50	Parameter Type:	Range (0 — 2000)
Parameter Number:	2615	Unit:	Hz
Data Type:	REAL	Access Type:	Read/Write

6.5.4.4 FVC+ Settings (Menu Index 4.3.3)

P 4.3.3.1 Continuous Rs Estimation

Enables Rs estimation while running, to compensate for changing operating conditions.

Default Value:	1 (Enabled)	Parameter Type:	Selection
Parameter Number:	428	Unit:	–
Data Type:	BOOL	Access Type:	Read/Write

The following are the selections for the parameter.

Selection Number	Selection Name	Selection Description
0	Disabled	Disables the function.
1	Enabled	Enables the function.

P 4.3.3.2 Current Controller Kp

Set the scaling of the current controller nominal proportional gain.

Default Value:	100	Parameter Type:	Range (0 — 100000)
Parameter Number:	8021	Unit:	%
Data Type:	REAL	Access Type:	Read/Write

P 4.3.3.3 Current Controller Ti

Set the scaling of the current controller nominal integral time.

Default Value:	100	Parameter Type:	Range (0.1 — 100000)
Parameter Number:	8022	Unit:	%
Data Type:	REAL	Access Type:	Read/Write

P 4.3.3.5 Low-speed Mode

Select the motor control mode used at low speeds.

Default Value:	0 (Selected motor control)	Parameter Type:	Selection
Parameter Number:	2816	Unit:	–
Data Type:	UINT	Access Type:	Read/Write

The following are the selections for the parameter.

Selection Number	Selection Name	Selection Description
0	Selected motor control	Uses the selected motor control at low speed.
1	Forced current mode (I/f Control)	Selects robust I/f current control at low speed.

Selection Number	Selection Name	Selection Description
2	HF injection	Adds HF injection to improve speed estimation performance at low speed.
3	Low speed minimum current (only in FVC SM)	Ensures a minimum current in FVC+ speed mode at low speed.
4	Saliency Tracking	Adds saliency tracking at low speed.

P 4.3.3.6 I/f Control Current Reference

Set the I/f control current reference in % of nominal motor current.

Default Value:	100	Parameter Type:	Range (0 — 500)
Parameter Number:	2817	Unit:	%
Data Type:	REAL	Access Type:	Read/Write

P 4.3.3.7 I/f Control Speed Threshold

Set the speed below which the I/f control is used.

Default Value:	10	Parameter Type:	Range (1 — *)
Parameter Number:	2818	Unit:	Hz
Data Type:	REAL	Access Type:	Read/Write

P 4.3.3.8 Low Speed Minimum Current

Set the low-speed minimum current reference in % of nominal motor current.

Default Value:	50	Parameter Type:	Range (0 — 100)
Parameter Number:	2837	Unit:	%
Data Type:	REAL	Access Type:	Read/Write

P 4.3.3.9 Minimum Current Speed Threshold

Set the speed below which the minimum current control is used.

Default Value:	10	Parameter Type:	Range (1 — *)
Parameter Number:	2838	Unit:	Hz
Data Type:	REAL	Access Type:	Read/Write

P 4.3.3.11 Relative HF Injection Voltage Gain

Set the voltage gain for HF injection relative to the recommended voltage.

Default Value:	100	Parameter Type:	Range (5 — 2000)
Parameter Number:	2821	Unit:	%
Data Type:	REAL	Access Type:	Read/Write

P 4.3.3.12 Relative HF Inject Bandwidth

Set the bandwidth for HF injection relative to the recommended bandwidth.

Default Value:	100	Parameter Type:	Range (1 — 1000)
-----------------------	-----	------------------------	------------------

Parameter Number:	2826	Unit:	%
Data Type:	REAL	Access Type:	Read/Write

P 4.3.3.13 HF Injection Angle Comp. Gain

Set the HF injection angle error compensation gain in degrees per nominal load torque.

Default Value:	–	Parameter Type:	Range (-35 — 35)
Parameter Number:	2822	Unit:	°
Data Type:	REAL	Access Type:	Read/Write

P 4.3.3.14 HF Injection Angle Comp. Offset

Set the HF injection angle error compensation offset in degrees.

Default Value:	–	Parameter Type:	Range (-25 — 25)
Parameter Number:	2824	Unit:	°
Data Type:	REAL	Access Type:	Read/Write

P 4.3.3.15 HF Injection Frequency

Set the HF injection frequency. Setting 0 is equal to automatic setting of injection frequency.

Default Value:	–	Parameter Type:	Range (0 — *)
Parameter Number:	2823	Unit:	Hz
Data Type:	REAL	Access Type:	Read/Write

P 4.3.3.16 IdIq Reference Ratio

Set the synchronous motor Id/Iq current reference ratio in %. It is used instead of the default MTPA, if it is set to be different from 0.

Default Value:	–	Parameter Type:	Range (-100 — 100)
Parameter Number:	1219	Unit:	%
Data Type:	REAL	Access Type:	Read/Write

P 4.3.3.18 Encoder Slip Adjustment

Enables the encoder slip correction function for permanent magnet motors in closed loop FVC+ control.

Default Value:	False	Parameter Type:	Selection
Parameter Number:	4602	Unit:	–
Data Type:	BOOL	Access Type:	Read/Write

The following are the selections for the parameter.

Selection Number	Selection Name	Selection Description
0	Disabled	Disables the function.
1	Enabled	Enables the function.

P 4.3.3.19 Torque Estimation Bandwidth

Set scaling factor for torque estimation correction bandwidth. 100% = default tuning, 0% = disable. Applies only to permanent magnet motors.

Default Value:	100	Parameter Type:	Range (0 — 1000)
Parameter Number:	4612	Unit:	%
Data Type:	REAL	Access Type:	Read/Write

6.5.4.5 VVC+ & U/f Settings (Menu Index 4.3.4)

P 4.3.4.1 Slip Compensation

Set the slip compensation in % of nominal motor slip.

Default Value:	100	Parameter Type:	Range (0 — 1000)
Parameter Number:	2804	Unit:	%
Data Type:	REAL	Access Type:	Read/Write

P 4.3.4.2 Slip Compensation Tc

Set the slip compensation time constant.

Default Value:	50.00	Parameter Type:	Range (0.00 — 100000.00)
Parameter Number:	2805	Unit:	ms
Data Type:	REAL	Access Type:	Read/Write

P 4.3.4.3 High-speed Load Comp.

Set the high-speed load compensation in % of the motor voltage drop.

Default Value:	100	Parameter Type:	Range (0 — 1000)
Parameter Number:	2803	Unit:	%
Data Type:	REAL	Access Type:	Read/Write

The parameters **4.3.4.3 High-speed Load Comp.** and **4.3.4.4 Low Speed Load Comp.** are used to set the % value to compensate voltage in relation to load when the motor is running at high/low speed, and obtain the optimum U/f characteristics. The motor size determines the frequency range within which the parameters are active, as shown in the illustration.

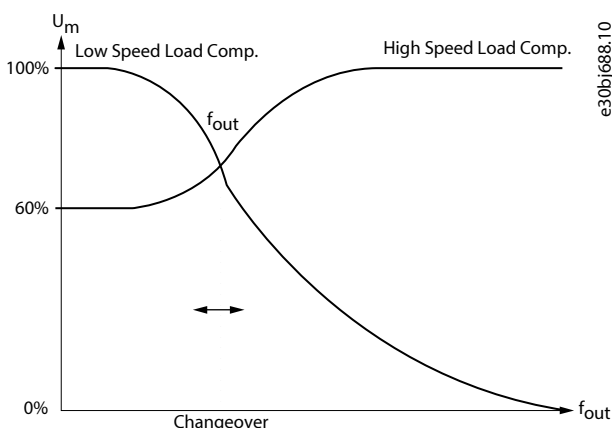

Figure 63: Changeover from Low Speed Load Compensation to High Speed Load Compensation

P 4.3.4.4 Low-speed Load Comp.

Set the low-speed load compensation in % of the motor voltage drop.

Default Value:	100	Parameter Type:	Range (0 — 1000)
Parameter Number:	2802	Unit:	%
Data Type:	REAL	Access Type:	Read/Write

P 4.3.4.5 Res. Damp. Gain

Set the resonance damping gain in % of nominal slip for induction motors, and 0.1 times the nominal frequency for permanent magnet motors.

Default Value:	100	Parameter Type:	Range (0 — 50000)
Parameter Number:	2806	Unit:	%
Data Type:	REAL	Access Type:	Read/Write

P 4.3.4.6 Res. Damp. High Pass Tc

Set the resonance damping high-pass time constant.

Default Value:	50.00	Parameter Type:	Range (0.00 — 100000.00)
Parameter Number:	2807	Unit:	ms
Data Type:	REAL	Access Type:	Read/Write

P 4.3.4.7 Res. Damp Low Pass Tc

Set the resonance damping low-pass time constant.

Default Value:	1.00	Parameter Type:	Range (0.00 — 100000.00)
Parameter Number:	2808	Unit:	ms
Data Type:	REAL	Access Type:	Read/Write

P 4.3.4.9 Res. Damp. High Pass Tc (SM)

Set time constant of resonance damping for VVC+ control of synchronous motors (SM).

Default Value:	–	Parameter Type:	Range (0 — 1)
Parameter Number:	2819	Unit:	s
Data Type:	REAL	Access Type:	Read/Write

P 4.3.4.10 Motor Model Tc (SM)

Set the time constant of the internal model used for VVC+ control of synchronous motors (SM). A lower value improves the dynamic control performance. A higher value improves the noise reduction.

Default Value:	–	Parameter Type:	Range (0 — 1)
Parameter Number:	2820	Unit:	s
Data Type:	REAL	Access Type:	Read/Write

P 4.3.4.11 Low Speed Minimum Current

Set the low-speed minimum current reference in % of nominal motor current.

Default Value:	50	Parameter Type:	Range (0 — 100)
Parameter Number:	2837	Unit:	%

Data Type:	REAL	Access Type:	Read/Write
-------------------	------	---------------------	------------

P 4.3.4.12 Nominal Magnetization Speed

Set the minimum speed for nominal motor magnetization. Used by constant torque (CT).

Default Value:	0.5	Parameter Type:	Range (0 — 1000)
Parameter Number:	2844	Unit:	Hz
Data Type:	REAL	Access Type:	Read/Write

P 4.3.4.13 Zero Speed Magnetization

Set the % of motor magnetization at 0 speed used by constant torque (CT). The selection of a low value reduces energy loss in the motor, but also reduces load capacity.

Default Value:	100	Parameter Type:	Range (0 — 1000)
Parameter Number:	2845	Unit:	%
Data Type:	REAL	Access Type:	Read/Write

P 4.3.4.14 Current Limiter Kp

Set the proportional gain of the current limit controller.

Default Value:	100	Parameter Type:	Range (0 — 500)
Parameter Number:	3193	Unit:	%
Data Type:	REAL	Access Type:	Read/Write

P 4.3.4.15 Current Limiter Ti

Set the integration time of the current limit controller. The value is scaled to % of the nominal setting.

Default Value:	100	Parameter Type:	Range (0 — 500)
Parameter Number:	3194	Unit:	%
Data Type:	REAL	Access Type:	Read/Write

6.5.5 Protection (Menu Index 4.5)

P 4.5.1 Missing Phase Start-up Detection

Enables detection of missing motor phase at start-up.

Default Value:	0 (Disabled)	Parameter Type:	Selection
Parameter Number:	6070	Unit:	—
Data Type:	UINT	Access Type:	Read/Write

The following are the selections for the parameter.

Selection Number	Selection Name	Selection Description
0	Disabled	Disables the function.
1	Enabled	Enables the function.

P 4.5.2 Missing Motor Phase Response

Select the response to a missing motor phase.

Default Value:	1 (Fault)	Parameter Type:	Selection
Parameter Number:	2348	Unit:	–
Data Type:	UINT	Access Type:	Read/Write

The following are the selections for the parameter.

Selection Number	Selection Name	Selection Description
0	No response	The event is ignored.
2	Warning	The drive issues a warning.
1	Fault	The drive issues a fault and coasts the motor.

P 4.5.3 Disconnected Motor Response

Select the response to a disconnected motor.

Default Value:	0 (No response)	Parameter Type:	Selection
Parameter Number:	2349	Unit:	–
Data Type:	UINT	Access Type:	Read/Write

The following are the selections for the parameter.

Selection Number	Selection Name	Selection Description
0	No response	The event is ignored.
2	Warning	The drive issues a warning.
1	Fault	The drive issues a fault and coasts the motor.
3	Motor Check	The drive checks if the motor is reconnected and resumes operation.

P 4.5.4 ETR Overtemperature Response

Select the response to motor overtemperature indicated by the electronic thermal relay (ETR).

Default Value:	0 (No response)	Parameter Type:	Selection
Parameter Number:	2825	Unit:	–
Data Type:	UINT	Access Type:	Read/Write

The following are the selections for the parameter.

Selection Number	Selection Name	Selection Description
0	No response	The event is ignored.
1	Info	The event is logged in the event log.
3	Warning	The drive issues a warning.

Selection Number	Selection Name	Selection Description
9	Fault, ramp to coast	Issues a fault, ramps down, and coast.
10	Fault	The drive issues a fault and coasts the motor.

P 4.5.5 Motor Thermistor Input

Select an input for the motor thermistor feedback.

Default Value:	–	Parameter Type:	Selection
Parameter Number:	2839	Unit:	–
Data Type:	UINT	Access Type:	Read/Write

P 4.5.6 Motor Thermistor Response

Select the response to a motor thermistor event.

Default Value:	9 (Fault, ramp to coast)	Parameter Type:	Selection
Parameter Number:	2846	Unit:	–
Data Type:	UINT	Access Type:	Read/Write

The following are the selections for the parameter.

Selection Number	Selection Name	Selection Description
3	Warning	The drive issues a warning.
9	Fault, ramp to coast	Issues a fault, ramps down, and coast.
10	Fault	The drive issues a fault and coasts the motor.

P 4.5.7 Motor Temperature Input

Select the input for the motor temperature sensor.

Default Value:	–	Parameter Type:	Selection
Parameter Number:	2847	Unit:	–
Data Type:	UINT	Access Type:	Read/Write

P 4.5.8 Motor Temperature Warning Level

Set the temperature level for issuing a warning.

Default Value:	120	Parameter Type:	Range (-300 — 300)
Parameter Number:	2848	Unit:	°C
Data Type:	REAL	Access Type:	Read/Write

P 4.5.9 Motor Temperature Fault Level

Set the temperature level for issuing a fault. The response is ramp down and coast.

Default Value:	150	Parameter Type:	Range (-300 — 300)
Parameter Number:	2919	Unit:	°C

Data Type:	REAL	Access Type:	Read/Write
-------------------	------	---------------------	------------

P 4.5.10 Motor Sync Loss

Select the drive response if the synchronization between motor and drive is lost. This is only relevant when using a permanent magnet or synchronous reluctance motor.

Default Value:	3 (Warning)	Parameter Type:	Selection
Parameter Number:	2922	Unit:	–
Data Type:	UINT	Access Type:	Read/Write

The following are the selections for the parameter.

Selection Number	Selection Name	Selection Description
0	Disable	Synchronization loss detection is disabled.
1	Fault	The drive issues a fault if this event happens.
3	Warning	The drive will issue a warning if this event happens.

6.6 Application (Menu Index 5)

6.6.1 Application Overview

This parameter group contains parameters for application specific features such as process control, speed control, torque control, mechanical brake control, and many more.

6.6.2 Application Status (Menu Index 5.1)

P 5.1.1 Motor Ctrl. Status Word

Shows the motor control status word.

Default Value:	NA	Parameter Type:	Range (* — *)
Parameter Number:	1714	Unit:	–
Data Type:	WORD	Access Type:	Read Only

Table 37: Motor Ctrl. Status Word bit descriptions

Bit	Description
0	Ready
1	Run
2	Reverse
3	Fault
4	Reserved
5	At reference
6	Zero speed
7	Protection mode active

P 5.1.2 Motor Ctrl. Ready Status Word

Shows the motor control ready status word. All status bits must be true before the drive is ready.

Default Value:	NA	Parameter Type:	Range (* — *)
Parameter Number:	1716	Unit:	–
Data Type:	WORD	Access Type:	Read Only

Table 38: Motor Ctrl. Ready Status Word bit descriptions

Bit	Description
0	Run Enable high.
1	No fault active.
2	DC-link pre-charging done.
3	DC Voltage within limits.
4	Power manager initialized.
5	Brake test not running.
6	System software is not blocking start.
7	Grid voltage within limits.
8	Temperature within limits.
9	Valid motor data.
10	Valid control configuration.

P 5.1.3 Motor Regulator Status Word

Shows the current state of the motor regulator status word. The status word indicates if a limit controller is active.

Default Value:	NA	Parameter Type:	Range (* — *)
Parameter Number:	1715	Unit:	–
Data Type:	WORD	Access Type:	Read Only

Table 39: Motor Regulator Status Word bit descriptions

Bit	Description
0	Current limit control active (motoring side).
1	Current limit control active (generator side).
2	Torque limit control active (motoring side).
3	Torque limit control active (generator side).
4	Overvoltage control active.
5	Undervoltage control active.
6	Power limit control active (motoring side).
7	Power limit control active (generator side).
8	Speed limit control active.
9	AC-brake control active.

P 5.1.5 Fault Status Word 1

Shows the fault status word 1.

Default Value:	–	Parameter Type:	Range (* — *)
Parameter Number:	6203	Unit:	–
Data Type:	DWORD	Access Type:	–

Table 40: Fault Status Word 1 bit descriptions

Bit	Description	Event number
0	Overcurrent	4384, 4373, 5170, 4368, 4369, 4375, 4377, 4380, 4097
1	Overvoltage	4164, 4162, 4144 4145
2	Undervoltage	4165, 4146
3	Unit temperature high	4117, 4118, 4119
4	Unit temperature low	4116
5	Control board overtemperature	4121, 4122, 4123, 4120
6	Input phase	4160, 4163
7	Output phase	4175, 4176
8	Ground fault	4379, 4352, 4353, 4354, 4355
9	Fan failure	4128, 4129, 4133, 4130
10	Fieldbus communication	5162, 4256, 4257, 4258, 4260, 4261, 4263, 4265, 4266, 4267, 4268, 4269, 4280, 4281, 4270, 4271, 4272, 4273, 4282, 4274, 4275, 4276, 4277, 4283, 4278, 4279
11	HMI connection	5141, 5142
12	Feedback connection	4418
13	Thermistor input	5157
14	Auxiliary device (temperature)	4200, 4201, 4203, 4202
15	External temperature measurement	5132, 5133, 5134, 5135, 5136, 5137, 5158

P 5.1.8 Warning Status Word 1

Shows the warning status word 1.

Default Value:	–	Parameter Type:	Range (* — *)
Parameter Number:	6205	Unit:	–
Data Type:	DWORD	Access Type:	–

Table 41: Warning Status Word 1 bit descriptions

Bit	Description	Event number
0	Overcurrent	4384, 4373, 5170, 4368, 4369, 4375, 4377, 4380, 4097
1	Overvoltage	4164, 4162, 4144 4145
2	Undervoltage	4165, 4146
3	Unit temperature high	4117, 4118, 4119

Table 41: Warning Status Word 1 bit descriptions (continued)

Bit	Description	Event number
4	Unit temperature low	4116
5	Control board overtemperature	4121, 4122, 4123, 4120
6	Input phase	4160, 4163
7	Output phase	4175, 4176
8	Ground fault	4379, 4352, 4353, 4354, 4355
9	Fan failure	4128, 4129, 4133, 4130
10	Fieldbus communication	5162, 4256, 4257, 4258, 4260, 4261, 4263, 4265, 4266, 4267, 4268, 4269, 4280, 4281, 4270, 4271, 4272, 4273, 4282, 4274, 4275, 4276, 4277, 4283, 4278, 4279
11	HMI connection	5141, 5142
12	Feedback connection	4418
13	Thermistor input	5157
14	Auxiliary device (temperature)	4200, 4201, 4203, 4202
15	External temperature measurement	5132, 5133, 5134, 5135, 5136, 5137, 5158

P 5.1.13 Application Status Word

Shows the application-specific status word.

Default Value:	NA	Parameter Type:	Range (* — *)
Parameter Number:	1608	Unit:	–
Data Type:	WORD	Access Type:	Read Only

Table 42: Application Status Word bit descriptions

Bit	Bit = False	Bit = True
0	Local Control	Remote Control
1	Inching not Active	Inching Active
2	Process Control not Active	Process Control Active
3	-	Start Interlock
4	STO Not Active	STO Active
5	No Warning	Warning Active
6	No Fault	Fault Active
7	Reserved	Reserved
8	Reserved	Reserved
9	Reserved	Reserved
10	Reserved	Reserved
11	Reserved	Reserved
12	Reserved	Reserved
13	Normal Reference	Freeze Reference

Table 42: Application Status Word bit descriptions (continued)

Bit	Bit = False	Bit = True
14	Normal Reference	Reverse Reference
15	Speed Within Limits	Speed Limit Active

6.6.3 Protection (Menu Index 5.2)

6.6.3.1 Cooling Monitor (Menu Index 5.2.1)

P 5.2.1.1 Cooling Monitor Input

Select the input for the negated cooling monitor signal.

Default Value:	–	Parameter Type:	Selection
Parameter Number:	2400	Unit:	–
Data Type:	UINT	Access Type:	Read/Write

P 5.2.1.2 Cooling Monitor Fault Delay

Set a delay before the cooling monitor issues a fault. Only valid if fault is selected.

Default Value:	3	Parameter Type:	Range (0 — 100)
Parameter Number:	2401	Unit:	s
Data Type:	REAL	Access Type:	Read/Write

P 5.2.1.3 Cooling Monitor Response

Select the response to a missing cooling monitor signal. The response is selected for both stopped and running states.

Default Value:	2 (Warning, Fault after Timeout while running)	Parameter Type:	Selection
Parameter Number:	2402	Unit:	–
Data Type:	UINT	Access Type:	Read/Write

The following are the selections for the parameter.

Selection Number	Selection Name	Selection Description
0	Warning while running	The drive issues a warning if the drive is in running state.
1	Warning	Drive issues a warning immediately.
2	Warning, Fault after Timeout while running	Drive issues a warning immediately, and if the drive is running, the warning escalates into a fault after a timeout.
3	Warning and Fault after Timeout while running	When stopped, no response is given. When running, the drive issues a warning immediately. The warning escalates into a fault after a timeout.

6.6.3.2 External Event (Menu Index 5.2.2)

Events can be issued via an external signal with the parameters of the External Event parameter group. The event can be delayed with parameters [5.2.2.9 External Event 1 Delay](#) and [5.2.2.10 External Event 2 Delay](#).

P 5.2.2.1 External Event 1 Input

Select an input for the external event.

Default Value:	–	Parameter Type:	Selection
Parameter Number:	4557	Unit:	–
Data Type:	UINT	Access Type:	Read/Write

P 5.2.2.3 External Event 1 Response

Select the response to an external event.

Default Value:	9 (Fault, ramp to coast)	Parameter Type:	Selection
Parameter Number:	4559	Unit:	–
Data Type:	UINT	Access Type:	Read/Write

The following are the selections for the parameter.

Selection Number	Selection Name	Selection Description
0	No response	The event is ignored.
1	Info	The event is logged in the event log.
3	Warning	The drive issues a warning.
9	Fault, ramp to coast	Issues a fault, ramps down, and coast.
10	Fault	The drive issues a fault and coasts the motor.

P 5.2.2.4 External Event 2 Input

Select an input for the external event.

Default Value:	–	Parameter Type:	Selection
Parameter Number:	4560	Unit:	–
Data Type:	UINT	Access Type:	Read/Write

P 5.2.2.6 External Event 2 Response

Select the response to an external event.

Default Value:	9 (Fault, ramp to coast)	Parameter Type:	Selection
Parameter Number:	4562	Unit:	–
Data Type:	UINT	Access Type:	Read/Write

The following are the selections for the parameter.

Selection Number	Selection Name	Selection Description
0	No response	The event is ignored.
1	Info	The event is logged in the event log.
3	Warning	The drive issues a warning.

Selection Number	Selection Name	Selection Description
9	Fault, ramp to coast	Issues a fault, ramps down, and coast.
10	Fault	The drive issues a fault and coasts the motor.

P 5.2.2.7 External Event Active Output

Select an output indicating an external event.

Default Value:	–	Parameter Type:	Selection
Parameter Number:	5184	Unit:	–
Data Type:	UINT	Access Type:	Read/Write

P 5.2.2.9 External Event 1 Delay

Set the time delay before external event 1 is raised.

Default Value:	–	Parameter Type:	Range (0 — 600)
Parameter Number:	4592	Unit:	s
Data Type:	REAL	Access Type:	Read/Write

P 5.2.2.10 External Event 2 Delay

Set the time delay before external event 2 is raised.

Default Value:	–	Parameter Type:	Range (0 — 600)
Parameter Number:	4593	Unit:	s
Data Type:	REAL	Access Type:	Read/Write

6.6.3.3 Measured Temp. Protection (Menu Index 5.2.3)

6.6.3.3.1 Measured Temp. Protection Status (Menu Index 5.2.3.1)

P 5.2.3.1.1 Protection 1 Temp.

Shows the temperature measured for the temperature protection.

Default Value:	NA	Parameter Type:	Range (-300 — 300)
Parameter Number:	5200	Unit:	°C
Data Type:	REAL	Access Type:	Read Only

P 5.2.3.1.2 Protection 2 Temp.

Shows the temperature measured for the temperature protection.

Default Value:	NA	Parameter Type:	Range (-300 — 300)
Parameter Number:	5201	Unit:	°C
Data Type:	REAL	Access Type:	Read Only

P 5.2.3.1.3 Protection 3 Temp.

Shows the temperature measured for the temperature protection.

Default Value:	NA	Parameter Type:	Range (-300 — 300)
-----------------------	----	------------------------	--------------------

Parameter Number: 5202	Unit: °C
Data Type: REAL	Access Type: Read Only

P 5.2.3.1.4 Protection 4 Temp.

Shows the temperature measured for the temperature protection.

Default Value: NA	Parameter Type: Range (-300 — 300)
Parameter Number: 5203	Unit: °C
Data Type: REAL	Access Type: Read Only

P 5.2.3.1.5 Protection 5 Temp.

Shows the temperature measured for the temperature protection.

Default Value: NA	Parameter Type: Range (-300 — 300)
Parameter Number: 5204	Unit: °C
Data Type: REAL	Access Type: Read Only

P 5.2.3.1.6 Protection 6 Temp.

Shows the temperature measured for the temperature protection.

Default Value: NA	Parameter Type: Range (-300 — 300)
Parameter Number: 5205	Unit: °C
Data Type: REAL	Access Type: Read Only

6.6.3.3.2 Temp. 1 Protection (Menu Index 5.2.3.2)

P 5.2.3.2.1 Temp. 1 Input

Select the temperature sensor input for the temperature protection.

Default Value: –	Parameter Type: Selection
Parameter Number: 5206	Unit: –
Data Type: UINT	Access Type: Read/Write

P 5.2.3.2.2 Temp. 1 Limit 1

Set the temperature level for issuing a warning.

Default Value: 120	Parameter Type: Range (-300 — 300)
Parameter Number: 5207	Unit: °C
Data Type: REAL	Access Type: Read/Write

P 5.2.3.2.3 Temp. 1 Limit 2

Set the temperature level for issuing a protection response.

Default Value: 150	Parameter Type: Range (-300 — 300)
Parameter Number: 5208	Unit: °C
Data Type: REAL	Access Type: Read/Write

P 5.2.3.2.4 Temp. 1 Limit 2 Response

Select the response for exceeding the limit.

Default Value:	9 (Fault, ramp to coast)	Parameter Type:	Selection
Parameter Number:	5209	Unit:	–
Data Type:	UINT	Access Type:	Read/Write

The following are the selections for the parameter.

Selection Number	Selection Name	Selection Description
3	Warning	The drive issues a warning.
9	Fault, ramp to coast	Issues a fault, ramps down, and coast.
10	Fault	The drive issues a fault and coasts the motor.

6.6.3.3.3 Temp. 2 Protection (Menu Index 5.2.3.3)

P 5.2.3.3.1 Temp. 2 Input

Select the temperature sensor input for the temperature protection.

Default Value:	–	Parameter Type:	Selection
Parameter Number:	5210	Unit:	–
Data Type:	UINT	Access Type:	Read/Write

P 5.2.3.3.2 Temp. 2 Limit 1

Set the temperature level for issuing a warning.

Default Value:	120	Parameter Type:	Range (-300 — 300)
Parameter Number:	5211	Unit:	°C
Data Type:	REAL	Access Type:	Read/Write

P 5.2.3.3.3 Temp. 2 Limit 2

Set the temperature level for issuing a protection response.

Default Value:	150	Parameter Type:	Range (-300 — 300)
Parameter Number:	5212	Unit:	°C
Data Type:	REAL	Access Type:	Read/Write

P 5.2.3.3.4 Temp. 2 Limit 2 Response

Select the response for exceeding the limit.

Default Value:	9 (Fault, ramp to coast)	Parameter Type:	Selection
Parameter Number:	5213	Unit:	–
Data Type:	UINT	Access Type:	Read/Write

The following are the selections for the parameter.

Selection Number	Selection Name	Selection Description
3	Warning	The drive issues a warning.
9	Fault, ramp to coast	Issues a fault, ramps down, and coast.
10	Fault	The drive issues a fault and coasts the motor.

6.6.3.3.4 Temp. 3 Protection (Menu Index 5.2.3.4)

P 5.2.3.4.1 Temp. 3 Input

Select the temperature sensor input for the temperature protection.

Default Value:	–	Parameter Type:	Selection
Parameter Number:	5214	Unit:	–
Data Type:	UINT	Access Type:	Read/Write

P 5.2.3.4.2 Temp. 3 Limit 1

Set the temperature level for issuing a warning.

Default Value:	120	Parameter Type:	Range (-300 — 300)
Parameter Number:	5215	Unit:	°C
Data Type:	REAL	Access Type:	Read/Write

P 5.2.3.4.3 Temp. 3 Limit 2

Set the temperature level for issuing a protection response.

Default Value:	150	Parameter Type:	Range (-300 — 300)
Parameter Number:	5216	Unit:	°C
Data Type:	REAL	Access Type:	Read/Write

P 5.2.3.4.4 Temp. 3 Limit 2 Response

Select the response for exceeding the limit.

Default Value:	9 (Fault, ramp to coast)	Parameter Type:	Selection
Parameter Number:	5217	Unit:	–
Data Type:	UINT	Access Type:	Read/Write

The following are the selections for the parameter.

Selection Number	Selection Name	Selection Description
3	Warning	The drive issues a warning.
9	Fault, ramp to coast	Issues a fault, ramps down, and coast.
10	Fault	The drive issues a fault and coasts the motor.

6.6.3.3.5 Temp. 4 Protection (Menu Index 5.2.3.5)

P 5.2.3.5.1 Temp. 4 Input

Select the temperature sensor input for the temperature protection.

Default Value:	–	Parameter Type:	Selection
Parameter Number:	5218	Unit:	–
Data Type:	UINT	Access Type:	Read/Write

P 5.2.3.5.2 Temp. 4 Limit 1

Set the temperature level for issuing a warning.

Default Value:	120	Parameter Type:	Range (-300 — 300)
Parameter Number:	5219	Unit:	°C
Data Type:	REAL	Access Type:	Read/Write

P 5.2.3.5.3 Temp. 4 Limit 2

Set the temperature level for issuing a protection response.

Default Value:	150	Parameter Type:	Range (-300 — 300)
Parameter Number:	5220	Unit:	°C
Data Type:	REAL	Access Type:	Read/Write

P 5.2.3.5.4 Temp. 4 Limit 2 Response

Select the response for exceeding the limit.

Default Value:	9 (Fault, ramp to coast)	Parameter Type:	Selection
Parameter Number:	5221	Unit:	–
Data Type:	UINT	Access Type:	Read/Write

The following are the selections for the parameter.

Selection Number	Selection Name	Selection Description
3	Warning	The drive issues a warning.
9	Fault, ramp to coast	Issues a fault, ramps down, and coast.
10	Fault	The drive issues a fault and coasts the motor.

6.6.3.3.6 Temp. 5 Protection (Menu Index 5.2.3.6)

P 5.2.3.6.1 Temp. 5 Input

Select the temperature sensor input for the temperature protection.

Default Value:	–	Parameter Type:	Selection
Parameter Number:	5222	Unit:	–
Data Type:	UINT	Access Type:	Read/Write

P 5.2.3.6.2 Temp. 5 Limit 1

Set the temperature level for issuing a warning.

Default Value:	120	Parameter Type:	Range (-300 — 300)
Parameter Number:	5223	Unit:	°C

Data Type: REAL **Access Type:** Read/Write

P 5.2.3.6.3 Temp. 5 Limit 2

Set the temperature level for issuing a protection response.

Default Value: 150 **Parameter Type:** Range (-300 — 300)
Parameter Number: 5224 **Unit:** °C
Data Type: REAL **Access Type:** Read/Write

P 5.2.3.6.4 Temp. 5 Limit 2 Response

Select the response for exceeding the limit.

Default Value: 9 (Fault, ramp to coast) **Parameter Type:** Selection
Parameter Number: 5225 **Unit:** –
Data Type: UINT **Access Type:** Read/Write

The following are the selections for the parameter.

Selection Number	Selection Name	Selection Description
3	Warning	The drive issues a warning.
9	Fault, ramp to coast	Issues a fault, ramps down, and coast.
10	Fault	The drive issues a fault and coasts the motor.

6.6.3.3.7 **Temp. 6 Protection (Menu Index 5.2.3.7)**

P 5.2.3.7.1 Temp. 6 Input

Select the temperature sensor input for the temperature protection.

Default Value: – **Parameter Type:** Selection
Parameter Number: 5226 **Unit:** –
Data Type: UINT **Access Type:** Read/Write

P 5.2.3.7.2 Temp. 6 Limit 1

Set the temperature level for issuing a warning.

Default Value: 120 **Parameter Type:** Range (-300 — 300)
Parameter Number: 5227 **Unit:** °C
Data Type: REAL **Access Type:** Read/Write

P 5.2.3.7.3 Temp. 6 Limit 2

Set the temperature level for issuing a protection response.

Default Value: 150 **Parameter Type:** Range (-300 — 300)
Parameter Number: 5228 **Unit:** °C
Data Type: REAL **Access Type:** Read/Write

P 5.2.3.7.4 Temp. 6 Limit 2 Response

Select the response for exceeding the limit.

Default Value:	9 (Fault, ramp to coast)	Parameter Type:	Selection
Parameter Number:	5229	Unit:	–
Data Type:	UINT	Access Type:	Read/Write

The following are the selections for the parameter.

Selection Number	Selection Name	Selection Description
3	Warning	The drive issues a warning.
9	Fault, ramp to coast	Issues a fault, ramps down, and coast.
10	Fault	The drive issues a fault and coasts the motor.

6.6.3.4 Blocked Rotor Detection (Menu Index 5.2.6)

Use the blocked rotor detection function to detect if the rotor is blocked by the application. This feature can protect the motor or application and identify if something is preventing the drive from ramping up the motor to the desired speed reference. If the motor is running in either torque or current limit for the set detection time, the blocked rotor function triggers an event. The function only is active in the speed range from 0 up to the set blocked rotor maximum speed.

P 5.2.6.1 Blocked Rotor Response

Select how the drive responds when detecting a blocked rotor.

Default Value:	0 (No response)	Parameter Type:	Selection
Parameter Number:	2370	Unit:	–
Data Type:	UINT	Access Type:	Read/Write

The following are the selections for the parameter.

Selection Number	Selection Name	Selection Description
0	No response	The event is ignored.
3	Warning	The drive issues a warning.
1	Fault	The drive issues a fault and coasts the motor.

P 5.2.6.2 Blocked Rotor Max. Speed

Set the maximum speed for checking for a blocked rotor.

Default Value:	10	Parameter Type:	Range (0 — 100)
Parameter Number:	2371	Unit:	Hz
Data Type:	REAL	Access Type:	Read/Write

P 5.2.6.3 Blocked Rotor Detection Time

Set the duration that the rotor can be blocked before a response is triggered.

Default Value:	0.5	Parameter Type:	Range (0.1 — 100)
Parameter Number:	2372	Unit:	s

Data Type:	REAL	Access Type:	Read/Write
-------------------	------	---------------------	------------

6.6.3.5 Lost Load Detection (Menu Index 5.2.7)

P 5.2.7.1 Lost-load Response

Select an action for the lost-load detection. The lost-load detection is active if the motor speed is above 15 Hz.

Default Value:	0 (No response)	Parameter Type:	Selection
Parameter Number:	9072	Unit:	–
Data Type:	UINT	Access Type:	Read/Write

The following are the selections for the parameter.

Selection Number	Selection Name	Selection Description
0	No response	The event is ignored.
1	Info	The event is logged in the event log.
3	Warning	The drive issues a warning.
9	Fault, ramp to coast	Issues a fault, ramps down, and coast.
10	Fault	The drive issues a fault and coasts the motor.

P 5.2.7.2 Lost-load Detection Torque Level

Set the minimum allowed torque level in % of nominal motor torque. The lost-load detection can be activated below the set level.

Default Value:	10	Parameter Type:	Range (5 — 100)
Parameter Number:	9070	Unit:	%
Data Type:	REAL	Access Type:	Read/Write

P 5.2.7.3 Lost-load Detection Delay

Set the minimum duration that the torque has to be below the detection limit before activating the lost-load exception.

Default Value:	10	Parameter Type:	Range (0 — 600)
Parameter Number:	9071	Unit:	s
Data Type:	REAL	Access Type:	Read/Write

6.6.3.6 HMI Connection Loss (Menu Index 5.2.9)

P 5.2.9.1 HMI Connection Loss Response

Select the response after connection is lost to control panel or PC tool while they are in control. The response occurs after the timeout defined with 5.2.9.2 HMI Connection Loss Delay.

Default Value:	10 (Fault)	Parameter Type:	Selection
Parameter Number:	5420	Unit:	–
Data Type:	UINT	Access Type:	Read/Write

The following are the selections for the parameter.

Selection Number	Selection Name	Selection Description
0	No response	The event is ignored.
2	Info	The event is logged in the event log.
4	Warning - Persistent	The drive issues a warning that stays active until acknowledged by a reset.
9	Fault, ramp to coast	Issues a fault, ramps down, and coast.
10	Fault	The drive issues a fault and coasts the motor.

P 5.2.9.2 HMI Connection Loss Delay

Set the delay before the selected response is triggered after the drive loses connection to control panel or PC tool.

Default Value:	5	Parameter Type:	Range (0 — 120)
Parameter Number:	5421	Unit:	s
Data Type:	REAL	Access Type:	Read/Write

6.6.3.7 Live Zero (Menu Index 5.2.15)

P 5.2.15.2 Live Zero Response

Select the drive response to a missing input signal (live zero).

Default Value:	3 (Warning)	Parameter Type:	Selection
Parameter Number:	4555	Unit:	–
Data Type:	UINT	Access Type:	Read/Write

The following are the selections for the parameter.

Selection Number	Selection Name	Selection Description
0	No Action	The event is ignored.
1	Info	The event is logged in the event log.
3	Warning	The drive issues a warning.
10	Fault	The drive issues a fault.

6.6.3.8 Feedback Handling (Menu Index 5.2.16)

P 5.2.16.1 Failure Handling Response

Select the drive response to an encoder/resolver failure.

Default Value:	10 (Coast)	Parameter Type:	Selection
Parameter Number:	4600	Unit:	–
Data Type:	UINT	Access Type:	Read/Write

The following are the selections for the parameter.

Selection Number	Selection Name	Selection Description
3	Switch to Open Loop and Continue	The drive switches to open loop operation and continues running.
9	Switch to Open Loop and Ramp to Stop	The drive switches to open loop operation and ramps down to stop.
10	Coast	The drive coasts the motor.

6.6.4 Load (Menu Index 5.3)

6.6.4.1 Load Status (Menu Index 5.3.1)

P 5.3.1.1 Inertia Estimation Status

Shows the status of the inertia estimation routine. 0 = Inactive, 1 = In progress, 2 = Completed successfully, 3 = Completed unsuccessfully.

Default Value:	NA	Parameter Type:	Selection
Parameter Number:	666	Unit:	–
Data Type:	UINT	Access Type:	Read Only

The following are the selections for the parameter.

Selection Number	Selection Name	Selection Description
0	Inactive	
1	In progress	
2	Completed successfully	
3	Completed unsuccessfully	

6.6.4.2 Inertia (Menu Index 5.3.2)

P 5.3.2.1 Inertia Estimation Mode

Set the mode for the inertia estimation.

Default Value:	0 (Off)	Parameter Type:	Selection
Parameter Number:	668	Unit:	–
Data Type:	UINT	Access Type:	Read/Conditional Write

The following are the selections for the parameter.

Selection Number	Selection Name	Selection Description
0	Off	The feature is disabled.
1	Without load profile	The next start command initiates a test sequence - Without speed dependent load.
2	With load profile	The next start command initiates a test sequence - With speed dependent load.

P 5.3.2.2 Inertia Estimation Timeout

Set the time after which an event message is generated if inertia estimation cannot be finalized.

Default Value:	900	Parameter Type:	Range (120 — 1800)
Parameter Number:	669	Unit:	s
Data Type:	REAL	Access Type:	Read/Write

P 5.3.2.3 System Inertia

Set the system inertia.

Default Value:	–	Parameter Type:	Range (0 — 10000)
Parameter Number:	667	Unit:	kgm ²
Data Type:	REAL	Access Type:	Read/Write

6.6.4.3 Torque & AEO (Menu Index 5.3.3)

P 5.3.3.1 Torque Characteristic

Select the torque characteristics matching the application needs.

Default Value:	0 (Constant torque (CT))	Parameter Type:	Selection
Parameter Number:	2809	Unit:	–
Data Type:	UINT	Access Type:	Read/Write

The following are the selections for the parameter.

Selection Number	Selection Name	Selection Description
0	Constant torque (CT)	Typically used for applications where high load is present in the full speed range.
1	Variable torque (VT)	Typically used with quadratic loads like fans and centrifugal pumps.
2	Automatic Energy Optimization (AEO)	Motor magnetization is adapted to the current load. This functionality optimizes energy efficiency, but reduces dynamics to torque changes.

P 5.3.3.2 AEO Minimum Speed

Set the speed above which Automatic Energy Optimization (AEO) is active.

Default Value:	10	Parameter Type:	Range (0 — 2000)
Parameter Number:	2810	Unit:	Hz
Data Type:	REAL	Access Type:	Read/Write

P 5.3.3.3 AEO Minimum Magnetization

Set the minimum magnetization current used by Automatic Energy Optimization (AEO).

Default Value:	40	Parameter Type:	Range (0 — 100)
Parameter Number:	2811	Unit:	%
Data Type:	REAL	Access Type:	Read/Write

P 5.3.3.4 Variable Torque Zero Speed Magnetization

Set the magnetization current level at 0 speed. Used in variable torque (VT) setting.

Default Value:	66	Parameter Type:	Range (40 — 90)
Parameter Number:	8020	Unit:	%
Data Type:	REAL	Access Type:	Read/Write

6.6.5 Operation Mode (Menu Index 5.4)

6.6.5.1 Settings (Menu Index 5.4.2)

P 5.4.2.16 Operation Mode

Select the drive operation mode.

Default Value:	0 (Speed control)	Parameter Type:	Selection
Parameter Number:	2500	Unit:	–
Data Type:	UINT	Access Type:	Read/Write

The following are the selections for the parameter.

Selection Number	Selection Name	Selection Description
0	Speed control	The drive controls the motor speed.
1	Torque control	The drive controls the motor torque.
21	Process control	The drive controls a process variable based on feedback to the process controller.

P 5.4.2.20 Rotational Direction Limit

Sets the limit for directional rotation of the motor.

Default Value:	0 (Both Directions)	Parameter Type:	Selection
Parameter Number:	2501	Unit:	–
Data Type:	UINT	Access Type:	Read/Write

The following are the selections for the parameter.

Selection Number	Selection Name	Selection Description
0	Both Directions	Allow the motor to spin both clockwise and counterclockwise.
1	Clockwise Only	Allow the motor to only run in clockwise direction with a positive reference. The minimum reference is set to 0.
2	Counter Clockwise Only	The motor is only allowed to run in counterclockwise direction with a negative reference. Maximum reference is set to 0.

6.6.6 Control Places (Menu Index 5.5)

6.6.6.1 Control Places Overview

The parameters of parameter group 5.5 are used to configure the source from where the drive receives its commands, and what types of references are used. The configuration of the reference sources is part of the application controller parameterization. Commands and references are configured per operation mode of the drive (see also parameter 5.4.2.16). The Industry application software supports the following control places:

- Local control through the Control Panel
- Fieldbus control
- I/O control
- Advanced control

Advanced control allows the logical combination of 2 command sources.

The supported command logic for Advanced control is:

- Source 1
- Source 2
- AND
- OR
- NAND
- NOR
- XOR
- XNOR

The supported reference logic (except for local control) is:

- Source 1
- Source 2
- Sum
- Subtract
- Divide
- Multiply
- Maximum
- Minimum
- Toggle

The following illustration shows how control places function in the iC7 drive:

- 5.5.3.1 Settings
(Functionality settings for the control panel)
- 5.5.3.2 References
(Types of reference for speed control, torque control, and position control when controlled by the panel)
- 5.5.4.1 References
(Max. 2 reference types per Operation Mode which can be combined by logic)
- 5.5.5.1 Commands
(Selection of digital inputs for the commands Start, Start Backwards, Stop Inverse, Coast Inverse, Reversing, Reset (one per command))
- 5.5.5.2 References
(Maximum of 2 reference types per Organisation Mode. Reference types can be combined by logic)
- 5.5.6.1 Commands
(Selection of input types for the commands Start, Start Backwards, Stop Inverse, Coast inverse, Reversing, Reset (maximum of two per command, input types can be combined by logic))
- 5.5.6.2 References
(Maximum of two reference types per Operation Mode. Reference types can be combined by logic)

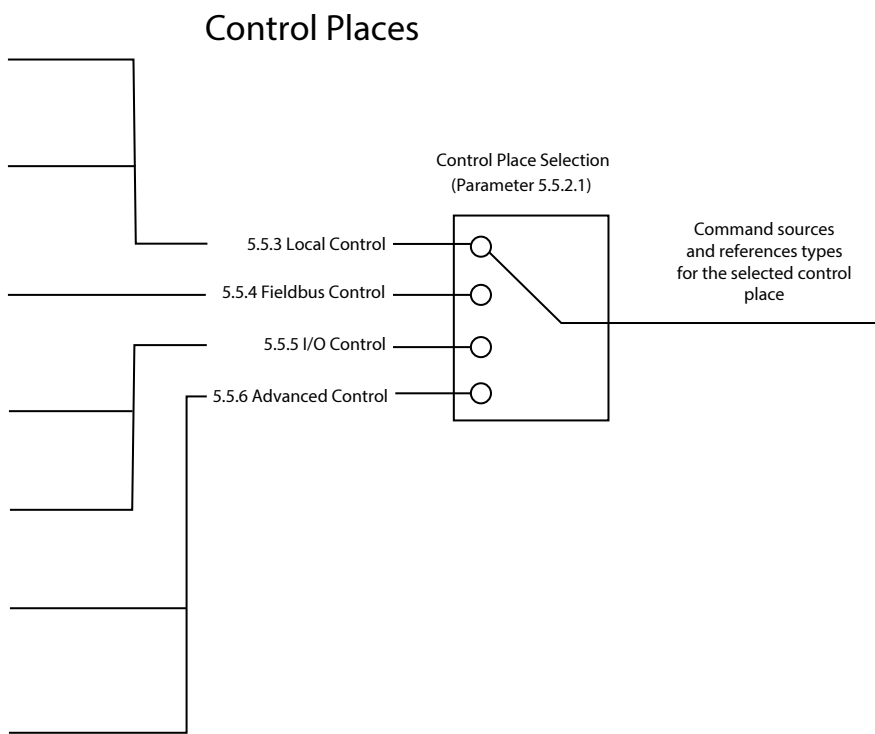

e30bm127.10

Figure 64: Control Places

6.6.6.2 Control Places Status (Menu Index 5.5.1)

P 5.5.1.1 Active Control Place

Shows the control place that controls the drive.

Default Value:	NA	Parameter Type:	Selection
Parameter Number:	113	Unit:	–
Data Type:	UINT	Access Type:	Read Only

The following are the selections for the parameter.

Selection Number	Selection Name	Selection Description
0	PC control	The drive is controlled by a software tool.
1	Local control	The drive is controlled by a connected control panel.
2	Fieldbus control	The drive is controlled via a fieldbus.
3	I/O control	The drive is controlled via I/O.
4	Advanced control	The drive is controlled via a combination of I/O and fieldbus.

P 5.5.1.2 Local Control Active Output

Select an output terminal indicating that the drive is in local control.

Default Value:	–	Parameter Type:	Selection
Parameter Number:	5178	Unit:	–
Data Type:	UINT	Access Type:	Read/Write

P 5.5.1.3 Fieldbus Control Active Output

Select an output terminal indicating that the drive is in fieldbus control.

Default Value:	–	Parameter Type:	Selection
Parameter Number:	5197	Unit:	–
Data Type:	UINT	Access Type:	Read/Write

P 5.5.1.4 I/O Control Active Output

Select an output terminal indicating that the drive is in I/O control.

Default Value:	–	Parameter Type:	Selection
Parameter Number:	5177	Unit:	–
Data Type:	UINT	Access Type:	Read/Write

P 5.5.1.5 Advanced Control Active Output

Select an output terminal indicating that the drive is in advanced control.

Default Value:	–	Parameter Type:	Selection
Parameter Number:	4727	Unit:	–
Data Type:	UINT	Access Type:	Read/Write

6.6.6.3 Control Place Settings (Menu Index 5.5.2)

P 5.5.2.1 Control Place Selection

Select the active control place.

Default Value:	4 (Advanced control)	Parameter Type:	Selection
Parameter Number:	114	Unit:	–
Data Type:	UINT	Access Type:	Read/Write

The following are the selections for the parameter.

Selection Number	Selection Name	Selection Description
1	Local control	The drive is controlled by a connected control panel.
2	Fieldbus control	The drive is controlled via a fieldbus.
3	I/O control	The drive is controlled via I/O.
4	Advanced control	The drive is controlled via a combination of I/O and fieldbus.

P 5.5.2.7 Control Place Independent Reset

Enable faults to be reset from all control places.

Default Value:	1 (Enabled)	Parameter Type:	Selection
Parameter Number:	109	Unit:	–
Data Type:	BOOL	Access Type:	Read/Write

The following are the selections for the parameter.

Selection Number	Selection Name	Selection Description
0	Disabled	Disables the function.
1	Enabled	Enables the function.

P 5.5.2.9 Alternative Control Place Selection

Select the alternative control place.

Default Value:	4 (Advanced control)	Parameter Type:	Selection
Parameter Number:	115	Unit:	–
Data Type:	UINT	Access Type:	Read/Write

The following are the selections for the parameter.

Selection Number	Selection Name	Selection Description
1	Local control	The drive is controlled by a connected control panel.
2	Fieldbus control	The drive is controlled via a fieldbus.
3	I/O control	The drive is controlled via I/O.
4	Advanced control	The drive is controlled via a combination of I/O and fieldbus.

P 5.5.2.10 Alternative Control Place Input

Select the digital input terminal for activating the alternative control place.

Default Value:	–	Parameter Type:	Selection
Parameter Number:	111	Unit:	–
Data Type:	UINT	Access Type:	Read/Write

6.6.6.4 Local Control (Menu Index 5.5.3)

6.6.6.4.1 Settings (Menu Index 5.5.3.1)

P 5.5.3.1.1 Allow Local Control Force Stop

Select whether the control panel stop button always stops the drive, regardless of the selected control place. Pressing the stop button also places the drive in local control.

Default Value:	1 (Enabled)	Parameter Type:	Selection
Parameter Number:	106	Unit:	–
Data Type:	BOOL	Access Type:	Read/Write

The following are the selections for the parameter.

Selection Number	Selection Name	Selection Description
0	Disabled	Disables the function.
1	Enabled	Enables the function.

P 5.5.3.1.2 Local Control Mode

Select restrictions of local control by the control panel.

Default Value:	0 (Allow Local Control)	Parameter Type:	Selection
Parameter Number:	107	Unit:	–
Data Type:	UINT	Access Type:	Read/Write

The following are the selections for the parameter.

Selection Number	Selection Name	Selection Description
0	Allow Local Control	Local mode from control panel is enabled.
1	Deny Local Start	Start in local mode from control panel is disabled.
2	Deny Local Control	Local mode from control panel is disabled.

P 5.5.3.1.3 Continue Operation in Local Control

Enables running state when changing to local control.

Default Value:	1 (Enabled)	Parameter Type:	Selection
Parameter Number:	108	Unit:	–
Data Type:	BOOL	Access Type:	Read/Write

The following are the selections for the parameter.

Selection Number	Selection Name	Selection Description
0	Disabled	Disables the function.
1	Enabled	Enables the function.

P 5.5.3.1.4 Local Control Stop Button Action

Select the action of the stop button in the control panel. Selecting 'Stop, Hold to Coast' will stop and coast if the stop button is pressed for 2 s.

Default Value:	2 (Stop, Hold to Coast)	Parameter Type:	Selection
Parameter Number:	110	Unit:	–
Data Type:	UINT	Access Type:	Read/Write

The following are the selections for the parameter.

Selection Number	Selection Name	Selection Description
0	Stop	Push stop button to stop the motor.
1	Coast Stop	Push stop button to coast the motor.
2	Stop, Hold to Coast	Push stop button to stop. If pressed for 2 s, motor coasts.

6.6.6.4.2 References (Menu Index 5.5.3.2)

P 5.5.3.2.1 Local Speed Reference Source

Select the speed reference source for when the drive is in local control.

Default Value:	1 (Local reference)	Parameter Type:	Selection
Parameter Number:	1912	Unit:	–
Data Type:	UINT	Access Type:	Read/Write

The following are the selections for the parameter.

Selection Number	Selection Name	Selection Description
1	Local reference	Use local reference from the control panel.
2	Fieldbus reference	Use reference from the fieldbus.
3	Reference 1 input	Use the reference from I/O reference 1.
4	Reference 2 input	Use the reference from I/O reference 2.
5	Preset reference	Use reference from the preset reference.
9	Logic Reference	Use reference from Logic.

P 5.5.3.2.2 Local Torque Reference Source

Select the torque reference source for when the drive is in local control.

Default Value:	1 (Local reference)	Parameter Type:	Selection
Parameter Number:	1925	Unit:	–
Data Type:	UINT	Access Type:	Read/Write

The following are the selections for the parameter.

Selection Number	Selection Name	Selection Description
1	Local reference	Use local reference from the control panel.
2	Fieldbus reference	Use reference from the fieldbus.
3	Reference 1 input	Use the reference from I/O reference 1.
4	Reference 2 input	Use the reference from I/O reference 2.
5	Preset reference	Use reference from the preset reference.
9	Logic Reference	Use reference from Logic.

P 5.5.3.2.3 Local Process Reference Source

Select the process control reference source for when the drive is in local control.

Default Value:	1 (Local reference)	Parameter Type:	Selection
Parameter Number:	6051	Unit:	–
Data Type:	UINT	Access Type:	Read/Write

The following are the selections for the parameter.

Selection Number	Selection Name	Selection Description
1	Local reference	Use local reference from the control panel.
2	Fieldbus reference	Use reference from the fieldbus.
3	Reference 1 input	Use the reference from I/O reference 1.
4	Reference 2 input	Use the reference from I/O reference 2.
5	Preset reference	Use reference from the preset reference.
9	Logic Reference	Use reference from Logic.

6.6.6.5 Fieldbus control (Menu Index 5.5.4)

6.6.6.5.1 References (Menu Index 5.5.4.1)

P 5.5.4.1.1 Fieldbus Speed Reference Source

Select the speed reference sources for when the drive operates in fieldbus control. Select 2 sources to combine them into 1 reference value.

Default Value:	[2,0]	Parameter Type:	Selection
Parameter Number:	1914	Unit:	–
Data Type:	UINT	Access Type:	Read/Write

The following are the selections for the parameter.

Selection Number	Selection Name	Selection Description
0	None	No source selected equals a 0 value.
2	Fieldbus reference	Use reference from the fieldbus.
3	Reference 1 input	Use the reference from I/O reference 1.
4	Reference 2 input	Use the reference from I/O reference 2.
5	Preset reference	Use reference from the preset reference.
9	Logic Reference	Use reference from Logic.

P 5.5.4.1.2 Fieldbus Speed Reference Logic

Select how to form the speed reference out of the 2 inputs when operating in fieldbus control.

Default Value:	0 (Source 1)	Parameter Type:	Selection
Parameter Number:	1911	Unit:	–
Data Type:	UINT	Access Type:	Read/Write

The following are the selections for the parameter.

Selection Number	Selection Name	Selection Description
0	Source 1	Use value from source 1 only.
1	Source 2	Use value from source 2 only.
2	Sum	Add references from source 1 and 2 together.

Selection Number	Selection Name	Selection Description
3	Subtract	Subtract source 2 from source 1.
4	Divide	Divide source 1 with source 2.
5	Multiply	Multiply source 1 with source 2.
6	Maximum	Use highest value of source 1 and source 2.
7	Minimum	Use lowest value of source 1 and source 2.
8	Toggle	Toggle between source 1 and 2 using a digital input.

P 5.5.4.1.3 Fieldbus Speed Reference Toggle Input

Select an input for toggling between the 2 speed reference sources selected, when operating in fieldbus control and toggling logic is used. A low signal selects the 1st source and high signal selects the 2nd source.

Default Value:	–	Parameter Type:	Selection
Parameter Number:	1939	Unit:	–
Data Type:	UINT	Access Type:	Read/Write

P 5.5.4.1.4 Fieldbus Torque Reference Source

Select the torque reference sources for when the drive operates in fieldbus control. Select 2 sources to combine them into 1 reference value.

Default Value:	[2,0]	Parameter Type:	Selection
Parameter Number:	1928	Unit:	–
Data Type:	UINT	Access Type:	Read/Write

The following are the selections for the parameter.

Selection Number	Selection Name	Selection Description
0	None	No source selected equals a 0 value.
2	Fieldbus reference	Use reference from the fieldbus.
3	Reference 1 input	Use the reference from I/O reference 1.
4	Reference 2 input	Use the reference from I/O reference 2.
5	Preset reference	Use reference from the preset reference.
9	Logic Reference	Use reference from Logic.

P 5.5.4.1.5 Fieldbus Torque Reference Logic

Select how to form the torque reference out of the 2 sources when operating in fieldbus control.

Default Value:	0 (Source 1)	Parameter Type:	Selection
Parameter Number:	1918	Unit:	–
Data Type:	UINT	Access Type:	Read/Write

The following are the selections for the parameter.

Selection Number	Selection Name	Selection Description
0	Source 1	Use value from source 1 only.
1	Source 2	Use value from source 2 only.
2	Sum	Add references from source 1 and 2 together.
3	Subtract	Subtract source 2 from source 1.
4	Divide	Divide source 1 with source 2.
5	Multiply	Multiply source 1 with source 2.
6	Maximum	Use highest value of source 1 and source 2.
7	Minimum	Use lowest value of source 1 and source 2.

P 5.5.4.1.6 Fieldbus Process Reference Source

Select the process control reference sources for when the drive operates in fieldbus control. Define multiple entries for combining several sources into 1 reference value.

Default Value:	[2,0]	Parameter Type:	Selection
Parameter Number:	6052	Unit:	–
Data Type:	UINT	Access Type:	Read/Write

The following are the selections for the parameter.

Selection Number	Selection Name	Selection Description
0	None	Nothing selected.
2	Fieldbus reference	Use reference from the fieldbus.
3	Reference 1 input	Use the reference from I/O reference 1.
4	Reference 2 input	Use the reference from I/O reference 2.
5	Preset reference	Use reference from the preset reference.
9	Logic Reference	Use reference from Logic.

P 5.5.4.1.7 Fieldbus Process Reference Logic

Select how to form the process control reference out of the 2 sources when operating in fieldbus control.

Default Value:	0 (Source 1)	Parameter Type:	Selection
Parameter Number:	6057	Unit:	–
Data Type:	UINT	Access Type:	Read/Write

The following are the selections for the parameter.

Selection Number	Selection Name	Selection Description
0	Source 1	Use value from source 1 only.
1	Source 2	Use value from source 2 only.
2	Sum	Add references from source 1 and 2 together.
3	Subtract	Subtract source 2 from source 1.

Selection Number	Selection Name	Selection Description
4	Divide	Divide source 1 with source 2.
5	Multiply	Multiply source 1 with source 2.
6	Maximum	Use highest value of source 1 and source 2.
7	Minimum	Use lowest value of source 1 and source 2.

6.6.6.6 I/O Control (Menu Index 5.5.5)

6.6.6.6.1 Commands (Menu Index 5.5.5.1)

P 5.5.5.1.1 Start Input

Select the digital input for the start command.

Default Value:	–	Parameter Type:	Selection
Parameter Number:	200	Unit:	–
Data Type:	UINT	Access Type:	Read/Write

P 5.5.5.1.2 Start Backward Input

Select the digital input for the start command in the backward direction.

Default Value:	–	Parameter Type:	Selection
Parameter Number:	210	Unit:	–
Data Type:	UINT	Access Type:	Read/Write

P 5.5.5.1.3 Stop Inverse Input

Select the digital input for the inverted stop command.

Default Value:	–	Parameter Type:	Selection
Parameter Number:	201	Unit:	–
Data Type:	UINT	Access Type:	Read/Write

P 5.5.5.1.4 Coast Inverse Input

Select the digital input for the inverted coast command.

Default Value:	–	Parameter Type:	Selection
Parameter Number:	202	Unit:	–
Data Type:	UINT	Access Type:	Read/Write

P 5.5.5.1.5 Reversing Input

Select the digital input for inverting the reference signal. The reverse command does not provide a start signal.

Default Value:	–	Parameter Type:	Selection
Parameter Number:	204	Unit:	–
Data Type:	UINT	Access Type:	Read/Write

P 5.5.5.1.6 Reset Input

Select the digital input for resetting faults.

Default Value:	–	Parameter Type:	Selection
Parameter Number:	203	Unit:	–
Data Type:	UINT	Access Type:	Read/Write

P 5.5.5.1.8 Start Signal Mode

Select the mode of the start signal.

Default Value:	0 (State High Start)	Parameter Type:	Selection
Parameter Number:	211	Unit:	–
Data Type:	UINT	Access Type:	Read/Write

The following are the selections for the parameter.

Selection Number	Selection Name	Selection Description
0	State High Start	Start command remains as long as input is true.
1	Rising Edge Start	Start command is set when input becomes true and remains latched until a stop command is given.
2	High Pulse Start	Start command is set when input becomes true and remains latched until stop command is given.

6.6.6.2 References (Menu Index 5.5.5.2)

P 5.5.5.2.1 I/O Speed Reference Source

Select the speed reference sources for when the drive operates in I/O control. Select 2 sources to combine them into 1 reference value.

Default Value:	[3,0]	Parameter Type:	Selection
Parameter Number:	1913	Unit:	–
Data Type:	UINT	Access Type:	Read/Write

The following are the selections for the parameter.

Selection Number	Selection Name	Selection Description
0	None	No source selected equals a 0 value.
2	Fieldbus reference	Use reference from the fieldbus.
3	Reference 1 input	Use the reference from I/O reference 1.
4	Reference 2 input	Use the reference from I/O reference 2.
5	Preset reference	Use reference from the preset reference.
9	Logic Reference	Use reference from Logic.

P 5.5.5.2.2 I/O Speed Reference Logic

Select how to form the speed reference out of the 2 sources when operating in I/O control.

Default Value:	0 (Source 1)	Parameter Type:	Selection
Parameter Number:	1910	Unit:	–

Data Type:	UINT	Access Type:	Read/Write
-------------------	------	---------------------	------------

The following are the selections for the parameter.

Selection Number	Selection Name	Selection Description
0	Source 1	Use value from source 1 only.
1	Source 2	Use value from source 2 only.
2	Sum	Add references from source 1 and 2 together.
3	Subtract	Subtract source 2 from source 1.
4	Divide	Divide source 1 with source 2.
5	Multiply	Multiply source 1 with source 2.
6	Maximum	Use highest value of source 1 and source 2.
7	Minimum	Use lowest value of source 1 and source 2.
8	Toggle	Toggle between source 1 and 2 using a digital input.

P 5.5.5.2.3 I/O Speed Reference Toggle Input

Select an input for toggling between the 2 speed reference sources selected, when operating in I/O control and toggling logic is used. A low signal selects the 1st source and high signal selects the 2nd source.

Default Value:	–	Parameter Type:	Selection
Parameter Number:	1940	Unit:	–
Data Type:	UINT	Access Type:	Read/Write

P 5.5.5.2.4 I/O Torque Reference Source

Select the torque reference sources for when the drive operates in I/O control. Select 2 sources to combine them into 1 reference value.

Default Value:	[3,0]	Parameter Type:	Selection
Parameter Number:	1927	Unit:	–
Data Type:	UINT	Access Type:	Read/Write

The following are the selections for the parameter.

Selection Number	Selection Name	Selection Description
0	None	No source selected equals a 0 value.
2	Fieldbus reference	Use reference from the fieldbus.
3	Reference 1 input	Use the reference from I/O reference 1.
4	Reference 2 input	Use the reference from I/O reference 2.
5	Preset reference	Use reference from the preset reference.
9	Logic Reference	Use reference from Logic.

P 5.5.5.2.5 I/O Torque Reference Logic

Select how to form the torque reference out of the 2 sources when operating in I/O control.

Default Value:	0 (Source 1)	Parameter Type:	Selection
Parameter Number:	1917	Unit:	–
Data Type:	UINT	Access Type:	Read/Write

The following are the selections for the parameter.

Selection Number	Selection Name	Selection Description
0	Source 1	Use value from source 1 only.
1	Source 2	Use value from source 2 only.
2	Sum	Add references from source 1 and 2 together.
3	Subtract	Subtract source 2 from source 1.
4	Divide	Divide source 1 with source 2.
5	Multiply	Multiply source 1 with source 2.
6	Maximum	Use highest value of source 1 and source 2.
7	Minimum	Use lowest value of source 1 and source 2.

P 5.5.5.2.6 I/O Process Reference Source

Select the process control reference sources for when the drive operates in I/O control. Select 2 sources to combine them into 1 reference value.

Default Value:	[3,0]	Parameter Type:	Selection
Parameter Number:	6055	Unit:	–
Data Type:	UINT	Access Type:	Read/Write

The following are the selections for the parameter.

Selection Number	Selection Name	Selection Description
0	None	Nothing selected.
2	Fieldbus reference	Use reference from the fieldbus.
3	Reference 1 input	Use the reference from I/O reference 1.
4	Reference 2 input	Use the reference from I/O reference 2.
5	Preset reference	Use reference from the preset reference.
9	Logic Reference	Use reference from Logic.

P 5.5.5.2.7 I/O Process Reference Logic

Select how to form the process control reference out of the 2 sources when operating in I/O control.

Default Value:	0 (Source 1)	Parameter Type:	Selection
Parameter Number:	6059	Unit:	–
Data Type:	UINT	Access Type:	Read/Write

The following are the selections for the parameter.

Selection Number	Selection Name	Selection Description
0	Source 1	Use value from source 1 only.
1	Source 2	Use value from source 2 only.
2	Sum	Add references from source 1 and 2 together.
3	Subtract	Subtract source 2 from source 1.
4	Divide	Divide source 1 with source 2.
5	Multiply	Multiply source 1 with source 2.
6	Maximum	Use highest value of source 1 and source 2.
7	Minimum	Use lowest value of source 1 and source 2.

6.6.6.7 Advanced control (Menu Index 5.5.6)

6.6.6.7.1 Commands (Menu Index 5.5.6.1)

P 5.5.6.1.1 Advanced Start Input

Select inputs for starting in the forward direction when operating in advanced control.

Default Value:	–	Parameter Type:	Selection
Parameter Number:	4722	Unit:	–
Data Type:	UINT	Access Type:	Read/Write

P 5.5.6.1.2 Advanced Start Logic

Select the combination logic for the start command of advanced control.

Default Value:	3 (OR)	Parameter Type:	Selection
Parameter Number:	1933	Unit:	–
Data Type:	UINT	Access Type:	Read/Write

The following are the selections for the parameter.

Selection Number	Selection Name	Selection Description
0	Source 1	Use value from source 1 only.
1	Source 2	Use value from source 2 only.
2	AND	Logically AND source 1 and 2.
3	OR	Logically OR source 1 and 2.
4	NAND	Logically NAND source 1 and 2.
5	NOR	Logically NOR source 1 and 2.
6	XOR	Logically XOR source 1 and 2.
7	XNOR	Logically XNOR source 1 and 2.

P 5.5.6.1.3 Advanced Start Backward Input

Select inputs for starting in the backward direction when operating in advanced control.

Default Value:	–	Parameter Type:	Selection
-----------------------	---	------------------------	-----------

Parameter Number: 4725	Unit: –
Data Type: UINT	Access Type: Read/Write

P 5.5.6.1.4 Advanced Start Backward Logic

Select the combination logic for the start-backward command of advanced control.

Default Value: 0 (Source 1)	Parameter Type: Selection
Parameter Number: 1934	Unit: –
Data Type: UINT	Access Type: Read/Write

The following are the selections for the parameter.

Selection Number	Selection Name	Selection Description
0	Source 1	Use value from source 1 only.
1	Source 2	Use value from source 2 only.
2	AND	Logically AND source 1 and 2.
3	OR	Logically OR source 1 and 2.
4	NAND	Logically NAND source 1 and 2.
5	NOR	Logically NOR source 1 and 2.
6	XOR	Logically XOR source 1 and 2.
7	XNOR	Logically XNOR source 1 and 2.

P 5.5.6.1.5 Advanced Stop Inverse Input

Select inputs for stopping when operating in advanced control. False means the drive is stopped.

Default Value: –	Parameter Type: Selection
Parameter Number: 4723	Unit: –
Data Type: UINT	Access Type: Read/Write

P 5.5.6.1.6 Advanced Stop Inverse Logic

Select the combination logic for the stop command of advanced control.

Default Value: 0 (Source 1)	Parameter Type: Selection
Parameter Number: 1935	Unit: –
Data Type: UINT	Access Type: Read/Write

The following are the selections for the parameter.

Selection Number	Selection Name	Selection Description
0	Source 1	Use value from source 1 only.
1	Source 2	Use value from source 2 only.
2	AND	Logically AND source 1 and 2.
3	OR	Logically OR source 1 and 2.

Selection Number	Selection Name	Selection Description
4	NAND	Logically NAND source 1 and 2.
5	NOR	Logically NOR source 1 and 2.
6	XOR	Logically XOR source 1 and 2.
7	XNOR	Logically XNOR source 1 and 2.

P 5.5.6.1.7 Advanced Coast Inverse Input

Select inputs for the coast when operating in advanced control. False means the drive is coasted.

Default Value:	–	Parameter Type:	Selection
Parameter Number:	4724	Unit:	–
Data Type:	UINT	Access Type:	Read/Write

P 5.5.6.1.8 Advanced Coast Inverse Logic

Select the combination logic for the inverted coast command of advanced control.

Default Value:	0 (Source 1)	Parameter Type:	Selection
Parameter Number:	1936	Unit:	–
Data Type:	UINT	Access Type:	Read/Write

The following are the selections for the parameter.

Selection Number	Selection Name	Selection Description
0	Source 1	Use value from source 1 only.
1	Source 2	Use value from source 2 only.
2	AND	Logically AND source 1 and 2.
3	OR	Logically OR source 1 and 2.
4	NAND	Logically NAND source 1 and 2.
5	NOR	Logically NOR source 1 and 2.
6	XOR	Logically XOR source 1 and 2.
7	XNOR	Logically XNOR source 1 and 2.

P 5.5.6.1.9 Advanced Reversing Input

Select inputs for inverting the reference signal when operating in advanced control. The reverse command does not provide a start signal.

Default Value:	–	Parameter Type:	Selection
Parameter Number:	4730	Unit:	–
Data Type:	UINT	Access Type:	Read/Write

P 5.5.6.1.10 Advanced Reverse Logic

Select the combination logic for the reverse command of advanced control.

Default Value:	3 (OR)	Parameter Type:	Selection
-----------------------	--------	------------------------	-----------

Parameter Number: 1937	Unit: –
Data Type: UINT	Access Type: Read/Write

The following are the selections for the parameter.

Selection Number	Selection Name	Selection Description
0	Source 1	Use value from source 1 only.
1	Source 2	Use value from source 2 only.
2	AND	Logically AND source 1 and 2.
3	OR	Logically OR source 1 and 2.
4	NAND	Logically NAND source 1 and 2.
5	NOR	Logically NOR source 1 and 2.
6	XOR	Logically XOR source 1 and 2.
7	XNOR	Logically XNOR source 1 and 2.

P 5.5.6.1.11 Advanced Reset Input

Select inputs for resetting faults when operating in advanced control.

Default Value: –	Parameter Type: Selection
Parameter Number: 4731	Unit: –
Data Type: UINT	Access Type: Read/Write

P 5.5.6.1.13 Advanced Start Mode

Select the starting logic for advanced control.

Default Value: 0 (State High Start)	Parameter Type: Selection
Parameter Number: 4726	Unit: –
Data Type: UINT	Access Type: Read/Write

The following are the selections for the parameter.

Selection Number	Selection Name	Selection Description
0	State High Start	Start command remains as long as input is true.
1	Rising Edge Start	Start command is set when input becomes true and remains latched until a stop command is given.
2	High Pulse Start	Start command is set when input becomes true and remains latched until stop command is given.

P 5.5.6.1.15 Fieldbus CTW Feature Bits

Enables non-control-place-dependent control word bits to be active in advanced control place.

Default Value: 1 (Enabled)	Parameter Type: Selection
Parameter Number: 4627	Unit: –

Data Type:	BOOL	Access Type:	Read/Write
-------------------	------	---------------------	------------

The following are the selections for the parameter.

Selection Number	Selection Name	Selection Description
0	Disabled	Disables the function.
1	Enabled	Enables the function.

6.6.6.7.2 References (Menu Index 5.5.6.2)

P 5.5.6.2.1 Adv. Speed Reference Source

Select the speed reference sources for when the drive operates in advanced control. Select 2 sources to combine them into 1 reference value.

Default Value:	[2,3]	Parameter Type:	Selection
Parameter Number:	1915	Unit:	–
Data Type:	UINT	Access Type:	Read/Write

The following are the selections for the parameter.

Selection Number	Selection Name	Selection Description
0	None	No source selected equals a 0 value.
2	Fieldbus reference	Use reference from the fieldbus.
3	Reference 1 input	Use the reference from I/O reference 1.
4	Reference 2 input	Use the reference from I/O reference 2.
5	Preset reference	Use reference from the preset reference.
9	Logic Reference	Use reference from Logic.

P 5.5.6.2.2 Adv. Speed Reference Logic

Select how to form the speed reference out of the 2 sources when operating in advanced control.

Default Value:	2 (Sum)	Parameter Type:	Selection
Parameter Number:	1916	Unit:	–
Data Type:	UINT	Access Type:	Read/Write

The following are the selections for the parameter.

Selection Number	Selection Name	Selection Description
0	Source 1	Use value from source 1 only.
1	Source 2	Use value from source 2 only.
2	Sum	Add references from source 1 and 2 together.
3	Subtract	Subtract source 2 from source 1.
4	Divide	Divide source 1 with source 2.
5	Multiply	Multiply source 1 with source 2.

Selection Number	Selection Name	Selection Description
6	Maximum	Use highest value of source 1 and source 2.
7	Minimum	Use lowest value of source 1 and source 2.
8	Toggle	Toggle between source 1 and 2 using a digital input.

P 5.5.6.2.3 Adv. Speed Reference Toggle Input

Select an input for toggling between the 2 speed reference sources selected, when operating in advanced control and toggling logic is used. A low signal selects the 1st source and high signal selects the 2nd source.

Default Value:	–	Parameter Type:	Selection
Parameter Number:	1941	Unit:	–
Data Type:	UINT	Access Type:	Read/Write

P 5.5.6.2.4 Adv. Torque Reference Source

Select the torque reference sources for when the drive operates in advanced control. Select 2 sources to combine them into 1 reference value.

Default Value:	[2,0]	Parameter Type:	Selection
Parameter Number:	1929	Unit:	–
Data Type:	UINT	Access Type:	Read/Write

The following are the selections for the parameter.

Selection Number	Selection Name	Selection Description
0	None	No source selected equals a 0 value.
2	Fieldbus reference	Use reference from the fieldbus.
3	Reference 1 input	Use the reference from I/O reference 1.
4	Reference 2 input	Use the reference from I/O reference 2.
5	Preset reference	Use reference from the preset reference.
9	Logic Reference	Use reference from Logic.

P 5.5.6.2.5 Adv. Torque Reference Logic

Select how to form the torque reference out of the 2 inputs when operating in advanced control.

Default Value:	0 (Source 1)	Parameter Type:	Selection
Parameter Number:	1919	Unit:	–
Data Type:	UINT	Access Type:	Read/Write

The following are the selections for the parameter.

Selection Number	Selection Name	Selection Description
0	Source 1	Use value from source 1 only.
1	Source 2	Use value from source 2 only.

Selection Number	Selection Name	Selection Description
2	Sum	Add references from source 1 and 2 together.
3	Subtract	Subtract source 2 from source 1.
4	Divide	Divide source 1 with source 2.
5	Multiply	Multiply source 1 with source 2.
6	Maximum	Use highest value of source 1 and source 2.
7	Minimum	Use lowest value of source 1 and source 2.

P 5.5.6.2.6 Adv. Process Reference Source

Select the process control reference sources for when the drive operates in advanced control. Define multiple entries for combining several sources into 1 reference value.

Default Value:	[2,3]	Parameter Type:	Selection
Parameter Number:	6054	Unit:	–
Data Type:	UINT	Access Type:	Read/Write

The following are the selections for the parameter.

Selection Number	Selection Name	Selection Description
0	None	Nothing selected.
2	Fieldbus reference	Use reference from the fieldbus.
3	Reference 1 input	Use the reference from I/O reference 1.
4	Reference 2 input	Use the reference from I/O reference 2.
5	Preset reference	Use reference from the preset reference.
9	Logic Reference	Use reference from Logic.

P 5.5.6.2.7 Adv. Process Reference Logic

Select how to form the process control reference out of the 2 inputs when operating in advanced control.

Default Value:	2 (Sum)	Parameter Type:	Selection
Parameter Number:	6045	Unit:	–
Data Type:	UINT	Access Type:	Read/Write

The following are the selections for the parameter.

Selection Number	Selection Name	Selection Description
0	Source 1	Use value from source 1 only.
1	Source 2	Use value from source 2 only.
2	Sum	Add references from source 1 and 2 together.
3	Subtract	Subtract source 2 from source 1.
4	Divide	Divide source 1 with source 2.
5	Multiply	Multiply source 1 with source 2.

Selection Number	Selection Name	Selection Description
6	Maximum	Use highest value of source 1 and source 2.
7	Minimum	Use lowest value of source 1 and source 2.

6.6.7 Start Settings (Menu Index 5.6)

6.6.7.1 Start Settings Overview

The application software provides the possibility to configure a DC start before entering normal motor control, for purposes of motor pre-heating, pre-magnetization, DC holding, or a start delay.

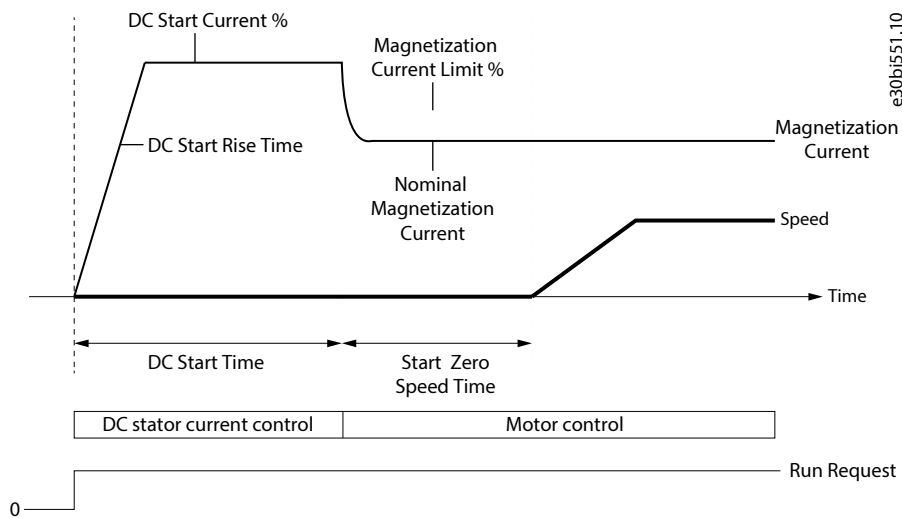

Figure 65: Induction Motor Start from Zero Speed with DC Start and Start Zero Speed Time > 0

DC start is configured using 3 parameters, [5.6.2.3 DC Start Current %](#), [5.6.2.1 DC Start Time](#), and [5.6.2.2 DC Start Rise Time](#).

By default, DC start is disabled by setting parameter [5.6.2.1 DC Start Time](#) to 0. The following illustration shows an example of starting an induction at zero speed.

DC start is also used as a start delay by setting parameter [5.6.2.1 DC Start Time](#) to the desired delay time and [5.6.2.3 DC Start Current %](#) to 0.

DC start is only applied when starting at zero speed, or when parameter [5.6.1.2 Enable Flying Start](#) is set to 0 [Disable] and motor back-emf voltage is not detected.

Synchronous motor control start settings

DC start is also possible from zero speed with synchronous motor control.

The following illustration shows a zero speed example with DC start and initial position handling as rotor angle detection. To set the initial position handling to rotor angle detection, set parameter [5.6.3.1 Sync. Motor Start Mode](#) to 0 [Rotor angle detection].

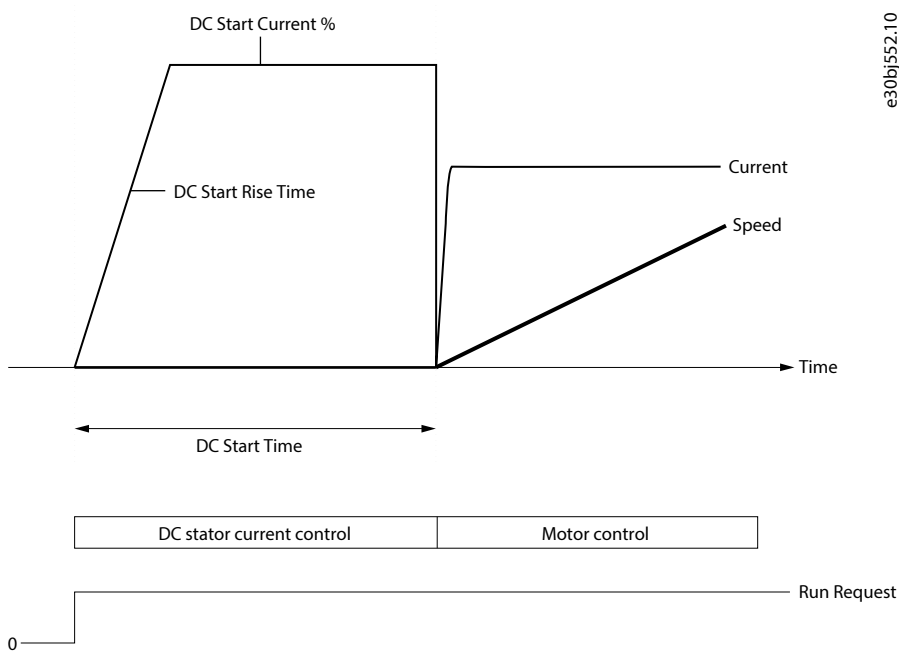

Figure 66: Synchronous Motor Start from Zero Speed with DC Start

As an alternative to rotor angle detection for a synchronous motor, it is possible to set the initial position handling as rotor angle parking by setting parameter 5.6.3.1 *Sync. Motor Start Mode* to 1 [Rotor angle parking]. This option forces the motor shaft to move to a fixed position defined by the parameter 5.6.3.5 *Sync. Motor Parking Angle Reference*, before ramp release.

Synchronous motor start from zero speed with DC-Start and parking is shown in the following illustration.

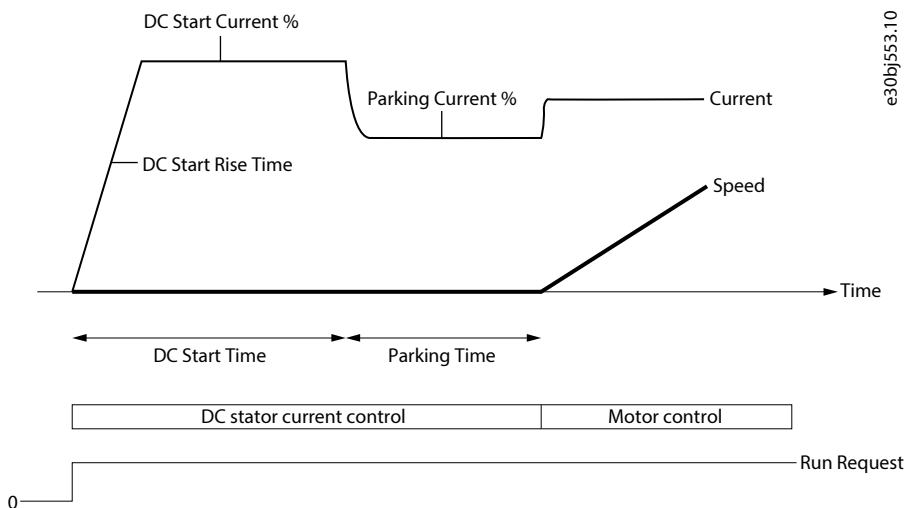

Figure 67: Synchronous Motor Start from Zero Speed with DC Start and Parking

6.6.7.2 General Settings (Menu Index 5.6.1)

P 5.6.1.1 Magnetization Time

Set a delay to magnetize the motor or synchronize parallel motors before starting ramping. Set to -1 for automatic calculation.

Default Value:	-1	Parameter Type:	Range (-1 — 10000)
Parameter Number:	2328	Unit:	s
Data Type:	REAL	Access Type:	Read/Write

P 5.6.1.2 Flying Start

Enables a flying start. The drive will detect its current speed at the moment the start signal is given, and start to ramp towards the given reference.

Default Value:	False	Parameter Type:	Selection
Parameter Number:	4025	Unit:	–
Data Type:	BOOL	Access Type:	Read/Write

The following are the selections for the parameter.

Selection Number	Selection Name	Selection Description
0	Disabled	Disables the function.
1	Enabled	Enables the function.

P 5.6.1.5 Run Enable Input

Select an input enabling the drive to run.

Default Value:	–	Parameter Type:	Selection
Parameter Number:	103	Unit:	–
Data Type:	UINT	Access Type:	Read/Write

P 5.6.1.8 Enable Start Forward Input

Select the digital input for the Start Enable command with a positive reference. If this parameter is not active, drive is stopped while reference is positive.

Default Value:	–	Parameter Type:	Selection
Parameter Number:	1601	Unit:	–
Data Type:	UINT	Access Type:	Read/Write

Enable Start Forward and Enable Start Backward make it possible to define end stop switches for the operation of the motor. The motor cannot keep running past the end switch.

This function is not a rotational direction prevention. It applies a stop command if start is given with the reference going the wrong way. Both speed and torque directions can be used.

This function works similarly to Run enable, in the sense that if either parameter is not active, the start command is suppressed in that direction.

P 5.6.1.9 Enable Start Backward Input

Select the digital input for the Start Enable command with a negative reference. If this parameter is not active, the drive is stopped while reference is negative.

Default Value:	–	Parameter Type:	Selection
Parameter Number:	1602	Unit:	–
Data Type:	UINT	Access Type:	Read/Write

6.6.7.3 DC Start (Menu Index 5.6.2)

P 5.6.2.1 DC Start Time

Set the duration of the current injection during DC start.

Default Value:	–	Parameter Type:	Range (0 — 10000)
Parameter Number:	2264	Unit:	s
Data Type:	REAL	Access Type:	Read/Write

P 5.6.2.2 DC Start Current Rise Time

Set the time to ramp the current from 0 to the specified injection level.

Default Value:	–	Parameter Type:	Range (0 — 100)
Parameter Number:	2265	Unit:	s
Data Type:	REAL	Access Type:	Read/Write

P 5.6.2.3 DC Start Current

Set the DC current in % of nominal motor current. This current is injected during the DC start time.

Default Value:	–	Parameter Type:	Range (0 — 1000)
Parameter Number:	2263	Unit:	%
Data Type:	REAL	Access Type:	Read/Write

6.6.7.4 Synchronous Motor Start (Menu Index 5.6.3)

P 5.6.3.1 Sync. Motor Start Mode

Set the synchronous motor initial position handling.

Default Value:	1 (Rotor angle detection)	Parameter Type:	Selection
Parameter Number:	2322	Unit:	–
Data Type:	UINT	Access Type:	Read/Write

The following are the selections for the parameter.

Selection Number	Selection Name	Selection Description
0	Disabled	Drive will not try to obtain motor angle.
1	Rotor angle detection	The drive will force the motor to be at the angle set as motor parking angle.
2	Rotor angle parking	The drive will force the motor to be at the angle set as motor parking angle.

P 5.6.3.2 Sync. Motor Detection Current

Set the rotor angle detection gain in % of the nominal motor current.

Default Value:	150	Parameter Type:	Range (0 — 200)
Parameter Number:	2323	Unit:	%
Data Type:	REAL	Access Type:	Read/Write

P 5.6.3.3 Sync. Motor Parking Time

Set the duration of the rotor parking.

Default Value:	3	Parameter Type:	Range (0 — 10000)
Parameter Number:	2324	Unit:	s
Data Type:	REAL	Access Type:	Read/Write

P 5.6.3.4 Sync. Motor Parking Current

Set the rotor angle parking current in % of the nominal motor current.

Default Value:	100	Parameter Type:	Range (0 — 1000)
Parameter Number:	2325	Unit:	%
Data Type:	REAL	Access Type:	Read/Write

P 5.6.3.5 Sync. Motor Parking Angle

Set the electrical parking angle for the rotor.

Default Value:	–	Parameter Type:	Range (0 — 360)
Parameter Number:	2326	Unit:	°
Data Type:	REAL	Access Type:	Read/Write

6.6.8 Stop Settings (Menu Index 5.7)

6.6.8.1 Stop Settings Overview

DC braking

The application software enables configuration of DC braking for induction motor control.

By default, the DC brake is disabled and parameter *5.6.2.1 DC Start Time* is set to 0.

The following settings can be configured:

- Speed at which DC braking starts by setting the required speed with parameter *5.7.2.3 DC Brake Speed*.
- Percentage of the brake current to be applied to the motor with parameter *5.7.2.2 DC Brake Current*.
- Duration for which the DC brake is active for a DC-braking current injection with parameter *5.7.2.1 DC-Brake Time*.

The following illustration shows a DC-braking scenario.

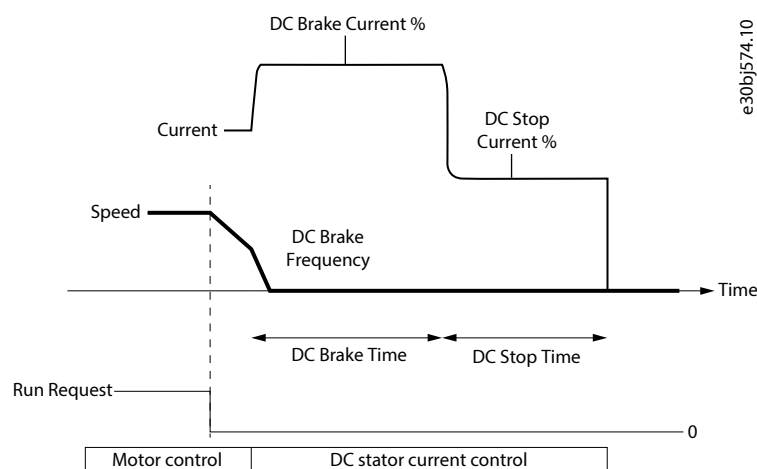

Figure 68: DC Braking and DC Stop

DC stop and stop delay

Besides the DC brake, the application software allows the configuring of DC stop, which can be used for DC hold or magnetization purposes. DC stop is configured with parameters **5.7.2.5 DC Stop Current %** and **5.7.2.4 DC Stop Time**. By default, DC stop is disabled and the parameter **5.7.2.4 DC Stop Time** is set to 0.

DC stop is always applied at zero speed and as the last activity before the drive begins to coast.

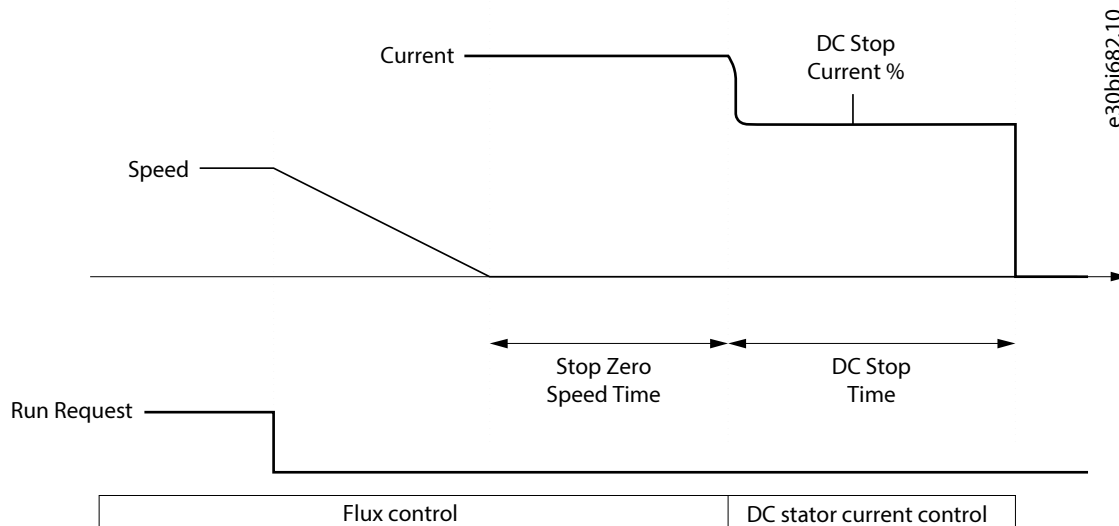

Figure 69: DC Stop and Stop Delay

When both parameters **5.7.1.1 Stop Zero Speed Time** and **5.7.2.4 DC Stop Time** are set to -1, then the parameter **5.7.1.1 Stop Zero Speed Time** has priority.

To introduce stop delay, use parameter **5.7.1.1 Stop Zero Speed Time**. By default, stop delay is disabled and parameter **5.7.1.1 Stop Zero Speed Time** is set to 0. The parameter defines the duration from reaching 0 speed to the time when the drive stops modulating or continues with DC stop. During the stop delay duration, the drive remains in run mode, modulates, and reacts to load changes.



NOTE: When the drive is configured for DC braking, the parameter **5.7.1.1 Stop Zero Speed Time** has no effect.

6.6.8.2 Settings (Menu Index 5.7.1)

P 5.7.1.1 Stop Zero Speed Time

Set the time that motor control stays active after reaching 0 speed. The value -1 means indefinitely.

Default Value:	-	Parameter Type:	Range (-1 — 10000)
Parameter Number:	2331	Unit:	s
Data Type:	REAL	Access Type:	Read/Write

P 5.7.1.3 Torque Ramp Down Time

Set the time for ramping down the remaining torque after reaching standstill.

Default Value:	-	Parameter Type:	Range (0 — 10000)
Parameter Number:	2336	Unit:	s
Data Type:	REAL	Access Type:	Read/Write

P 5.7.1.4 Zero-speed Detection Level

Set the speed that is considered standstill.

Default Value:	0.2	Parameter Type:	Range (0 — 2)
Parameter Number:	2339	Unit:	Hz
Data Type:	REAL	Access Type:	Read/Write

P 5.7.1.5 Zero-speed Detection Delay

Set the time that the speed must be below zero-speed detection level before standstill is detected.

Default Value:	0.02	Parameter Type:	Range (0 — 2)
Parameter Number:	2356	Unit:	s
Data Type:	REAL	Access Type:	Read/Write

6.6.8.3 DC Injection (Menu Index 5.7.2)

P 5.7.2.1 DC-brake Time

Set the duration for a DC braking current injection.

Default Value:	–	Parameter Type:	Range (0 — 10000)
Parameter Number:	2267	Unit:	s
Data Type:	REAL	Access Type:	Read/Write

P 5.7.2.2 DC-brake Current

Set the DC braking current in % of nominal motor current.

Default Value:	–	Parameter Type:	Range (0 — 1000)
Parameter Number:	2266	Unit:	%
Data Type:	REAL	Access Type:	Read/Write

P 5.7.2.3 DC-brake Speed

Set the speed below which DC braking is activated.

Default Value:	–	Parameter Type:	Range (0 — *)
Parameter Number:	2268	Unit:	Hz
Data Type:	REAL	Access Type:	Read/Write

P 5.7.2.4 DC Stop Time

Set the DC stopping injection duration. The value -1 means indefinitely.

Default Value:	–	Parameter Type:	Range (-1 — 10000)
Parameter Number:	2320	Unit:	s
Data Type:	REAL	Access Type:	Read/Write

P 5.7.2.5 DC Stop Current

Set the DC stopping current in % of nominal motor current. Applied after the drive has reached standstill.

Default Value:	–	Parameter Type:	Range (0 — 1000)
Parameter Number:	2321	Unit:	%
Data Type:	REAL	Access Type:	Read/Write

6.6.8.4 Quick Stop (Menu Index 5.7.3)

P 5.7.3.1 Quick Stop Inverse Input

Select an input terminal for activating the Quick Stop Inverse function.

Default Value:	–	Parameter Type:	Selection
Parameter Number:	212	Unit:	–
Data Type:	UINT	Access Type:	Read/Write

P 5.7.3.2 Quick Stop Ramp Time

Set the deceleration time for the quick stop ramp.

Default Value:	1	Parameter Type:	Range (0 — 10000)
Parameter Number:	1129	Unit:	s
Data Type:	REAL	Access Type:	Read/Write

6.6.8.5 AC Brake (Menu Index 5.7.4)

P 5.7.4.1 AC Brake

Enables the AC Brake.

Default Value:	False	Parameter Type:	Selection
Parameter Number:	4026	Unit:	–
Data Type:	BOOL	Access Type:	Read/Write

The following are the selections for the parameter.

Selection Number	Selection Name	Selection Description
0	Disabled	Disables the function.
1	Enabled	Enables the function.

P 5.7.4.2 AC-brake Voltage Control Kp

Set the scaling of the proportional gain of the AC-brake controller.

Default Value:	100	Parameter Type:	Range (0 — 500)
Parameter Number:	4027	Unit:	%
Data Type:	REAL	Access Type:	Read/Write

P 5.7.4.3 AC-brake Voltage Control Ti

Set the scaling of the integral time of the AC-brake controller.

Default Value:	100	Parameter Type:	Range (0 — 500)
Parameter Number:	4028	Unit:	%
Data Type:	REAL	Access Type:	Read/Write

P 5.7.4.4 AC-brake Current

Set the maximum allowed motor current in % of nominal motor current when AC brake is enabled.

Default Value:	100	Parameter Type:	Range (0 — 150)
Parameter Number:	4057	Unit:	%
Data Type:	REAL	Access Type:	Read/Write

6.6.9 Speed Control (Menu Index 5.8)

6.6.9.1 Speed Control Overview

Parameter group **5.8 Speed Control** contains the settings and the readout values related to the speed controller.

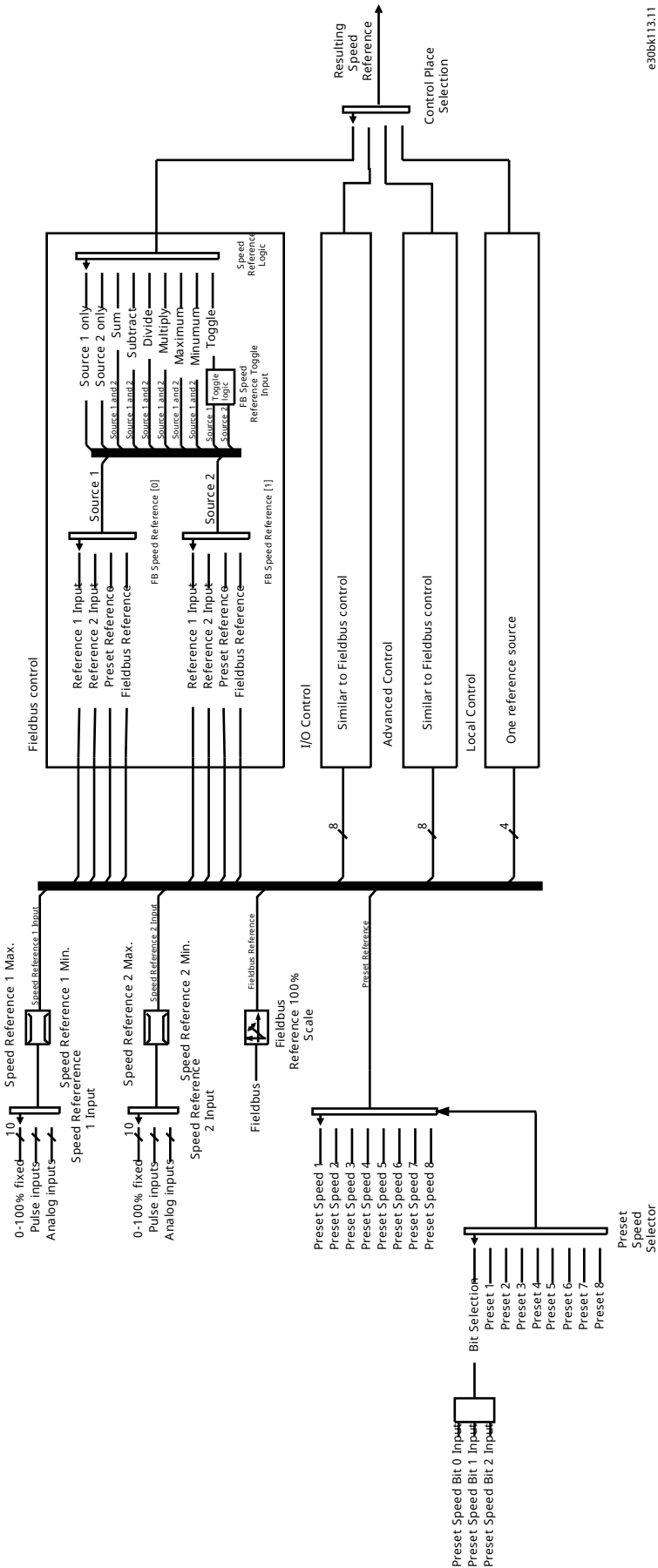

e30bkt13.11

Figure 70: Reference Handling for Speed Control

6.6.9.2 Speed Control Status (Menu Index 5.8.1)

P 5.8.1.2 Motor Speed

Shows the actual motor speed.

Default Value:	NA	Parameter Type:	Range (* — *)
Parameter Number:	9011	Unit:	Hz
Data Type:	REAL	Access Type:	Read Only

P 5.8.1.3 Output Frequency

Shows the output frequency.

Default Value:	NA	Parameter Type:	Range (* — *)
Parameter Number:	9015	Unit:	Hz
Data Type:	REAL	Access Type:	Read Only

P 5.8.1.4 Feedback Speed

Shows the feedback speed.

Default Value:	NA	Parameter Type:	Range (-10000 — 10000)
Parameter Number:	9007	Unit:	rpm
Data Type:	REAL	Access Type:	Read Only

P 5.8.1.5 Feedback Electrical Angle

Shows the feedback device angle in the electrical domain. Its value is needed for manually tuning the feedback angle offset.

Default Value:	NA	Parameter Type:	Range (0 — 360)
Parameter Number:	9016	Unit:	°
Data Type:	REAL	Access Type:	Read Only

P 5.8.1.6 Speed Error

Shows the difference between speed reference after ramp and motor speed.

Default Value:	NA	Parameter Type:	Range (* — *)
Parameter Number:	4023	Unit:	Hz
Data Type:	REAL	Access Type:	Read Only

P 5.8.1.7 Speed Reference

Shows the speed reference.

Default Value:	NA	Parameter Type:	Range (-2000 — 2000)
Parameter Number:	1718	Unit:	Hz
Data Type:	REAL	Access Type:	Read/Write

P 5.8.1.8 Speed Reference Before Ramp

Shows the value of speed reference before the ramp generator.

Default Value:	NA	Parameter Type:	Range (-2000 — 2000)
-----------------------	----	------------------------	----------------------

Parameter Number: 6049	Unit: Hz
Data Type: REAL	Access Type: Read Only

P 5.8.1.9 Speed Reference After Ramp

Shows the value of the speed reference after the ramp generator.

Default Value: NA	Parameter Type: Range (* — *)
Parameter Number: 6150	Unit: Hz
Data Type: REAL	Access Type: Read Only

P 5.8.1.10 Final Speed Reference

Shows the value of the speed reference before feeding it to the speed controller.

Default Value: NA	Parameter Type: Range (* — *)
Parameter Number: 6151	Unit: Hz
Data Type: REAL	Access Type: Read Only

P 5.8.1.11 Control Panel Speed Reference

Shows the value of the speed reference given from the control panel.

Default Value: NA	Parameter Type: Range (* — *)
Parameter Number: 6153	Unit: Hz
Data Type: REAL	Access Type: Read/Write

P 5.8.1.12 Absolute Output Frequency Output

Select an output terminal for the output frequency scaled between 0 Hz and positive speed limits in Hz.

Default Value: –	Parameter Type: Selection
Parameter Number: 2300	Unit: –
Data Type: UINT	Access Type: Read/Write



NOTE: Selection lists with inputs and/or outputs consist of the name of the hardware option and the numbers of the terminals. For example, terminal number 13 of the Basic I/O is called Basic I/O T13 in the selection list.

P 5.8.1.13 Absolute Speed Reference Output

Select an output terminal for the absolute speed reference, scaled between 0 and positive speed limit.

Default Value: –	Parameter Type: Selection
Parameter Number: 2304	Unit: –
Data Type: UINT	Access Type: Read/Write



NOTE: Selection lists with inputs and/or outputs consist of the name of the hardware option and the numbers of the terminals. For example, terminal number 13 of the Basic I/O is called Basic I/O T13 in the selection list.

P 5.8.1.14 Output Frequency Output

Select an output terminal for the output frequency scaled between minimum speed limit and positive speed limits in Hz.

Default Value:	–	Parameter Type:	Selection
Parameter Number:	2308	Unit:	–
Data Type:	UINT	Access Type:	Read/Write

 **NOTE:** Selection lists with inputs and/or outputs consist of the name of the hardware option and the numbers of the terminals. For example, terminal number 13 of the Basic I/O is called Basic I/O T13 in the selection list.

P 5.8.1.16 Load Drooping Speed

Shows the load drooping speed.

Default Value:	NA	Parameter Type:	Range (0 — 2000)
Parameter Number:	674	Unit:	Hz
Data Type:	REAL	Access Type:	Read Only

6.6.9.3 Speed Controller (Menu Index 5.8.2)

6.6.9.3.1 Basic Settings (Menu Index 5.8.2.1)

P 5.8.2.1.1 Speed Controller Type

Select the speed controller type.

Default Value:	1 (PI-Controller)	Parameter Type:	Selection
Parameter Number:	5005	Unit:	–
Data Type:	UINT	Access Type:	Read/Conditional Write

The following are the selections for the parameter.

Selection Number	Selection Name	Selection Description
0	P-Controller	Select P-controller (proportional control).
1	PI-Controller	Select PI-controller (proportional and integration control).

P 5.8.2.1.2 Speed Controller Kp FVC+

Set the proportional gain of the speed controller.

Default Value:	15	Parameter Type:	Range (0 — 1000)
Parameter Number:	4020	Unit:	PercentPerHertz
Data Type:	REAL	Access Type:	Read/Write

P 5.8.2.1.3 Speed Controller Ti FVC+

Set the integration time of the speed controller.

Default Value:	0.1	Parameter Type:	Range (0 — 100)
Parameter Number:	4021	Unit:	s
Data Type:	REAL	Access Type:	Read/Write

P 5.8.2.1.4 Acceleration Feedforward Gain

Set the acceleration feedforward gain. It bypasses the speed controller by adding torque reference based on requested acceleration and system inertia. Improves tracking of speed reference changes.

Default Value:	–	Parameter Type:	Range (0 — 10000)
Parameter Number:	4022	Unit:	%
Data Type:	REAL	Access Type:	Read/Write

P 5.8.2.1.5 Acceleration Feedforward Filter Tc

Set the acceleration feedforward filter time constant.

Default Value:	–	Parameter Type:	Range (0.00 — 1000000.00)
Parameter Number:	4039	Unit:	ms
Data Type:	REAL	Access Type:	Read/Write

P 5.8.2.1.7 Speed Controller Kp VVC+

Set the proportional gain of the speed controller.

Default Value:	0.015	Parameter Type:	Range (0 — 1)
Parameter Number:	4080	Unit:	–
Data Type:	REAL	Access Type:	Read/Write

P 5.8.2.1.8 Speed Controller Ti VVC+

Set the integration time of the speed controller.

Default Value:	0.008	Parameter Type:	Range (0.001 — 20)
Parameter Number:	4081	Unit:	s
Data Type:	REAL	Access Type:	Read/Write

6.6.9.3.2 Advanced Settings (Menu Index 5.8.2.2)

P 5.8.2.2.1 Virtual Friction Gain

Set the virtual friction gain, adding friction to the speed control loop to increase damping and stability. It is automatically adjusted when the system inertia is changed and parameter "5.8.11.1 Speed Controller Auto Tuning" is enabled.

Default Value:	–	Parameter Type:	Range (0 — 10000)
Parameter Number:	4549	Unit:	–
Data Type:	REAL	Access Type:	Read/Write

P 5.8.2.2.2 Low-speed Controller

Enables the low-speed controller. It should be enabled if fast torque reaction at low speed references is needed.

Default Value:	False	Parameter Type:	Selection
Parameter Number:	4070	Unit:	–
Data Type:	BOOL	Access Type:	Read/Write

The following are the selections for the parameter.

Selection Number	Selection Name	Selection Description
0	Disabled	Disables the function.
1	Enabled	Enables the function.

P 5.8.2.2.3 Low-speed Controller Gain

Set the proportional part of the low-speed controller. A higher value leads to higher dynamics.

Default Value:	50	Parameter Type:	Range (0 — 1000)
Parameter Number:	4071	Unit:	%
Data Type:	REAL	Access Type:	Read/Write

P 5.8.2.2.4 Kp Ratio at Low Speed

Set the gain ratio for the proportional part of the speed controller at frequencies below the value set in "5.8.2.2.5 Kp Adaptation Low Speed".

Default Value:	100	Parameter Type:	Range (1 — 1000)
Parameter Number:	4072	Unit:	%
Data Type:	REAL	Access Type:	Read/Write

P 5.8.2.2.5 Kp Adaptation Low Speed

Set the speed below which the speed controller proportional gain is fully using the value set in "5.8.2.2.4 Kp Ratio at Low Speed".

Default Value:	–	Parameter Type:	Range (0 — 10000)
Parameter Number:	4073	Unit:	Hz
Data Type:	REAL	Access Type:	Read/Write

P 5.8.2.2.6 Kp Adaptation High Speed

Set the speed above which the speed controller proportional gain is fully using the value set in "5.8.2.1.2 Speed Controller Kp FVC+".

Default Value:	–	Parameter Type:	Range (0 — 10000)
Parameter Number:	4074	Unit:	Hz
Data Type:	REAL	Access Type:	Read/Write

P 5.8.2.2.7 Kp Ratio at Low Torque

Set the gain ratio for the proportional part of the speed controller at a torque level below the lower torque limit.

Default Value:	100	Parameter Type:	Range (1 — 1000)
Parameter Number:	4075	Unit:	%
Data Type:	REAL	Access Type:	Read/Write

P 5.8.2.2.8 Kp Adaptation Low Torque

Set the torque level below which the speed controller proportional gain is fully using the value set in "5.8.2.2.7 Kp Ratio at Low Torque".

Default Value:	–	Parameter Type:	Range (0 — 1000)
Parameter Number:	4077	Unit:	%
Data Type:	REAL	Access Type:	Read/Write

P 5.8.2.2.9 Kp Adaptation High Torque

Set the torque level above which the speed controller proportional gain is fully using the value set in "5.8.2.1.2 Speed Controller Kp FVC +".

Default Value:	–	Parameter Type:	Range (0 — 1000)
Parameter Number:	4078	Unit:	%
Data Type:	REAL	Access Type:	Read/Write

P 5.8.2.2.10 Kp Adaptation Min at Low Flux

Set the gain ratio for the proportional part, if flux is reduced by field weakening or Automatic Energy Optimization (AEO).

Default Value:	40	Parameter Type:	Range (0 — 100)
Parameter Number:	4079	Unit:	%
Data Type:	REAL	Access Type:	Read/Write

P 5.8.2.2.11 Zero-speed Damping Gain

Set the zero-speed damping gain. It dampens speed fluctuations when the speed reference is 0.

Default Value:	100	Parameter Type:	Range (0 — 1000)
Parameter Number:	5434	Unit:	%
Data Type:	REAL	Access Type:	Read/Write

P 5.8.2.2.12 Additional Torque Feedforward

Enables additional torque feedforward using the torque reference chain. An extra torque can be added to the speed controller output by using the normal torque reference.

Default Value:	False	Parameter Type:	Selection
Parameter Number:	5020	Unit:	–
Data Type:	BOOL	Access Type:	Read/Write

The following are the selections for the parameter.

Selection Number	Selection Name	Selection Description
0	Disabled	Disables the function.
1	Enabled	Enables the function.

6.6.9.4 Speed Limits and Monitor (Menu Index 5.8.3)

P 5.8.3.1 Positive Speed Limit

Set the speed limit for positive direction.

Default Value:	50	Parameter Type:	Range (0 — *)
Parameter Number:	1729	Unit:	Hz
Data Type:	REAL	Access Type:	Read/Write

P 5.8.3.2 Negative Speed Limit

Set the speed limit for negative direction.

Default Value:	-50	Parameter Type:	Range (* — 0)
Parameter Number:	1728	Unit:	Hz
Data Type:	REAL	Access Type:	Read/Write

P 5.8.3.3 Minimum Speed Limit

Set the minimum speed for positive and negative direction.

Default Value:	–	Parameter Type:	Range (* — *)
Parameter Number:	1722	Unit:	Hz
Data Type:	REAL	Access Type:	Read/Write

P 5.8.3.4 High Speed Warning

Set the speed value which activates the high speed warning. Activated after 1 s.

Default Value:	1100	Parameter Type:	Range (0 — 1100)
Parameter Number:	1200	Unit:	Hz
Data Type:	REAL	Access Type:	Read/Write

P 5.8.3.5 High Speed Fault

Set the speed value which activates the high speed fault after a delay.

Default Value:	1100	Parameter Type:	Range (0 — 1100)
Parameter Number:	1201	Unit:	Hz
Data Type:	REAL	Access Type:	Read/Write

P 5.8.3.6 High Speed Fault Delay

Set the delay time after which a fault is issued if the speed set for high speed fault is exceeded.

Default Value:	10	Parameter Type:	Range (0 — 360)
Parameter Number:	1202	Unit:	s
Data Type:	UDINT	Access Type:	Read/Write

P 5.8.3.7 Start Speed Fault

Set the speed which must be reached within the delay time after start. Otherwise a fault is issued.

Default Value:	–	Parameter Type:	Range (0 — 1100)
Parameter Number:	1203	Unit:	Hz
Data Type:	REAL	Access Type:	Read/Write

P 5.8.3.8 Start Speed Fault Delay

Set the time after which a fault is the issued if start speed fault value is not reached.

Default Value:	20	Parameter Type:	Range (0 — 360)
Parameter Number:	1204	Unit:	s
Data Type:	UDINT	Access Type:	Read/Write

P 5.8.3.9 Low Speed Monitor Limit

Set the speed value which activates the low speed fault after a delay.

Default Value:	–	Parameter Type:	Range (0 — 10000)
Parameter Number:	1205	Unit:	Hz
Data Type:	REAL	Access Type:	Read/Write

P 5.8.3.10 Low Speed Fault Delay

Set the delay after which a fault is issued if speed drops below the level set for low speed monitor limit.

Default Value:	20	Parameter Type:	Range (0 — 360)
Parameter Number:	1206	Unit:	s
Data Type:	UDINT	Access Type:	Read/Write

6.6.9.5 Speed Reference (Menu Index 5.8.4)

P 5.8.4.1 Speed Reference 1 Input

Select the input terminal or a predefined fixed value for the speed reference.

Default Value:	–	Parameter Type:	Selection
Parameter Number:	501	Unit:	–
Data Type:	UINT	Access Type:	Read/Write

P 5.8.4.2 Speed Reference 2 Input

Select the input terminal or a predefined fixed value for the speed reference.

Default Value:	–	Parameter Type:	Selection
Parameter Number:	502	Unit:	–
Data Type:	UINT	Access Type:	Read/Write

P 5.8.4.3 Speed Reference 1 Max.

Set the maximum value of the reference. It defines the upper point for the scaling of the reference input.

Default Value:	100	Parameter Type:	Range (-1000 — 1000)
Parameter Number:	1724	Unit:	Hz
Data Type:	REAL	Access Type:	Read/Write

P 5.8.4.4 Speed Reference 1 Min.

Set the minimum value of the reference. It defines the lower point for the scaling of the reference input.

Default Value:	–	Parameter Type:	Range (-1000 — 1000)
Parameter Number:	1725	Unit:	Hz
Data Type:	REAL	Access Type:	Read/Write

P 5.8.4.5 Speed Reference 2 Max.

Set the maximum value of the reference. It defines the upper point for the scaling of the reference input.

Default Value:	100	Parameter Type:	Range (-1000 — 1000)
Parameter Number:	1726	Unit:	Hz

Data Type:	REAL	Access Type:	Read/Write
-------------------	------	---------------------	------------

P 5.8.4.6 Speed Reference 2 Min.

Set the minimum value of the reference. It defines the lower point for the scaling of the reference input.

Default Value:	–	Parameter Type:	Range (-1000 — 1000)
Parameter Number:	1727	Unit:	Hz
Data Type:	REAL	Access Type:	Read/Write

P 5.8.4.7 Preset Speed Reference Selector

Select the preset reference. The preset reference can be selected as a fixed value or by 3 digital inputs.

Default Value:	1 (Preset 1)	Parameter Type:	Selection
Parameter Number:	702	Unit:	–
Data Type:	UINT	Access Type:	Read/Write

The following are the selections for the parameter.

Selection Number	Selection Name	Selection Description
0	Bit Selection	Use digital inputs to select the preset reference number.
1	Preset 1	Use preset 1.
2	Preset 2	Use preset 2.
3	Preset 3	Use preset 3.
4	Preset 4	Use preset 4.
5	Preset 5	Use preset 5.
6	Preset 6	Use preset 6.
7	Preset 7	Use preset 7.
8	Preset 8	Use preset 8.

P 5.8.4.8 Preset Speed 1

Set the value of the preset reference.

Default Value:	10	Parameter Type:	Range (-1000 — 1000)
Parameter Number:	703	Unit:	Hz
Data Type:	REAL	Access Type:	Read/Write

P 5.8.4.9 Preset Speed 2

Set the value of the preset reference.

Default Value:	20	Parameter Type:	Range (-1000 — 1000)
Parameter Number:	704	Unit:	Hz
Data Type:	REAL	Access Type:	Read/Write

P 5.8.4.10 Preset Speed 3

Set the value of the preset reference.

Default Value:	30	Parameter Type:	Range (-1000 — 1000)
Parameter Number:	705	Unit:	Hz
Data Type:	REAL	Access Type:	Read/Write

P 5.8.4.11 Preset Speed 4

Set the value of the preset reference.

Default Value:	40	Parameter Type:	Range (-1000 — 1000)
Parameter Number:	706	Unit:	Hz
Data Type:	REAL	Access Type:	Read/Write

P 5.8.4.12 Preset Speed 5

Set the value of the preset reference.

Default Value:	50	Parameter Type:	Range (-1000 — 1000)
Parameter Number:	707	Unit:	Hz
Data Type:	REAL	Access Type:	Read/Write

P 5.8.4.13 Preset Speed 6

Set the value of the preset reference.

Default Value:	60	Parameter Type:	Range (-1000 — 1000)
Parameter Number:	708	Unit:	Hz
Data Type:	REAL	Access Type:	Read/Write

P 5.8.4.14 Preset Speed 7

Set the value of the preset reference.

Default Value:	70	Parameter Type:	Range (-1000 — 1000)
Parameter Number:	709	Unit:	Hz
Data Type:	REAL	Access Type:	Read/Write

P 5.8.4.15 Preset Speed 8

Set the value of the preset reference.

Default Value:	80	Parameter Type:	Range (-1000 — 1000)
Parameter Number:	710	Unit:	Hz
Data Type:	REAL	Access Type:	Read/Write

P 5.8.4.16 Preset Speed Reference Bit 0 Input

Select the digital input used as bit 0 addressing the preset reference.

Default Value:	–	Parameter Type:	Selection
Parameter Number:	711	Unit:	–
Data Type:	UINT	Access Type:	Read/Write

P 5.8.4.17 Preset Speed Reference Bit 1 Input

Select the digital input used as bit 1 for addressing the preset reference.

Default Value:	–	Parameter Type:	Selection
Parameter Number:	712	Unit:	–
Data Type:	UINT	Access Type:	Read/Write

P 5.8.4.18 Preset Speed Reference Bit 2 Input

Select the digital input used as bit 2 for addressing the preset reference.

Default Value:	–	Parameter Type:	Selection
Parameter Number:	713	Unit:	–
Data Type:	UINT	Access Type:	Read/Write

P 5.8.4.19 Fieldbus Speed Reference Scale

Set the fieldbus reference scale equal to 100% reference.

Default Value:	50	Parameter Type:	Range (0 — 1000)
Parameter Number:	1723	Unit:	Hz
Data Type:	REAL	Access Type:	Read/Write

P 5.8.4.21 Speed Ref. Filter Tc

Set the time constant of the reference filter. Set to 0 disables the filter.

Default Value:	–	Parameter Type:	Range (0 — 1000)
Parameter Number:	1719	Unit:	s
Data Type:	REAL	Access Type:	Read/Write

6.6.9.6 Reference Freeze (Menu Index 5.8.5)

This feature makes it possible to freeze the active reference by a digital input to the actual output speed and to increase/decrease the reference by using 2 other digital inputs. Additionally, independent ramp times, delays, and speed steps can be configured.

When enabling the freeze reference feature, the reference is frozen to the actual output. If this reference is out of the allowed speed range, the frozen reference is set to the closest speed limit. After starting up or after cycling the power of the drive, the reference for the freeze feature is set to either the last freeze reference or to the minimum speed of the drive. See parameter **5.8.5.7 Freeze Initialization**.

When reaching the upper speed limit or the lower speed limit of the drive, the freeze reference is not further increased or decreased in the limited direction. If the drive is configured for both rotation directions and a minimum speed has been defined, the reference bypasses the area between the positive and the negative minimum speed while Freeze Up or Freeze Down are used.

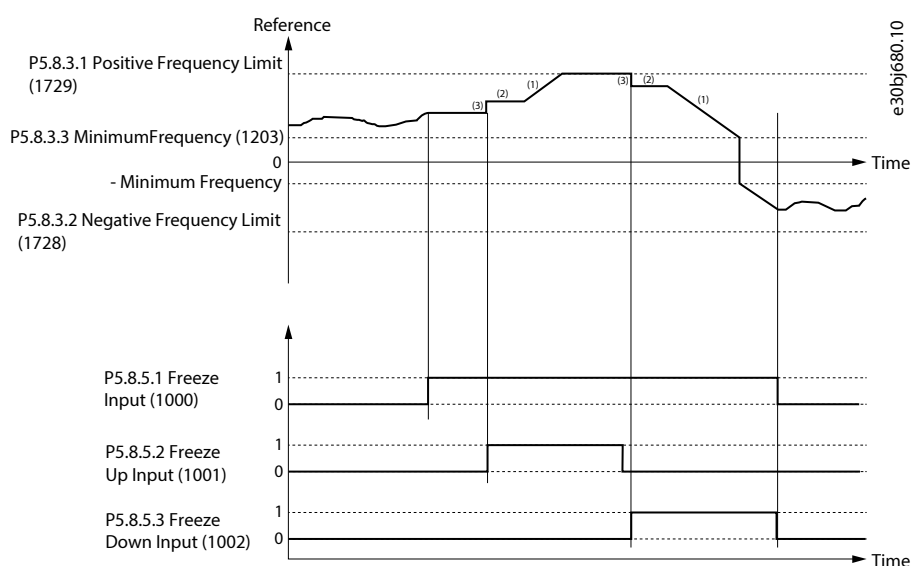

Figure 71: Reference Freeze Example

- | | | | |
|---|---------------------------|---|---------------------------|
| 1 | Freeze Up/Down Ramp Time | 2 | Freeze Up/Down Ramp Delay |
| 3 | Freeze Up/Down Step Delta | | |

P 5.8.5.1 Freeze Input

Select the digital input for freezing the reference. Freezing is used to control the speed reference with 2 digital inputs, 1 increasing the reference and the other decreasing the reference.

Default Value:	–	Parameter Type:	Selection
Parameter Number:	1000	Unit:	–
Data Type:	UINT	Access Type:	Read/Write

P 5.8.5.2 Freeze Up Input

Select the digital input for increasing the reference while reference freezing is activated.

Default Value:	–	Parameter Type:	Selection
Parameter Number:	1001	Unit:	–
Data Type:	UINT	Access Type:	Read/Write

P 5.8.5.3 Freeze Down Input

Select the digital input for decreasing the reference while reference freezing is activated.

Default Value:	–	Parameter Type:	Selection
Parameter Number:	1002	Unit:	–
Data Type:	UINT	Access Type:	Read/Write

P 5.8.5.4 Freeze Ramp Time

Set the ramp time for increasing/decreasing the reference while reference freeze is active.

Default Value:	10	Parameter Type:	Range (0 — 1000)
Parameter Number:	1003	Unit:	s

Data Type:	REAL	Access Type:	Read/Write
-------------------	------	---------------------	------------

P 5.8.5.5 Freeze Ramp Delay

Set the delay before ramping the reference while reference freeze is active.

Default Value:	4	Parameter Type:	Range (0 — 3600)
Parameter Number:	1004	Unit:	s
Data Type:	UDINT	Access Type:	Read/Write

P 5.8.5.6 Freeze Step Delta

Set the reference step for increasing/decreasing the reference while reference freeze is active.

Default Value:	1	Parameter Type:	Range (0 — 1000)
Parameter Number:	1005	Unit:	Hz
Data Type:	REAL	Access Type:	Read/Write

P 5.8.5.7 Freeze Initialization

Enables freeze initialization. If enabled, freeze reference is initialized to the minimum speed after start-up or a start signal is applied. If disabled, the latest value is used.

Default Value:	False	Parameter Type:	Selection
Parameter Number:	1006	Unit:	–
Data Type:	BOOL	Access Type:	Read/Write

The following are the selections for the parameter.

Selection Number	Selection Name	Selection Description
0	Disabled	Disables the function.
1	Enabled	Enables the function.

P 5.8.5.8 Freeze Ramp/Step Mode

Select how to increase or decrease the reference while reference freeze is active.

Default Value:	0 (Step and Ramp)	Parameter Type:	Selection
Parameter Number:	1007	Unit:	–
Data Type:	UINT	Access Type:	Read/Write

The following are the selections for the parameter.

Selection Number	Selection Name	Selection Description
0	Step and Ramp	Step increment and ramp thereafter.
1	Ramp	Ramp increment.
2	Step	Step increment.

6.6.9.7 Speed Ramps (Menu Index 5.8.6)

6.6.9.7.1 Speed Ramps Overview

Ramps are used for reaching the desired speed reference in a controlled manner. The parameters in the Speed Ramps parameter group is used to select the ramp type and to adjust their shapes.

Ramps 1–4 can be configured as linear or S-ramps. A linear ramp provides the motor a constant acceleration. The S-ramp allows the drive to compensate for jerk in the application and/or to reduce sway.

Anti-sway is a ramp type selection for cranes with a hanging load.

The following diagram illustrates how the ramp parameters are used for adjusting the ramp profiles.

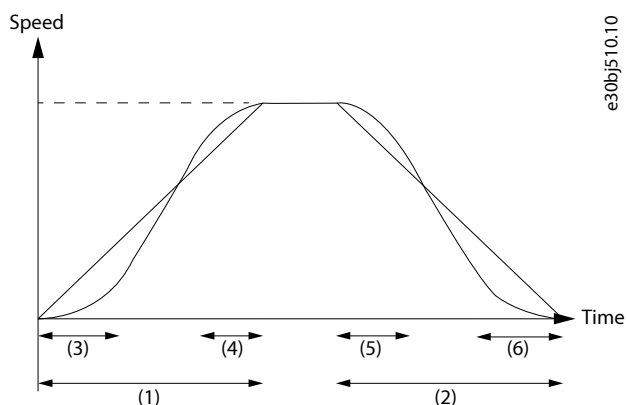

Figure 72: Speed Ramps

1	Ramp acceleration time	2	Ramp deceleration time
3	Ramp acceleration increase time for S-ramps	4	Ramp acceleration decrease time for S-ramps
5	Ramp deceleration increase time for S-ramps	6	Ramp deceleration decrease time for S-ramps

Furthermore, the drive supports a variable ramp profile, which allows the changing of the acceleration and deceleration time dynamically with analog inputs.

Anti-sway

The anti-sway ramp enables smooth starting and stopping without causing the load to swing excessively. Anti-sway is only meant to be used on the drive that moves the load horizontally.

Anti-sway can only be used with a linear ramp. If anti-sway is enabled when an S-ramp is selected, a linear ramp is applied instead of the S-ramp.

When anti-sway is enabled, the ramp time calculated in the anti-sway module is used during acceleration and deceleration from the actual speed to the set speed reference.

Anti-sway is enabled with parameter **5.8.6.1.7 Enable Anti-Sway**, and configured with the parameters in parameter group **5.8.6.8 Anti-Sway**.

6.6.9.7.2 Speed Ramp Settings (Menu Index 5.8.6.1)

P 5.8.6.1.1 Ramp Selector

Select the speed ramp.

Default Value:	0 (Ramp 1)	Parameter Type:	Selection
Parameter Number:	1100	Unit:	–

Data Type:	UINT	Access Type:	Read/Write
-------------------	------	---------------------	------------

The following are the selections for the parameter.

Selection Number	Selection Name	Selection Description
4	Bit Selection	Use digital inputs to select ramp.
0	Ramp 1	Use ramp 1.
1	Ramp 2	Use ramp 2.
2	Ramp 3	Use ramp 3.
3	Ramp 4	Use ramp 4.
5	Variable Ramp.	

P 5.8.6.1.2 Ramp Selection Bit 0 Input

Select the digital input used as bit 0 addressing the speed ramp.

Default Value:	–	Parameter Type:	Selection
Parameter Number:	1130	Unit:	–
Data Type:	UINT	Access Type:	Read/Write

P 5.8.6.1.3 Ramp Selection Bit 1 Input

Select the digital input used as bit 1 addressing the speed ramp.

Default Value:	–	Parameter Type:	Selection
Parameter Number:	1131	Unit:	–
Data Type:	UINT	Access Type:	Read/Write

P 5.8.6.1.7 Enable Anti-Sway

Enables the anti-sway functionality.

Default Value:	0	Parameter Type:	Range (False — True)
Parameter Number:	1144	Unit:	–
Data Type:	BOOL	Access Type:	Read/Write

6.6.9.7.3 Ramp 1 (Menu Index 5.8.6.2)

P 5.8.6.2.1 Ramp 1 Type

Select the ramp type.

Default Value:	0 (Linear Ramp)	Parameter Type:	Selection
Parameter Number:	1125	Unit:	–
Data Type:	UINT	Access Type:	Read/Write

The following are the selections for the parameter.

Selection Number	Selection Name	Selection Description
0	Linear Ramp	Use linear ramp.
1	S-Ramp	Use S-ramp ramp reducing torque changes.

P 5.8.6.2.2 Ramp 1 Accel. Time

Set the acceleration time from 0 to nominal motor speed.

Default Value:	5	Parameter Type:	Range (0 — 10000)
Parameter Number:	1101	Unit:	s
Data Type:	REAL	Access Type:	Read/Write

P 5.8.6.2.3 Ramp 1 Decel. Time

Set the deceleration time from nominal motor speed to 0.

Default Value:	5	Parameter Type:	Range (0 — 10000)
Parameter Number:	1105	Unit:	s
Data Type:	REAL	Access Type:	Read/Write

P 5.8.6.2.4 S-Ramp 1 Accel. Increase Time

Set the ramp acceleration increase time for S-ramp.

Default Value:	1	Parameter Type:	Range (0 — 10000)
Parameter Number:	1109	Unit:	s
Data Type:	REAL	Access Type:	Read/Write

P 5.8.6.2.5 S-Ramp 1 Accel. Decrease Time

Set the ramp acceleration decrease time for S-ramp.

Default Value:	1	Parameter Type:	Range (0 — 10000)
Parameter Number:	1113	Unit:	s
Data Type:	REAL	Access Type:	Read/Write

P 5.8.6.2.6 S-Ramp 1 Decel. Increase Time

Set the ramp deceleration increase time for S-ramp.

Default Value:	1	Parameter Type:	Range (0 — 10000)
Parameter Number:	1117	Unit:	s
Data Type:	REAL	Access Type:	Read/Write

P 5.8.6.2.7 S-Ramp 1 Decel. Decrease Time

Set the ramp deceleration decrease time for S-ramp.

Default Value:	1	Parameter Type:	Range (0 — 10000)
Parameter Number:	1121	Unit:	s
Data Type:	REAL	Access Type:	Read/Write

6.6.9.7.4 Ramp 2 (Menu Index 5.8.6.3)

P 5.8.6.3.1 Ramp 2 Type

Select the ramp type.

Default Value:	0 (Linear Ramp)	Parameter Type:	Selection
Parameter Number:	1126	Unit:	–
Data Type:	UINT	Access Type:	Read/Write

The following are the selections for the parameter.

Selection Number	Selection Name	Selection Description
0	Linear Ramp	Use linear ramp.
1	S-Ramp	Use S-ramp ramp reducing torque changes.

P 5.8.6.3.2 Ramp 2 Accel. Time

Set the acceleration time from 0 to nominal motor speed.

Default Value:	5	Parameter Type:	Range (0 — 10000)
Parameter Number:	1106	Unit:	s
Data Type:	REAL	Access Type:	Read/Write

P 5.8.6.3.3 Ramp 2 Decel. Time

Set the deceleration time from nominal motor speed to 0.

Default Value:	5	Parameter Type:	Range (0 — 10000)
Parameter Number:	1102	Unit:	s
Data Type:	REAL	Access Type:	Read/Write

P 5.8.6.3.4 S-Ramp 2 Accel. Increase Time

Set the ramp acceleration increase time for S-ramp.

Default Value:	1	Parameter Type:	Range (0 — 10000)
Parameter Number:	1110	Unit:	s
Data Type:	REAL	Access Type:	Read/Write

P 5.8.6.3.5 S-Ramp 2 Accel. Decrease Time

Set the ramp acceleration decrease time for S-ramp.

Default Value:	1	Parameter Type:	Range (0 — 10000)
Parameter Number:	1114	Unit:	s
Data Type:	REAL	Access Type:	Read/Write

P 5.8.6.3.6 S-Ramp 2 Decel. Increase Time

Set the ramp deceleration increase time for S-ramp.

Default Value:	1	Parameter Type:	Range (0 — 10000)
-----------------------	---	------------------------	-------------------

Parameter Number: 1118	Unit: s
Data Type: REAL	Access Type: Read/Write

P 5.8.6.3.7 S-Ramp 2 Decel. Decrease Time

Set the ramp deceleration decrease time for S-ramp.

Default Value: 1	Parameter Type: Range (0 — 10000)
Parameter Number: 1122	Unit: s
Data Type: REAL	Access Type: Read/Write

6.6.9.7.5 Ramp 3 (Menu Index 5.8.6.4)

P 5.8.6.4.1 Ramp 3 Type

Select the ramp type.

Default Value: 0 (Linear Ramp)	Parameter Type: Selection
Parameter Number: 1127	Unit: –
Data Type: UINT	Access Type: Read/Write

The following are the selections for the parameter.

Selection Number	Selection Name	Selection Description
0	Linear Ramp	Use linear ramp.
1	S-Ramp	Use S-ramp ramp reducing torque changes.

P 5.8.6.4.2 Ramp 3 Accel. Time

Set the acceleration time from 0 to nominal motor speed.

Default Value: 5	Parameter Type: Range (0 — 10000)
Parameter Number: 1103	Unit: s
Data Type: REAL	Access Type: Read/Write

P 5.8.6.4.3 Ramp 3 Decel. Time

Set the deceleration time from nominal motor speed to 0.

Default Value: 5	Parameter Type: Range (0 — 10000)
Parameter Number: 1107	Unit: s
Data Type: REAL	Access Type: Read/Write

P 5.8.6.4.4 S-Ramp 3 Accel. Increase Time

Set the ramp acceleration increase time for S-ramp.

Default Value: 1	Parameter Type: Range (0 — 10000)
Parameter Number: 1111	Unit: s
Data Type: REAL	Access Type: Read/Write

P 5.8.6.4.5 S-Ramp 3 Accel. Decrease Time

Set the ramp acceleration decrease time for S-ramp.

Default Value:	1	Parameter Type:	Range (0 — 10000)
Parameter Number:	1115	Unit:	s
Data Type:	REAL	Access Type:	Read/Write

P 5.8.6.4.6 S-Ramp 3 Decel. Increase Time

Set the ramp deceleration increase time for S-ramp.

Default Value:	1	Parameter Type:	Range (0 — 10000)
Parameter Number:	1119	Unit:	s
Data Type:	REAL	Access Type:	Read/Write

P 5.8.6.4.7 S-Ramp 3 Decel. Decrease Time

Set the ramp deceleration decrease time for S-ramp.

Default Value:	1	Parameter Type:	Range (0 — 10000)
Parameter Number:	1123	Unit:	s
Data Type:	REAL	Access Type:	Read/Write

6.6.9.7.6 **Ramp 4 (Menu Index 5.8.6.5)**

P 5.8.6.5.1 Ramp 4 Type

Select the ramp type.

Default Value:	0 (Linear Ramp)	Parameter Type:	Selection
Parameter Number:	1128	Unit:	–
Data Type:	UINT	Access Type:	Read/Write

The following are the selections for the parameter.

Selection Number	Selection Name	Selection Description
0	Linear Ramp	Use linear ramp.
1	S-Ramp	Use S-ramp ramp reducing torque changes.

P 5.8.6.5.2 Ramp 4 Accel. Time

Set the acceleration time from 0 to nominal motor speed.

Default Value:	5	Parameter Type:	Range (0 — 10000)
Parameter Number:	1104	Unit:	s
Data Type:	REAL	Access Type:	Read/Write

P 5.8.6.5.3 Ramp 4 Decel. Time

Set the deceleration time from nominal motor speed to 0.

Default Value:	5	Parameter Type:	Range (0 — 10000)
Parameter Number:	1108	Unit:	s

Data Type:	REAL	Access Type:	Read/Write
-------------------	------	---------------------	------------

P 5.8.6.5.4 S-Ramp 4 Accel. Increase Time

Set the ramp acceleration increase time for S-ramp.

Default Value:	1	Parameter Type:	Range (0 — 10000)
Parameter Number:	1112	Unit:	s
Data Type:	REAL	Access Type:	Read/Write

P 5.8.6.5.5 S-Ramp 4 Accel. Decrease Time

Set the ramp acceleration decrease time for S-ramp.

Default Value:	1	Parameter Type:	Range (0 — 10000)
Parameter Number:	1116	Unit:	s
Data Type:	REAL	Access Type:	Read/Write

P 5.8.6.5.6 S-Ramp 4 Decel. Increase Time

Set the ramp deceleration increase time for S-ramp.

Default Value:	1	Parameter Type:	Range (0 — 10000)
Parameter Number:	1120	Unit:	s
Data Type:	REAL	Access Type:	Read/Write

P 5.8.6.5.7 S-Ramp 4 Decel. Decrease Time

Set the ramp deceleration decrease time for S-ramp.

Default Value:	1	Parameter Type:	Range (0 — 10000)
Parameter Number:	1124	Unit:	s
Data Type:	REAL	Access Type:	Read/Write

6.6.9.7.7 Variable Ramp (Menu Index 5.8.6.6)

P 5.8.6.6.1 Accel. Time Input

Select the input or a fixed value for adjusting the variable ramp acceleration time.

Default Value:	–	Parameter Type:	Selection
Parameter Number:	1132	Unit:	–
Data Type:	UINT	Access Type:	Read/Write

P 5.8.6.6.2 Accel. Time Maximum

Set the maximum of the acceleration time for the variable ramp.

Default Value:	120	Parameter Type:	Range (0 — 10000)
Parameter Number:	1134	Unit:	s
Data Type:	REAL	Access Type:	Read/Write

P 5.8.6.6.3 Accel. Time Minimum

Set the minimum of the acceleration time for the variable ramp.

Default Value:	–	Parameter Type:	Range (0 — 10000)
Parameter Number:	1135	Unit:	s
Data Type:	REAL	Access Type:	Read/Write

P 5.8.6.6.4 Decel. Time Input

Select the input or a fixed value for adjusting the variable ramp deceleration time.

Default Value:	–	Parameter Type:	Selection
Parameter Number:	1133	Unit:	–
Data Type:	UINT	Access Type:	Read/Write

P 5.8.6.6.5 Decel. Time Maximum

Set the maximum of the deceleration time for the variable ramp.

Default Value:	120	Parameter Type:	Range (0 — 10000)
Parameter Number:	1136	Unit:	s
Data Type:	REAL	Access Type:	Read/Write

P 5.8.6.6.6 Decel. Time Minimum

Set the minimum of the deceleration time for the variable ramp.

Default Value:	–	Parameter Type:	Range (0 — 10000)
Parameter Number:	1137	Unit:	s
Data Type:	REAL	Access Type:	Read/Write

6.6.9.7.8 Anti Sway (Menu Index 5.8.6.8)

The anti-sway feature generates a ramping profile that dampens the sway that occurs when a crane moves a load horizontally, and the load is hanging on a rope.

The ramping profile is calculated from the pendulum created by the load. The pendulum can be calculated by the rope length.

Set either parameter **5.8.6.8.1 Rope Length** or **5.8.6.8.2 Swing Period** as input for the calculation of the ramp profile.

The parameter **5.8.6.8.3 Reference Change Limit** defines the size of the reference step that results in this special ramp profile. Reference steps below this value will be handled by a normal ramp.

The actual ramp time is determined by *Rope Length / Swing Period* and is shown in the readout parameter **5.8.6.8.4 Actual Ramp Time**.

P 5.8.6.8.1 Rope Length

Length of the cable used in the calculation of ramps in the anti-sway functionality.

Default Value:	1.49	Parameter Type:	Range (0.50 — 24.91)
Parameter Number:	1140	Unit:	LengthInMeters
Data Type:	REAL	Access Type:	Read/Write

P 5.8.6.8.2 Swing Period

Swing period used in the calculation of ramps in the anti-sway functionality.

Default Value:	3	Parameter Type:	Range (1 — 50)
-----------------------	---	------------------------	----------------

Parameter Number:	1141	Unit:	s
Data Type:	REAL	Access Type:	Read/Write

P 5.8.6.8.3 Reference Change Limit

Limit of speed reference change for using the ramps calculated in the anti-sway functionality.

Default Value:	2	Parameter Type:	Range (1 — 50)
Parameter Number:	1142	Unit:	Hz
Data Type:	REAL	Access Type:	Read/Write

P 5.8.6.8.4 Actual Ramp Time

Actual ramp time calculated in the anti-sway functionality.

Default Value:	NA	Parameter Type:	Range (* — *)
Parameter Number:	1143	Unit:	s
Data Type:	REAL	Access Type:	Read Only

6.6.9.8 Speed Feedback (Menu Index 5.8.7)

P 5.8.7.1 Speed Feedback Filter Tc

Set the speed feedback filter time constant (when the speed is controlled with speed sensor).

Default Value:	5.00	Parameter Type:	Range (0.00 — 1000.00)
Parameter Number:	4544	Unit:	ms
Data Type:	REAL	Access Type:	Read/Write

P 5.8.7.2 Estimated Speed Filter Tc

Set the filter time constant for the estimated speed (when the speed is controlled without speed sensor).

Default Value:	10.00	Parameter Type:	Range (5.00 — 100000.00)
Parameter Number:	4545	Unit:	ms
Data Type:	REAL	Access Type:	Read/Write

P 5.8.7.3 Feedback Angle Offset

Set the offset between permanent magnet (direct axis) angle and absolute feedback angle in the electrical domain. The offset value is summed with the feedback angle to attain the permanent magnet angle used in the control. Its correct setting is important when running FVC+ with synchronous motors in closed loop.

Default Value:	–	Parameter Type:	Range (0 — 360)
Parameter Number:	9017	Unit:	°
Data Type:	REAL	Access Type:	Read/Write

6.6.9.9 Speed Bypass (Menu Index 5.8.8)

Some systems call for some output frequencies to be avoided due to, for example, mechanical resonance problems. With the parameters of this group, a definition of the bandwidth around each of these parameters can be provided.

These parameters allow the setting of up to 4 speed bands that are avoided.

P 5.8.8.1 Band 1, Low Limit

Set the bypass hysteresis speed band, low limit.

Default Value:	–	Parameter Type:	Range (0 — 100)
Parameter Number:	4520	Unit:	Hz
Data Type:	REAL	Access Type:	Read/Write

P 5.8.8.2 Band 1, High Limit

Set the bypass hysteresis speed band, high limit.

Default Value:	–	Parameter Type:	Range (0 — 100)
Parameter Number:	4521	Unit:	Hz
Data Type:	REAL	Access Type:	Read/Write

P 5.8.8.3 Band 2, Low Limit

Set the bypass hysteresis speed band, low limit.

Default Value:	–	Parameter Type:	Range (0 — 100)
Parameter Number:	4522	Unit:	Hz
Data Type:	REAL	Access Type:	Read/Write

P 5.8.8.4 Band 2, High Limit

Set the bypass hysteresis speed band, high limit.

Default Value:	–	Parameter Type:	Range (0 — 100)
Parameter Number:	4523	Unit:	Hz
Data Type:	REAL	Access Type:	Read/Write

P 5.8.8.5 Band 3, Low Limit

Set the bypass hysteresis speed band, low limit.

Default Value:	–	Parameter Type:	Range (0 — 100)
Parameter Number:	4524	Unit:	Hz
Data Type:	REAL	Access Type:	Read/Write

P 5.8.8.6 Band 3, High Limit

Set the bypass hysteresis speed band, high limit.

Default Value:	–	Parameter Type:	Range (0 — 100)
Parameter Number:	4525	Unit:	Hz
Data Type:	REAL	Access Type:	Read/Write

P 5.8.8.7 Band 4, Low Limit

Set the bypass hysteresis speed band, low limit.

Default Value:	–	Parameter Type:	Range (0 — 100)
Parameter Number:	4526	Unit:	Hz
Data Type:	REAL	Access Type:	Read/Write

P 5.8.8.8 Band 4, High Limit

Set the bypass hysteresis speed band, high limit.

Default Value:	–	Parameter Type:	Range (0 — 100)
Parameter Number:	4527	Unit:	Hz
Data Type:	REAL	Access Type:	Read/Write

6.6.9.10 Load Drooping (Menu Index 5.8.9)

P 5.8.9.1 Load Drooping Mode

Select the load drooping mode - Only available in FVC+ mode.

Default Value:	0 (Static)	Parameter Type:	Selection
Parameter Number:	670	Unit:	–
Data Type:	UINT	Access Type:	Read/Write

The following are the selections for the parameter.

Selection Number	Selection Name	Selection Description
0	Static	Simple and robust drooping, but will result in a speed error on depending load.
1	Dynamic	This will run at correct speed independent of load, but requires synchronized start stop to avoid torque deviation between drives.
2	Combined	This will run a mix of static and dynamic drooping at low speed, otherwise identical with dynamic.

P 5.8.9.2 Load Drooping %

Set the load drooping amount in % of nominal motor speed at nominal load conditions.

Default Value:	–	Parameter Type:	Range (0 — 1000)
Parameter Number:	671	Unit:	%
Data Type:	REAL	Access Type:	Read/Write

P 5.8.9.3 Load Drooping LP Tc

Set the load drooping low pass filter time constant.

Default Value:	5.00	Parameter Type:	Range (0.00 — 1000.00)
Parameter Number:	672	Unit:	ms
Data Type:	REAL	Access Type:	Read/Write

P 5.8.9.4 Load Drooping HP Tc

Set the load drooping high pass filter time constant. Only active in dynamic drooping mode.

Default Value:	1000.00	Parameter Type:	Range (0.00 — 100000.00)
Parameter Number:	673	Unit:	ms
Data Type:	REAL	Access Type:	Read/Write

P 5.8.9.5 Drooping Removal Mode

Select the drooping removal mode.

Default Value:	0 (Constant droop)	Parameter Type:	Selection
Parameter Number:	4581	Unit:	–
Data Type:	UINT	Access Type:	Read/Write

The following are the selections for the parameter.

Selection Number	Selection Name	Selection Description
0	Constant droop	If Constant Droop is selected drooping removal functionality is disabled. Speed could be even reduced to opposite speed direction.
1	Below removal frequency	Drooping gain is reduced from removal frequency to zero. This mode protects from running opposite speed direction.
2	Linear below nom. speed	Drooping gain is reduced linear from nominal motor frequency to zero.

P 5.8.9.6 Drooping Removal Transition Speed

Set the drooping removal transition speed.

Default Value:	1	Parameter Type:	Range (0.001 — 1000)
Parameter Number:	4582	Unit:	Hz
Data Type:	REAL	Access Type:	Read/Write

P 5.8.9.15 Enhanced Static Part

Set the % of static drooping at speeds lower than the value set in "5.8.9.16 Enhanced Lower Transition Speed". 0% means dynamic drooping only and 100% static drooping only.

Default Value:	1.5	Parameter Type:	Range (0 — 100)
Parameter Number:	675	Unit:	%
Data Type:	REAL	Access Type:	Read/Write

P 5.8.9.16 Enhanced Lower Transition Speed

Set the speed at which transition from combined static and dynamic drooping to dynamic drooping only starts.

Default Value:	589.999	Parameter Type:	Range (0 — *)
Parameter Number:	676	Unit:	Hz
Data Type:	REAL	Access Type:	Read/Write

P 5.8.9.17 Enhanced Higher Transition Speed

Set the speed at which the transition from combined static and dynamic drooping to dynamic drooping only is complete.

Default Value:	590	Parameter Type:	Range (* — *)
Parameter Number:	677	Unit:	Hz
Data Type:	REAL	Access Type:	Read/Write

6.6.9.11 Auto Tuning (Menu Index 5.8.11)

P 5.8.11.1 Speed Controller Auto Tuning

Enables the auto tuning of the speed controller. Auto tuning is started when the value of the parameter "5.3.2.4 System Inertia" is changed and unequal to "0".

Default Value:	False	Parameter Type:	Range (False — True)
Parameter Number:	4546	Unit:	–
Data Type:	BOOL	Access Type:	Read/Conditional Write

P 5.8.11.2 Auto Tuning Bandwidth

Set the auto tuning bandwidth. A higher value leads to a faster response to speed or reference changes.

Default Value:	100	Parameter Type:	Range (0 — 1000)
Parameter Number:	4547	Unit:	%
Data Type:	REAL	Access Type:	Read/Write

P 5.8.11.3 System Friction

Set the total system friction in % of the nominal motor torque at nominal motor speed.

Default Value:	–	Parameter Type:	Range (0 — 100)
Parameter Number:	4548	Unit:	%
Data Type:	REAL	Access Type:	Read/Write

6.6.10 Torque control (Menu Index 5.9)

6.6.10.1 Torque Control Overview

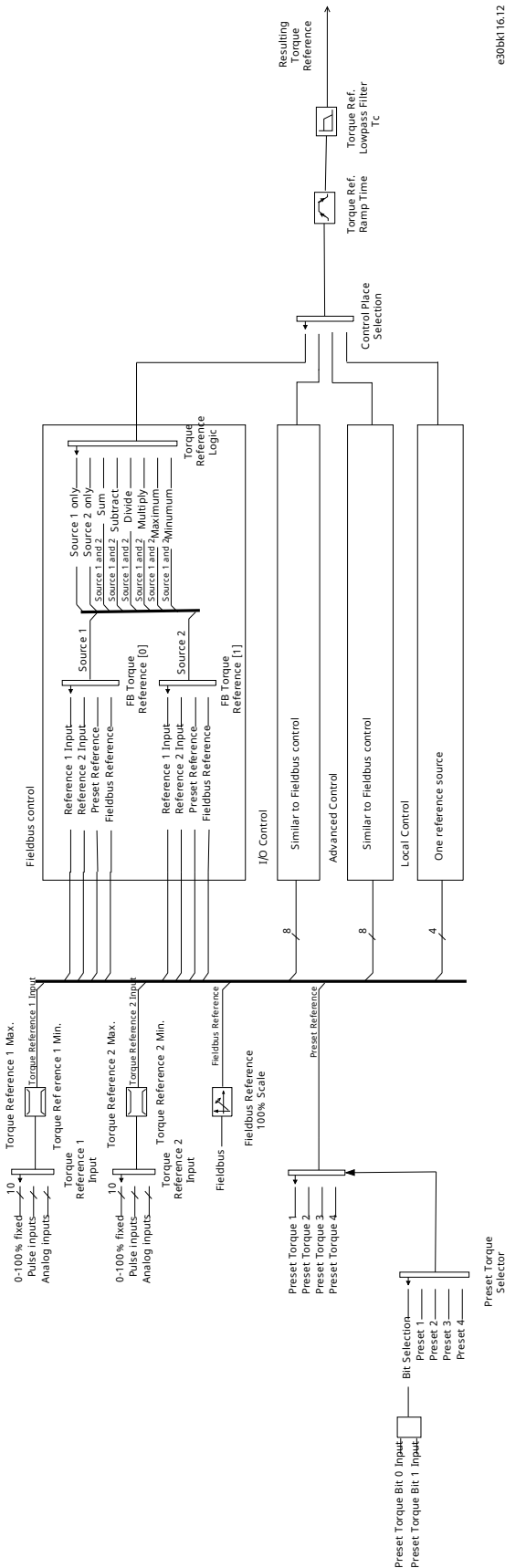

Figure 73: Reference Handling for Torque Control

While the drive is in torque control, motor speed is not controlled. Motor speed can reach speed limits, when the load application or upper system such as PLC system does not operate within the speed limits. If a speed limit is reached, the drive prevents itself from exceeding the limit depending on the selection in the parameter *Speed Limit Mode Torque Ctrl.* Detailed descriptions of the selections available in parameter *Speed Limit Mode Torque Ctrl.*

Pos./neg. frequency limit

By default, the selection for the parameter *Speed Limit Mode Torque Ctrl.* is *Pos./Neg. Frequency Limit.* While the drive is in torque control, the speed is not limited by the speed reference, only by the positive frequency limit and by the negative frequency limit.

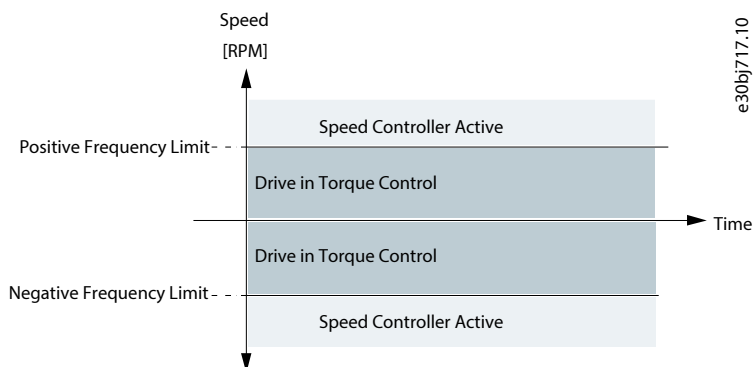

Figure 74: Pos./Neg. Frequency Limit

Limited by ramp

While the drive is in torque control, the speed is limited by the reference (after ramp). The speed increases with the set ramp time until actual torque is equal to the torque reference. If the speed is below the reference when load is removed from the shaft the speed increases without ramp.

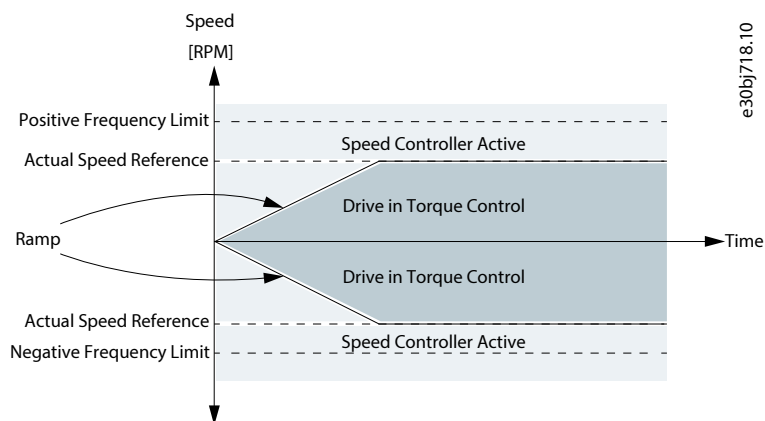

Figure 75: Limited by Ramp

Neg. limit to ramp

The torque controller operates in the range between the frequency limit for the negative direction and the speed limit given by the ramp.

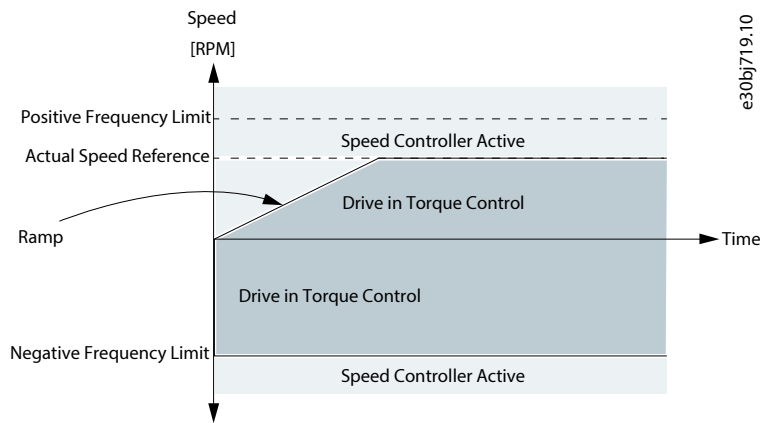

Figure 76: Neg. Limit to Ramp

Ramp to max. limit

The maximum of the speed controller output and the torque reference is selected as final torque reference. The torque controller operates in the range between the frequency limit for the positive direction and the speed limit given by the ramp.

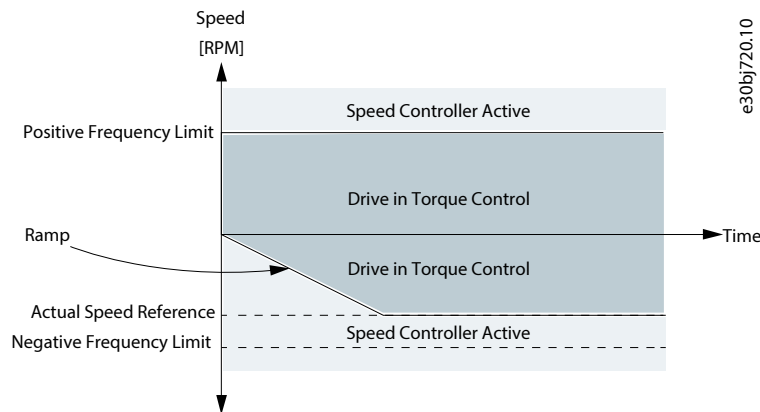

Figure 77: Ramp to Max. Limit

Window

Torque control is active within a speed window around the speed reference. Speed control activation limit is different from the speed limit. Therefore speed is required to reach first to upper or lower window limit before the speed controller activates.

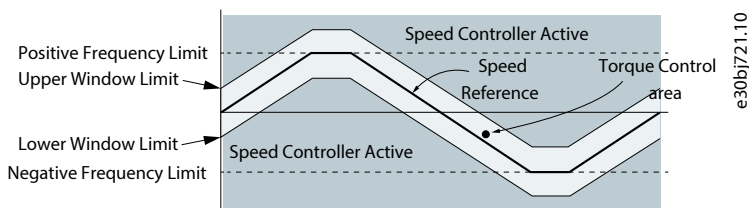

Figure 78: Window

6.6.10.2 Torque Control Status (Menu Index 5.9.1)

P 5.9.1.1 Motor Torque

Shows the actual motor torque.

Default Value:	NA	Parameter Type:	Range (-10000000 — 10000000)
Parameter Number:	9009	Unit:	Nm
Data Type:	REAL	Access Type:	Read Only

P 5.9.1.2 Relative Motor Torque

Shows the motor torque in % of the nominal motor torque.

Default Value:	NA	Parameter Type:	Range (* — *)
Parameter Number:	1708	Unit:	%
Data Type:	REAL	Access Type:	Read Only

P 5.9.1.3 Torque Limit Motoring

Shows the torque limit in motoring mode in % of nominal motor torque.

Default Value:	NA	Parameter Type:	Range (0 — 500)
Parameter Number:	1812	Unit:	%
Data Type:	REAL	Access Type:	Read/Write

P 5.9.1.4 Torque Limit Regenerative

Shows the regenerative torque limit in % of nominal motor torque.

Default Value:	NA	Parameter Type:	Range (0 — 500)
Parameter Number:	1813	Unit:	%
Data Type:	REAL	Access Type:	Read/Write

P 5.9.1.5 Local Torque Reference

Shows the local torque reference set in the control panel.

Default Value:	NA	Parameter Type:	Range (-300 — 300)
Parameter Number:	6155	Unit:	%
Data Type:	REAL	Access Type:	Read/Write

P 5.9.1.6 Torque Reference

Shows the value of the current torque reference in the reference chain in % of nominal motor torque.

Default Value:	NA	Parameter Type:	Range (-300 — 300)
Parameter Number:	6152	Unit:	%
Data Type:	REAL	Access Type:	Read/Write

P 5.9.1.7 Torque Reference Final

Shows the value of the final torque reference given to the motor controller in % of nominal motor torque.

Default Value:	NA	Parameter Type:	Range (-300 — 300)
Parameter Number:	6154	Unit:	%
Data Type:	REAL	Access Type:	Read Only

6.6.10.3 Limits (Menu Index 5.9.2)**P 5.9.2.1 Positive Torque Limit**

Set the positive torque limit (quadrants 1 and 2) in % of nominal motor torque.

Default Value:	300	Parameter Type:	Range (0 — 500)
----------------	-----	-----------------	-----------------

Parameter Number: 1810	Unit: %
Data Type: REAL	Access Type: Read/Write

P 5.9.2.2 Negative Torque Limit

Set the negative torque limit (quadrants 3 and 4) in % of nominal motor torque.

Default Value: -300	Parameter Type: Range (-500 — 0)
Parameter Number: 1811	Unit: %
Data Type: REAL	Access Type: Read/Write

P 5.9.2.3 Motoring Torque Limit

Set the torque limit in motoring mode (quadrants 1 and 3) in % of nominal motor torque.

Default Value: 300	Parameter Type: Range (0 — 500)
Parameter Number: 1321	Unit: %
Data Type: REAL	Access Type: Read/Write

P 5.9.2.4 Regenerative Torque Limit

Set the torque limit in regenerative mode (quadrants 2 and 4) in % of nominal motor torque.

Default Value: 300	Parameter Type: Range (0 — 500)
Parameter Number: 1323	Unit: %
Data Type: REAL	Access Type: Read/Write

P 5.9.2.5 Speed Limit Mode Torque Ctrl.

Select the speed limiting mode during torque control.

Default Value: 0 (Pos./Neg. Speed Limit)	Parameter Type: Selection
Parameter Number: 2332	Unit: –
Data Type: UINT	Access Type: Read/Conditional Write

The following are the selections for the parameter.

Selection Number	Selection Name	Selection Description
0	Pos./Neg. Speed Limit	Limit between positive and negative speed limit.
1	Speed Limit Setpoint	Limit between +/- speed limit setpoint.
2	Window around Speed Limit Setpoint	Limit window around torque mode speed limit.

P 5.9.2.6 Lower Window Limit

Set the window size towards the positive speed direction.

Default Value: –	Parameter Type: Range (0 — 10)
Parameter Number: 2333	Unit: Hz
Data Type: REAL	Access Type: Read/Write

P 5.9.2.7 Upper Window Limit

Set the window size towards the negative speed direction.

Default Value:	–	Parameter Type:	Range (0 — 10)
Parameter Number:	2334	Unit:	Hz
Data Type:	REAL	Access Type:	Read/Write

P 5.9.2.26 Speed Limit Setpoint

Set the variable speed limit setpoint in torque mode. This is used when fixed speed limits are not desired.

Default Value:	50	Parameter Type:	Range (0 — 1000)
Parameter Number:	1336	Unit:	Hz
Data Type:	REAL	Access Type:	Read/Write

P 5.9.2.27 Speed Limit Setpoint Ramp Time

Set the speed limit setpoint ramp time. When running in speed limit in torque mode, the drive will accelerate/decelerate towards the speed limit setpoint using this ramp time.

Default Value:	5	Parameter Type:	Range (0 — 10000)
Parameter Number:	1337	Unit:	s
Data Type:	REAL	Access Type:	Read/Write

P 5.9.2.28 Motoring Torque Limit Scale Input

Select the input for scaling motoring torque limit between 0% and 100% value defined in motoring torque limit. Off equals 100%.

Default Value:	–	Parameter Type:	Selection
Parameter Number:	1324	Unit:	–
Data Type:	UINT	Access Type:	Read/Write

P 5.9.2.29 Regenerative Torque Limit Scale Input

Select the input for scaling regenerative torque limit between 0% and 100% value defined in regenerative torque limit. Off equals 100%.

Default Value:	–	Parameter Type:	Selection
Parameter Number:	1326	Unit:	–
Data Type:	UINT	Access Type:	Read/Write

P 5.9.2.30 Negative Torque Limit Scale Input

Select the input for scaling negative torque limit between 0% and 100% value defined in negative torque limit. Off equals 100%.

Default Value:	–	Parameter Type:	Selection
Parameter Number:	1330	Unit:	–
Data Type:	UINT	Access Type:	Read/Write

P 5.9.2.31 Positive Torque Limit Scale Input

Select the input for scaling positive torque limit between 0% and 100% value defined in positive torque limit. Off equals 100%.

Default Value:	–	Parameter Type:	Selection
Parameter Number:	1333	Unit:	–

Data Type:	UINT	Access Type:	Read/Write
-------------------	------	---------------------	------------

P 5.9.2.32 Speed Limit setpoint Scale Input

Select the input for scaling speed limit setpoint in torque mode between 0% and 100% of parameter value. Off equals 100%.

Default Value:	–	Parameter Type:	Selection
Parameter Number:	1334	Unit:	–
Data Type:	UINT	Access Type:	Read/Write

P 5.9.2.33 Motoring Torque Limit Response

Select the response for running in motoring torque limit after the time delay defined.

Default Value:	0 (No response)	Parameter Type:	Selection
Parameter Number:	2361	Unit:	–
Data Type:	UINT	Access Type:	Read/Write

The following are the selections for the parameter.

Selection Number	Selection Name	Selection Description
0	No response	The event is ignored.
1	Info	The event is logged in the event log.
10	Fault	The drive issues a fault and coasts the motor.

P 5.9.2.34 Motoring Torque Limit Delay

Set the delay the drive is allowed to be in motoring torque limit before a response is issued.

Default Value:	–	Parameter Type:	Range (0 — 65000)
Parameter Number:	2358	Unit:	s
Data Type:	REAL	Access Type:	Read/Write

P 5.9.2.35 Regenerative Torque Limit Response

Select the response for running in regenerative torque limit after the time delay defined.

Default Value:	0 (No response)	Parameter Type:	Selection
Parameter Number:	2362	Unit:	–
Data Type:	UINT	Access Type:	Read/Write

The following are the selections for the parameter.

Selection Number	Selection Name	Selection Description
0	No response	The event is ignored.
1	Info	The event is logged in the event log.
10	Fault	The drive issues a fault and coasts the motor.

P 5.9.2.36 Regenerative Torque Limit Delay

Set the delay the drive is allowed to be in regenerative torque limit before a response is issued.

Default Value:	–	Parameter Type:	Range (0 — 65000)
Parameter Number:	2363	Unit:	s
Data Type:	REAL	Access Type:	Read/Write

6.6.10.4 Torque Reference (Menu Index 5.9.3)

P 5.9.3.1 Torque Reference 1 Input

Select the input terminal or a predefined fixed value for the torque reference.

Default Value:	–	Parameter Type:	Selection
Parameter Number:	4534	Unit:	–
Data Type:	UINT	Access Type:	Read/Write



NOTE: Selection lists with inputs and/or outputs consist of the name of the hardware option and the numbers of the terminals. For example, terminal number 13 of the Basic I/O is called Basic I/O T13 in the selection list.

P 5.9.3.2 Torque Reference 2 Input

Select the input terminal or a predefined fixed value for the torque reference.

Default Value:	–	Parameter Type:	Selection
Parameter Number:	4535	Unit:	–
Data Type:	UINT	Access Type:	Read/Write



NOTE: Selection lists with inputs and/or outputs consist of the name of the hardware option and the numbers of the terminals. For example, terminal number 13 of the Basic I/O is called Basic I/O T13 in the selection list.

P 5.9.3.3 Torque Reference 1 Max.

Set the maximum torque reference value in % of nominal motor torque.

Default Value:	100	Parameter Type:	Range (-300 — 300)
Parameter Number:	4530	Unit:	%
Data Type:	REAL	Access Type:	Read/Write

P 5.9.3.4 Torque Reference 1 Min.

Set the minimum torque reference value in % of nominal motor torque.

Default Value:	–	Parameter Type:	Range (-300 — 300)
Parameter Number:	4531	Unit:	%
Data Type:	REAL	Access Type:	Read/Write

P 5.9.3.5 Torque Reference 2 Max.

Set the maximum torque reference value in % of nominal motor torque.

Default Value:	100	Parameter Type:	Range (-300 — 300)
-----------------------	-----	------------------------	--------------------

Parameter Number: 4532	Unit: %
Data Type: REAL	Access Type: Read/Write

P 5.9.3.6 Torque Reference 2 Min.

Set the torque minimum reference value in % of nominal motor torque.

Default Value: –	Parameter Type: Range (-300 — 300)
Parameter Number: 4533	Unit: %
Data Type: REAL	Access Type: Read/Write

P 5.9.3.7 Preset Torque Selector

Select the preset torque number.

Default Value: 1 (Preset 1)	Parameter Type: Selection
Parameter Number: 724	Unit: –
Data Type: UINT	Access Type: Read/Write

The following are the selections for the parameter.

Selection Number	Selection Name	Selection Description
0	Bit Selection	Use digital inputs to select the preset reference number.
1	Preset 1	Use preset 1.
2	Preset 2	Use preset 2.
3	Preset 3	Use preset 3.
4	Preset 4	Use preset 4.

P 5.9.3.8 Preset Torque 1

Set the torque preset value in % of the nominal motor torque.

Default Value: 10	Parameter Type: Range (-300 — 300)
Parameter Number: 725	Unit: %
Data Type: REAL	Access Type: Read/Write

P 5.9.3.9 Preset Torque 2

Set the torque preset value in % of the nominal motor torque.

Default Value: 25	Parameter Type: Range (-300 — 300)
Parameter Number: 726	Unit: %
Data Type: REAL	Access Type: Read/Write

P 5.9.3.10 Preset Torque 3

Set the torque preset value in % of the nominal motor torque.

Default Value: 50	Parameter Type: Range (-300 — 300)
Parameter Number: 727	Unit: %

Data Type:	REAL	Access Type:	Read/Write
-------------------	------	---------------------	------------

P 5.9.3.11 Preset Torque 4

Set the torque preset value in % of the nominal motor torque.

Default Value:	100	Parameter Type:	Range (-300 — 300)
Parameter Number:	728	Unit:	%
Data Type:	REAL	Access Type:	Read/Write

P 5.9.3.12 Preset Torque Bit 0 Input

Select the digital input used as bit 0 addressing the preset reference.

Default Value:	–	Parameter Type:	Selection
Parameter Number:	721	Unit:	–
Data Type:	UINT	Access Type:	Read/Write



NOTE: Selection lists with inputs and/or outputs consist of the name of the hardware option and the numbers of the terminals. For example, terminal number 13 of the Basic I/O is called Basic I/O T13 in the selection list.

P 5.9.3.13 Preset Torque Bit 1 Input

Select the digital input used as bit 1 addressing the preset reference.

Default Value:	–	Parameter Type:	Selection
Parameter Number:	722	Unit:	–
Data Type:	UINT	Access Type:	Read/Write



NOTE: Selection lists with inputs and/or outputs consist of the name of the hardware option and the numbers of the terminals. For example, terminal number 13 of the Basic I/O is called Basic I/O T13 in the selection list.

P 5.9.3.14 Torque Reference Ramp Time

Set the ramping time from 0 to nominal motor torque.

Default Value:	–	Parameter Type:	Range (0 — 10000)
Parameter Number:	2330	Unit:	s
Data Type:	REAL	Access Type:	Read/Write

P 5.9.3.15 Torque Ref. Lowpass Filter Tc

Set the time constant of the reference filter. Setting it to 0 disables the filter.

Default Value:	–	Parameter Type:	Range (0.00 — 1000000.00)
Parameter Number:	2335	Unit:	ms
Data Type:	REAL	Access Type:	Read/Write

6.6.11 Process Control (Menu Index 5.10)

6.6.11.1 Process Control Overview

The process controller enables maintaining process parameters such as temperature, pressure, and flow within a specified range or at a desired value. This is achieved by controlling the output frequency of the drive based on continuous measurement of the actual value of the process parameter (feedback) and the comparison of the process parameter with a setpoint.

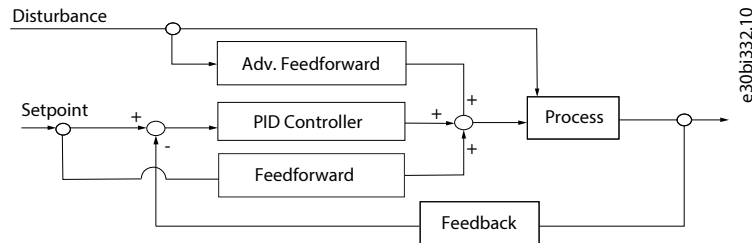

Figure 79: Process Controller

The embedded process controller features the following:

- Adjustable proportional gain, Integral time, and Derivative time
- Auto-tuning of the controller
- Bumpless operation
- 8 preset references
- 2 reference sources which can be combined
- Feedforward control
- Inverse control
- 2 feedback sources (analog inputs and fieldbus)
- Feedback calculations including sum, difference, average, minimum, and maximum
- Anti-windup
- Low-pass filtering of setpoint or feedback
- Status of the most important process parameters

6.6.11.2 Process Control Status (Menu Index 5.10.1)

P 5.10.1.1 On Reference

Shows if the controlled process is operating on the current reference.

Default Value:	NA	Parameter Type:	Range (False — True)
Parameter Number:	6074	Unit:	–
Data Type:	BOOL	Access Type:	Read Only

P 5.10.1.2 Process Controller Output

Shows the output of the process controller as normalized value (in the range 0 to 1).

Default Value:	NA	Parameter Type:	Range (-1000000 — 1000000)
Parameter Number:	6075	Unit:	–
Data Type:	REAL	Access Type:	Read Only

P 5.10.1.3 Setpoint Value

Shows the actual value of the setpoint.

Default Value:	NA	Parameter Type:	Range (-1000000 — 1000000)
Parameter Number:	6092	Unit:	–
Data Type:	REAL	Access Type:	Read Only

P 5.10.1.4 Feedback Value

Shows the actual value of the feedback.

Default Value:	NA	Parameter Type:	Range (* — *)
Parameter Number:	6090	Unit:	CustomProcessUnit
Data Type:	REAL	Access Type:	Read Only

P 5.10.1.5 Adv. Feedforward Value

Shows the actual value of the advanced feedforward.

Default Value:	NA	Parameter Type:	Range (-1000000 — 1000000)
Parameter Number:	6086	Unit:	–
Data Type:	REAL	Access Type:	Read Only

P 5.10.1.6 Feedback 1 Value

Shows the actual value of feedback 1.

Default Value:	NA	Parameter Type:	Range (-1000000 — 1000000)
Parameter Number:	6080	Unit:	–
Data Type:	REAL	Access Type:	Read Only

P 5.10.1.7 Feedback 2 Value

Shows the actual value of feedback 2.

Default Value:	NA	Parameter Type:	Range (-1000000 — 1000000)
Parameter Number:	6085	Unit:	CustomProcessUnit
Data Type:	REAL	Access Type:	Read Only

P 5.10.1.9 Control Panel Process Reference

Shows the value of the process reference given from the control panel.

Default Value:	NA	Parameter Type:	Range (-1000000 — 1000000)
Parameter Number:	6094	Unit:	CustomProcessUnit
Data Type:	REAL	Access Type:	Read/Write

P 5.10.1.10 Process Controller Enabled

Enables the process controller.

Default Value:	NA	Parameter Type:	Range (False — True)
Parameter Number:	6053	Unit:	–
Data Type:	BOOL	Access Type:	Read Only

6.6.11.3 General Settings (Menu Index 5.10.2)

P 5.10.2.1 On Reference Relative Tolerance

Set the bandwidth for "On Reference" as % of the set point. If the control error is less than the defined percentage of the set point the "On Reference" flag is true. The tolerance used is the highest value of the absolute and relative reference.

Default Value:	0.01	Parameter Type:	Range (0 — 1)
Parameter Number:	6050	Unit:	PercentageFromFraction
Data Type:	REAL	Access Type:	Read/Write

P 5.10.2.2 On Reference Absolute Tolerance

Set the bandwidth for "On Reference" as an absolute value. If the control error is less than the defined percentage of the set point the "On Reference" flag is true. The tolerance used is the highest value of the absolute and relative reference.

Default Value:	0.01	Parameter Type:	Range (0 — 100000)
Parameter Number:	6064	Unit:	–
Data Type:	REAL	Access Type:	Read/Write

P 5.10.2.3 Process Unit

Unit of the Process Controller references and feedbacks (no automatic conversion is done when changing the value of this parameter).

Default Value:	31 ()	Parameter Type:	Selection
Parameter Number:	6628	Unit:	–
Data Type:	USINT	Access Type:	Read/Write

The following are the selections for the parameter.

Selection Number	Selection Name	Selection Description
31		Process Unit (No Unit or Custom Process Unit).
0	mbar	Pressure in millibars.
1	bar	Pressure in bars.
2	Pa	Pressure in pascals.
3	kPa	Pressure in kilopascals.
4	l/s	Liters per second.
5	l/min	Liters per minute.
6	l/h	Liters per hour.
7	m ³ /s	Cubic meters per second.
8	m ³ /min	Cubic meters per minute.
9	m ³ /h	Cubic meters per hour.
10	U.S. gallon/s (GPS)	U.S. gallons per second.
11	U.S. gallon/min (GPM)	U.S. gallons per minute.
12	U.S. gallon/h (GPH)	U.S. gallons per hour.
13	in ³ /s	Cubic inches per second.
14	in ³ /min	Cubic inches per minute.

Selection Number	Selection Name	Selection Description
15	in ³ /h	Cubic inches per hour.
16	ft ³ /s	Cubic feet per second.
17	ft ³ /min	Cubic feet per minute.
18	ft ³ /h	Cubic feet per hour.
19	m WG	Meter water gauge.
20	mm Hg	Millimeters of mercury.
21	°C	Degrees Celcius.
22	°F	Degrees Fahrenheit.
23	kg/s	Kilograms per second.
24	kg/min	Kilograms per minute.
25	kg/h	Kilograms per hour.
26	t/min	Tons per minute.
27	t/h	Tons per hour.
28	m/s	Meters per second.
29	m/min	Meters per minute.
30	m/h	Meters per hour.
32	psi	lb/in ² .
33	in WG	Inches of water.
34	in Hg	Inches of mercury.
35	ft WG	Feet of water.

6.6.11.4 Process Reference (Menu Index 5.10.3)

P 5.10.3.1 Process Reference Max. Limit

Set the maximum value of the reference. It defines the upper point for the limiting of the reference input.

Default Value:	10	Parameter Type:	Range (-1000000 — 1000000)
Parameter Number:	6013	Unit:	CustomProcessUnit
Data Type:	REAL	Access Type:	Read/Write

P 5.10.3.2 Process Reference Min. Limit

Set the minimum value of the reference. It defines the lower point for the limiting of the reference input.

Default Value:	–	Parameter Type:	Range (-1000000 — 1000000)
Parameter Number:	6014	Unit:	CustomProcessUnit
Data Type:	REAL	Access Type:	Read/Write

P 5.10.3.3 Process Reference 1 Input

Select the input terminal or a predefined fixed value for the process reference.

Default Value:	–	Parameter Type:	Selection
-----------------------	---	------------------------	-----------

Parameter Number: 6025	Unit: –
Data Type: UINT	Access Type: Read/Write

P 5.10.3.4 Process Reference 2 Input

Select the input terminal or a predefined fixed value for the the process reference.

Default Value: –	Parameter Type: Selection
Parameter Number: 6026	Unit: –
Data Type: UINT	Access Type: Read/Write

P 5.10.3.5 Process Reference 1 Min.

Set the minimum process reference for the input.

Default Value: –	Parameter Type: Range (-1000000 — 1000000)
Parameter Number: 6047	Unit: CustomProcessUnit
Data Type: REAL	Access Type: Read/Write

P 5.10.3.6 Process Reference 1 Max.

Set the maximum process reference for the input.

Default Value: 10	Parameter Type: Range (-1000000 — 1000000)
Parameter Number: 6048	Unit: CustomProcessUnit
Data Type: REAL	Access Type: Read/Write

P 5.10.3.7 Process Reference 2 Min.

Set the minimum process reference for the input.

Default Value: –	Parameter Type: Range (-1000000 — 1000000)
Parameter Number: 6033	Unit: CustomProcessUnit
Data Type: REAL	Access Type: Read/Write

P 5.10.3.8 Process Reference 2 Max.

Set the maximum process reference for the input.

Default Value: 10	Parameter Type: Range (-1000000 — 1000000)
Parameter Number: 6029	Unit: CustomProcessUnit
Data Type: REAL	Access Type: Read/Write

P 5.10.3.9 Preset Process Reference Selector

Select the preset reference. The preset reference can be selected as a fixed value or by 3 digital inputs.

Default Value: 1 (Preset 1)	Parameter Type: Selection
Parameter Number: 6032	Unit: –
Data Type: UINT	Access Type: Read/Write

The following are the selections for the parameter.

Selection Number	Selection Name	Selection Description
0	Bit Selection	Use digital inputs to select the preset reference number.
1	Preset 1	Use preset 1.
2	Preset 2	Use preset 2.
3	Preset 3	Use preset 3.
4	Preset 4	Use preset 4.
5	Preset 5	Use preset 5.
6	Preset 6	Use preset 6.
7	Preset 7	Use preset 7.
8	Preset 8	Use preset 8.

P 5.10.3.10 Preset Process Ref. Bit 0 Input

Select the digital input used as bit 0 addressing the preset reference.

Default Value:	–	Parameter Type:	Selection
Parameter Number:	6034	Unit:	–
Data Type:	UINT	Access Type:	Read/Write

P 5.10.3.11 Preset Process Ref. Bit 1 Input

Select the digital input used as bit 1 addressing the preset reference.

Default Value:	–	Parameter Type:	Selection
Parameter Number:	6035	Unit:	–
Data Type:	UINT	Access Type:	Read/Write

P 5.10.3.12 Preset Process Ref. Bit 2 Input

Select the digital input used as bit 2 addressing the preset reference.

Default Value:	–	Parameter Type:	Selection
Parameter Number:	6036	Unit:	–
Data Type:	UINT	Access Type:	Read/Write

P 5.10.3.13 Preset Process Ref. 1

Set the value of the preset reference.

Default Value:	1	Parameter Type:	Range (-1000000 — 1000000)
Parameter Number:	6037	Unit:	CustomProcessUnit
Data Type:	REAL	Access Type:	Read/Write

P 5.10.3.14 Preset Process Ref. 2

Set the value of the preset reference.

Default Value:	2	Parameter Type:	Range (-1000000 — 1000000)
Parameter Number:	6038	Unit:	CustomProcessUnit

Data Type:	REAL	Access Type:	Read/Write
-------------------	------	---------------------	------------

P 5.10.3.15 Preset Process Ref. 3

Set the value of the preset reference.

Default Value:	3	Parameter Type:	Range (-1000000 — 1000000)
Parameter Number:	6039	Unit:	CustomProcessUnit
Data Type:	REAL	Access Type:	Read/Write

P 5.10.3.16 Preset Process Ref. 4

Set the value of the preset reference.

Default Value:	4	Parameter Type:	Range (-1000000 — 1000000)
Parameter Number:	6040	Unit:	CustomProcessUnit
Data Type:	REAL	Access Type:	Read/Write

P 5.10.3.17 Preset Process Ref. 5

Set the value of the preset reference.

Default Value:	5	Parameter Type:	Range (-1000000 — 1000000)
Parameter Number:	6041	Unit:	CustomProcessUnit
Data Type:	REAL	Access Type:	Read/Write

P 5.10.3.18 Preset Process Ref. 6

Set the value of the preset reference.

Default Value:	6	Parameter Type:	Range (-1000000 — 1000000)
Parameter Number:	6042	Unit:	CustomProcessUnit
Data Type:	REAL	Access Type:	Read/Write

P 5.10.3.19 Preset Process Ref. 7

Set the value of the preset reference.

Default Value:	7	Parameter Type:	Range (-1000000 — 1000000)
Parameter Number:	6043	Unit:	CustomProcessUnit
Data Type:	REAL	Access Type:	Read/Write

P 5.10.3.20 Preset Process Ref. 8

Set the value of the preset reference.

Default Value:	8	Parameter Type:	Range (-1000000 — 1000000)
Parameter Number:	6044	Unit:	CustomProcessUnit
Data Type:	REAL	Access Type:	Read/Write

P 5.10.3.21 Process Ref. Ramp Rise Time

Set the rising rate of the ramp for the setpoint.

Default Value:	10000	Parameter Type:	Range (0 — 1000000)
Parameter Number:	6005	Unit:	–
Data Type:	REAL	Access Type:	Read/Write

P 5.10.3.22 Process Ref. Ramp Fall Time

Set the falling rate of the ramp for the setpoint.

Default Value:	10000	Parameter Type:	Range (0 — 1000000)
Parameter Number:	6006	Unit:	–
Data Type:	REAL	Access Type:	Read/Write

Editing the setpoint falling time ramp defines the ramp-down time. The falling ramp for the setpoint is defined as slew rates which refers to process unit per time such as bar/s, °C/s. Setting the parameter to high values (compared to the dynamics of the requested setpoint) disables the ramp-down function.

P 5.10.3.23 Process Ref. Lowpass Filter Tc

Set the time constant of the reference filter. Setting it to 0 disables the filter.

Default Value:	–	Parameter Type:	Range (0.00 — 30000.00)
Parameter Number:	6083	Unit:	ms
Data Type:	REAL	Access Type:	Read/Write

P 5.10.3.24 Process Controller Start Speed

Set the start speed of the process controller.

Default Value:	–	Parameter Type:	Range (-1000 — 1000)
Parameter Number:	6056	Unit:	Hz
Data Type:	REAL	Access Type:	Read/Write

P 5.10.3.26 Fieldbus Process Reference Scale

Set the fieldbus reference scale equal to 100% reference.

Default Value:	10	Parameter Type:	Range (-1000000 — 1000000)
Parameter Number:	6030	Unit:	CustomProcessUnit
Data Type:	REAL	Access Type:	Read/Write

6.6.11.5 Feedback (Menu Index 5.10.4)

P 5.10.4.1 Feedback Mode

Select the function to combine feedback 1 and feedback 2.

Default Value:	0 (Feedback 1)	Parameter Type:	Selection
Parameter Number:	6008	Unit:	–
Data Type:	UINT	Access Type:	Read/Write

The following are the selections for the parameter.

Selection Number	Selection Name	Selection Description
0	Feedback 1	Use value from feedback source 1 only.
1	Feedback 2	Use value from feedback source 2 only.
2	Sum	Add references from source 1 and 2 together.
3	Difference	Subtract source 2 from source 1.
4	Average	Average value of source 1 and 2.
5	Minimum	Use lowest value of source 1 and source 2.
6	Maximum	Use highest value of source 1 and source 2.

P 5.10.4.2 Feedback 1 Type

Select the type of feedback.

Default Value:	1 (Analog Feedback Terminal)	Parameter Type:	Selection
Parameter Number:	6021	Unit:	–
Data Type:	UINT	Access Type:	Read/Write

The following are the selections for the parameter.

Selection Number	Selection Name	Selection Description
0	Feedback disabled	
1	Analog Feedback Terminal	Use feedback value from the analog input.
2	Fieldbus Feedback	Use feedback value from the fieldbus.

P 5.10.4.3 Feedback 1 Maximum Scaling

Set the maximum scaling value of the feedback.

Default Value:	10	Parameter Type:	Range (-1000000 — 1000000)
Parameter Number:	6015	Unit:	CustomProcessUnit
Data Type:	REAL	Access Type:	Read/Write

P 5.10.4.4 Feedback 1 Minimum Scaling

Set the minimum scaling value of the feedback.

Default Value:	–	Parameter Type:	Range (-1000000 — 1000000)
Parameter Number:	6016	Unit:	CustomProcessUnit
Data Type:	REAL	Access Type:	Read/Write

P 5.10.4.5 Analog Input Feedback 1

Select the input or a predefined fixed value for the feedback.

Default Value:	–	Parameter Type:	Selection
Parameter Number:	6027	Unit:	–
Data Type:	UINT	Access Type:	Read/Write

P 5.10.4.6 Feedback 1 Conversion

Select a conversion function for the feedback.

Default Value:	0 (Linear)	Parameter Type:	Selection
Parameter Number:	6009	Unit:	–
Data Type:	UINT	Access Type:	Read/Write

The following are the selections for the parameter.

Selection Number	Selection Name	Selection Description
0	Linear	The feedback value is not converted.
1	Quadratic	The feedback value is converted by the square root of the value.

P 5.10.4.7 Feedback 2 Type

Select the type of feedback.

Default Value:	0 (Feedback disabled)	Parameter Type:	Selection
Parameter Number:	6022	Unit:	–
Data Type:	UINT	Access Type:	Read/Write

The following are the selections for the parameter.

Selection Number	Selection Name	Selection Description
0	Feedback disabled	
1	Analog Feedback Terminal	Use feedback value from the analog input.
2	Fieldbus Feedback	Use feedback value from the fieldbus.

P 5.10.4.8 Feedback 2 Maximum Scaling

Set the maximum scaling value of the feedback.

Default Value:	100	Parameter Type:	Range (-1000000 — 1000000)
Parameter Number:	6017	Unit:	CustomProcessUnit
Data Type:	REAL	Access Type:	Read/Write

P 5.10.4.9 Feedback 2 Minimum Scaling

Set the minimum scaling value of the feedback.

Default Value:	–	Parameter Type:	Range (-1000000 — 1000000)
Parameter Number:	6018	Unit:	CustomProcessUnit
Data Type:	REAL	Access Type:	Read/Write

P 5.10.4.10 Analog Input Feedback 2

Set the input for the feedback.

Default Value:	–	Parameter Type:	Selection
-----------------------	---	------------------------	-----------

Parameter Number: 6028	Unit: –
Data Type: UINT	Access Type: Read/Write

P 5.10.4.11 Feedback 2 Conversion

Select a conversion function for the feedback.

Default Value: 0 (Linear)	Parameter Type: Selection
Parameter Number: 6010	Unit: –
Data Type: UINT	Access Type: Read/Write

The following are the selections for the parameter.

Selection Number	Selection Name	Selection Description
0	Linear	The feedback value is not converted.
1	Quadratic	The feedback value is converted by the square root of the value.

P 5.10.4.17 Feedback Filter Tc

Set the time constant of the feedback filter.

Default Value: –	Parameter Type: Range (0.00 — 30000.00)
Parameter Number: 6084	Unit: ms
Data Type: REAL	Access Type: Read/Write

6.6.11.6 PID Controller (Menu Index 5.10.5)

P 5.10.5.1 Proportional Gain

Set the propoportional gain of the PID controller.

Default Value: 10	Parameter Type: Range (0 — 100000)
Parameter Number: 6065	Unit: –
Data Type: REAL	Access Type: Read/Write

P 5.10.5.2 Integral Time

Set the integral time of the PID controller.

Default Value: 1	Parameter Type: Range (0 — 1000000)
Parameter Number: 6058	Unit: s
Data Type: REAL	Access Type: Read/Write

P 5.10.5.3 Integral Reset

Resets the I-part of the PID controller. The selection automatically returns to false. Resetting the I-part makes it possible to start from a well-defined point after changing something in the process.

Default Value: False	Parameter Type: Range (False — True)
Parameter Number: 6060	Unit: –
Data Type: BOOL	Access Type: Read/Write

P 5.10.5.4 Antiwindup Enabled

Enables antiwindup which ceases the regulation of an error, when the minimum or maximum speed is reached.

Default Value:	1	Parameter Type:	Range (False — True)
Parameter Number:	6061	Unit:	–
Data Type:	BOOL	Access Type:	Read/Write

P 5.10.5.5 Derivative Time

Set the derivative time of the PID controller. The differentiator does not react to a constant error, but provides a gain only when the error changes. The shorter the PID differentiation time, the stronger the gain from the differentiator. When set to 0 the derivative part is disabled.

Default Value:	–	Parameter Type:	Range (0 — 1000)
Parameter Number:	6068	Unit:	s
Data Type:	REAL	Access Type:	Read/Write

P 5.10.5.6 Derivative Gain

Set a limit for the differentiator gain. If there is no limit, the differentiator gain increases when there are fast changes. To obtain a pure differentiator gain at slow changes and a constant differentiator gain where fast changes occur, limit the differentiator gain.

Default Value:	5	Parameter Type:	Range (1 — 100)
Parameter Number:	6069	Unit:	–
Data Type:	REAL	Access Type:	Read/Write

P 5.10.5.7 PID Inverted

Inverts the output of the PID controller.

Default Value:	False	Parameter Type:	Range (False — True)
Parameter Number:	6066	Unit:	–
Data Type:	BOOL	Access Type:	Read/Write

6.6.11.7 Feedforward Controller (Menu Index 5.10.6)

P 5.10.6.1 Feedforward Factor

Set the PID feedforward factor. The factor sends a constant fraction of the reference signal to bypass the PID control. The feedforward factor provides less overshoot and higher dynamics when the reference is changed.

Default Value:	–	Parameter Type:	Range (0 — 10000)
Parameter Number:	6063	Unit:	–
Data Type:	REAL	Access Type:	Read/Write

Feedforward is activated when this parameter is set to a value higher than 0. Enter the value in percentage. The factor sends a constant fraction of the reference signal to bypass the PID control. When the feedforward factor is activated, the process control provides less overshoot and improves the control performance (better step response) when the setpoint changes.

P 5.10.6.2 Adv. Feedforward Maximum

Set the advanced feedforward scaling value that corresponds to the maximum value for its selected reference source.

Default Value:	10	Parameter Type:	Range (-1000000 — 1000000)
Parameter Number:	6011	Unit:	–
Data Type:	REAL	Access Type:	Read/Write

P 5.10.6.3 Adv. Feedforward Minimum

Set the advanced feedforward scaling value that corresponds to the minimum value for its selected reference source.

Default Value:	–	Parameter Type:	Range (-1000000 — 1000000)
Parameter Number:	6012	Unit:	–
Data Type:	REAL	Access Type:	Read/Write

P 5.10.6.4 Adv. Feedforward Ref. Mode

Select the reference source for the advanced feedforward controller.

Default Value:	0 (None)	Parameter Type:	Selection
Parameter Number:	6019	Unit:	–
Data Type:	UINT	Access Type:	Read/Write

The following are the selections for the parameter.

Selection Number	Selection Name	Selection Description
0	None	No source selected equals a 0 value.
1	Reference 1 input	Use the reference from I/O reference 1.
2	Reference 2 input	Use the reference from I/O reference 2.
3	Analog Input Reference 1+2	Use the sum of values from I/O source 1 and 2 as reference source.
4	Fieldbus Reference	Use the value from the fieldbus as reference source.

P 5.10.6.5 Adv. Feedforward AI 1 Ref.

Select the input for the reference number 1 of the advanced feedforward controller.

Default Value:	0	Parameter Type:	Range (0 — 29999)
Parameter Number:	6023	Unit:	–
Data Type:	UINT	Access Type:	Read/Write

P 5.10.6.6 Adv. Feedforward AI 2 Ref.

Set the input for the reference number 2 of the advanced feedforward controller.

Default Value:	0	Parameter Type:	Range (0 — 29999)
Parameter Number:	6024	Unit:	–
Data Type:	UINT	Access Type:	Read/Write

P 5.10.6.7 Adv. Feedforward Inverted

Inverts the reaction of the advanced feedforward controller.

Default Value:	False	Parameter Type:	Range (False — True)
-----------------------	-------	------------------------	----------------------

Parameter Number: 6073	Unit: –
Data Type: BOOL	Access Type: Read/Write

6.6.11.8 Auto Tuning (Menu Index 5.10.7)

P 5.10.7.1 Process Controller Auto Tuning

Enables the auto tuning procedure of the process controller. Requires start signal and returns to false after completion.

Default Value: False	Parameter Type: Selection
Parameter Number: 6901	Unit: –
Data Type: BOOL	Access Type: Read/Write

The following are the selections for the parameter.

Selection Number	Selection Name	Selection Description
0	Disabled	Disables the function.
1	Enabled	Enables the function.

P 5.10.7.2 Auto Tuning Reference

Set the reference point where the auto tuning is executed. Values are entered in process units.

Default Value: –	Parameter Type: Range (-1000000 — 1000000)
Parameter Number: 6902	Unit: CustomProcessUnit
Data Type: REAL	Access Type: Read/Write

P 5.10.7.3 Closed Loop Type

Selects the time constant "tau" of your system. It should be set up like this: <10s - FAST PRESSURE, 10-30s - SLOW PRESSURE, 30-600s - FAST TEMPERATURE, >600s - SLOW TEMPERATURE.

Default Value: 10 (Fast Pressure)	Parameter Type: Selection
Parameter Number: 7000	Unit: –
Data Type: UINT	Access Type: Read/Write

The following are the selections for the parameter.

Selection Number	Selection Name	Selection Description
10	Fast Pressure	
30	Slow Pressure	
600	Fast Temperature	
1800	Slow Temperature	

6.6.12 Inching (Menu Index 5.11)

P 5.11.1 Inching Mode

Select the inching mode. Inching is used for operating the motor for periods with a specific inching reference.

Default Value:	1 (Jogging Mode)	Parameter Type:	Selection
Parameter Number:	1081	Unit:	–
Data Type:	UINT	Access Type:	Read/Write

The following are the selections for the parameter.

Selection Number	Selection Name	Selection Description
0	Slow Down Mode	Reduce speed to inching speed. If inching is activated in this mode motor speed is limited to inching reference in same direction as the reference.
1	Jogging Mode	Jogging will start drive and run at defined inching speed. Jogging will be ignored if drive is already running or if stop or coast is activated.
2	Override Mode	Override mode, will run the override the reference with the reference defined as inching speed.

P 5.11.2 Enable Inching Input

Select a terminal to enable inching.

Default Value:	–	Parameter Type:	Selection
Parameter Number:	1080	Unit:	–
Data Type:	UINT	Access Type:	Read/Write

P 5.11.3 Inching Ramp Time

Set the ramp time for inching.

Default Value:	10	Parameter Type:	Range (0.01 — 3600)
Parameter Number:	1083	Unit:	s
Data Type:	REAL	Access Type:	Read/Write

P 5.11.4 Inching Reference 1

Set reference 1 for inching.

Default Value:	15	Parameter Type:	Range (-1000 — 1000)
Parameter Number:	1082	Unit:	Hz
Data Type:	REAL	Access Type:	Read/Write

P 5.11.5 Inching Activate Input 1

Select the terminal to inching with reference 1. Enable inching input must be active.

Default Value:	–	Parameter Type:	Selection
Parameter Number:	1084	Unit:	–
Data Type:	UINT	Access Type:	Read/Write

P 5.11.6 Inching Reference 2

Set reference 2 for inching.

Default Value:	-15	Parameter Type:	Range (-1000 — 1000)
Parameter Number:	1085	Unit:	Hz
Data Type:	REAL	Access Type:	Read/Write

P 5.11.7 Inching Activate Input 2

Select the terminal to inching with reference 2. Enable inching input must be active.

Default Value:	–	Parameter Type:	Selection
Parameter Number:	1086	Unit:	–
Data Type:	UINT	Access Type:	Read/Write

P 5.11.8 Inching Active Output

Select the output terminal or status bit indicating that inching is active.

Default Value:	–	Parameter Type:	Selection
Parameter Number:	1087	Unit:	–
Data Type:	UINT	Access Type:	Read/Write

6.6.13 Mechanical Brake Control (Menu Index 5.12)

6.6.13.1 Mechanical Brake Control Overview

The feature controls opening and closing of the mechanical brake and ensures the smooth transition of load between drive and mechanical brake. The mechanical brake holds the load when the drive is not running. The mechanical brake can be closed or released by controlling the torque, speed, and position. The feature supports the following load types:

- **Unidirectional load:** Typically used in scenarios when the load moves in the same direction such as in conveyors, winches, crane applications.
- **Bidirectional load:** Typically used in scenarios when the direction of the load is not known during startup, such as in elevator applications.

The mechanical brake control supports the following functions:

- 2 channels for mechanical braking feedback to offer further protection against unintended behavior resulting from broken cable.
- Monitoring of mechanical braking feedback throughout the complete cycle. Monitoring helps to protect the mechanical brake, especially if more drives are connected to the same shaft.
- No ramp-up until feedback confirms that mechanical brake is open.
- Improved load control at stop. If the value of the delay is too low, a warning is issued and the torque is not allowed to ramp down.
- The transition when motor takes over the load from the brake can be configured. Parameter **Release Bandwidth** can be increased to minimize the movement.

To achieve smooth transition, change the setting from speed control to position control during the changeover.

Starting with mechanical brake

- The motor must be primed by gradually applying a holding torque against the brake so that the torque step is minimized when the brake is released.

- When the configured torque is applied and priming time has passed, the brake is released. The torque and priming time is set via parameters **5.12.2.2 Brake Priming Torque** and **5.12.2.4 Brake Priming Time**. After priming, the brake is released.
- There is a physical delay between the electrical release of the brake and the physical release of the brake. This is referred to as brake release time and is set via the parameter **5.12.2.6 Brake Release Time**. When this happens, the load is shifted from the mechanical brake to the motor instantaneously.

Stopping with mechanical brake

- When stopping, the mechanical brake control monitors the motor speed and ramps down to 0 speed to close the brake.
- When closing speed is reached, the brake is activated, and the motor is held at 0 speed while the brake physically closes.
- When the brake is closed, torque is ramped down to 0, gradually shifting the load from motor to brake.

The following images represent the different functions of Mechanical Brake Control.

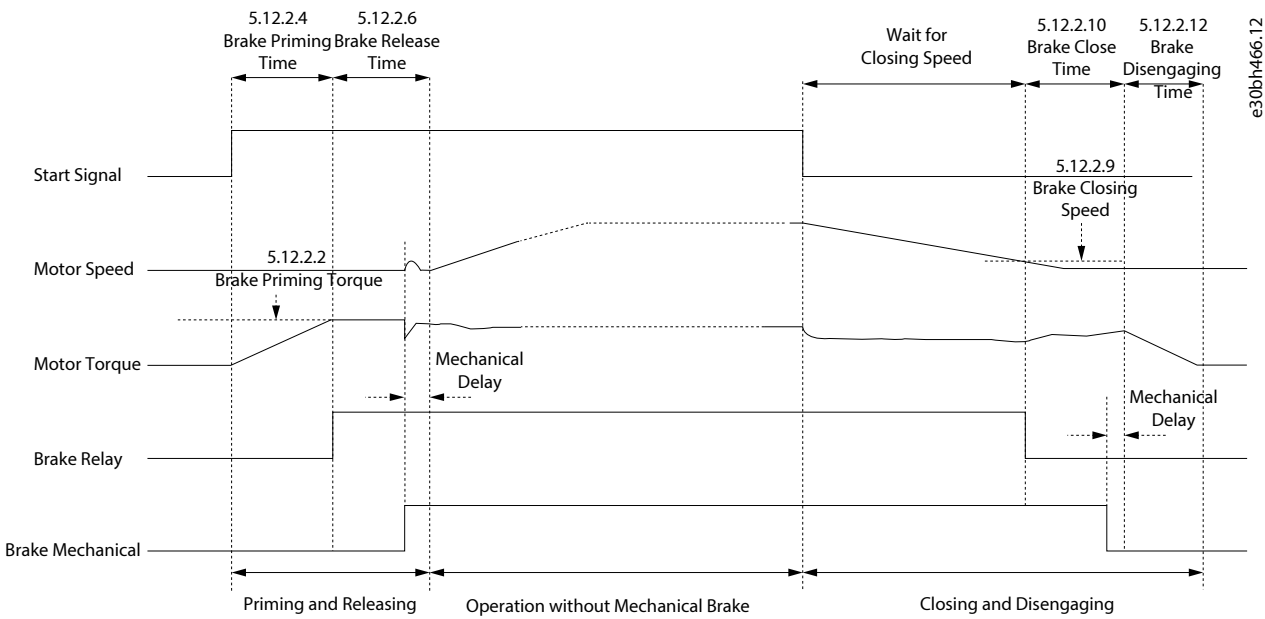

Figure 80: Mechanical Brake Control without Hovering

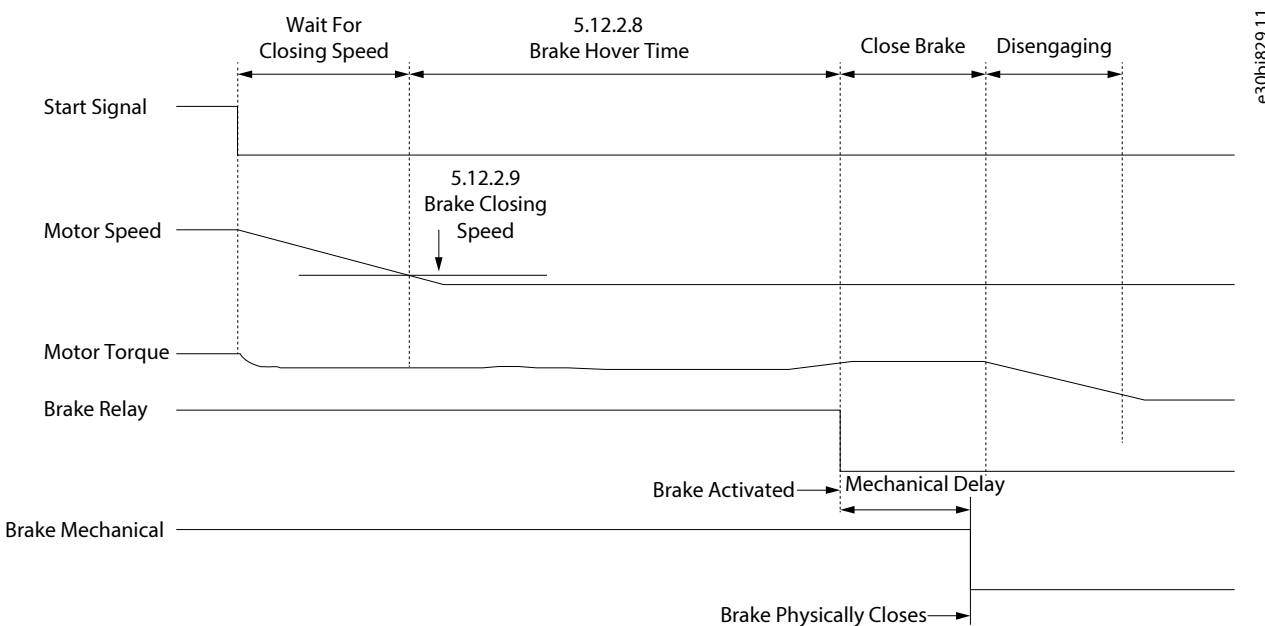

Figure 81: Mechanical Brake Control with Hovering

The following features are part of mechanical brake control:

- **Control:** Control brake via digital output and relay.
- **Optimization:** Automatically adapts to motor construction and control principle.
- **Feedback:** Supports digital brake feedback for open and closed loop, which provides faster control and monitoring.
- User configuration of mechanical brake control via parameters.
 - Digital inputs for brake feedback
 - Timeouts for release and close when using brake feedback
 - Digital output/relay for the mechanical brake
 - Timing and direction of applied torque for engaging or disengaging the mechanical brake
 - Mechanical brake release and close time
 - Hover delay
 - Brake close speed
 - Priming timeout



NOTE: Mechanical Brake Control requires operation in FVC+.

6.6.13.2 Mechanical Brake Control Status (Menu Index 5.12.1)

P 5.12.1.1 Mechanical Brake Status Word

Shows the mechanical brake status word.

Default Value:	NA	Parameter Type:	Range (* — *)
Parameter Number:	3016	Unit:	–
Data Type:	WORD	Access Type:	Read Only

Table 43: Status Word Description

Bit Number	Bit Name	Description
0	Enabled	The mechanical brake is enabled by a parameter.
1	Start	A start signal is provided to mechanical brake control.
2	Brake open feedback signal	Brake feedback is enabled and brake open is active.
3	Brake close feedback	Brake feedback is enabled and brake closed is active.
4–8	N/A	
9	Brake slip error	A higher slip than the defined limit has been detected in the mechanical brake.
10	Brake feedback state error	Both brake open and brake closed feedback signals are active at the same time.
11	Priming	The required release torque could not be generated.
12	Brake release timeout	Feedback is enabled but the brake open feedback signal was not provided during brake release time.
13	Brake close timeout	Feedback is enabled but the brake closed feedback signal was not provided during brake close time.
14	BrakeCtrl active	Brake control is either opening or closing the brake.
15	Brake open	Brake control has activated the digital output.

P 5.12.1.2 Mechanical Brake State

Shows the state of the mechanical brake controller.

Default Value:	NA	Parameter Type:	Range (0 — 32767)
Parameter Number:	3017	Unit:	–
Data Type:	INT	Access Type:	Read Only

P 5.12.1.3 Brake Release Time Detected

Shows the time from brake release until load change is detected, where motor takes over the load from mechanical brake.

Default Value:	NA	Parameter Type:	Range (0 — 10000)
Parameter Number:	3041	Unit:	s
Data Type:	REAL	Access Type:	Read Only

6.6.13.3 Mechanical Brake Slip Control

Mechanical brake slip control detects if the motor shaft moves while the mechanical brake is applied and reacts with a configurable response. The feature is used, for example, for controlling brake slip in crane and hoist applications.

Mechanical brake slip control can only be used in a closed loop with the FVC+ control principle and encoder configuration.

Mechanical brake slip control is configured with the Brake Settings parameters [5.12.2.21 Brake Slip Detection Response](#) and [5.12.2.22 Brake Slip Limit](#).

6.6.13.4 Brake Settings (Menu Index 5.12.2)

P 5.12.2.1 Brake Output

Select the output terminal for controlling the mechanical brake.

Default Value:	–	Parameter Type:	Selection
Parameter Number:	3007	Unit:	–
Data Type:	UINT	Access Type:	Read/Conditional Write

0 Indicates that the mechanical brake is disabled. Use the value 10105 to set a digital output where 1 refers to the control board, 01 refers to the option, and 05 refers to the terminal number.

Additional selections appear based on the hardware of the options connected to the drive and the available fieldbuses.

P 5.12.2.2 Brake Priming Torque

Set the torque to be build up against the mechanical brake during priming before releasing the brake.

Default Value:	100	Parameter Type:	Range (0 — 200)
Parameter Number:	3012	Unit:	%
Data Type:	REAL	Access Type:	Read/Write

The value is set as percent of nominal torque. The value defines the torque applied against the closed mechanical brake before release. The torque/load on a crane is positive and is 10– 160%. To obtain the best starting point, set the parameter to approximately 70%.

The torque/load on a lift can be both positive and negative and between -160% and +160%. To obtain the best starting point, set the parameter to 0%. The higher the torque error, the more movement during load takeover.

P 5.12.2.3 Brake Priming Direction

Select the direction of the applied torque during priming before releasing the brake.

Default Value:	0 (Clockwise)	Parameter Type:	Selection
Parameter Number:	3001	Unit:	–
Data Type:	UINT	Access Type:	Read/Write

The following are the selections for the parameter.

Selection Number	Selection Name	Selection Description
0	Clockwise	Holding torque is applied in clockwise direction prior to opening the brake.
1	Counter clockwise	Holding torque is applied in counter clockwise direction prior to opening the brake.
2	Reference Direction	Holding torque is applied in same direction as the reference prior to opening the brake.

P 5.12.2.4 Brake Priming Time

Set the priming time duration.

Default Value:	0.2	Parameter Type:	Range (0 — 5)
Parameter Number:	3000	Unit:	s
Data Type:	REAL	Access Type:	Read/Write

The value in the parameter defines the duration of the torque ramp up in clockwise direction.

P 5.12.2.5 Brake Priming Timeout

Set the time after which a warning is generated if priming cannot be finalized.

Default Value:	5	Parameter Type:	Range (2 — 10)
Parameter Number:	3006	Unit:	s
Data Type:	REAL	Access Type:	Read/Write

P 5.12.2.6 Brake Release Time

Set the time it takes for the mechanical brake to open and to release the load.

Default Value:	0.5	Parameter Type:	Range (0.1 — 30)
Parameter Number:	3003	Unit:	s
Data Type:	REAL	Access Type:	Read/Write

The value of the parameter defines the time taken for the mechanical brake to open. The configuration of the parameter acts as a timeout when brake feedback is activated.

P 5.12.2.7 Brake Open Input

Select the input terminal for an open indication signal from the mechanical brake.

Default Value:	–	Parameter Type:	Selection
Parameter Number:	3010	Unit:	–

Data Type:	UINT	Access Type:	Read/Write
-------------------	------	---------------------	------------

P 5.12.2.8 Brake Hover Time

Set the hover time. Hover time is the duration where the drive holds the load before the mechanical brake closes to allow an instant restart.

Default Value:	–	Parameter Type:	Range (0 — 60)
Parameter Number:	3013	Unit:	s
Data Type:	REAL	Access Type:	Read/Write

Defines the time at 0 speed. The value of the parameter defines the time interval from the moment when the motor is stopped until the brake closes. To adjust the transition of the load to the mechanical brake, set both Brake Close Time and Hover Time parameters. This parameter is a part of the stop function.

P 5.12.2.9 Brake Closing Speed

Set the speed at which the brake gets active (control terminal goes low).

Default Value:	5	Parameter Type:	Range (0 — 25)
Parameter Number:	3002	Unit:	Hz
Data Type:	REAL	Access Type:	Read/Write

P 5.12.2.10 Brake Close Time

Set the time it takes for the mechanical brake to close and to hold the load.

Default Value:	0.5	Parameter Type:	Range (0.1 — 30)
Parameter Number:	3004	Unit:	s
Data Type:	REAL	Access Type:	Read/Write

Defines the delay from the electrical closing of the brake to when the brake physically closes. When closing, the load is transferred from the motor to the mechanical brake during the disengaging process. Enter the brake close time of the coast after ramp-down time. The shaft is held at 0 speed with full holding torque. Ensure that the mechanical brake has locked the load before the motor enters coast mode. To adjust the transition of the load to the mechanical brake, set parameters **5.12.2.10 Brake Close Time** and **5.12.2.8 Brake Hover Time**. Setting the brake delay parameters does not affect the torque. The drive does not register that the mechanical brake is holding the load. After setting parameter **5.12.2.10 Brake Close Time**, the torque drops to 0 after a few minutes. The sudden torque change causes movement and noise.

P 5.12.2.11 Brake Closed Input

Select the input terminal for a closed signal from the mechanical brake.

Default Value:	–	Parameter Type:	Selection
Parameter Number:	3011	Unit:	–
Data Type:	UINT	Access Type:	Read/Write

P 5.12.2.12 Brake Disengaging Time

Set the duration from the brake is closed to the holding torque is released.

Default Value:	0.2	Parameter Type:	Range (0 — 5)
Parameter Number:	3005	Unit:	s

Data Type:	REAL	Access Type:	Read/Write
-------------------	------	---------------------	------------

The value of this parameter defines the torque ramp down time to gradually transition the load from the motor to the brake. After the mechanical brake is closed, the motor still provides a holding torque. During the disengage, the holding torque is ramped to zero, gradually transferring the load to the mechanical brake.

P 5.12.2.13 Brake Release Bandwidth

Set the release control bandwidth.

Default Value:	100	Parameter Type:	Range (0 — 10000)
Parameter Number:	3015	Unit:	%
Data Type:	REAL	Access Type:	Read/Write

P 5.12.2.15 Brake Close Immediately On Fault

Enables immediate brake closure in case of a fault. Some faults will ramp to zero - if not set brake will wait for speed to be low enough.

Default Value:	1 (Enabled)	Parameter Type:	Selection
Parameter Number:	3040	Unit:	–
Data Type:	BOOL	Access Type:	Read/Write

The following are the selections for the parameter.

Selection Number	Selection Name	Selection Description
0	Disabled	Disables the function.
1	Enabled	Enables the function.

P 5.12.2.20 Brake Feedback Error Time

Set the monitoring time for the brake feedback error. The error is triggered if brake open or close feedback(s) differ from the command signal for the set time. The monitoring is started when the brake open or close command is sent or the feedback signal(s) change status.

Default Value:	–	Parameter Type:	Range (0 — 30)
Parameter Number:	3043	Unit:	s
Data Type:	REAL	Access Type:	Read/Write

P 5.12.2.21 Brake Slip Detection Response

Select the response to a detected brake slip.

Default Value:	1 (Warning)	Parameter Type:	Selection
Parameter Number:	3031	Unit:	–
Data Type:	UINT	Access Type:	Read/Write

The following are the selections for the parameter.

Selection Number	Selection Name	Selection Description
0	Off	The feature is disabled.
1	Warning	The drive issues a warning.
2	Catch Mode	Catch Mode holds the load in place when a brake slip error is detected.

P 5.12.2.22 Brake Slip Limit

Set the angle for maximum allowed brake slip.

Default Value:	60	Parameter Type:	Range (0 — 3600)
Parameter Number:	3030	Unit:	°
Data Type:	REAL	Access Type:	Read/Write

6.6.14 Additional Status Outputs (Menu Index 5.26)

6.6.14.1 General Digital Outputs (Menu Index 5.26.1)

P 5.26.1.1 Ready Output

Select an output to indicate that the unit is in ready mode.

Default Value:	–	Parameter Type:	Selection
Parameter Number:	205	Unit:	–
Data Type:	UINT	Access Type:	Read/Write

P 5.26.1.2 Run Output

Select an output to indicate that the unit is in run mode.

Default Value:	–	Parameter Type:	Selection
Parameter Number:	206	Unit:	–
Data Type:	UINT	Access Type:	Read/Write

P 5.26.1.3 On Reference Output

Select an output to indicate that the unit is on reference.

Default Value:	–	Parameter Type:	Selection
Parameter Number:	207	Unit:	–
Data Type:	UINT	Access Type:	Read/Write

P 5.26.1.4 Fault Event Output

Select an output to indicate that a fault has occurred.

Default Value:	–	Parameter Type:	Selection
Parameter Number:	208	Unit:	–
Data Type:	UINT	Access Type:	Read/Write

P 5.26.1.5 Warning Event Output

Select an output to indicate that a warning has occurred.

Default Value:	–	Parameter Type:	Selection
Parameter Number:	209	Unit:	–
Data Type:	UINT	Access Type:	Read/Write

P 5.26.1.26 Motor Disconnected Output

Select an output to indicate that the motor is disconnected. Motor check must be enabled in disconnected motor response.

Default Value:	–	Parameter Type:	Selection
Parameter Number:	216	Unit:	–
Data Type:	UINT	Access Type:	Read/Write

6.6.15 Fieldbus Process Data (Menu Index 5.27)

6.6.15.1 Fieldbus Process Data Status (Menu Index 5.27.1)

P 5.27.1.42 Fieldbus Control Word

Shows the profile specific fieldbus control word.

Default Value:	NA	Parameter Type:	Range (* — *)
Parameter Number:	1335	Unit:	–
Data Type:	WORD	Access Type:	Read/Write

The fieldbus control word is either the PROFIdrive control word described in [2.12.2 Control Word](#) or the iC Speed control word described in [2.13.2 Control Word](#). The fieldbus profile is selected with parameter [10.3.1.2 Fieldbus Profile](#).

P 5.27.1.43 Fieldbus Speed Reference 1

Shows the fieldbus speed reference.

Default Value:	NA	Parameter Type:	Range (-32768 — 32767)
Parameter Number:	1339	Unit:	–
Data Type:	INT	Access Type:	Read/Write

P 5.27.1.44 Fieldbus Torque Reference

Shows the fieldbus torque reference.

Default Value:	NA	Parameter Type:	Range (-49152.00 — 49152.00)
Parameter Number:	1343	Unit:	N2MotorNomTorque
Data Type:	INT	Access Type:	Read/Write

P 5.27.1.50 Fieldbus Status Word

Shows the profile specific fieldbus status word.

Default Value:	NA	Parameter Type:	Range (* — *)
Parameter Number:	1307	Unit:	–
Data Type:	WORD	Access Type:	Read Only

The fieldbus status word is either the PROFIdrive status word described in [2.12.3 Status Word \(STW\) in PROFIdrive Standard Telegram 1](#) or the iC Speed status word described in [2.13.3 Status Word \(STW\) in iC Speed Profile](#). The fieldbus profile is selected with parameter [10.3.1.2 Fieldbus Profile](#).

P 5.27.1.51 Actual Motor Speed

Shows the actual motor speed.

Default Value:	NA	Parameter Type:	Range (-32768 — 32767)
Parameter Number:	1308	Unit:	–
Data Type:	INT	Access Type:	Read Only

P 5.27.1.54 Fieldbus Speed Reference

Shows the fieldbus speed reference.

Default Value:	NA	Parameter Type:	Range (-1000 — 1000)
Parameter Number:	1345	Unit:	Hz
Data Type:	REAL	Access Type:	Read/Write

P 5.27.1.73 Fieldbus Torque Main Actual Value

Shows the torque applied by the motor.

Default Value:	NA	Parameter Type:	Range (-32768 — 32767)
Parameter Number:	1346	Unit:	–
Data Type:	INT	Access Type:	Read Only

P 5.27.1.89 Fieldbus Control Word 2

Shows the fieldbus control word 2.

Default Value:	NA	Parameter Type:	Range (* — *)
Parameter Number:	1347	Unit:	–
Data Type:	WORD	Access Type:	Read/Write

The fieldbus control and status words are freely configurable, and specific features can be assigned to the bits.

P 5.27.1.90 Fieldbus Status Word 2

Shows the profile specific fieldbus status word 2.

Default Value:	NA	Parameter Type:	Range (* — *)
Parameter Number:	1344	Unit:	–
Data Type:	WORD	Access Type:	Read Only

The fieldbus control and status words are freely configurable, and specific features can be assigned to the bits.

P 5.27.1.100 Fieldbus Process Reference

Shows the fieldbus process reference used in the process controller.

Default Value:	NA	Parameter Type:	Range (-32768 — 32767)
Parameter Number:	6046	Unit:	–
Data Type:	INT	Access Type:	Read/Write

6.6.16 Auxiliary Device Control (Menu Index 5.33)

P 5.33.1 Motor and Cabinet Heater Ctrl. Output

Select an output to control the motor and cabinet heaters.

Default Value:	–	Parameter Type:	Selection
Parameter Number:	220	Unit:	–
Data Type:	UINT	Access Type:	Read/Write

P 5.33.2 Motor Fan Ctrl. Output

Select an output to control the motor fan.

Default Value:	–	Parameter Type:	Selection
Parameter Number:	221	Unit:	–
Data Type:	UINT	Access Type:	Read/Write

P 5.33.3 Cabinet Cooling Fan Ctrl. Output

Select an output to control the cabinet cooling fan.

Default Value:	–	Parameter Type:	Selection
Parameter Number:	222	Unit:	–
Data Type:	UINT	Access Type:	Read/Write

6.7 Maintenance & Service (Menu Index 6)

6.7.1 Maintenance & Service Overview

This parameter group contains parameters exclusively related to status, events, and backup and restore.

6.7.2 Status (Menu Index 6.1)

6.7.2.1 Grid Status (Menu Index 1.1)

P 1.1.1 Grid Frequency

Shows the actual grid frequency.

Default Value:	NA	Parameter Type:	Range (* — *)
Parameter Number:	9041	Unit:	Hz
Data Type:	REAL	Access Type:	Read Only

P 1.1.2 Line-To-Line Voltage (RMS)

Shows the average line-to-line voltage (RMS).

Default Value:	NA	Parameter Type:	Range (0 — *)
Parameter Number:	9040	Unit:	V
Data Type:	REAL	Access Type:	Read Only

P 1.1.3 L1-L2 Line Voltage (RMS)

Shows the L1-L2 line voltage (RMS).

Default Value:	NA	Parameter Type:	Range (0 — *)
Parameter Number:	9048	Unit:	V
Data Type:	REAL	Access Type:	Read Only

P 1.1.4 L2-L3 Line Voltage (RMS)

Shows the L2-L3 line voltage (RMS).

Default Value:	NA	Parameter Type:	Range (0 — *)
Parameter Number:	9049	Unit:	V
Data Type:	REAL	Access Type:	Read Only

P 1.1.5 L3-L1 Line Voltage (RMS)

Shows the L3-L1 line voltage (RMS).

Default Value:	NA	Parameter Type:	Range (0 — *)
Parameter Number:	9050	Unit:	V
Data Type:	REAL	Access Type:	Read Only

P 1.1.6 Grid Voltage Imbalance

Shows the grid voltage imbalance in %. A value greater than 3% may indicate grid problems.

Default Value:	NA	Parameter Type:	Range (0 — 100)
Parameter Number:	9047	Unit:	%
Data Type:	REAL	Access Type:	Read Only

P 1.1.7 Total Harmonic Distortion (THDv)

Shows the total harmonic distortion of the grid voltage (THDv) in %.

Default Value:	NA	Parameter Type:	Range (0 — 100)
Parameter Number:	9046	Unit:	%
Data Type:	REAL	Access Type:	Read Only

P 1.1.8 Grid Current

Shows the current at the point of common coupling.

Default Value:	NA	Parameter Type:	Range (0 — *)
Parameter Number:	9060	Unit:	A
Data Type:	REAL	Access Type:	Read Only

P 1.1.9 Grid Current %

Shows the current at the point of common coupling in % of grid nominal current. The grid nominal current is defined in Grid Settings.

Default Value:	NA	Parameter Type:	Range (-1000 — 1000)
Parameter Number:	9061	Unit:	%
Data Type:	REAL	Access Type:	Read Only

P 1.1.10 Grid Active Current %

Shows the active current in % of grid nominal current.

Default Value:	NA	Parameter Type:	Range (-1000 — 1000)
Parameter Number:	9062	Unit:	%
Data Type:	REAL	Access Type:	Read Only

P 1.1.11 Grid Reactive Current %

Shows the reactive current in % of grid nominal current.

Default Value:	NA	Parameter Type:	Range (-300 — 300)
Parameter Number:	9063	Unit:	%
Data Type:	REAL	Access Type:	Read Only

P 1.1.12 Grid Active Power

Shows the active power at the point of grid connection.

Default Value:	NA	Parameter Type:	Range (* — *)
Parameter Number:	9064	Unit:	kW
Data Type:	REAL	Access Type:	Read Only

P 1.1.13 Grid Active Power %

Shows the grid active power in % of grid nominal power.

Default Value:	NA	Parameter Type:	Range (-1000 — 1000)
Parameter Number:	9065	Unit:	%
Data Type:	REAL	Access Type:	Read Only

P 1.1.14 Grid Reactive Power

Shows the grid reactive power.

Default Value:	NA	Parameter Type:	Range (* — *)
Parameter Number:	9051	Unit:	kVA
Data Type:	REAL	Access Type:	Read Only

P 1.1.15 Grid Reactive Power %

Shows the grid reactive power in % of grid nominal power.

Default Value:	NA	Parameter Type:	Range (-1000 — 1000)
Parameter Number:	9052	Unit:	%
Data Type:	REAL	Access Type:	Read Only

P 1.1.16 Grid Power Factor

Shows the grid power factor.

Default Value:	NA	Parameter Type:	Range (-1 — 1)
Parameter Number:	9053	Unit:	–
Data Type:	REAL	Access Type:	Read Only

6.7.2.2 Power Conversion & DC Link Status (Menu Index 2.1)

P 2.1.1 Unit Nominal Voltage

Shows the nominal voltage setting as a result of the setting of parameter "2.2.1.1 Unit Voltage Class".

Default Value:	400	Parameter Type:	Range (0 — *)
Parameter Number:	2830	Unit:	V
Data Type:	REAL	Access Type:	Read Only

P 2.1.2 Unit Nominal Current

Shows the nominal current of the unit.

Default Value:	23	Parameter Type:	Range (0 — *)
Parameter Number:	2831	Unit:	A
Data Type:	REAL	Access Type:	Read Only

P 2.1.3 DC-link Voltage

Shows the actual DC-link voltage.

Default Value:	NA	Parameter Type:	Range (0 — *)
Parameter Number:	9044	Unit:	V
Data Type:	REAL	Access Type:	Read Only

P 2.1.7 DC-link Power

Shows the actual DC-link power.

Default Value:	NA	Parameter Type:	Range (* — *)
Parameter Number:	5117	Unit:	kW
Data Type:	REAL	Access Type:	Read Only

P 2.1.10 U-phase RMS Current

Shows the U-phase RMS current.

Default Value:	NA	Parameter Type:	Range (0 — *)
Parameter Number:	9020	Unit:	A
Data Type:	REAL	Access Type:	Read Only

P 2.1.11 V-phase RMS Current

Shows the V-phase RMS current.

Default Value:	NA	Parameter Type:	Range (0 — *)
Parameter Number:	9021	Unit:	A
Data Type:	REAL	Access Type:	Read Only

P 2.1.12 W-phase RMS Current

Shows the W-phase RMS current.

Default Value:	NA	Parameter Type:	Range (0 — *)
----------------	----	-----------------	----------------

Parameter Number:	9022	Unit:	A
Data Type:	REAL	Access Type:	Read Only

P 2.1.14 Actual Relative Output Current Limit

Shows the actual output current limit relative to the nominal motor current.

Default Value:	NA	Parameter Type:	Range (0 — 300)
Parameter Number:	2700	Unit:	%
Data Type:	REAL	Access Type:	Read Only

P 2.1.15 Heat Sink Temperature

Shows the temperature of the power unit heat sink.

Default Value:	NA	Parameter Type:	Range (-50 — 200)
Parameter Number:	2950	Unit:	°C
Data Type:	REAL	Access Type:	Read Only

P 2.1.16 Main Fan Speed

Shows the speed of the main cooling fan.

Default Value:	NA	Parameter Type:	Range (0 — 32767)
Parameter Number:	2931	Unit:	rpm
Data Type:	INT	Access Type:	Read Only

P 2.1.17 Internal Fan Speed

Shows the speed of the internal cooling fan.

Default Value:	NA	Parameter Type:	Range (0 — 32767)
Parameter Number:	2926	Unit:	rpm
Data Type:	INT	Access Type:	Read Only

P 2.1.19 Heat Sink Temperature Output

Select the output indicating if the heat sink temperature is within the specified range.

Default Value:	–	Parameter Type:	Selection
Parameter Number:	2312	Unit:	–
Data Type:	UINT	Access Type:	Read/Write

P 2.1.20 Drive DC-link Voltage Output

Select the output indicating if the DC-link voltage is within the specified range.

Default Value:	–	Parameter Type:	Selection
Parameter Number:	2311	Unit:	–
Data Type:	UINT	Access Type:	Read/Write

6.7.2.3 Filters & Brake Chopper Status (Menu Index 3.1)

P 3.1.1 Brake Power

Shows the power dissipated in the brake resistor.

Default Value:	NA	Parameter Type:	Range (0.00 — *)
Parameter Number:	2933	Unit:	kW
Data Type:	REAL	Access Type:	Read Only

P 3.1.2 Average Brake Power

Shows the average power dissipated in the brake resistor, calculated over 120 s.

Default Value:	NA	Parameter Type:	Range (0.00 — *)
Parameter Number:	2934	Unit:	kW
Data Type:	REAL	Access Type:	Read Only

P 3.1.3 AHF Capacitor Connected

Shows if the advanced harmonic filter (AHF) capacitor is connected.

Default Value:	NA	Parameter Type:	Range (False — True)
Parameter Number:	5410	Unit:	–
Data Type:	BOOL	Access Type:	Read Only

6.7.2.4 Motor Status (Menu Index 4.1)

P 4.1.1 Motor Current

Shows the actual motor current.

Default Value:	NA	Parameter Type:	Range (0 — *)
Parameter Number:	9000	Unit:	A
Data Type:	REAL	Access Type:	Read Only

P 4.1.2 Relative Motor Current

Shows the actual motor current in % of the nominal motor current.

Default Value:	NA	Parameter Type:	Range (0 — 200)
Parameter Number:	9001	Unit:	%
Data Type:	REAL	Access Type:	Read Only

P 4.1.3 U-phase RMS Current

Shows the U-phase RMS current.

Default Value:	NA	Parameter Type:	Range (0 — *)
Parameter Number:	9020	Unit:	A
Data Type:	REAL	Access Type:	Read Only

P 4.1.4 V-phase RMS Current

Shows the V-phase RMS current.

Default Value:	NA	Parameter Type:	Range (0 — *)
Parameter Number:	9021	Unit:	A

Data Type:	REAL	Access Type:	Read Only
-------------------	------	---------------------	-----------

P 4.1.5 W-phase RMS Current

Shows the W-phase RMS current.

Default Value:	NA	Parameter Type:	Range (0 — *)
Parameter Number:	9022	Unit:	A
Data Type:	REAL	Access Type:	Read Only

P 4.1.6 Motor Voltage

Shows the actual motor voltage.

Default Value:	NA	Parameter Type:	Range (0 — *)
Parameter Number:	9005	Unit:	V
Data Type:	REAL	Access Type:	Read Only

P 4.1.7 Relative Motor Voltage

Shows the actual motor voltage in % of the nominal motor voltage.

Default Value:	NA	Parameter Type:	Range (0 — 200)
Parameter Number:	9006	Unit:	%
Data Type:	REAL	Access Type:	Read Only

P 4.1.11 Motor Torque

Shows the actual motor torque.

Default Value:	NA	Parameter Type:	Range (-10000000 — 10000000)
Parameter Number:	9009	Unit:	Nm
Data Type:	REAL	Access Type:	Read Only

P 4.1.12 Relative Motor Torque

Shows the motor torque in % of the nominal motor torque.

Default Value:	NA	Parameter Type:	Range (* — *)
Parameter Number:	1708	Unit:	%
Data Type:	REAL	Access Type:	Read Only

P 4.1.13 Motor Shaft Power

Shows the actual power at the motor shaft.

Default Value:	NA	Parameter Type:	Range (* — *)
Parameter Number:	9008	Unit:	kW
Data Type:	REAL	Access Type:	Read Only

P 4.1.14 Relative Motor Shaft Power

Shows the actual motor shaft power in % of the nominal motor shaft power.

Default Value:	NA	Parameter Type:	Range (-300 — 300)
Parameter Number:	1707	Unit:	%
Data Type:	REAL	Access Type:	Read Only

P 4.1.15 Motor Electrical Power

Shows the actual motor power.

Default Value:	NA	Parameter Type:	Range (* — *)
Parameter Number:	9043	Unit:	kW
Data Type:	REAL	Access Type:	Read Only

P 4.1.16 Motor Thermal Load (ETR)

Shows the estimated thermal load of the motor calculated by the ETR function.

Default Value:	NA	Parameter Type:	Range (0 — 100)
Parameter Number:	2951	Unit:	%
Data Type:	REAL	Access Type:	Read Only

P 4.1.17 Motor Current Output

Select an output for the motor current signal. The scale of the signal is 0–100% of the nominal current.

Default Value:	–	Parameter Type:	Selection
Parameter Number:	2302	Unit:	–
Data Type:	UINT	Access Type:	Read/Write

P 4.1.18 Motor Voltage Output

Select an output for the motor voltage signal. The scale of the signal is 0–100% of the nominal voltage.

Default Value:	–	Parameter Type:	Selection
Parameter Number:	2303	Unit:	–
Data Type:	UINT	Access Type:	Read/Write

P 4.1.19 Absolute Motor Torque Output

Select an output for the motor torque signal. The scale of the signal is 0–100% of the absolute value of the nominal torque.

Default Value:	–	Parameter Type:	Selection
Parameter Number:	2306	Unit:	–
Data Type:	UINT	Access Type:	Read/Write

P 4.1.20 Extended Motor Torque Output

Select an output for the motor torque signal. The scale of the signal is -200...200% of the nominal torque.

Default Value:	–	Parameter Type:	Selection
Parameter Number:	2310	Unit:	–
Data Type:	UINT	Access Type:	Read/Write

P 4.1.21 Absolute Motor Speed Output

Select an output for the motor speed signal. The scale of the signal is 0–100% of the absolute value of the nominal speed.

Default Value:	–	Parameter Type:	Selection
Parameter Number:	2301	Unit:	–
Data Type:	UINT	Access Type:	Read/Write

P 4.1.22 Extended Motor Speed Output

Select an output for the motor speed signal. The scale of the signal is -200...200% of the nominal speed.

Default Value:	–	Parameter Type:	Selection
Parameter Number:	2309	Unit:	–
Data Type:	UINT	Access Type:	Read/Write

P 4.1.23 Motor Power Output

Select an output for the motor power signal. The scale of the signal is 0–100% of the nominal power.

Default Value:	–	Parameter Type:	Selection
Parameter Number:	2305	Unit:	–
Data Type:	UINT	Access Type:	Read/Write

P 4.1.24 AMA Progress

Shows the progress of the Automatic Motor Adaptation (AMA).

Default Value:	NA	Parameter Type:	Range (0 — 100)
Parameter Number:	429	Unit:	%
Data Type:	REAL	Access Type:	Read Only

P 4.1.26 Motor Temperature

The analog temperature sensor has exceeded the configured value.

Default Value:	NA	Parameter Type:	Range (-300 — 300)
Parameter Number:	1630	Unit:	°C
Data Type:	REAL	Access Type:	Read Only

P 4.1.28 Rs Measured

When a Rs measurement is stored for use after drive power recycle, the value is shown here; otherwise it is zero.

Default Value:	NA	Parameter Type:	Range (0 — 100000)
Parameter Number:	433	Unit:	Ω
Data Type:	REAL	Access Type:	Read Only

6.7.2.5 Application Status (Menu Index 5.1)

P 5.1.1 Motor Ctrl. Status Word

Shows the motor control status word.

Default Value:	NA	Parameter Type:	Range (* — *)
Parameter Number:	1714	Unit:	–

Data Type: WORD Access Type: Read Only

Table 44: Motor Ctrl. Status Word bit descriptions

Bit	Description
0	Ready
1	Run
2	Reverse
3	Fault
4	Reserved
5	At reference
6	Zero speed
7	Protection mode active

P 5.1.2 Motor Ctrl. Ready Status Word

Shows the motor control ready status word. All status bits must be true before the drive is ready.

Default Value: NA Parameter Type: Range (* — *)
 Parameter Number: 1716 Unit: –
 Data Type: WORD Access Type: Read Only

Table 45: Motor Ctrl. Ready Status Word bit descriptions

Bit	Description
0	Run Enable high.
1	No fault active.
2	DC-link pre-charging done.
3	DC Voltage within limits.
4	Power manager initialized.
5	Brake test not running.
6	System software is not blocking start.
7	Grid voltage within limits.
8	Temperature within limits.
9	Valid motor data.
10	Valid control configuration.

P 5.1.3 Motor Regulator Status Word

Shows the current state of the motor regulator status word. The status word indicates if a limit controller is active.

Default Value: NA Parameter Type: Range (* — *)
 Parameter Number: 1715 Unit: –
 Data Type: WORD Access Type: Read Only

Table 46: Motor Regulator Status Word bit descriptions

Bit	Description
0	Current limit control active (motoring side).
1	Current limit control active (generator side).
2	Torque limit control active (motoring side).
3	Torque limit control active (generator side).
4	Overvoltage control active.
5	Undervoltage control active.
6	Power limit control active (motoring side).
7	Power limit control active (generator side).
8	Speed limit control active.
9	AC-brake control active.

P 5.1.5 Fault Status Word 1

Shows the fault status word 1.

Default Value:	–	Parameter Type:	Range (* — *)
Parameter Number:	6203	Unit:	–
Data Type:	DWORD	Access Type:	–

Table 47: Fault Status Word 1 bit descriptions

Bit	Description	Event number
0	Overcurrent	4384, 4373, 5170, 4368, 4369, 4375, 4377, 4380, 4097
1	Overvoltage	4164, 4162, 4144 4145
2	Undervoltage	4165, 4146
3	Unit temperature high	4117, 4118, 4119
4	Unit temperature low	4116
5	Control board overtemperature	4121, 4122, 4123, 4120
6	Input phase	4160, 4163
7	Output phase	4175, 4176
8	Ground fault	4379, 4352, 4353, 4354, 4355
9	Fan failure	4128, 4129, 4133, 4130
10	Fieldbus communication	5162, 4256, 4257, 4258, 4260, 4261, 4263, 4265, 4266, 4267, 4268, 4269, 4280, 4281, 4270, 4271, 4272, 4273, 4282, 4274, 4275, 4276, 4277, 4283, 4278, 4279
11	HMI connection	5141, 5142
12	Feedback connection	4418
13	Thermistor input	5157
14	Auxiliary device (temperature)	4200, 4201, 4203, 4202
15	External temperature measurement	5132, 5133, 5134, 5135, 5136, 5137, 5158

P 5.1.8 Warning Status Word 1

Shows the warning status word 1.

Default Value:	–	Parameter Type:	Range (* — *)
Parameter Number:	6205	Unit:	–
Data Type:	DWORD	Access Type:	–

Table 48: Warning Status Word 1 bit descriptions

Bit	Description	Event number
0	Overcurrent	4384, 4373, 5170, 4368, 4369, 4375, 4377, 4380, 4097
1	Overvoltage	4164, 4162, 4144 4145
2	Undervoltage	4165, 4146
3	Unit temperature high	4117, 4118, 4119
4	Unit temperature low	4116
5	Control board overtemperature	4121, 4122, 4123, 4120
6	Input phase	4160, 4163
7	Output phase	4175, 4176
8	Ground fault	4379, 4352, 4353, 4354, 4355
9	Fan failure	4128, 4129, 4133, 4130
10	Fieldbus communication	5162, 4256, 4257, 4258, 4260, 4261, 4263, 4265, 4266, 4267, 4268, 4269, 4280, 4281, 4270, 4271, 4272, 4273, 4282, 4274, 4275, 4276, 4277, 4283, 4278, 4279
11	HMI connection	5141, 5142
12	Feedback connection	4418
13	Thermistor input	5157
14	Auxiliary device (temperature)	4200, 4201, 4203, 4202
15	External temperature measurement	5132, 5133, 5134, 5135, 5136, 5137, 5158

P 5.1.13 Application Status Word

Shows the application-specific status word.

Default Value:	NA	Parameter Type:	Range (* — *)
Parameter Number:	1608	Unit:	–
Data Type:	WORD	Access Type:	Read Only

Table 49: Application Status Word bit descriptions

Bit	Bit = False	Bit = True
0	Local Control	Remote Control
1	Inching not Active	Inching Active
2	Process Control not Active	Process Control Active
3	-	Start Interlock

Table 49: Application Status Word bit descriptions (continued)

Bit	Bit = False	Bit = True
4	STO Not Active	STO Active
5	No Warning	Warning Active
6	No Fault	Fault Active
7	Reserved	Reserved
8	Reserved	Reserved
9	Reserved	Reserved
10	Reserved	Reserved
11	Reserved	Reserved
12	Reserved	Reserved
13	Normal Reference	Freeze Reference
14	Normal Reference	Reverse Reference
15	Speed Within Limits	Speed Limit Active

6.7.2.6 Measured Temp. Protection Status (Menu Index 5.2.3.1)

P 5.2.3.1.1 Protection 1 Temp.

Shows the temperature measured for the temperature protection.

Default Value:	NA	Parameter Type:	Range (-300 — 300)
Parameter Number:	5200	Unit:	°C
Data Type:	REAL	Access Type:	Read Only

P 5.2.3.1.2 Protection 2 Temp.

Shows the temperature measured for the temperature protection.

Default Value:	NA	Parameter Type:	Range (-300 — 300)
Parameter Number:	5201	Unit:	°C
Data Type:	REAL	Access Type:	Read Only

P 5.2.3.1.3 Protection 3 Temp.

Shows the temperature measured for the temperature protection.

Default Value:	NA	Parameter Type:	Range (-300 — 300)
Parameter Number:	5202	Unit:	°C
Data Type:	REAL	Access Type:	Read Only

P 5.2.3.1.4 Protection 4 Temp.

Shows the temperature measured for the temperature protection.

Default Value:	NA	Parameter Type:	Range (-300 — 300)
Parameter Number:	5203	Unit:	°C
Data Type:	REAL	Access Type:	Read Only

P 5.2.3.1.5 Protection 5 Temp.

Shows the temperature measured for the temperature protection.

Default Value:	NA	Parameter Type:	Range (-300 — 300)
Parameter Number:	5204	Unit:	°C
Data Type:	REAL	Access Type:	Read Only

P 5.2.3.1.6 Protection 6 Temp.

Shows the temperature measured for the temperature protection.

Default Value:	NA	Parameter Type:	Range (-300 — 300)
Parameter Number:	5205	Unit:	°C
Data Type:	REAL	Access Type:	Read Only

6.7.2.7 Load Status (Menu Index 5.3.1)

P 5.3.1.1 Inertia Estimation Status

Shows the status of the inertia estimation routine. 0 = Inactive, 1 = In progress, 2 = Completed successfully, 3 = Completed unsuccessfully.

Default Value:	NA	Parameter Type:	Selection
Parameter Number:	666	Unit:	–
Data Type:	UINT	Access Type:	Read Only

The following are the selections for the parameter.

Selection Number	Selection Name	Selection Description
0	Inactive	
1	In progress	
2	Completed successfully	
3	Completed unsuccessfully	

6.7.2.8 Control Places Status (Menu Index 5.5.1)

P 5.5.1.1 Active Control Place

Shows the control place that controls the drive.

Default Value:	NA	Parameter Type:	Selection
Parameter Number:	113	Unit:	–
Data Type:	UINT	Access Type:	Read Only

The following are the selections for the parameter.

Selection Number	Selection Name	Selection Description
0	PC control	The drive is controlled by a software tool.
1	Local control	The drive is controlled by a connected control panel.

Selection Number	Selection Name	Selection Description
2	Fieldbus control	The drive is controlled via a fieldbus.
3	I/O control	The drive is controlled via I/O.
4	Advanced control	The drive is controlled via a combination of I/O and fieldbus.

P 5.5.1.2 Local Control Active Output

Select an output terminal indicating that the drive is in local control.

Default Value:	–	Parameter Type:	Selection
Parameter Number:	5178	Unit:	–
Data Type:	UINT	Access Type:	Read/Write

P 5.5.1.3 Fieldbus Control Active Output

Select an output terminal indicating that the drive is in fieldbus control.

Default Value:	–	Parameter Type:	Selection
Parameter Number:	5197	Unit:	–
Data Type:	UINT	Access Type:	Read/Write

P 5.5.1.4 I/O Control Active Output

Select an output terminal indicating that the drive is in I/O control.

Default Value:	–	Parameter Type:	Selection
Parameter Number:	5177	Unit:	–
Data Type:	UINT	Access Type:	Read/Write

P 5.5.1.5 Advanced Control Active Output

Select an output terminal indicating that the drive is in advanced control.

Default Value:	–	Parameter Type:	Selection
Parameter Number:	4727	Unit:	–
Data Type:	UINT	Access Type:	Read/Write

6.7.2.9 Speed Control Status (Menu Index 5.8.1)

P 5.8.1.2 Motor Speed

Shows the actual motor speed.

Default Value:	NA	Parameter Type:	Range (* — *)
Parameter Number:	9011	Unit:	Hz
Data Type:	REAL	Access Type:	Read Only

P 5.8.1.3 Output Frequency

Shows the output frequency.

Default Value:	NA	Parameter Type:	Range (* — *)
-----------------------	----	------------------------	-----------------

Parameter Number: 9015	Unit: Hz
Data Type: REAL	Access Type: Read Only

P 5.8.1.4 Feedback Speed

Shows the feedback speed.

Default Value: NA	Parameter Type: Range (-10000 — 10000)
Parameter Number: 9007	Unit: rpm
Data Type: REAL	Access Type: Read Only

P 5.8.1.5 Feedback Electrical Angle

Shows the feedback device angle in the electrical domain. Its value is needed for manually tuning the feedback angle offset.

Default Value: NA	Parameter Type: Range (0 — 360)
Parameter Number: 9016	Unit: °
Data Type: REAL	Access Type: Read Only

P 5.8.1.6 Speed Error

Shows the difference between speed reference after ramp and motor speed.

Default Value: NA	Parameter Type: Range (* — *)
Parameter Number: 4023	Unit: Hz
Data Type: REAL	Access Type: Read Only

P 5.8.1.7 Speed Reference

Shows the speed reference.

Default Value: NA	Parameter Type: Range (-2000 — 2000)
Parameter Number: 1718	Unit: Hz
Data Type: REAL	Access Type: Read/Write

P 5.8.1.8 Speed Reference Before Ramp

Shows the value of speed reference before the ramp generator.

Default Value: NA	Parameter Type: Range (-2000 — 2000)
Parameter Number: 6049	Unit: Hz
Data Type: REAL	Access Type: Read Only

P 5.8.1.9 Speed Reference After Ramp

Shows the value of the speed reference after the ramp generator.

Default Value: NA	Parameter Type: Range (* — *)
Parameter Number: 6150	Unit: Hz
Data Type: REAL	Access Type: Read Only

P 5.8.1.10 Final Speed Reference

Shows the value of the speed reference before feeding it to the speed controller.

Default Value:	NA	Parameter Type:	Range (* — *)
Parameter Number:	6151	Unit:	Hz
Data Type:	REAL	Access Type:	Read Only

P 5.8.1.11 Control Panel Speed Reference

Shows the value of the speed reference given from the control panel.

Default Value:	NA	Parameter Type:	Range (* — *)
Parameter Number:	6153	Unit:	Hz
Data Type:	REAL	Access Type:	Read/Write

P 5.8.1.12 Absolute Output Frequency Output

Select an output terminal for the output frequency scaled between 0 Hz and positive speed limits in Hz.

Default Value:	–	Parameter Type:	Selection
Parameter Number:	2300	Unit:	–
Data Type:	UINT	Access Type:	Read/Write



NOTE: Selection lists with inputs and/or outputs consist of the name of the hardware option and the numbers of the terminals. For example, terminal number 13 of the Basic I/O is called Basic I/O T13 in the selection list.

P 5.8.1.13 Absolute Speed Reference Output

Select an output terminal for the absolute speed reference, scaled between 0 and positive speed limit.

Default Value:	–	Parameter Type:	Selection
Parameter Number:	2304	Unit:	–
Data Type:	UINT	Access Type:	Read/Write



NOTE: Selection lists with inputs and/or outputs consist of the name of the hardware option and the numbers of the terminals. For example, terminal number 13 of the Basic I/O is called Basic I/O T13 in the selection list.

P 5.8.1.14 Output Frequency Output

Select an output terminal for the output frequency scaled between minimum speed limit and positive speed limits in Hz.

Default Value:	–	Parameter Type:	Selection
Parameter Number:	2308	Unit:	–
Data Type:	UINT	Access Type:	Read/Write



NOTE: Selection lists with inputs and/or outputs consist of the name of the hardware option and the numbers of the terminals. For example, terminal number 13 of the Basic I/O is called Basic I/O T13 in the selection list.

P 5.8.1.16 Load Drooping Speed

Shows the load drooping speed.

Default Value:	NA	Parameter Type:	Range (0 — 2000)
Parameter Number:	674	Unit:	Hz
Data Type:	REAL	Access Type:	Read Only

6.7.2.10 Torque Control Status (Menu Index 5.9.1)

P 5.9.1.1 Motor Torque

Shows the actual motor torque.

Default Value:	NA	Parameter Type:	Range (-10000000 — 10000000)
Parameter Number:	9009	Unit:	Nm
Data Type:	REAL	Access Type:	Read Only

P 5.9.1.2 Relative Motor Torque

Shows the motor torque in % of the nominal motor torque.

Default Value:	NA	Parameter Type:	Range (* — *)
Parameter Number:	1708	Unit:	%
Data Type:	REAL	Access Type:	Read Only

P 5.9.1.3 Torque Limit Motoring

Shows the torque limit in motoring mode in % of nominal motor torque.

Default Value:	NA	Parameter Type:	Range (0 — 500)
Parameter Number:	1812	Unit:	%
Data Type:	REAL	Access Type:	Read/Write

P 5.9.1.4 Torque Limit Regenerative

Shows the regenerative torque limit in % of nominal motor torque.

Default Value:	NA	Parameter Type:	Range (0 — 500)
Parameter Number:	1813	Unit:	%
Data Type:	REAL	Access Type:	Read/Write

P 5.9.1.5 Local Torque Reference

Shows the local torque reference set in the control panel.

Default Value:	NA	Parameter Type:	Range (-300 — 300)
Parameter Number:	6155	Unit:	%
Data Type:	REAL	Access Type:	Read/Write

P 5.9.1.6 Torque Reference

Shows the value of the current torque reference in the reference chain in % of nominal motor torque.

Default Value:	NA	Parameter Type:	Range (-300 — 300)
Parameter Number:	6152	Unit:	%
Data Type:	REAL	Access Type:	Read/Write

P 5.9.1.7 Torque Reference Final

Shows the value of the final torque reference given to the motor controller in % of nominal motor torque.

Default Value:	NA	Parameter Type:	Range (-300 — 300)
Parameter Number:	6154	Unit:	%
Data Type:	REAL	Access Type:	Read Only

6.7.2.11 Process Control Status (Menu Index 5.10.1)

P 5.10.1.1 On Reference

Shows if the controlled process is operating on the current reference.

Default Value:	NA	Parameter Type:	Range (False — True)
Parameter Number:	6074	Unit:	–
Data Type:	BOOL	Access Type:	Read Only

P 5.10.1.2 Process Controller Output

Shows the output of the process controller as normalized value (in the range 0 to 1).

Default Value:	NA	Parameter Type:	Range (-1000000 — 1000000)
Parameter Number:	6075	Unit:	–
Data Type:	REAL	Access Type:	Read Only

P 5.10.1.3 Setpoint Value

Shows the actual value of the setpoint.

Default Value:	NA	Parameter Type:	Range (-1000000 — 1000000)
Parameter Number:	6092	Unit:	–
Data Type:	REAL	Access Type:	Read Only

P 5.10.1.4 Feedback Value

Shows the actual value of the feedback.

Default Value:	NA	Parameter Type:	Range (* — *)
Parameter Number:	6090	Unit:	CustomProcessUnit
Data Type:	REAL	Access Type:	Read Only

P 5.10.1.5 Adv. Feedforward Value

Shows the actual value of the advanced feedforward.

Default Value:	NA	Parameter Type:	Range (-1000000 — 1000000)
Parameter Number:	6086	Unit:	–
Data Type:	REAL	Access Type:	Read Only

P 5.10.1.6 Feedback 1 Value

Shows the actual value of feedback 1.

Default Value:	NA	Parameter Type:	Range (-1000000 — 1000000)
-----------------------	----	------------------------	----------------------------

Parameter Number:	6080	Unit:	–
Data Type:	REAL	Access Type:	Read Only

P 5.10.1.7 Feedback 2 Value

Shows the actual value of feedback 2.

Default Value:	NA	Parameter Type:	Range (-1000000 — 1000000)
Parameter Number:	6085	Unit:	CustomProcessUnit
Data Type:	REAL	Access Type:	Read Only

P 5.10.1.9 Control Panel Process Reference

Shows the value of the process reference given from the control panel.

Default Value:	NA	Parameter Type:	Range (-1000000 — 1000000)
Parameter Number:	6094	Unit:	CustomProcessUnit
Data Type:	REAL	Access Type:	Read/Write

P 5.10.1.10 Process Controller Enabled

Enables the process controller.

Default Value:	NA	Parameter Type:	Range (False — True)
Parameter Number:	6053	Unit:	–
Data Type:	BOOL	Access Type:	Read Only

6.7.2.12 Mechanical Brake Control Status (Menu Index 5.12.1)

P 5.12.1.1 Mechanical Brake Status Word

Shows the mechanical brake status word.

Default Value:	NA	Parameter Type:	Range (* — *)
Parameter Number:	3016	Unit:	–
Data Type:	WORD	Access Type:	Read Only

Table 50: Status Word Description

Bit Number	Bit Name	Description
0	Enabled	The mechanical brake is enabled by a parameter.
1	Start	A start signal is provided to mechanical brake control.
2	Brake open feedback signal	Brake feedback is enabled and brake open is active.
3	Brake close feedback	Brake feedback is enabled and brake closed is active.
4–8	N/A	
9	Brake slip error	A higher slip than the defined limit has been detected in the mechanical brake.
10	Brake feedback state error	Both brake open and brake closed feedback signals are active at the same time.
11	Priming	The required release torque could not be generated.

Table 50: Status Word Description (continued)

Bit Number	Bit Name	Description
12	Brake release timeout	Feedback is enabled but the brake open feedback signal was not provided during brake release time.
13	Brake close timeout	Feedback is enabled but the brake closed feedback signal was not provided during brake close time.
14	BrakeCtrl active	Brake control is either opening or closing the brake.
15	Brake open	Brake control has activated the digital output.

P 5.12.1.2 Mechanical Brake State

Shows the state of the mechanical brake controller.

Default Value:	NA	Parameter Type:	Range (0 — 32767)
Parameter Number:	3017	Unit:	–
Data Type:	INT	Access Type:	Read Only

P 5.12.1.3 Brake Release Time Detected

Shows the time from brake release until load change is detected, where motor takes over the load from mechanical brake.

Default Value:	NA	Parameter Type:	Range (0 — 10000)
Parameter Number:	3041	Unit:	s
Data Type:	REAL	Access Type:	Read Only

6.7.2.13 Maintenance & Service (Menu Index 6.1.1)

P 6.1.1.1 Last Fault Number

Shows the number of the most recent active fault.

Default Value:	NA	Parameter Type:	Range (0 — 65535)
Parameter Number:	1610	Unit:	–
Data Type:	UINT	Access Type:	Read Only

P 6.1.1.2 Last Warning Number

Shows the number of the most recent active warning.

Default Value:	NA	Parameter Type:	Range (0 — 65535)
Parameter Number:	1609	Unit:	–
Data Type:	UINT	Access Type:	Read Only

P 6.1.1.3 Control Unit Temperature

Shows the temperature of the control unit.

Default Value:	NA	Parameter Type:	Range (-50 — 200)
Parameter Number:	2952	Unit:	°C
Data Type:	REAL	Access Type:	Read Only

6.7.3 Software Information (Menu Index 6.2)

P 6.2.1 Application Version

Shows the version of the application software.

Default Value:	–	Parameter Type:	Range (* — *)
Parameter Number:	151	Unit:	–
Data Type:	STRING	Access Type:	–

6.7.4 Events (Menu Index 6.4)

6.7.4.1 Event Simulation (Menu Index 6.4.3)

P 6.4.3.1 Simulate Event

Select a response to trigger a simulated event.

Default Value:	0 (No Action)	Parameter Type:	Selection
Parameter Number:	1400	Unit:	–
Data Type:	UINT	Access Type:	Read/Write

The following are the selections for the parameter.

Selection Number	Selection Name	Selection Description
0	No Action	No event is triggered.
1	Response 1	Activate event response 1.
2	Response 2	Activate event response 2.
3	Response 3	Activate event response 3.
4	Response 4	Activate event response 4.
5	Response 5	Activate event response 5.
6	Response 6	Activate event response 6.
7	Response 7	Activate event response 7.
8	Response 8	Activate event response 8.
9	Response 9	Activate event response 9.
10	Response 10	Activate event response 10.

P 6.4.3.2 Simulate Persisting Event

Select a response to trigger a persisting simulated event. Set back to 0 to allow a reset.

Default Value:	0 (No Action)	Parameter Type:	Selection
Parameter Number:	1401	Unit:	–
Data Type:	UINT	Access Type:	Read/Write

The following are the selections for the parameter.

Selection Number	Selection Name	Selection Description
0	No Action	No event is triggered.
1	Response 1	Activate event response 1.
2	Response 2	Activate event response 2.
3	Response 3	Activate event response 3.
4	Response 4	Activate event response 4.
5	Response 5	Activate event response 5.
6	Response 6	Activate event response 6.
7	Response 7	Activate event response 7.
8	Response 8	Activate event response 8.
9	Response 9	Activate event response 9.
10	Response 10	Activate event response 10.

P 6.4.3.3 Simulate Event Number

Set the number of the event to be simulated.

Default Value:	5260	Parameter Type:	Range (0 — 65535)
Parameter Number:	1402	Unit:	–
Data Type:	UINT	Access Type:	Read/Write

6.7.4.2 Auto Reset (Menu Index 6.4.4)

The automatic reset function enables the resetting of events without the need for a manual reset operation. This function is enabled with parameter **6.4.4.1 Auto Reset**.

When the function is enabled, a timer starts when an event requiring a reset is first triggered. An automatic reset is attempted at the end of each time interval. If any event requiring a reset is still active, the automatic reset attempt does not succeed, and the timer continues running. Once the maximum number of automatic reset attempts is reached, the automatic reset function stops, and a manual reset is required to clear the events.

If all events are reset (through either an automatic or manual reset), the function resets the number of attempts and stops the timer. The next event to trigger will begin a new cycle.

NOTICE

Before activating any automatic fault reset functions or changing limit values, make sure that no dangerous situations can occur after restart. If the auto reset function is activated, the device connected to the drive output starts automatically after an automatic fault reset.

NOTICE

A small set of events cannot be reset by the auto reset functionality, either because of safety reasons or because the events are critical for the lifetime of the drive.

P 6.4.4.1 Auto Reset

Enables the automatic resetting of events.

Default Value:	False	Parameter Type:	Selection
Parameter Number:	1405	Unit:	–
Data Type:	BOOL	Access Type:	Read/Write

The following are the selections for the parameter.

Selection Number	Selection Name	Selection Description
0	Disabled	Disables the function.
1	Enabled	Enables the function.

P 6.4.4.2 Auto Reset Max Attempts

Set the maximum number of automatic resets that is allowed before a manual reset is required. 0 means the drive will auto reset infinite times. Some events can not be auto reset due to hardware protection or for safety reasons.

Default Value:	3	Parameter Type:	Range (0 — 20)
Parameter Number:	1406	Unit:	–
Data Type:	UINT	Access Type:	Read/Write

P 6.4.4.3 Auto Reset Time Interval

Set the time interval from when an event happens to when it is automatically reset.

Default Value:	10	Parameter Type:	Range (1 — 600)
Parameter Number:	1407	Unit:	s
Data Type:	REAL	Access Type:	Read/Write

6.7.5 Operational Counters (Menu Index 6.5)

P 6.5.1 Control Unit On Time

Shows the total operating time for the control unit.

Default Value:	0	Parameter Type:	Range (0 — 4294967295)
Parameter Number:	2000	Unit:	h
Data Type:	UDINT	Access Type:	Read Only

P 6.5.2 Power Unit On Time

Shows the total operating time for the power unit. The counter only increments if the DC link is powered.

Default Value:	0	Parameter Type:	Range (0 — 4294967295)
Parameter Number:	2001	Unit:	h
Data Type:	UDINT	Access Type:	Read Only

P 6.5.3 Energy Consumption

Shows the energy consumed.

Default Value:	0	Parameter Type:	Range (0 — 18446744073709600000)
-----------------------	---	------------------------	----------------------------------

Parameter Number: 2002	Unit: kWh
Data Type: ULINT	Access Type: Read Only

P 6.5.4 Ground Faults

Shows the total number of ground faults.

Default Value: 0	Parameter Type: Range (0 — 50000)
Parameter Number: 2004	Unit: –
Data Type: UINT	Access Type: Read Only

P 6.5.5 Overvoltage Faults

Shows the total number of overvoltage faults.

Default Value: 0	Parameter Type: Range (0 — 50000)
Parameter Number: 2005	Unit: –
Data Type: UINT	Access Type: Read Only

P 6.5.6 Overcurrent Faults

Shows the total number of overcurrent faults.

Default Value: 0	Parameter Type: Range (0 — 50000)
Parameter Number: 2006	Unit: –
Data Type: UINT	Access Type: Read Only

P 6.5.7 Short Circuit Faults

Shows the total number of short-circuit faults.

Default Value: 0	Parameter Type: Range (0 — 50000)
Parameter Number: 2007	Unit: –
Data Type: UINT	Access Type: Read Only

P 6.5.8 Number Of Starts

Shows the number of starts of the motor.

Default Value: 0	Parameter Type: Range (0 — 4294967295)
Parameter Number: 2008	Unit: –
Data Type: UDINT	Access Type: Read Only

P 6.5.9 Active Running Hours

Shows the total number of active running hours of the motor.

Default Value: 0	Parameter Type: Range (0 — 4294967295)
Parameter Number: 2009	Unit: h
Data Type: UDINT	Access Type: Read Only

P 6.5.10 Motor Operation Below 10 Hz

Shows the number of hours of running below 10 Hz output frequency. Low speed operation with full load may decrease motor lifetime.

Default Value:	0	Parameter Type:	Range (0 — 4294967295)
Parameter Number:	2010	Unit:	h
Data Type:	UDINT	Access Type:	Read Only

6.7.6 Backup & Restore (Menu Index 6.7)

S 6.7.1 Backup

Create a backup of parameters.

For instructions on how to create a backup using the control panel, see [3.2.13.1 Making a System Backup Using the Control Panel](#).

For instructions on how to create a backup using MyDrive® Insight, see [3.3.7.2 Backing up the Drive](#).

S 6.7.2 Restore

Restore parameters from a backup or to factory settings.

For instructions on how to restore the system configuration using the control panel, see [3.2.13.2 Restoring the System Configuration Using the Control Panel](#).

For instructions on how to restore the system configuration using MyDrive® Insight, see [3.3.7.3 Restoring the Data to the Drive](#).

6.7.7 Preventive Maintenance (Menu Index 6.8)

6.7.7.1 Setting Up Preventive Maintenance

When setting up the parameters with the control panel or MyDrive Insight, the parameters are grouped in screens as shown in the following picture.

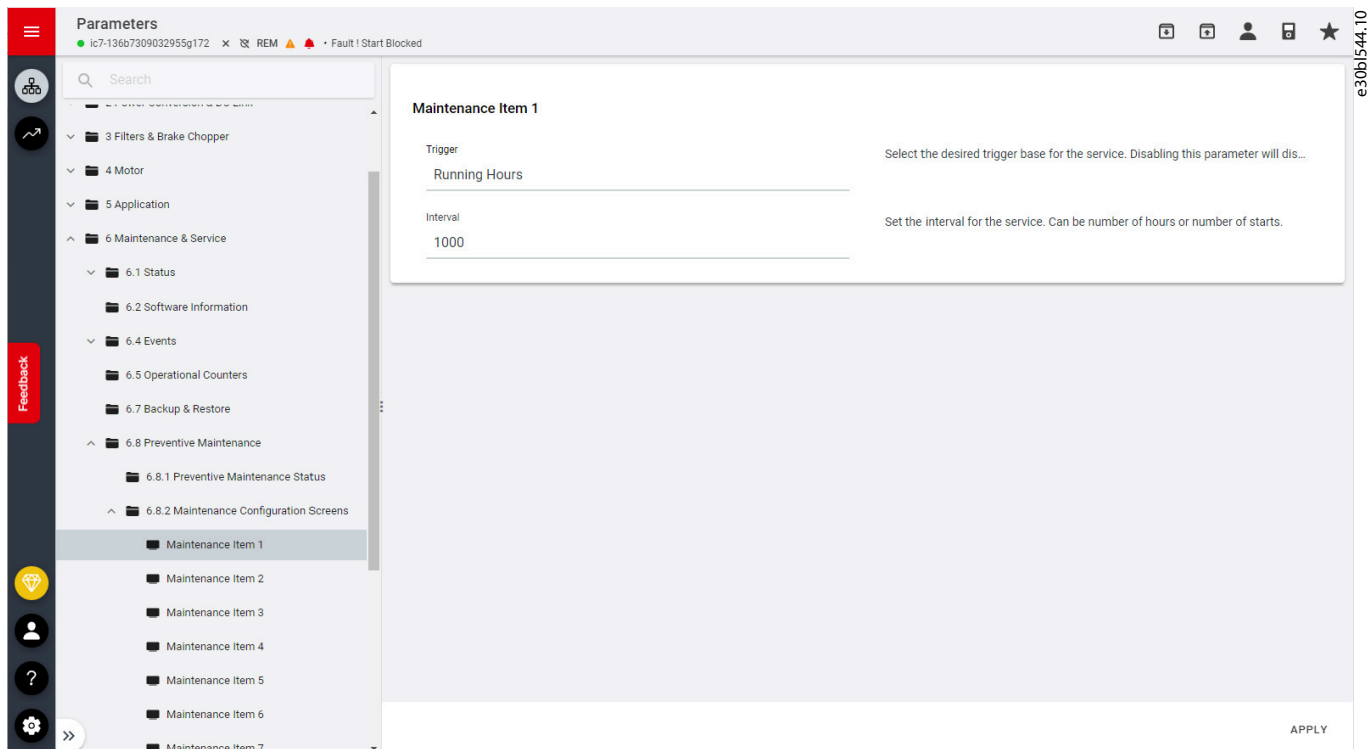

Figure 82: Preventive maintenance parameters in MyDrive Insight

1. Define the maintenance *Trigger Type*.

Select how the need for maintenance is determined. There are four trigger types:

- Disabled (default)
- Running Hours (the running hours of the motor)
- Operation Hours (the running hours of the drive)
- Number of Starts

2. Define the maintenance *Interval*. The interval is the number of hours or number of motor starts after which maintenance is called for.

3. Press *Apply* to finish setting the parameters.

When a need for maintenance is triggered, the drive issues a warning and shows the maintenance request in MyDrive Insight and on the control panel.

To remove the maintenance request, the notification must be acknowledged by clicking *OK* in MyDrive Insight or pressing the *OK* button on the control panel. Acknowledging removes the warning and schedules a new service trigger with the same values (for example 1000 running hours).

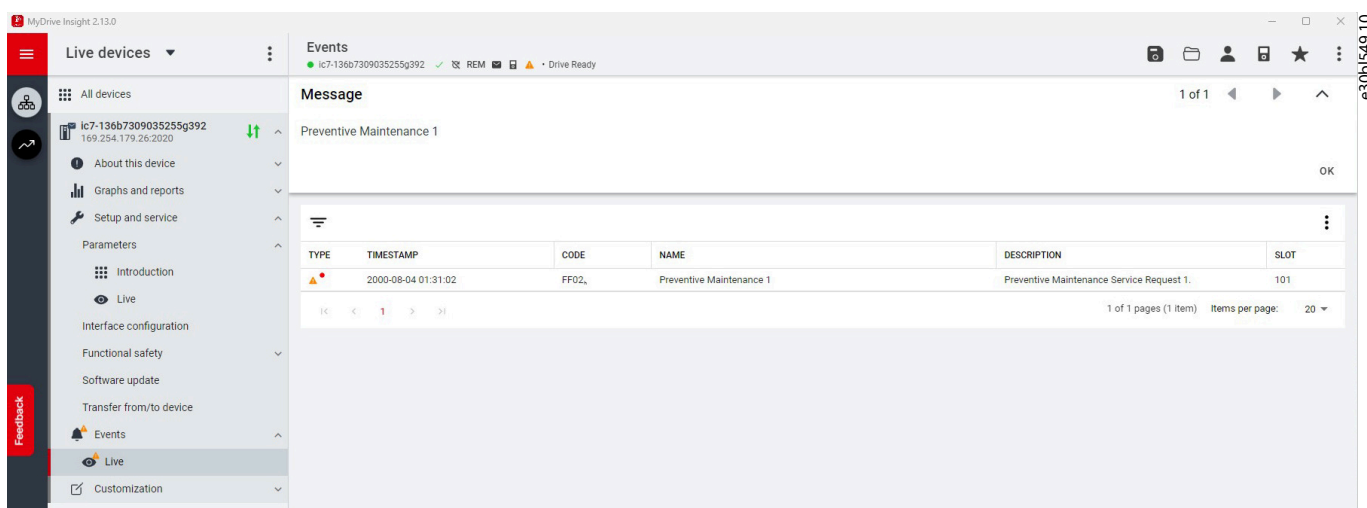

Figure 83: Maintenance warning in MyDrive Insight

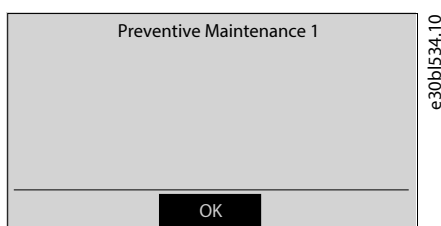

Figure 84: Maintenance warning on the control panel

6.7.7.2 Preventive Maintenance Status (Menu Index 6.8.1)

P 6.8.1.1 Preventive Maintenance status word

Shows the current status of the preventive maintenance services. Bit 0 represents item 1, bit 1 represents item 2, and so on.

Default Value:	NA	Parameter Type:	Range (0 — 65535)
Parameter Number:	7042	Unit:	–

Data Type: UINT Access Type: Read Only

P 6.8.1.2 Preventive Maintenance acknowledge word

Acknowledge a preventive maintenance service request. To acknowledge request 1, set bit 0, for request 2, set bit 1, and so on. The bits are automatically reset.

Default Value: 0 Parameter Type: Range (0 — 65535)
 Parameter Number: 7043 Unit: –
 Data Type: UINT Access Type: Read/Write

6.7.7.3 Maintenance Request Notification and Acknowledging by Fieldbus

Preventive maintenance triggers and maintenance interval parameters can be set via the fieldbus with these parameters:

Table 51: Fieldbus trigger parameters

Parameter name	Parameter number
Preventive Maintenance Trigger 1	7002
Preventive Maintenance Trigger 2	7026
Preventive Maintenance Trigger 3	7013
Preventive Maintenance Trigger 4	7014
Preventive Maintenance Trigger 5	7029
Preventive Maintenance Trigger 6	7031
Preventive Maintenance Trigger 7	7032
Preventive Maintenance Trigger 8	7033
Preventive Maintenance Trigger 9	7034
Preventive Maintenance Trigger 10	7035

Table 52: Fieldbus maintenance interval parameters

Parameter name	Parameter number
Preventive Maintenance Interval 1	7003
Preventive Maintenance Interval 2	7025
Preventive Maintenance Interval 3	7017
Preventive Maintenance Interval 4	7018
Preventive Maintenance Interval 5	7019
Preventive Maintenance Interval 6	7037
Preventive Maintenance Interval 7	7038
Preventive Maintenance Interval 8	7039
Preventive Maintenance Interval 9	7040
Preventive Maintenance Interval 10	7041

The maintenance request can also be read via the fieldbus with the *Preventive Maintenance Status Word (No. 7042)* parameter. The bits of the word represent each of the 10 maintenance items.

Table 53: Preventive Maintenance Status Word parameter

Bit	Description
0	Service request item 1
1	Service request item 2
2	Service request item 3
3	Service request item 4
4	Service request item 5
5	Service request item 6
6	Service request item 7
7	Service request item 8
8	Service request item 9
9	Service request item 10

The requests can be acknowledged via the fieldbus with the *Preventive Maintenance Acknowledge Word (No. 7043)* parameter. The bits of the word in the parameter represent each of the 10 maintenance items in the same way.

6.8 Functional Safety (Menu Index 7)

6.8.1 Functional Safety Overview

NOTICE

Select and apply the components in the safety control system appropriately to achieve the required level of operational safety. Before integrating and using STO in an installation, carry out a thorough risk analysis on the installation to determine whether the STO functionality and safety levels are appropriate and sufficient.

This parameter group contains non-safety-related parameters. They are used to configure the behavior of the drive after a functional safety event (for example, STO). Refer to Functional Safety Operating Guide for more information.

6.8.2 Status (Menu Index 7.1)

P 7.1.1 Functional Safety Status Word

Shows the functional safety status word.

Default Value:	NA	Parameter Type:	Range (* — *)
Parameter Number:	4024	Unit:	–
Data Type:	WORD	Access Type:	Read Only

6.8.3 Basic Settings (Menu Index 7.2)

P 7.2.1 Startup Acknowledge Input

Select the input for acknowledging a safe startup.

Default Value:	–	Parameter Type:	Selection
Parameter Number:	9922	Unit:	–
Data Type:	UINT	Access Type:	Read/Write

P 7.2.2 I/O Failure Acknowledge Input

Select the input for acknowledging a safe I/O failure.

Default Value:	–	Parameter Type:	Selection
Parameter Number:	9921	Unit:	–
Data Type:	UINT	Access Type:	Read/Write

6.8.4 Safe Torque Off (STO)

The Safe Torque Off (STO) function is a component in a safety control system. STO prevents the unit from generating the power required to rotate the motor. The iC7 drives are available with:

- Safe Torque Off (STO), as defined by EN IEC 61800-5-2.
- Stop category 0, as defined in EN 60204-1.

STO Activation

The STO function is activated by removing the voltages at the STO inputs of the drive. By connecting the frequency converter to external safety devices providing a safe delay, an installation for a Safe Stop 1 can be obtained. External safety devices must fulfill the required Cat./PL or SIL when connected to STO inputs.

With default settings, the drive issues a fault, trips the unit, and coasts the motor to a stop when the STO function is activated. A manual restart is required to continue operation. Use the STO function to stop the drive when a safety function is required. In normal operating mode when STO is not required, use the standard stop function instead.

6.8.5 STO (Menu Index 7.3)

P 7.3.1 Safe Torque Off Response

Select the response of the drive to the activation of Safe Torque Off.

Default Value:	14 (Fault)	Parameter Type:	Selection
Parameter Number:	9910	Unit:	–
Data Type:	UINT	Access Type:	Read/Write

The following are the selections for the parameter.

Selection Number	Selection Name	Selection Description
15	Warning	The drive issues a warning.
14	Fault	The drive issues a fault and coasts the motor.

P 7.3.2 Safe Torque Off Output

Select an output for signaling the activation of Safe Torque Off.

Default Value:	–	Parameter Type:	Selection
Parameter Number:	9911	Unit:	–
Data Type:	UINT	Access Type:	Read/Write

P 7.3.3 Safe Torque Off Acknowledge Input

Select the input for acknowledging Safe Torque Off.

Default Value:	–	Parameter Type:	Selection
Parameter Number:	9920	Unit:	–
Data Type:	UINT	Access Type:	Read/Write

6.8.6 Terminating STO and Resuming Normal Operation

1. Reapply the 24 V DC supply to safe inputs.
2. Give a reset signal (via fieldbus, digital I/O, or the control panel).

Set the STO function to restart automatically by setting the value of parameter **7.3.1 Safe Torque Off Response** from the default value **Fault (Manual reset)** to the value **Warning (Automatic reset)**. Automatic reset means that STO is terminated and normal operation is resumed, when the 24 V DC is applied to STO inputs. No reset signal is required.

6.8.7 SS1 (Menu Index 7.4)

P 7.4.1 Safe Stop 1 Response

Select the response if there is a Safe Stop 1 event (Only available with safety module).

Default Value:	0 (No response)	Parameter Type:	Selection
Parameter Number:	9901	Unit:	–
Data Type:	UINT	Access Type:	Read/Write

The following are the selections for the parameter.

Selection Number	Selection Name	Selection Description
0	No response	The drive detects that Safe Stop is activated, but relies on external action to stop. If no action is taken, a fault is generated.
1	Stop with Safe Ramp	The drive detects that Safe Stop is activated and ramps down using the configured ramp. If unsuccessful, a fault is generated.

P 7.4.3 Safe Deceleration Ramp

Set Deceleration Ramp if there is a Safe Stop event (Only available with safety module).

Default Value:	–	Parameter Type:	Range (0 — 10000)
Parameter Number:	9900	Unit:	s
Data Type:	REAL	Access Type:	Read/Write

6.9 Customization (Menu Index 8)

6.9.1 Customization Overview

This parameter group contains parameters for customizing and adapting the behavior of the drive and user interface design.

6.9.2 Status (Menu Index 8.1)

P 8.1.1 Date & Time

Shows the current system time and date.

Default Value:	–	Parameter Type:	Range (* — *)
-----------------------	---	------------------------	-----------------

Parameter Number: 2799	Unit: –
Data Type: DATE_AND_TIME	Access Type: Read/Write

P 8.1.2 Active NTP Server

Shows the active network time protocol (NTP) server.

Default Value: –	Parameter Type: Range (* — *)
Parameter Number: 6230	Unit: –
Data Type: STRING	Access Type: Read Only

P 8.1.3 Last Time Received (NTP)

Shows the last time received from a network time protocol server.

Default Value: –	Parameter Type: Range (* — *)
Parameter Number: 6235	Unit: –
Data Type: DATE_AND_TIME	Access Type: Read Only

6.9.3 Basic Settings (Menu Index 8.2)

P 8.2.2 Unit Selection

Select the unit system used.

Default Value: *	Parameter Type: Selection
Parameter Number: 2801	Unit: –
Data Type: USINT	Access Type: Read/Write

The following are the selections for the parameter.

Selection Number	Selection Name	Selection Description
0	SI (metric units)	International system of units.
1	USCS (United States customary units)	United States customary units.

P 8.2.3 Speed Unit

Select the speed unit.

Default Value: 1 (RPM)	Parameter Type: Selection
Parameter Number: 2813	Unit: –
Data Type: USINT	Access Type: Read/Write

The following are the selections for the parameter.

Selection Number	Selection Name	Selection Description
0	Hz	Use Hz as speed unit.
1	RPM	Use RPM as speed unit.

6.9.4 Control Panel (Menu Index 8.3)

6.9.4.1 General Settings (Menu Index 8.3.1)

S 8.3.1.2 Time & Date Settings

General control panel date and time settings.

Set the system time zone, and select the date and time format to be shown on the control panel.

6.9.4.2 Status Line (Menu Index 8.3.2)

P 8.3.2.1 Status Line Left

Select the parameter for the left field in the status line.

Default Value:	65001 (Actual Output Value)	Parameter Type:	Selection
Parameter Number:	4332	Unit:	–
Data Type:	UDINT	Access Type:	Read/Write

The following are the selections for the parameter.

Selection Number	Selection Name	Selection Description
0	None	Nothing selected.
65001	Actual Output Value	Shows the actual output value depending on the operation mode.
65002	Actual Reference Value	Shows the actual setpoint value depending on the operation mode.
9011	Motor Speed	Shows the actual motor speed.
9000	Motor Current	Shows the actual motor current.
9010	Motor Shaft Speed	Shows the shaft speed in RPM.
9009	Motor Torque	Shows the actual motor torque.
1708	Relative Motor Torque	Shows the motor torque in % of the nominal motor torque.
9005	Motor Voltage	Shows the actual motor voltage.
9008	Motor Shaft Power	Shows the actual power at the motor shaft.
674	Load Drooping Speed	Shows the load drooping speed.
6075	Process Controller Output	Shows the output of the process controller as normalized value (in the range 0 to 1).
6090	Feedback Value	Shows the actual value of the feedback.
1718	Speed Reference	Shows the speed reference.
6092	Setpoint Value	Shows the actual value of the setpoint.
6151	Final Speed Reference	Shows the value of the speed reference before feeding it to the speed controller.
6153	Control Panel Speed Reference	Shows the value of the speed reference given from the control panel.
6155	Local Torque Reference	Shows the local torque reference set in the control panel.
9007	Feedback Speed	Shows the feedback speed.
9044	DC-link Voltage	Shows the actual DC-link voltage.

Selection Number	Selection Name	Selection Description
9041	Grid Frequency	Shows the actual grid frequency.
9040	Line-To-Line Voltage (RMS)	Shows the average line-to-line voltage (RMS).
9048	L1-L2 Line Voltage (RMS)	Shows the L1-L2 line voltage (RMS).
9049	L2-L3 Line Voltage (RMS)	Shows the L2-L3 line voltage (RMS).
9050	L3-L1 Line Voltage (RMS)	Shows the L3-L1 line voltage (RMS).
9047	Grid Voltage Imbalance	Shows the grid voltage imbalance in %. A value greater than 3% may indicate grid problems.

P 8.3.2.2 Status Line Right

Select the parameter for the right field in the status line.

Default Value:	65002 (Actual Reference Value)	Parameter Type:	Selection
Parameter Number:	4331	Unit:	–
Data Type:	UDINT	Access Type:	Read/Write

The following are the selections for the parameter.

Selection Number	Selection Name	Selection Description
0	None	Nothing selected.
65001	Actual Output Value	Shows the actual output value depending on the operation mode.
65002	Actual Reference Value	Shows the actual setpoint value depending on the operation mode.
9011	Motor Speed	Shows the actual motor speed.
9000	Motor Current	Shows the actual motor current.
9010	Motor Shaft Speed	Shows the shaft speed in RPM.
9009	Motor Torque	Shows the actual motor torque.
1708	Relative Motor Torque	Shows the motor torque in % of the nominal motor torque.
9005	Motor Voltage	Shows the actual motor voltage.
9008	Motor Shaft Power	Shows the actual power at the motor shaft.
674	Load Drooping Speed	Shows the load drooping speed.
6075	Process Controller Output	Shows the output of the process controller as normalized value (in the range 0 to 1).
6090	Feedback Value	Shows the actual value of the feedback.
1718	Speed Reference	Shows the speed reference.
6092	Setpoint Value	Shows the actual value of the setpoint.
6151	Final Speed Reference	Shows the value of the speed reference before feeding it to the speed controller.
6153	Control Panel Speed Reference	Shows the value of the speed reference given from the control panel.
6155	Local Torque Reference	Shows the local torque reference set in the control panel.

Selection Number	Selection Name	Selection Description
9007	Feedback Speed	Shows the feedback speed.
9044	DC-link Voltage	Shows the actual DC-link voltage.
9041	Grid Frequency	Shows the actual grid frequency.
9040	Line-To-Line Voltage (RMS)	Shows the average line-to-line voltage (RMS).
9048	L1-L2 Line Voltage (RMS)	Shows the L1-L2 line voltage (RMS).
9049	L2-L3 Line Voltage (RMS)	Shows the L2-L3 line voltage (RMS).
9050	L3-L1 Line Voltage (RMS)	Shows the L3-L1 line voltage (RMS).
9047	Grid Voltage Imbalance	Shows the grid voltage imbalance in %. A value greater than 3% may indicate grid problems.

P 8.3.2.3 Status Line Center

Select the parameter for the center field in the status line.

Default Value:	9008 (Motor Shaft Power)	Parameter Type:	Selection
Parameter Number:	4333	Unit:	–
Data Type:	UDINT	Access Type:	Read/Write

The following are the selections for the parameter.

Selection Number	Selection Name	Selection Description
0	None	Nothing selected.
65001	Actual Output Value	Shows the actual output value depending on the operation mode.
65002	Actual Reference Value	Shows the actual setpoint value depending on the operation mode.
9011	Motor Speed	Shows the actual motor speed.
9000	Motor Current	Shows the actual motor current.
9010	Motor Shaft Speed	Shows the shaft speed in RPM.
9009	Motor Torque	Shows the actual motor torque.
1708	Relative Motor Torque	Shows the motor torque in % of the nominal motor torque.
9005	Motor Voltage	Shows the actual motor voltage.
9008	Motor Shaft Power	Shows the actual power at the motor shaft.
674	Load Drooping Speed	Shows the load drooping speed.
6075	Process Controller Output	Shows the output of the process controller as normalized value (in the range 0 to 1).
6090	Feedback Value	Shows the actual value of the feedback.
1718	Speed Reference	Shows the speed reference.
6092	Setpoint Value	Shows the actual value of the setpoint.
6151	Final Speed Reference	Shows the value of the speed reference before feeding it to the speed controller.

Selection Number	Selection Name	Selection Description
6153	Control Panel Speed Reference	Shows the value of the speed reference given from the control panel.
6155	Local Torque Reference	Shows the local torque reference set in the control panel.
9007	Feedback Speed	Shows the feedback speed.
9044	DC-link Voltage	Shows the actual DC-link voltage.
9041	Grid Frequency	Shows the actual grid frequency.
9040	Line-To-Line Voltage (RMS)	Shows the average line-to-line voltage (RMS).
9048	L1-L2 Line Voltage (RMS)	Shows the L1-L2 line voltage (RMS).
9049	L2-L3 Line Voltage (RMS)	Shows the L2-L3 line voltage (RMS).
9050	L3-L1 Line Voltage (RMS)	Shows the L3-L1 line voltage (RMS).
9047	Grid Voltage Imbalance	Shows the grid voltage imbalance in %. A value greater than 3% may indicate grid problems.

6.9.4.3 Status Screen 1 (Menu Index 8.3.3)

P 8.3.3.1 Status Value 1.1

Select the parameter for status value 1.1.

Default Value:	65001 (Actual Output Value)	Parameter Type:	Selection
Parameter Number:	300	Unit:	–
Data Type:	UDINT	Access Type:	Read/Write

The following are the selections for the parameter.

Selection Number	Selection Name	Selection Description
0	None	Nothing selected.
65001	Actual Output Value	Shows the actual output value depending on the operation mode.
65002	Actual Reference Value	Shows the actual setpoint value depending on the operation mode.
9011	Motor Speed	Shows the actual motor speed.
9000	Motor Current	Shows the actual motor current.
9010	Motor Shaft Speed	Shows the shaft speed in RPM.
9009	Motor Torque	Shows the actual motor torque.
1708	Relative Motor Torque	Shows the motor torque in % of the nominal motor torque.
9005	Motor Voltage	Shows the actual motor voltage.
9008	Motor Shaft Power	Shows the actual power at the motor shaft.
674	Load Drooping Speed	Shows the load drooping speed.
6075	Process Controller Output	Shows the output of the process controller as normalized value (in the range 0 to 1).
6090	Feedback Value	Shows the actual value of the feedback.

Selection Number	Selection Name	Selection Description
1718	Speed Reference	Shows the speed reference.
6092	Setpoint Value	Shows the actual value of the setpoint.
6151	Final Speed Reference	Shows the value of the speed reference before feeding it to the speed controller.
6153	Control Panel Speed Reference	Shows the value of the speed reference given from the control panel.
6155	Local Torque Reference	Shows the local torque reference set in the control panel.
9007	Feedback Speed	Shows the feedback speed.
9044	DC-link Voltage	Shows the actual DC-link voltage.
9041	Grid Frequency	Shows the actual grid frequency.
9040	Line-To-Line Voltage (RMS)	Shows the average line-to-line voltage (RMS).
9048	L1-L2 Line Voltage (RMS)	Shows the L1-L2 line voltage (RMS).
9049	L2-L3 Line Voltage (RMS)	Shows the L2-L3 line voltage (RMS).
9050	L3-L1 Line Voltage (RMS)	Shows the L3-L1 line voltage (RMS).
9047	Grid Voltage Imbalance	Shows the grid voltage imbalance in %. A value greater than 3% may indicate grid problems.

P 8.3.3.2 Status Value 1.2

Select the parameter for status value 1.2.

Default Value:	0 (None)	Parameter Type:	Selection
Parameter Number:	301	Unit:	–
Data Type:	UDINT	Access Type:	Read/Write

The following are the selections for the parameter.

Selection Number	Selection Name	Selection Description
0	None	Nothing selected.
9011	Motor Speed	Shows the actual motor speed.
9000	Motor Current	Shows the actual motor current.
9010	Motor Shaft Speed	Shows the shaft speed in RPM.
9009	Motor Torque	Shows the actual motor torque.
1708	Relative Motor Torque	Shows the motor torque in % of the nominal motor torque.
9005	Motor Voltage	Shows the actual motor voltage.
9008	Motor Shaft Power	Shows the actual power at the motor shaft.
674	Load Drooping Speed	Shows the load drooping speed.
6075	Process Controller Output	Shows the output of the process controller as normalized value (in the range 0 to 1).
6090	Feedback Value	Shows the actual value of the feedback.

Selection Number	Selection Name	Selection Description
1718	Speed Reference	Shows the speed reference.
6092	Setpoint Value	Shows the actual value of the setpoint.
6151	Final Speed Reference	Shows the value of the speed reference before feeding it to the speed controller.
6153	Control Panel Speed Reference	Shows the value of the speed reference given from the control panel.
6155	Local Torque Reference	Shows the local torque reference set in the control panel.
9007	Feedback Speed	Shows the feedback speed.
9044	DC-link Voltage	Shows the actual DC-link voltage.
9041	Grid Frequency	Shows the actual grid frequency.
9040	Line-To-Line Voltage (RMS)	Shows the average line-to-line voltage (RMS).
9048	L1-L2 Line Voltage (RMS)	Shows the L1-L2 line voltage (RMS).
9049	L2-L3 Line Voltage (RMS)	Shows the L2-L3 line voltage (RMS).
9050	L3-L1 Line Voltage (RMS)	Shows the L3-L1 line voltage (RMS).
9047	Grid Voltage Imbalance	Shows the grid voltage imbalance in %. A value greater than 3% may indicate grid problems.

P 8.3.3.3 Status Value 1.3

Select the parameter for status value 1.3.

Default Value:	0 (None)	Parameter Type:	Selection
Parameter Number:	302	Unit:	–
Data Type:	UDINT	Access Type:	Read/Write

The following are the selections for the parameter.

Selection Number	Selection Name	Selection Description
0	None	Nothing selected.
9011	Motor Speed	Shows the actual motor speed.
9000	Motor Current	Shows the actual motor current.
9010	Motor Shaft Speed	Shows the shaft speed in RPM.
9009	Motor Torque	Shows the actual motor torque.
1708	Relative Motor Torque	Shows the motor torque in % of the nominal motor torque.
9005	Motor Voltage	Shows the actual motor voltage.
9008	Motor Shaft Power	Shows the actual power at the motor shaft.
674	Load Drooping Speed	Shows the load drooping speed.
6075	Process Controller Output	Shows the output of the process controller as normalized value (in the range 0 to 1).
6090	Feedback Value	Shows the actual value of the feedback.

Selection Number	Selection Name	Selection Description
1718	Speed Reference	Shows the speed reference.
6092	Setpoint Value	Shows the actual value of the setpoint.
6151	Final Speed Reference	Shows the value of the speed reference before feeding it to the speed controller.
6153	Control Panel Speed Reference	Shows the value of the speed reference given from the control panel.
6155	Local Torque Reference	Shows the local torque reference set in the control panel.
9007	Feedback Speed	Shows the feedback speed.
9044	DC-link Voltage	Shows the actual DC-link voltage.
9041	Grid Frequency	Shows the actual grid frequency.
9040	Line-To-Line Voltage (RMS)	Shows the average line-to-line voltage (RMS).
9048	L1-L2 Line Voltage (RMS)	Shows the L1-L2 line voltage (RMS).
9049	L2-L3 Line Voltage (RMS)	Shows the L2-L3 line voltage (RMS).
9050	L3-L1 Line Voltage (RMS)	Shows the L3-L1 line voltage (RMS).
9047	Grid Voltage Imbalance	Shows the grid voltage imbalance in %. A value greater than 3% may indicate grid problems.

P 8.3.3.4 Status Value 1.4

Select the parameter for status value 1.4.

Default Value:	0 (None)	Parameter Type:	Selection
Parameter Number:	303	Unit:	–
Data Type:	UDINT	Access Type:	Read/Write

The following are the selections for the parameter.

Selection Number	Selection Name	Selection Description
0	None	Nothing selected.
9011	Motor Speed	Shows the actual motor speed.
9000	Motor Current	Shows the actual motor current.
9010	Motor Shaft Speed	Shows the shaft speed in RPM.
9009	Motor Torque	Shows the actual motor torque.
1708	Relative Motor Torque	Shows the motor torque in % of the nominal motor torque.
9005	Motor Voltage	Shows the actual motor voltage.
9008	Motor Shaft Power	Shows the actual power at the motor shaft.
674	Load Drooping Speed	Shows the load drooping speed.
6075	Process Controller Output	Shows the output of the process controller as normalized value (in the range 0 to 1).
6090	Feedback Value	Shows the actual value of the feedback.

Selection Number	Selection Name	Selection Description
1718	Speed Reference	Shows the speed reference.
6092	Setpoint Value	Shows the actual value of the setpoint.
6151	Final Speed Reference	Shows the value of the speed reference before feeding it to the speed controller.
6153	Control Panel Speed Reference	Shows the value of the speed reference given from the control panel.
6155	Local Torque Reference	Shows the local torque reference set in the control panel.
9007	Feedback Speed	Shows the feedback speed.
9044	DC-link Voltage	Shows the actual DC-link voltage.
9041	Grid Frequency	Shows the actual grid frequency.
9040	Line-To-Line Voltage (RMS)	Shows the average line-to-line voltage (RMS).
9048	L1-L2 Line Voltage (RMS)	Shows the L1-L2 line voltage (RMS).
9049	L2-L3 Line Voltage (RMS)	Shows the L2-L3 line voltage (RMS).
9050	L3-L1 Line Voltage (RMS)	Shows the L3-L1 line voltage (RMS).
9047	Grid Voltage Imbalance	Shows the grid voltage imbalance in %. A value greater than 3% may indicate grid problems.

P 8.3.3.5 Status Value 1.5

Select the parameter for status value 1.5.

Default Value:	0 (None)	Parameter Type:	Selection
Parameter Number:	304	Unit:	–
Data Type:	UDINT	Access Type:	Read/Write

The following are the selections for the parameter.

Selection Number	Selection Name	Selection Description
0	None	Nothing selected.
9011	Motor Speed	Shows the actual motor speed.
9000	Motor Current	Shows the actual motor current.
9010	Motor Shaft Speed	Shows the shaft speed in RPM.
9009	Motor Torque	Shows the actual motor torque.
1708	Relative Motor Torque	Shows the motor torque in % of the nominal motor torque.
9005	Motor Voltage	Shows the actual motor voltage.
9008	Motor Shaft Power	Shows the actual power at the motor shaft.
674	Load Drooping Speed	Shows the load drooping speed.
6075	Process Controller Output	Shows the output of the process controller as normalized value (in the range 0 to 1).
6090	Feedback Value	Shows the actual value of the feedback.

Selection Number	Selection Name	Selection Description
1718	Speed Reference	Shows the speed reference.
6092	Setpoint Value	Shows the actual value of the setpoint.
6151	Final Speed Reference	Shows the value of the speed reference before feeding it to the speed controller.
6153	Control Panel Speed Reference	Shows the value of the speed reference given from the control panel.
6155	Local Torque Reference	Shows the local torque reference set in the control panel.
9007	Feedback Speed	Shows the feedback speed.
9044	DC-link Voltage	Shows the actual DC-link voltage.
9041	Grid Frequency	Shows the actual grid frequency.
9040	Line-To-Line Voltage (RMS)	Shows the average line-to-line voltage (RMS).
9048	L1-L2 Line Voltage (RMS)	Shows the L1-L2 line voltage (RMS).
9049	L2-L3 Line Voltage (RMS)	Shows the L2-L3 line voltage (RMS).
9050	L3-L1 Line Voltage (RMS)	Shows the L3-L1 line voltage (RMS).
9047	Grid Voltage Imbalance	Shows the grid voltage imbalance in %. A value greater than 3% may indicate grid problems.

6.9.4.4 Status Screen 2 (Menu Index 8.3.4)

P 8.3.4.1 Status Value 2.1

Select the parameter for status value 2.1.

Default Value:	9010 (Motor Shaft Speed)	Parameter Type:	Selection
Parameter Number:	310	Unit:	–
Data Type:	UDINT	Access Type:	Read/Write

The following are the selections for the parameter.

Selection Number	Selection Name	Selection Description
0	None	Nothing selected.
9011	Motor Speed	Shows the actual motor speed.
9000	Motor Current	Shows the actual motor current.
9010	Motor Shaft Speed	Shows the shaft speed in RPM.
9009	Motor Torque	Shows the actual motor torque.
1708	Relative Motor Torque	Shows the motor torque in % of the nominal motor torque.
9005	Motor Voltage	Shows the actual motor voltage.
9008	Motor Shaft Power	Shows the actual power at the motor shaft.
674	Load Drooping Speed	Shows the load drooping speed.
6075	Process Controller Output	Shows the output of the process controller as normalized value (in the range 0 to 1).

Selection Number	Selection Name	Selection Description
6090	Feedback Value	Shows the actual value of the feedback.
1718	Speed Reference	Shows the speed reference.
6092	Setpoint Value	Shows the actual value of the setpoint.
6151	Final Speed Reference	Shows the value of the speed reference before feeding it to the speed controller.
6153	Control Panel Speed Reference	Shows the value of the speed reference given from the control panel.
6155	Local Torque Reference	Shows the local torque reference set in the control panel.
9007	Feedback Speed	Shows the feedback speed.
9044	DC-link Voltage	Shows the actual DC-link voltage.
9041	Grid Frequency	Shows the actual grid frequency.
9040	Line-To-Line Voltage (RMS)	Shows the average line-to-line voltage (RMS).
9048	L1-L2 Line Voltage (RMS)	Shows the L1-L2 line voltage (RMS).
9049	L2-L3 Line Voltage (RMS)	Shows the L2-L3 line voltage (RMS).
9050	L3-L1 Line Voltage (RMS)	Shows the L3-L1 line voltage (RMS).
9047	Grid Voltage Imbalance	Shows the grid voltage imbalance in %. A value greater than 3% may indicate grid problems.

P 8.3.4.2 Status Value 2.2

Select the parameter for status value 2.2.

Default Value:	9009 (Motor Torque)	Parameter Type:	Selection
Parameter Number:	311	Unit:	–
Data Type:	UDINT	Access Type:	Read/Write

The following are the selections for the parameter.

Selection Number	Selection Name	Selection Description
0	None	Nothing selected.
9011	Motor Speed	Shows the actual motor speed.
9000	Motor Current	Shows the actual motor current.
9010	Motor Shaft Speed	Shows the shaft speed in RPM.
9009	Motor Torque	Shows the actual motor torque.
1708	Relative Motor Torque	Shows the motor torque in % of the nominal motor torque.
9005	Motor Voltage	Shows the actual motor voltage.
9008	Motor Shaft Power	Shows the actual power at the motor shaft.
674	Load Drooping Speed	Shows the load drooping speed.
6075	Process Controller Output	Shows the output of the process controller as normalized value (in the range 0 to 1).

Selection Number	Selection Name	Selection Description
6090	Feedback Value	Shows the actual value of the feedback.
1718	Speed Reference	Shows the speed reference.
6092	Setpoint Value	Shows the actual value of the setpoint.
6151	Final Speed Reference	Shows the value of the speed reference before feeding it to the speed controller.
6153	Control Panel Speed Reference	Shows the value of the speed reference given from the control panel.
6155	Local Torque Reference	Shows the local torque reference set in the control panel.
9007	Feedback Speed	Shows the feedback speed.
9044	DC-link Voltage	Shows the actual DC-link voltage.
9041	Grid Frequency	Shows the actual grid frequency.
9040	Line-To-Line Voltage (RMS)	Shows the average line-to-line voltage (RMS).
9048	L1-L2 Line Voltage (RMS)	Shows the L1-L2 line voltage (RMS).
9049	L2-L3 Line Voltage (RMS)	Shows the L2-L3 line voltage (RMS).
9050	L3-L1 Line Voltage (RMS)	Shows the L3-L1 line voltage (RMS).
9047	Grid Voltage Imbalance	Shows the grid voltage imbalance in %. A value greater than 3% may indicate grid problems.

P 8.3.4.3 Status Value 2.3

Select the parameter for status value 2.3.

Default Value:	9008 (Motor Shaft Power)	Parameter Type:	Selection
Parameter Number:	312	Unit:	–
Data Type:	UDINT	Access Type:	Read/Write

The following are the selections for the parameter.

Selection Number	Selection Name	Selection Description
0	None	Nothing selected.
9011	Motor Speed	Shows the actual motor speed.
9000	Motor Current	Shows the actual motor current.
9010	Motor Shaft Speed	Shows the shaft speed in RPM.
9009	Motor Torque	Shows the actual motor torque.
1708	Relative Motor Torque	Shows the motor torque in % of the nominal motor torque.
9005	Motor Voltage	Shows the actual motor voltage.
9008	Motor Shaft Power	Shows the actual power at the motor shaft.
674	Load Drooping Speed	Shows the load drooping speed.
6075	Process Controller Output	Shows the output of the process controller as normalized value (in the range 0 to 1).

Selection Number	Selection Name	Selection Description
6090	Feedback Value	Shows the actual value of the feedback.
1718	Speed Reference	Shows the speed reference.
6092	Setpoint Value	Shows the actual value of the setpoint.
6151	Final Speed Reference	Shows the value of the speed reference before feeding it to the speed controller.
6153	Control Panel Speed Reference	Shows the value of the speed reference given from the control panel.
6155	Local Torque Reference	Shows the local torque reference set in the control panel.
9007	Feedback Speed	Shows the feedback speed.
9044	DC-link Voltage	Shows the actual DC-link voltage.
9041	Grid Frequency	Shows the actual grid frequency.
9040	Line-To-Line Voltage (RMS)	Shows the average line-to-line voltage (RMS).
9048	L1-L2 Line Voltage (RMS)	Shows the L1-L2 line voltage (RMS).
9049	L2-L3 Line Voltage (RMS)	Shows the L2-L3 line voltage (RMS).
9050	L3-L1 Line Voltage (RMS)	Shows the L3-L1 line voltage (RMS).
9047	Grid Voltage Imbalance	Shows the grid voltage imbalance in %. A value greater than 3% may indicate grid problems.

P 8.3.4.4 Status Value 2.4

Select the parameter for status value 2.4.

Default Value:	0 (None)	Parameter Type:	Selection
Parameter Number:	313	Unit:	–
Data Type:	UDINT	Access Type:	Read/Write

The following are the selections for the parameter.

Selection Number	Selection Name	Selection Description
0	None	Nothing selected.
9011	Motor Speed	Shows the actual motor speed.
9000	Motor Current	Shows the actual motor current.
9010	Motor Shaft Speed	Shows the shaft speed in RPM.
9009	Motor Torque	Shows the actual motor torque.
1708	Relative Motor Torque	Shows the motor torque in % of the nominal motor torque.
9005	Motor Voltage	Shows the actual motor voltage.
9008	Motor Shaft Power	Shows the actual power at the motor shaft.
674	Load Drooping Speed	Shows the load drooping speed.
6075	Process Controller Output	Shows the output of the process controller as normalized value (in the range 0 to 1).

Selection Number	Selection Name	Selection Description
6090	Feedback Value	Shows the actual value of the feedback.
1718	Speed Reference	Shows the speed reference.
6092	Setpoint Value	Shows the actual value of the setpoint.
6151	Final Speed Reference	Shows the value of the speed reference before feeding it to the speed controller.
6153	Control Panel Speed Reference	Shows the value of the speed reference given from the control panel.
6155	Local Torque Reference	Shows the local torque reference set in the control panel.
9007	Feedback Speed	Shows the feedback speed.
9044	DC-link Voltage	Shows the actual DC-link voltage.
9041	Grid Frequency	Shows the actual grid frequency.
9040	Line-To-Line Voltage (RMS)	Shows the average line-to-line voltage (RMS).
9048	L1-L2 Line Voltage (RMS)	Shows the L1-L2 line voltage (RMS).
9049	L2-L3 Line Voltage (RMS)	Shows the L2-L3 line voltage (RMS).
9050	L3-L1 Line Voltage (RMS)	Shows the L3-L1 line voltage (RMS).
9047	Grid Voltage Imbalance	Shows the grid voltage imbalance in %. A value greater than 3% may indicate grid problems.

P 8.3.4.5 Status Value 2.5

Select the parameter for status value 2.5.

Default Value:	0 (None)	Parameter Type:	Selection
Parameter Number:	314	Unit:	–
Data Type:	UDINT	Access Type:	Read/Write

The following are the selections for the parameter.

Selection Number	Selection Name	Selection Description
0	None	Nothing selected.
9011	Motor Speed	Shows the actual motor speed.
9000	Motor Current	Shows the actual motor current.
9010	Motor Shaft Speed	Shows the shaft speed in RPM.
9009	Motor Torque	Shows the actual motor torque.
1708	Relative Motor Torque	Shows the motor torque in % of the nominal motor torque.
9005	Motor Voltage	Shows the actual motor voltage.
9008	Motor Shaft Power	Shows the actual power at the motor shaft.
674	Load Drooping Speed	Shows the load drooping speed.
6075	Process Controller Output	Shows the output of the process controller as normalized value (in the range 0 to 1).

Selection Number	Selection Name	Selection Description
6090	Feedback Value	Shows the actual value of the feedback.
1718	Speed Reference	Shows the speed reference.
6092	Setpoint Value	Shows the actual value of the setpoint.
6151	Final Speed Reference	Shows the value of the speed reference before feeding it to the speed controller.
6153	Control Panel Speed Reference	Shows the value of the speed reference given from the control panel.
6155	Local Torque Reference	Shows the local torque reference set in the control panel.
9007	Feedback Speed	Shows the feedback speed.
9044	DC-link Voltage	Shows the actual DC-link voltage.
9041	Grid Frequency	Shows the actual grid frequency.
9040	Line-To-Line Voltage (RMS)	Shows the average line-to-line voltage (RMS).
9048	L1-L2 Line Voltage (RMS)	Shows the L1-L2 line voltage (RMS).
9049	L2-L3 Line Voltage (RMS)	Shows the L2-L3 line voltage (RMS).
9050	L3-L1 Line Voltage (RMS)	Shows the L3-L1 line voltage (RMS).
9047	Grid Voltage Imbalance	Shows the grid voltage imbalance in %. A value greater than 3% may indicate grid problems.

6.9.5 Date & Time (Menu Index 8.4)

P 8.4.1 Time Mode

Select the time mode. Auto enables NTP.

Default Value:	1 (Auto (NTP))	Parameter Type:	Selection
Parameter Number:	6232	Unit:	–
Data Type:	USINT	Access Type:	Read/Write

The following are the selections for the parameter.

Selection Number	Selection Name	Selection Description
0	Manual	Disables NTP.
1	Auto (NTP)	

P 8.4.2 Date and Time

Set the actual time and date. The format is YYYY-MM-DD and HH:MM:SS.

Default Value:	–	Parameter Type:	Range (* — *)
Parameter Number:	2800	Unit:	–
Data Type:	DATE_AND_TIME	Access Type:	Read/Write

P 8.4.3 NTP Server 1

Set the IPv4 address of the requested NTP server 1.

Default Value:	–	Parameter Type:	Range (* — *)
Parameter Number:	6233	Unit:	–
Data Type:	STRING	Access Type:	Read/Write

P 8.4.4 NTP Server 2

Set the IPv4 address of the requested NTP server 2.

Default Value:	–	Parameter Type:	Range (* — *)
Parameter Number:	6234	Unit:	–
Data Type:	STRING	Access Type:	Read/Write

6.9.6 Logic (Menu Index 8.5)**6.9.6.1 Status (Menu Index 8.5.1)****P 8.5.1.1 Logic Speed Reference**

Shows Logic speed reference.

Default Value:	NA	Parameter Type:	Range (* — *)
Parameter Number:	21110	Unit:	Hz
Data Type:	REAL	Access Type:	Read/Write

P 8.5.1.2 Logic Torque Reference

Shows Logic torque reference.

Default Value:	NA	Parameter Type:	Range (* — *)
Parameter Number:	21111	Unit:	%
Data Type:	REAL	Access Type:	Read/Write

P 8.5.1.3 Logic Process Reference

Shows Logic process reference.

Default Value:	NA	Parameter Type:	Range (* — *)
Parameter Number:	21112	Unit:	CustomProcessUnit
Data Type:	REAL	Access Type:	Read/Write

P 8.5.1.10 Logic State

Shows the current active state in Logic.

Default Value:	NA	Parameter Type:	Selection
Parameter Number:	21094	Unit:	–
Data Type:	UINT	Access Type:	Read/Write

The following are the selections for the parameter.

Selection Number	Selection Name	Selection Description
0	No State	No state active.
1	State 1	State 1 active.
2	State 2	State 2 active.
3	State 3	State 3 active.
4	State 4	State 4 active.
5	State 5	State 5 active.

P 8.5.1.11 Time in current State

Shows the time that the current state in Logic has been active.

Default Value:	NA	Parameter Type:	Range (* — *)
Parameter Number:	21095	Unit:	s
Data Type:	REAL	Access Type:	Read/Write

6.9.7 Preconfigured Parameter Sets (Menu Index 8.6)

With the preconfigured parameter sets function, a whole set of parameters can be set at once. The function makes it possible, for example, to set all relevant parameters of a motor to the motor manufacturer's specification to get the best performance out of the motor. The parameters are set automatically when the relevant selection is selected for the preconfiguration parameter, in parameter group **8.6 Preconfigured Parameter Sets**.

If the parameters were set unintentionally, or the settings must be reverted, they can be reset to the factory defaults.

P 8.6.1 OGD Selection

Selects a predefined parameter set for the different One Gear Drive motors. The drive is set up according to the specifications of the motor manufacturer to get the best performance.

Default Value:	–	Parameter Type:	Selection
Parameter Number:	404	Unit:	–
Data Type:	UINT	Access Type:	Read/Conditional Write

6.10 I/O (Menu Index 9)

6.10.1 I/O Overview

Parameter group 9 contains the parameters for the hardware configuration of the I/Os such as terminal modes, filtering of the electrical signals and signal ranges.

This Application Guide contains only the parameter descriptions for the Basic I/O. The parameter information for option boards such as the Encoder/Resolver Option OC7M0 can be found in the iC7 Functional Extensions Operating Guide.

6.10.2 Basic I/O

6.10.2.1 Basic I/O Status (Menu Index 9.3)

P 9.3.1 Digital Input Status

Description: Shows the digital input I/O word. Each bit represents the status of a digital input.

Default Value: NA	Parameter Type: Range (* — *)	Parameter Number: 1614
Unit: -	Data Type: WORD	Access Type: Read Only

Table 54: I/O Digital Input Status Bits

Bit	Description
00	DigIn13
01	DigIn14
02	DigIn15
03	DigIn16
04	DigIn17
05	DigIn18
06–15	Not used

P 9.3.2 Digital Output Status

Description: Shows the digital output I/O word. Each bit represents the status of a digital output.

Default Value: NA	Parameter Type: Range (* — *)	Parameter Number: 1615
Unit: -	Data Type: WORD	Access Type: Read Only

Table 55: I/O Digital Output Status Bits

Bit	Description
00–01	Not used
02	DigOut15
03	DigOut16
04–11	Not used
12	Relay02
13	Relay05
14–15	Not used

P 9.3.3 T31 Analog Output Value

Description: Shows the actual value of the terminal.

Default Value: NA	Parameter Type: Range (0 — 20)	Parameter Number: 1613
Unit: -	Data Type: REAL	Access Type: Read Only

P 9.3.4 T33 Analog Input Value

Description: Shows the actual value of the terminal.

Default Value: NA	Parameter Type: Range (-20 — 20)	Parameter Number: 1611
Unit: -	Data Type: REAL	Access Type: Read Only

P 9.3.5 T34 Analog Input Value

Description: Shows the actual value of the terminal.

Default Value: NA	Parameter Type: Range (-20 — 20)	Parameter Number: 1612
Unit: -	Data Type: REAL	Access Type: Read Only

P 9.3.6 T34 Temperature Value

Description: Shows the measured temperature of the terminal.

Default Value: NA	Parameter Type: Range (-1000 — 1000)	Parameter Number: 1616
Unit: °C	Data Type: REAL	Access Type: Read Only

6.10.2.2 Digital Inputs/Outputs (Menu Index 9.4)

6.10.2.2.1 Pulse Input

A digital input can be configured to be a pulse input with the corresponding mode parameter. The pulse input can be used as a speed reference, similarly to how an analog input signal works. The pulse input can come from a sensor, an HTL encoder, or other devices.

When pulse input is selected as the input type, the only active parameters for that input are the pulse min. and max. frequency parameters. The right filter is selected automatically for the incoming signal by the drive, so the parameters for the filters are not active when pulse input is selected.

The set pulse minimum and maximum frequencies correspond to the set minimum and maximum speed references defined in parameter group **5.8.4 Speed Reference**.

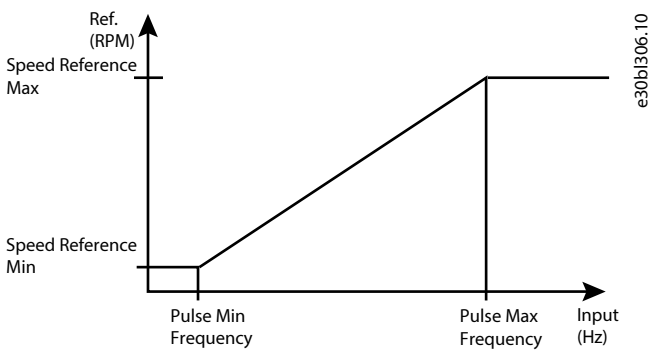

Figure 85: Pulse Input

6.10.2.2.2 General Settings (Menu Index 9.4.1)

P 9.4.1.1 Digital Input Logic

Description: Set the operating logic for all digital inputs.

Default Value: 2 [PNP mode]	Parameter Type: Selection	Parameter Number: 2261
Unit: -	Data Type: UINT	Access Type: Read/Write

The following are the selections for the parameter.

Selection Number	Selection Name	Selection Description
1	NPN mode	Open collector sink (NPN).
2	PNP mode	Open collector source (PNP).

6.10.2.2.3 Input T13 (Menu Index 9.4.2)

P 9.4.2.1 T13 Terminal Mode

Description: Select the mode for the terminal.

Default Value: 3 [Digital input]	Parameter Type: Selection	Parameter Number: 2015
Unit: -	Data Type: UINT	Access Type: Read/Write

The following are the selections for the parameter.

Selection Number	Selection Name	Selection Description
0	Inactive	
3	Digital input	The terminal is configured as boolean input (true/false).
4	Pulse input	The terminal is configured as pulse input. The frequency represents an analog value.

P 9.4.2.2 T13 Signal Inversion

Description: Select whether the signal of the terminal is inverted.

Default Value: 0 [Non-Inverted]	Parameter Type: Selection	Parameter Number: 2291
Unit: -	Data Type: UINT	Access Type: Read/Write

The following are the selections for the parameter.

Selection Number	Selection Name	Selection Description
0	Non-Inverted	The signal is not inverted.
1	Inverted	The signal is logically inverted.

P 9.4.2.3 T13 Fast Debounce Filtering Time

Description: Set the fast debounce filtering time for the terminal.

Default Value:	Parameter Type: Range (0.00 — 63.50)	Parameter Number: 2285
Unit: μ s	Data Type: REAL	Access Type: Read/Write

P 9.4.2.4 T13 Standard Debounce Filtering Time

Description: Set the standard debounce filtering time for the terminal.

Default Value: 5.00	Parameter Type: Range (0.00 — 127.00)	Parameter Number: 2024
Unit: ms	Data Type: REAL	Access Type: Read/Write

P 9.4.2.5 T13 Reaction Time

Description: Select the reaction time for the debounce filter.

Default Value: 0 [Standard reaction time (1ms tick)]	Parameter Type: Selection	Parameter Number: 2025
Unit: -	Data Type: UINT	Access Type: Read/Write

The following are the selections for the parameter.

Selection Number	Selection Name	Selection Description
0	Standard reaction time (1ms tick)	Use the digital input in the same way as other inputs.
1	Fast reaction time (0.5 μ s tick)	Enables a fast reaction time for a certain event via digital input.

P 9.4.2.6 T13 Trigger Mode

Description: Select the trigger mode for the digital input.

Default Value: 0 [None]	Parameter Type: Selection	Parameter Number: 2026
Unit: -	Data Type: UINT	Access Type: Read/Write

The following are the selections for the parameter.

Selection Number	Selection Name	Selection Description
0	None	No event trigger.
1	Rising Edge	Trigger an event at the rising edge.
2	Falling Edge	Trigger an event at the falling edge.
3	Both Edges	Trigger an event at both the rising and falling edges.

P 9.4.2.7 T13 Pulse Min. Frequency

Description: Set the frequency representing 0% of the signal.

Default Value:	Parameter Type: Range (0 — 110000)	Parameter Number: 2027
Unit: Hz	Data Type: REAL	Access Type: Read/Write

P 9.4.2.8 T13 Pulse Max. Frequency

Description: Set the frequency representing 100% of the signal.

Default Value: 110000	Parameter Type: Range (0 — 110000)	Parameter Number: 2028
Unit: Hz	Data Type: REAL	Access Type: Read/Write

6.10.2.2.4 Input T14 (Menu Index 9.4.3)

P 9.4.3.1 T14 Terminal Mode

Description: Select the mode for the terminal.

Default Value: 3 [Digital input]	Parameter Type: Selection	Parameter Number: 2016
Unit: -	Data Type: UINT	Access Type: Read/Write

The following are the selections for the parameter.

Selection Number	Selection Name	Selection Description
0	Inactive	
3	Digital input	The terminal is configured as boolean input (true/false).
4	Pulse input	The terminal is configured as pulse input. The frequency represents an analog value.

P 9.4.3.2 T14 Signal Inversion

Description: Select whether the signal of the terminal is inverted.

Default Value: 0 [Non-Inverted]	Parameter Type: Selection	Parameter Number: 2292
Unit: -	Data Type: UINT	Access Type: Read/Write

The following are the selections for the parameter.

Selection Number	Selection Name	Selection Description
0	Non-Inverted	The signal is not inverted.
1	Inverted	The signal is logically inverted.

P 9.4.3.3 T14 Fast Debounce Filtering Time

Description: Set the fast debounce filtering time for the terminal.

Default Value:	Parameter Type: Range (0.00 — 63.50)	Parameter Number: 2286
Unit: μ s	Data Type: REAL	Access Type: Read/Write

P 9.4.3.4 T14 Standard Debounce Filtering Time

Description: Set the standard debounce filtering time for the terminal.

Default Value: 5.00	Parameter Type: Range (0.00 — 127.00)	Parameter Number: 2029
Unit: ms	Data Type: REAL	Access Type: Read/Write

P 9.4.3.5 T14 Reaction Time

Description: Select the reaction time for the debounce filter.

Default Value: 0 [Standard reaction time (1ms tick)]	Parameter Type: Selection	Parameter Number: 2030
Unit: -	Data Type: UINT	Access Type: Read/Write

The following are the selections for the parameter.

Selection Number	Selection Name	Selection Description
0	Standard reaction time (1ms tick)	Use the digital input in the same way as other inputs.
1	Fast reaction time (0.5 μ s tick)	Enables a fast reaction time for a certain event via digital input.

P 9.4.3.6 T14 Trigger Mode

Description: Select the trigger mode for the digital input.

Default Value: 0 [None]	Parameter Type: Selection	Parameter Number: 2031
Unit: -	Data Type: UINT	Access Type: Read/Write

The following are the selections for the parameter.

Selection Number	Selection Name	Selection Description
0	None	No event trigger.
1	Rising Edge	Trigger an event at the rising edge.
2	Falling Edge	Trigger an event at the falling edge.
3	Both Edges	Trigger an event at both the rising and falling edges.

P 9.4.3.7 T14 Pulse Min. Frequency

Description: Set the frequency representing 0% of the signal.

Default Value:	Parameter Type: Range (0 — 110000)	Parameter Number: 2032
Unit: Hz	Data Type: REAL	Access Type: Read/Write

P 9.4.3.8 T14 Pulse Max. Frequency

Description: Set the frequency representing 100% of the signal.

Default Value: 110000	Parameter Type: Range (0 — 110000)	Parameter Number: 2033
Unit: Hz	Data Type: REAL	Access Type: Read/Write

6.10.2.2.5 Input/Output T15 (Menu Index 9.4.4)

P 9.4.4.1 T15 Terminal Mode

Description: Select the mode for the terminal.

Default Value: 3 [Digital input]	Parameter Type: Selection	Parameter Number: 2022
Unit: -	Data Type: UINT	Access Type: Read/Write

The following are the selections for the parameter.

Selection Number	Selection Name	Selection Description
0	Inactive	
1	Digital Output	Configures the terminal as boolean output true/false.
2	Pulse Output	Configures the terminal as analog output based on pulse frequency.
3	Digital input	The terminal is configured as boolean input (true/false).
4	Pulse input	The terminal is configured as pulse input. The frequency represents an analog value.

P 9.4.4.2 T15 Signal Inversion

Description: Select whether the signal of the terminal is inverted.

Default Value: 0 [Non-Inverted]	Parameter Type: Selection	Parameter Number: 2295
Unit: -	Data Type: UINT	Access Type: Read/Write

The following are the selections for the parameter.

Selection Number	Selection Name	Selection Description
0	Non-Inverted	The signal is not inverted.
1	Inverted	The signal is logically inverted.

P 9.4.4.3 T15 Fast Debounce Filtering Time

Description: Set the fast debounce filtering time for the terminal.

Default Value:	Parameter Type: Range (0.00 — 63.50)	Parameter Number: 2289
Unit: μ s	Data Type: REAL	Access Type: Read/Write

P 9.4.4.4 T15 Standard Debounce Filtering Time

Description: Set the standard debounce filtering time for the terminal.

Default Value: 5.00	Parameter Type: Range (0.00 — 127.00)	Parameter Number: 2297
Unit: ms	Data Type: REAL	Access Type: Read/Write

P 9.4.4.5 T15 Reaction Time

Description: Select the reaction time for the debounce filter.

Default Value: 0 [Standard reaction time (1ms tick)]	Parameter Type: Selection	Parameter Number: 2299
Unit: -	Data Type: UINT	Access Type: Read/Write

The following are the selections for the parameter.

Selection Number	Selection Name	Selection Description
0	Standard reaction time (1ms tick)	Use the digital input in the same way as other inputs.
1	Fast reaction time (0.5 μ s tick)	Enables a fast reaction time for a certain event via digital input.

P 9.4.4.6 T15 Trigger Mode

Description: Select the trigger mode for the digital input.

Default Value: 0 [None]	Parameter Type: Selection	Parameter Number: 2044
Unit: -	Data Type: UINT	Access Type: Read/Write

The following are the selections for the parameter.

Selection Number	Selection Name	Selection Description
0	None	No event trigger.
1	Rising Edge	Trigger an event at the rising edge.
2	Falling Edge	Trigger an event at the falling edge.
3	Both Edges	Trigger an event at both the rising and falling edges.

P 9.4.4.7 T15 Pulse Min. Frequency

Description: Set the frequency representing 0% of the signal.

Default Value:	Parameter Type: Range (0 — 110000)	Parameter Number: 2045
Unit: Hz	Data Type: REAL	Access Type: Read/Write

P 9.4.4.8 T15 Pulse Max. Frequency

Description: Set the frequency representing 100% of the signal.

Default Value: 110000	Parameter Type: Range (0 — 110000)	Parameter Number: 2046
Unit: Hz	Data Type: REAL	Access Type: Read/Write

P 9.4.4.9 T15 Digital Output Logic

Description: Select the operating logic for the digital output.

Default Value: 0 [Tri state]	Parameter Type: Selection	Parameter Number: 2047
Unit: -	Data Type: UINT	Access Type: Read/Write

The following are the selections for the parameter.

Selection Number	Selection Name	Selection Description
0	Tri state	Disable output (high impedance).
1	Open collector sink (NPN)	Open collector sink (NPN).
2	Open collector source (PNP)	Open collector source (PNP).
3	Push pull	Terminal can both sink and source.

P 9.4.4.10 T15 Pulse Out Min. Frequency

Description: Set the frequency representing 0% of the signal.

Default Value:	Parameter Type: Range (0 — 100000)	Parameter Number: 2048
Unit: Hz	Data Type: REAL	Access Type: Read/Write

P 9.4.4.11 T15 Pulse Out Max. Frequency

Description: Set the frequency representing 100% of the signal.

Default Value: 100000	Parameter Type: Range (0 — 100000)	Parameter Number: 2049
Unit: Hz	Data Type: REAL	Access Type: Read/Write

6.10.2.2.6 Input/Output T16 (Menu Index 9.4.5)

P 9.4.5.1 T16 Terminal Mode

Description: Select the mode for the terminal.

Default Value: 3 [Digital input]	Parameter Type: Selection	Parameter Number: 2298
Unit: -	Data Type: UINT	Access Type: Read/Write

The following are the selections for the parameter.

Selection Number	Selection Name	Selection Description
0	Inactive	
1	Digital Output	Configures the terminal as boolean output true/false.
2	Pulse Output	Configures the terminal as analog output based on pulse frequency.
3	Digital input	The terminal is configured as boolean input (true/false).
4	Pulse input	The terminal is configured as pulse input. The frequency represents an analog value.

P 9.4.5.2 T16 Signal Inversion

Description: Select whether the signal of the terminal is inverted.

Default Value: 0 [Non-Inverted]	Parameter Type: Selection	Parameter Number: 2296
Unit: -	Data Type: UINT	Access Type: Read/Write

The following are the selections for the parameter.

Selection Number	Selection Name	Selection Description
0	Non-Inverted	The signal is not inverted.
1	Inverted	The signal is logically inverted.

P 9.4.5.3 T16 Fast Debounce Filtering Time

Description: Set the fast debounce filtering time for the terminal.

Default Value:	Parameter Type: Range (0.00 — 63.50)	Parameter Number: 2290
Unit: μ s	Data Type: REAL	Access Type: Read/Write

P 9.4.5.4 T16 Standard Debounce Filtering Time

Description: Set the standard debounce filtering time for the terminal.

Default Value: 5.00	Parameter Type: Range (0.00 — 127.00)	Parameter Number: 2260
Unit: ms	Data Type: REAL	Access Type: Read/Write

P 9.4.5.5 T16 Reaction Time

Description: Select the reaction time for the debounce filter.

Default Value: 0 [Standard reaction time (1ms tick)]	Parameter Type: Selection	Parameter Number: 2052
Unit: -	Data Type: UINT	Access Type: Read/Write

The following are the selections for the parameter.

Selection Number	Selection Name	Selection Description
0	Standard reaction time (1ms tick)	Use the digital input in the same way as other inputs.
1	Fast reaction time (0.5 μ s tick)	Enables a fast reaction time for a certain event via digital input.

P 9.4.5.6 T16 Trigger Mode

Description: Select the trigger mode for the digital input.

Default Value: 0 [None]	Parameter Type: Selection	Parameter Number: 2053
Unit: -	Data Type: UINT	Access Type: Read/Write

The following are the selections for the parameter.

Selection Number	Selection Name	Selection Description
0	None	No event trigger.
1	Rising Edge	Trigger an event at the rising edge.
2	Falling Edge	Trigger an event at the falling edge.
3	Both Edges	Trigger an event at both the rising and falling edges.

P 9.4.5.7 T16 Pulse Min. Frequency

Description: Set the frequency representing 0% of the signal.

Default Value:	Parameter Type: Range (0 — 110000)	Parameter Number: 2054
Unit: Hz	Data Type: REAL	Access Type: Read/Write

P 9.4.5.8 T16 Pulse Max. Frequency

Description: Set the frequency representing 100% of the signal.

Default Value: 110000	Parameter Type: Range (0 — 110000)	Parameter Number: 2055
Unit: Hz	Data Type: REAL	Access Type: Read/Write

P 9.4.5.9 T16 Digital Output Type

Description: Select the operating logic for the digital output.

Default Value: 0 [Tri state]	Parameter Type: Selection	Parameter Number: 2056
Unit: -	Data Type: UINT	Access Type: Read/Write

The following are the selections for the parameter.

Selection Number	Selection Name	Selection Description
0	Tri state	Disable output (high impedance).
1	Open collector sink (NPN)	Open collector sink (NPN).
2	Open collector source (PNP)	Open collector source (PNP).
3	Push pull	Terminal can both sink and source.

P 9.4.5.10 T16 Pulse Out Min. Frequency

Description: Set the frequency representing 0% of the signal.

Default Value:	Parameter Type: Range (0 — 100000)	Parameter Number: 2051
Unit: Hz	Data Type: REAL	Access Type: Read/Write

P 9.4.5.11 T16 Pulse Out Max. Frequency

Description: Set the frequency representing 100% of the signal.

Default Value: 100000	Parameter Type: Range (0 — 100000)	Parameter Number: 2050
Unit: Hz	Data Type: REAL	Access Type: Read/Write

6.10.2.2.7 Input T17 (Menu Index 9.4.6)

P 9.4.6.1 T17 Terminal Mode

Description: Select the mode for the terminal.

Default Value: 3 [Digital input]	Parameter Type: Selection	Parameter Number: 2017
Unit: -	Data Type: UINT	Access Type: Read/Write

The following are the selections for the parameter.

Selection Number	Selection Name	Selection Description
0	Inactive	
3	Digital input	The terminal is configured as boolean input (true/false).
4	Pulse input	The terminal is configured as pulse input. The frequency represents an analog value.

P 9.4.6.2 T17 Signal Inversion

Description: Select whether the signal of the terminal is inverted.

Default Value: 0 [Non-Inverted]	Parameter Type: Selection	Parameter Number: 2293
Unit: -	Data Type: UINT	Access Type: Read/Write

The following are the selections for the parameter.

Selection Number	Selection Name	Selection Description
0	Non-Inverted	The signal is not inverted.
1	Inverted	The signal is logically inverted.

P 9.4.6.3 T17 Fast Debounce Filtering Time

Description: Set the fast debounce filtering time for the terminal.

Default Value:	Parameter Type: Range (0.00 — 63.50)	Parameter Number: 2287
Unit: μ s	Data Type: REAL	Access Type: Read/Write

P 9.4.6.4 T17 Standard Debounce Filtering Time

Description: Set the standard debounce filtering time for the terminal.

Default Value: 5.00	Parameter Type: Range (0.00 — 127.00)	Parameter Number: 2034
Unit: ms	Data Type: REAL	Access Type: Read/Write

P 9.4.6.5 T17 Reaction Time

Description: Select the reaction time for the debounce filter.

Default Value: 0 [Standard reaction time (1ms tick)]	Parameter Type: Selection	Parameter Number: 2035
Unit: -	Data Type: UINT	Access Type: Read/Write

The following are the selections for the parameter.

Selection Number	Selection Name	Selection Description
0	Standard reaction time (1ms tick)	Use the digital input in the same way as other inputs.
1	Fast reaction time (0.5 μ s tick)	Enables a fast reaction time for a certain event via digital input.

P 9.4.6.6 T17 Trigger Mode

Description: Select the trigger mode for the digital input.

Default Value: 0 [None]	Parameter Type: Selection	Parameter Number: 2036
Unit: -	Data Type: UINT	Access Type: Read/Write

The following are the selections for the parameter.

Selection Number	Selection Name	Selection Description
0	None	No event trigger.
1	Rising Edge	Trigger an event at the rising edge.

Selection Number	Selection Name	Selection Description
2	Falling Edge	Trigger an event at the falling edge.
3	Both Edges	Trigger an event at both the rising and falling edges.

P 9.4.6.7 T17 Pulse Min. Frequency

Description: Set the frequency representing 0% of the signal.

Default Value:	Parameter Type: Range (0 — 110000)	Parameter Number: 2037
Unit: Hz	Data Type: REAL	Access Type: Read/Write

P 9.4.6.8 T17 Pulse Max. Frequency

Description: Set the frequency representing 100% of the signal.

Default Value: 110000	Parameter Type: Range (0 — 110000)	Parameter Number: 2038
Unit: Hz	Data Type: REAL	Access Type: Read/Write

6.10.2.2.8 Input T18 (Menu Index 9.4.7)

P 9.4.7.1 T18 Terminal Mode

Description: Select the mode for the terminal.

Default Value: 3 [Digital input]	Parameter Type: Selection	Parameter Number: 2018
Unit: -	Data Type: UINT	Access Type: Read/Write

The following are the selections for the parameter.

Selection Number	Selection Name	Selection Description
0	Inactive	
3	Digital input	The terminal is configured as boolean input (true/false).
4	Pulse input	The terminal is configured as pulse input. The frequency represents an analog value.

P 9.4.7.2 T18 Signal Inversion

Description: Select whether the signal of the terminal is inverted.

Default Value: 0 [Non-Inverted]	Parameter Type: Selection	Parameter Number: 2294
Unit: -	Data Type: UINT	Access Type: Read/Write

The following are the selections for the parameter.

Selection Number	Selection Name	Selection Description
0	Non-Inverted	The signal is not inverted.
1	Inverted	The signal is logically inverted.

P 9.4.7.3 T18 Fast Debounce Filtering Time

Description: Set the fast debounce filtering time for the terminal.

Default Value:	Parameter Type: Range (0.00 — 63.50)	Parameter Number: 2288
Unit: μ s	Data Type: REAL	Access Type: Read/Write

P 9.4.7.4 T18 Standard Debounce Filtering Time

Description: Set the standard debounce filtering time for the terminal.

Default Value: 5.00	Parameter Type: Range (0.00 — 127.00)	Parameter Number: 2039
Unit: ms	Data Type: REAL	Access Type: Read/Write

P 9.4.7.5 T18 Reaction Time

Description: Select the reaction time for the debounce filter.

Default Value: 0 [Standard reaction time (1ms tick)]	Parameter Type: Selection	Parameter Number: 2040
Unit: -	Data Type: UINT	Access Type: Read/Write

The following are the selections for the parameter.

Selection Number	Selection Name	Selection Description
0	Standard reaction time (1ms tick)	Use the digital input in the same way as other inputs.
1	Fast reaction time (0.5 μ s tick)	Enables a fast reaction time for a certain event via digital input.

P 9.4.7.6 T18 Trigger Mode

Description: Select the trigger mode for the digital input.

Default Value: 0 [None]	Parameter Type: Selection	Parameter Number: 2041
Unit: -	Data Type: UINT	Access Type: Read/Write

The following are the selections for the parameter.

Selection Number	Selection Name	Selection Description
0	None	No event trigger.
1	Rising Edge	Trigger an event at the rising edge.

Selection Number	Selection Name	Selection Description
2	Falling Edge	Trigger an event at the falling edge.
3	Both Edges	Trigger an event at both the rising and falling edges.

P 9.4.7.7 T18 Pulse Min. Frequency

Description: Set the frequency representing 0% of the signal.

Default Value:	Parameter Type: Range (0 — 110000)	Parameter Number: 2042
Unit: Hz	Data Type: REAL	Access Type: Read/Write

P 9.4.7.8 T18 Pulse Max. Frequency

Description: Set the frequency representing 100% of the signal.

Default Value: 110000	Parameter Type: Range (0 — 110000)	Parameter Number: 2043
Unit: Hz	Data Type: REAL	Access Type: Read/Write

6.10.2.3 Analog Inputs/Outputs (Menu Index 9.5)

6.10.2.3.1 Output T31 (Menu Index 9.5.1)

P 9.5.1.1 T31 Terminal Mode

Description: Select the mode for the terminal.

Default Value: 5 [Analog Output]	Parameter Type: Selection	Parameter Number: 2019
Unit: -	Data Type: UINT	Access Type: Read/Write

The following are the selections for the parameter.

Selection Number	Selection Name	Selection Description
0	Inactive	
5	Analog Output	Configures the terminal as an analog output.

P 9.5.1.2 T31 Terminal Type

Description: Select the type of the terminal. If voltage is selected, the unit is V. If current is selected, the unit is mA.

Default Value: 0 [Off]	Parameter Type: Selection	Parameter Number: 2284
Unit: -	Data Type: UINT	Access Type: Read/Write

The following are the selections for the parameter.

Selection Number	Selection Name	Selection Description
0	Off	
1	Voltage	Terminal set to voltage mode.
2	Current	Terminal set to current mode.

P 9.5.1.3 T31 Minimum Value

Description: Set the voltage or current representing 0% of the signal.

Default Value:	Parameter Type: Range (0 — 20)	Parameter Number: 2283
Unit: -	Data Type: REAL	Access Type: Read/Write

P 9.5.1.4 T31 Maximum Value

Description: Set the voltage or current representing 100% of the signal.

Default Value: 10	Parameter Type: Range (0 — 20)	Parameter Number: 2282
Unit: -	Data Type: REAL	Access Type: Read/Write

6.10.2.3.2 Input T33 (Menu Index 9.5.2)

P 9.5.2.1 T33 Terminal Mode

Description: Select the mode for the terminal.

Default Value: 6 [Analog Input]	Parameter Type: Selection	Parameter Number: 2020
Unit: -	Data Type: UINT	Access Type: Read/Write

The following are the selections for the parameter.

Selection Number	Selection Name	Selection Description
0	Inactive	
6	Analog Input	Configures the terminal as analog input.

P 9.5.2.2 T33 Terminal Type

Description: Select the type of the terminal. If voltage is selected, the unit is V. If current is selected, the unit is mA.

Default Value: 1 [Voltage]	Parameter Type: Selection	Parameter Number: 2273
Unit: -	Data Type: UINT	Access Type: Read/Write

The following are the selections for the parameter.

Selection Number	Selection Name	Selection Description
1	Voltage	Terminal set to voltage mode.
2	Current	Terminal set to current mode.

P 9.5.2.3 T33 Minimum Value

Description: Set the voltage or current representing 0% of the signal.

Default Value:	Parameter Type: Range (-20 — 20)	Parameter Number: 2272
Unit: -	Data Type: REAL	Access Type: Read/Write

P 9.5.2.4 T33 Maximum Value

Description: Set the voltage or current representing 100% of the signal.

Default Value: 10	Parameter Type: Range (-20 — 20)	Parameter Number: 2271
Unit: -	Data Type: REAL	Access Type: Read/Write

P 9.5.2.5 T33 Filter Time

Description: Set the filter time for the terminal.

Default Value:	Parameter Type: Range (0.00 — 60000.00)	Parameter Number: 2270
Unit: ms	Data Type: REAL	Access Type: Read/Write

P 9.5.2.6 T33 Live Zero Threshold Value

Description: Set the live zero threshold value for the terminal. The response to a live zero event is defined with parameter "5.2.15.2 Live Zero Response".

Default Value: -10	Parameter Type: Range (-20 — 20)	Parameter Number: 2274
Unit: -	Data Type: REAL	Access Type: Read/Write

P 9.5.2.7 T33 Live Zero Timeout Value

Description: Set the live zero timeout value for the terminal. The response to a live zero event is defined with parameter "5.2.15.2 Live Zero Response".

Default Value:	Parameter Type: Range (0 — 60)	Parameter Number: 2275
Unit: s	Data Type: REAL	Access Type: Read/Write

6.10.2.3.3 Input T34 (Menu Index 9.5.3)

P 9.5.3.1 T34 Terminal Mode

Description: Select the mode for the terminal.

Default Value: 6 [Analog Input]	Parameter Type: Selection	Parameter Number: 2021
Unit: -	Data Type: UINT	Access Type: Read/Write

The following are the selections for the parameter.

Selection Number	Selection Name	Selection Description
0	Inactive	
6	Analog Input	Configures the terminal as analog input.
7	Temperature input	Configures the terminal as temperature sensor input.

P 9.5.3.2 T34 Terminal Type

Description: Select the type of the terminal. If voltage is selected, the unit is V. If current is selected, the unit is mA.

Default Value: 1 [Voltage]	Parameter Type: Selection	Parameter Number: 2279
Unit: -	Data Type: UINT	Access Type: Read/Write

The following are the selections for the parameter.

Selection Number	Selection Name	Selection Description
1	Voltage	Terminal set to voltage mode.
2	Current	Terminal set to current mode.

P 9.5.3.3 T34 Minimum Value

Description: Set the voltage or current representing 0% of the signal.

Default Value:	Parameter Type: Range (-20 — 20)	Parameter Number: 2278
Unit: -	Data Type: REAL	Access Type: Read/Write

P 9.5.3.4 T34 Maximum Value

Description: Set the voltage or current representing 100% of the signal.

Default Value: 10	Parameter Type: Range (-20 — 20)	Parameter Number: 2277
Unit: -	Data Type: REAL	Access Type: Read/Write

P 9.5.3.5 T34 Filter Time

Description: Set the filter time for the terminal.

Default Value:	Parameter Type: Range (0.00 — 60000.00)	Parameter Number: 2276
Unit: ms	Data Type: REAL	Access Type: Read/Write

P 9.5.3.6 T34 Live Zero Threshold Value

Description: Set the live zero threshold value for the terminal. The response to a live zero event is defined with parameter "5.2.15.2 Live Zero Response".

Default Value: -10	Parameter Type: Range (-20 — 20)	Parameter Number: 2280
Unit: -	Data Type: REAL	Access Type: Read/Write

P 9.5.3.7 T34 Live Zero Timeout Value

Description: Set the live zero timeout value for the terminal. The response to a live zero event is defined with parameter "5.2.15.2 Live Zero Response".

Default Value:	Parameter Type: Range (0 — 60)	Parameter Number: 2281
Unit: s	Data Type: REAL	Access Type: Read/Write

P 9.5.3.8 T34 Temperature Sensor Type

Description: Select which type of temperature sensor is connected to the terminal.

Default Value: 0 [No sensor]	Parameter Type: Selection	Parameter Number: 1617
Unit: -	Data Type: UINT	Access Type: Read/Write

The following are the selections for the parameter.

Selection Number	Selection Name	Selection Description
0	No sensor	No sensor selected.
4	Pt1000	Pt1000 temperature sensor connected.
5	Ni1000Tk5000	Ni1000Tk5000 temperature sensor connected.
6	Ni1000Tk6180	Ni1000Tk6180 temperature sensor connected.
7	KTY84-1x0	KTY84-1x0 temperature sensor connected.
8	KTY84-151	KTY84-151 temperature sensor connected.
9	KTY84-152	KTY84-152 temperature sensor connected.
10	KTY81/82-1x0	KTY81/82-1x0 temperature sensor connected.
11	KTY81/82-121	KTY81/82-121 temperature sensor connected.
12	KTY81/82-122	KTY81/82-122 temperature sensor connected.
13	KTY81/82-151	KTY81/82-151 temperature sensor connected.
14	KTY81/82-152	KTY81/82-152 temperature sensor connected.
15	KTY81/82-2x0	KTY81/82-2x0 temperature sensor connected.
16	KTY81/82-221	KTY81/82-221 temperature sensor connected.

Selection Number	Selection Name	Selection Description
17	KTY81/82-222	KTY81/82-222 temperature sensor connected.
18	KTY81/82-251	KTY81/82-251 temperature sensor connected.
19	KTY81/82-252	KTY81/82-252 temperature sensor connected.

6.11 Connectivity (Menu Index 10)

6.11.1 Connectivity Overview

This section provides information about configuring and monitoring all types of communication interfaces as well as the communication and fieldbus protocols available. Following are the available interfaces:

- Communication interface X0
- Communication interface X1/X2

The following are the available network management protocol and fieldbus protocols:

- SNMP
- PROFINET
- MODBUS TCP
- EtherNet/IP
- EtherCAT
- OPC UA

For more information, refer to the related fieldbus guide.

6.11.2 Communication interfaces (Menu Index 10.2)

6.11.2.1 Host Settings (Menu Index 10.2.1)

P 10.2.1.1 Fully Qualified Domain Name

Fully Qualified Domain Name. Consists of a host name label and at least 1 higher-level domain separated by the symbol "." with up to 240 characters in total. Each label contains upto 63 characters and starts with a lowercase letter and ends with alphanumeric lowercase character and have as interior characters only alphanumeric lowercase characters and '-'.
 Note: The host name label must be at least 1 character long.

Default Value:	*	Parameter Type:	Range (* — *)
Parameter Number:	7036	Unit:	–
Data Type:	STRING	Access Type:	Read/Write

6.11.2.2 Ethernet Interface X0 (Menu Index 10.2.2)

S 10.2.2.1 IPv4 Settings

This menu enables IP configuration of the interface.

S 10.2.2.2 IPv4 Status

This menu contains information about the IP configuration of the interface.

6.11.2.2.1 Interface X0 IPv4 Settings

The Ethernet Interface X0 IPv4 settings view contains the following fields:

- Interface X0 MAC address
- IPv4 addressing method
- Requested IPv4 address
- Requested IPv4 SUBNET mask
- Requested IPv4 gateway address
- Enable ACD
- DNS server 1
- DNS server 2

6.11.2.2.2 Interface X0 IPv4 Status

The Ethernet Interface X0 IPv4 status view contains the following fields:

- Interface X0 MAC address
- IPv4 addressing method
- Actual IPv4 address
- Actual IPv4 SUBNET mask
- Actual IPv4 gateway address
- DHCP server
- Actual DNS server 1
- Actual DNS server 2
- ACD activity

6.11.2.3 Ethernet Interface X1/X2 Settings (Menu Index 10.2.3)

S 10.2.3.1 IPv4 Settings

This menu enables IP configuration of the interface.

S 10.2.3.2 IPv4 Status

This menu contains information about the IP configuration of the interface.

6.11.2.3.1 Interface X1/X2 IPv4 Settings

The Ethernet Interface X1/X2 IPv4 settings view contains the following fields:

- Interface X1 MAC address
- IPv4 addressing method
- Requested IPv4 address
- Requested IPv4 SUBNET mask
- Requested IPv4 gateway address
- Enable ACD
- DNS server 1
- DNS server 2

6.11.2.3.2 Interface X1/X2 IPv4 Status

The Ethernet Interface X1/X2 IPv4 status view contains the following fields:

- Interface X1 MAC address
- IPv4 addressing method
- Actual IPv4 address
- Actual IPv4 SUBNET mask
- Actual IPv4 gateway address
- DHCP server
- Actual DNS server 1
- Actual DNS server 2
- ACD activity

6.11.2.4 Ethernet port X0 (Menu Index 10.2.4)

6.11.2.4.1 X0 Settings (Menu Index 10.2.4.2)

P 10.2.4.2.5 Link configuration X0

Select the configuration of the Ethernet link parameters.

Default Value:	0 (Auto negotiation)	Parameter Type:	Selection
Parameter Number:	7047	Unit:	–
Data Type:	USINT	Access Type:	Read/Write

The following are the selections for the parameter.

Selection Number	Selection Name	Selection Description
0	Auto negotiation	The drive handles the speed and duplex settings.
1	10 Mbps full duplex	10 Mbps with full duplex.
2	10 Mbps half duplex	10 Mbps with half duplex.
3	100 Mbps full duplex	100 Mbps with full duplex.
4	100 Mbps half duplex	100 Mbps with half duplex.

6.11.2.5 Ethernet port X1 (Menu Index 10.2.5)

6.11.2.5.1 X1 Settings (Menu Index 10.2.5.2)

P 10.2.5.2.5 Link Configuration X1

Select the configuration of the Ethernet link parameters.

Default Value:	0 (Auto negotiation)	Parameter Type:	Selection
Parameter Number:	7048	Unit:	–
Data Type:	USINT	Access Type:	Read/Write

The following are the selections for the parameter.

Selection Number	Selection Name	Selection Description
0	Auto negotiation	The drive handles the speed and duplex settings.
1	10 Mbps full duplex	10 Mbps with full duplex.
2	10 Mbps half duplex	10 Mbps with half duplex.
3	100 Mbps full duplex	100 Mbps with full duplex.
4	100 Mbps half duplex	100 Mbps with half duplex.

6.11.2.6 Ethernet port X2 (Menu Index 10.2.6)

6.11.2.6.1 X2 Settings (Menu Index 10.2.6.2)

P 10.2.6.2.5 Link Configuration X2

Select the configuration of the Ethernet link parameters.

Default Value:	0 (Auto negotiation)	Parameter Type:	Selection
Parameter Number:	7049	Unit:	–
Data Type:	USINT	Access Type:	Read/Write

The following are the selections for the parameter.

Selection Number	Selection Name	Selection Description
0	Auto negotiation	The drive handles the speed and duplex settings.
1	10 Mbps full duplex	10 Mbps with full duplex.
2	10 Mbps half duplex	10 Mbps with half duplex.
3	100 Mbps full duplex	100 Mbps with full duplex.
4	100 Mbps half duplex	100 Mbps with half duplex.

6.11.2.7 Port Mirroring (Menu Index 10.2.7)

S 10.2.7 Port Mirroring

Enable/disable the port-mirroring function for network troubleshooting with a network analyzer tool.

6.11.3 Protocols (Menu Index 10.3)

6.11.3.1 General Settings (Menu Index 10.3.1)

P 10.3.1.2 Fieldbus Profile

Select the fieldbus profile. The selection affects the interpretation of the control word and status word.

Default Value:	101 (iC Speed Profile)	Parameter Type:	Selection
Parameter Number:	1301	Unit:	–
Data Type:	UINT	Access Type:	Read/Write

The following are the selections for the parameter.

Selection Number	Selection Name	Selection Description
101	iC Speed Profile	The fieldbus control word and status word are interpreted according the iC Speed Profile definition.
201	PROFIdrive Standard Telegram 1	The fieldbus control word and status word are interpreted according to the PROFIdrive Standard Telegram 1 standard.
302	CiA402 Velocity Mode	The fieldbus control word and status word are interpreted according to the CiA402 Velocity Mode standard.

P 10.3.1.3 Fieldbus Fault Response

Select the behavior when a fieldbus fault occurs.

Default Value:	1 (Info)	Parameter Type:	Selection
Parameter Number:	1303	Unit:	–
Data Type:	UINT	Access Type:	Read/Write

The following are the selections for the parameter.

Selection Number	Selection Name	Selection Description
1	Info	The event is logged in the event log.
3	Warning	The drive issues a warning.
9	Fault, ramp to coast	Issues a fault, ramps down, and coast.
10	Fault	The drive issues a fault and coasts the motor.

P 10.3.1.4 No Fieldbus Connection Response

Select the response in case there is no fieldbus connection.

Default Value:	1 (Info)	Parameter Type:	Selection
Parameter Number:	1327	Unit:	–
Data Type:	UINT	Access Type:	Read/Write

The following are the selections for the parameter.

Selection Number	Selection Name	Selection Description
1	Info	The event is logged in the event log.
3	Warning	The drive issues a warning.
9	Fault, ramp to coast	Issues a fault, ramps down, and coast.
10	Fault	The drive issues a fault and coasts the motor.

P 10.3.1.6 Process Data Timeout Time

Set the timeout time. If process data is not received within the time set, a process data timeout is triggered.

Default Value:	1	Parameter Type:	Range (0 — 18000)
Parameter Number:	1340	Unit:	s

Data Type:	REAL	Access Type:	Read/Write
-------------------	------	---------------------	------------

P 10.3.1.12 Process Data Timeout Response

Select the response to a process data timeout.

Default Value:	10 (Fault)	Parameter Type:	Selection
Parameter Number:	1341	Unit:	–
Data Type:	UINT	Access Type:	Read/Write

The following are the selections for the parameter.

Selection Number	Selection Name	Selection Description
1	Info	The event is logged in the event log.
3	Warning	The drive issues a warning.
5	Warning - Change Control Place	The drive issues a warning, and the control place changes to the selected alternative while the timeout warning is active. The control place will change back to the original one when the fieldbus process data returns.
6	Warning - Change Control Place - Persistent	The drive issues a warning, and the control place changes to the selected alternative while the timeout warning is active. The control place requires a reset command to change back to the original one after the fieldbus process data returns.
9	Fault, ramp to coast	Issues a fault, ramps down, and coast.
10	Fault	The drive issues a fault and coasts the motor.

P 10.3.1.13 Process Data Timeout Control Place

Select the alternative control place to be used in case of fieldbus timeout. This is only valid in case of timeout warning or info.

Default Value:	1 (Local control)	Parameter Type:	Selection
Parameter Number:	112	Unit:	–
Data Type:	UINT	Access Type:	Read/Write

The following are the selections for the parameter.

Selection Number	Selection Name	Selection Description
1	Local control	The drive is controlled by a connected control panel.
2	Fieldbus control	The drive is controlled via a fieldbus.
3	I/O control	The drive is controlled via I/O.
4	Advanced control	The drive is controlled via a combination of I/O and fieldbus.

6.11.3.2 PROFINET (Menu Index 10.3.2)

6.11.3.2.1 Status (Menu Index 10.3.2.1)

S 10.3.2.1.1 PROFINET Report

6.11.3.2.2 Configuration (Menu Index 10.3.2.2)

P 10.3.2.2.1 Name of Station

Set the name of station. The PROFINET device is identified by its name of station. Each name must be unique in the network.

Default Value:	–	Parameter Type:	Range (* — *)
Parameter Number:	7080	Unit:	–
Data Type:	STRING	Access Type:	Read/Write

6.11.3.2.3 Diagnosis (Menu Index 10.3.2.3)

P 10.3.2.3.1 Diagnostic Fault

Enables diagnostic fault. When disabled the device will not send any PROFINET diagnosis message with severity "Fault" when a fault is present on device.

Default Value:	1 (Enabled)	Parameter Type:	Selection
Parameter Number:	7081	Unit:	–
Data Type:	BOOL	Access Type:	Read/Write

The following are the selections for the parameter.

Selection Number	Selection Name	Selection Description
0	Disabled	Disables the function.
1	Enabled	Enables the function.

P 10.3.2.3.2 Diagnostic Warning

Enables diagnostic warning. When disabled the device will not send any PROFINET diagnosis message with severity "Maintenance required" when a warning is present on device.

Default Value:	1 (Enabled)	Parameter Type:	Selection
Parameter Number:	7083	Unit:	–
Data Type:	BOOL	Access Type:	Read/Write

The following are the selections for the parameter.

Selection Number	Selection Name	Selection Description
0	Disabled	Disables the function.
1	Enabled	Enables the function.

6.11.3.3 Modbus (Menu Index 10.3.3)

6.11.3.3.1 Configuration (Menu Index 10.3.3.2)

P 10.3.3.2.1 Persistent Storage

Select if persistent storage is active for Modbus writes.

Default Value:	0 (Disabled)	Parameter Type:	Selection
Parameter Number:	7061	Unit:	–
Data Type:	BOOL	Access Type:	Read/Write

The following are the selections for the parameter.

Selection Number	Selection Name	Selection Description
0	Disabled	Modbus writings are not written to persistent storage.
1	Enabled	Modbus writings are written to persistent storage.

P 10.3.3.2.3 Byte Order

Select the byte order.

Default Value:	0 (Big Endian)	Parameter Type:	Selection
Parameter Number:	7062	Unit:	–
Data Type:	USINT	Access Type:	Read/Write

The following are the selections for the parameter.

Selection Number	Selection Name	Selection Description
0	Big Endian	Byte order is defined as big-endian - The most significant value to the left.
1	Little Endian	Byte order is defined as little-endian - The least significant value to the left.

P 10.3.3.2.4 Word Order

Select the word order.

Default Value:	1 (Little Endian)	Parameter Type:	Selection
Parameter Number:	7063	Unit:	–
Data Type:	USINT	Access Type:	Read/Write

The following are the selections for the parameter.

Selection Number	Selection Name	Selection Description
0	Big Endian	Byte order is defined as big-endian - The most significant value to the left.
1	Little Endian	Byte order is defined as little-endian - The least significant value to the left.

6.11.3.4 EtherNet/IP (Menu Index 10.3.4)

6.11.3.4.1 Status (Menu Index 10.3.4.1)

S 10.3.4.1.1 EtherNet/IP Report

6.11.3.5 EtherCAT (Menu Index 10.3.5)

6.11.3.5.1 Configuration (Menu Index 10.3.5.2)

P 10.3.5.2.1 Device ID

The EtherCAT Explicit Device Identification is an optional feature for identifying an EtherCAT slave explicitly. If set, the value must be unique within a network configuration.

Default Value:	0	Parameter Type:	Range (0 — 65535)
Parameter Number:	7084	Unit:	–
Data Type:	UINT	Access Type:	Read/Write

6.11.3.6 OPC UA (Menu Index 10.3.6)

6.11.3.6.1 Configuration (Menu Index 10.3.6.2)

P 10.3.6.2.1 Interface Selection

Select Interface for OPC UA.

Default Value:	1 (X0)	Parameter Type:	Selection
Parameter Number:	7086	Unit:	–
Data Type:	USINT	Access Type:	Read/Write

The following are the selections for the parameter.

Selection Number	Selection Name	Selection Description
0	None	No Interface for OPC UA.
1	X0	X0 Interface for OPC UA.
2	X1/X2	X1/X2 Interface for OPC UA.

P 10.3.6.2.2 Reverse Connect URL

Set OPC UA reverse connection URL. Clear to remove the reverse connection.

Default Value:	–	Parameter Type:	Range (* — *)
Parameter Number:	7085	Unit:	–
Data Type:	STRING	Access Type:	Read/Write

7 Troubleshooting

7.1 Viewing Warnings

When a warning event occurs, the status indicators (halo and WARN) turn yellow. The drive remains operational and when the trigger for the warning is corrected, the indicators turn white.

To view the details of a warning, go to parameter group **6.4.1 Active Events**.

To view the history of events for the drive, go to parameter group **6.4.2 Event History**.

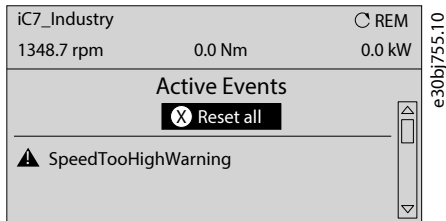

Figure 86: Warnings

7.2 Viewing and Resetting Faults

When a fault occurs in the drive, the status indicators halo and FAULT turn red. The control panel display shows the name of the fault, and allows a direct reset.

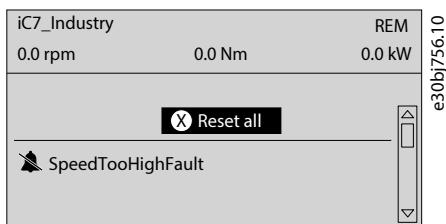

Figure 87: Fault on the Control Panel

1. To view details about a fault and its cause, select the fault in the list shown on the control panel and press **[OK]**.

If the control panel display has changed, simultaneously press the left and right arrows on the control panel to return to parameter group **6.4.1 Active Events**.

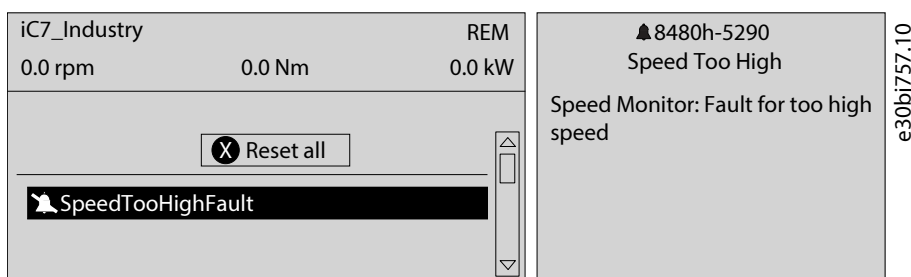

Figure 88: View Active Faults

2. Resolve all triggers causing the fault.
3. Select *Reset all* and press **[OK]**.

7.3 Reading the Event Summary Table

Group number and number (columns 1–2)

Events in iC7 drives have 2 different identifiers: Group numbers and Individual numbers.

The group numbers for iC7 drives follow the DRIVECOM industry standard error code specification. The specification originated with the Interbus communication profile. The [Interbus V3.0 base profile](#) was released on 2018-04-19. The [inverter specific profile](#) was released on 1997-12-15. The error code specification was adopted by CAN in Automation and ODVA and is used within their respective Drive Profile. The list of standardized error codes can be found within [IEC 61800-7-201](#).

Unlike individual numbers, the group numbers are not unique since multiple errors can be related to each other. An example is different ground faults which share the Group Number 0x2330.

Display name and description (columns 3–4)

The columns are showing the name and a short description of the event. A few display names are marked with a * which indicates that the event can be configured via a parameter.

Type of event (columns 5–8)

The event summary table shows column names where I – Info, W – Warning, F – Fault, and PF – Protected Fault.

- **Info:** The notification provides information to the user.
- **Warning:** The notification informs that an undesired event is happening. The drive can continue operation, but it might be with reduced performance and/or the drive might trip.
- **Fault (Trip):** An error notification informs that an undesired high-severity event occurred. The motor coasts without control from the drive. The error message and the error can be reset without power cycling the drive.
- **Protected Fault (Trip Lock):** An error notification informs that an undesired high-severity event happened. The motor coasts without control from the drive. The error message and the error can be reset after power cycling the drive.

Action of the inverter and brake chopper (columns 9–10)

The columns show the possible action of the inverter (output of the drive) and the brake chopper, where C = Coast and RC = Ramp to Coast.

- **Inverter:**
 - RC: Output ramps to 0 before coasting.
 - C: Output coasts immediately.
- **Brake chopper:**
 - C: Output of the brake coasts immediately.

7.4 Events Summary for Industry Application Software

The following table lists the events that can occur in the Industry application software.

Table 56: Summary Table

Group Number (Hex)	Number (Decimal)	Display Name	Description	Type of Event				Inverter and Brake Chopper Action	
				I	W	F	PF	Inverter	Brake
0x20FF	4372	Current Injection Limit	The time limit for the short term current injection is exceeded.		X	X		C	
0x2110	4379	CM Current High	An excessive common mode current is detected in the LCL-filter.		X	X		C	
0x2212	4374	DC-link Resonance	A resonance on the DC link with excessive RMS current values is detected.		X	X		C	
0x2221	4384	Thermal Overload Rectifier	The rectifier is thermally overloaded. Mission profile is too demanding.		X	X		C	
0x2222	4373	DC-link Overcurrent	An overcurrent on the main DC-link capacitors is detected.		X	X		C	
0x2310	5170	Current Limit Timeout	The drive has exceeded the allowed time in current limit.			X		C	
0x2311	4097	Inverter Overload	Thermal overload is detected in the inverter of the drive. Reduce the output load.		X	X		C	
0x2311	4368	Output Current High 0	The output current of the drive has exceeded its normal range at low speed. Shock load or too fast acceleration with high-inertia loads can cause this fault. Check that the motor size matches the drive and the motor data is correct. Check that the motor shaft can be turned.		X	X		C	
0x2311	4369	Output Current High 1	The output current of the drive has exceeded its normal range. Shock load or too fast acceleration with high-inertia loads can cause this fault. Check that the motor size matches the drive and the motor data is correct. Check that the motor shaft can be turned.		X	X		C	
0x2311	4375	Excessive Current Limiting	The output current of the drive has exceeded the current limit multiple times. Check that the motor size matches the drive and the motor data is correct. Check that the motor shaft can be turned.		X	X		C	
0x2311	4377	Smart Derating Fault	A Smart Derating fault is detected. The load is too demanding for the current derating level. Lower the switching frequency if possible.		X	X		C	
0x2311	4380	Current Limit Setting Fault	The actual current limit setting is too high relative to the selected constant control frequency level. Reduce the control frequency setting or reduce the current limit setting.			X		C	C

Table 56: Summary Table (continued)

Group Number (Hex)	Number (Decimal)	Display Name	Description	Type of Event				Inverter and Brake Chopper Action	
				I	W	F	PF	Inverter	Brake
0x2330	4352	Ground Fault 0	A high-impedance ground fault is detected on the output. Check the insulation of motor cable and motor.		X	X		C	
0x2330	4353	Ground Fault 1	A high-impedance ground fault is detected on the output. Check the insulation of motor cable and motor.		X	X		C	
0x2330	4354	Ground Fault 2	A low-impedance ground fault is detected on the output. Check the insulation of motor cable and motor.		X		X	C	
0x2330	4355	Ground Fault 21	A high or low-impedance ground fault is detected on the output. Check the insulation of motor cable and motor.		X		X	C	
0x2340	4356	Inverter Short Circuit	A short circuit at the inverter output is detected. Check the motor and motor cable.		X		X	C	
0x2340	4370	Output Current High 2	A critical output overcurrent is detected. Check for short circuits on the output.		X		X	C	
0x2340	4649	Desat Gate Driver	The gate driver has detected a desaturation condition.				X	C	C
0x23FE	4371	Current Imbalance	A current imbalance between paralleled power units is detected.		X				
0x23FF	4175	Motor Disconnected	The motor is disconnected.		X	X		C	
0x23FF	4176	Missing Motor Phase	A missing motor phase is detected. Check motor, motor cables, and connections.		X	X		C	
0x3110	4162	Grid Voltage Spikes	Excessive spikes on the grid voltage have been detected.		X	X		C	
0x3110	4164	Grid Voltage High	Grid voltage exceeded the instant high voltage limit. Check parameter Grid Overvoltage Instant Fault Limit (No. 2842).		X	X		C	C
0x3120	4165	Grid Voltage Low	Grid voltage dropped below the instant low voltage limit. Check parameter Grid Undervoltage Instant Fault Limit (No. 2843).		X	X		C	
0x3130	4160	Missing Grid Phase	A missing phase is detected on the grid side. Check the grid supply, cables, connections, and fuses.		X	X		C	
0x3130	4163	Grid Imbalance	A large imbalance of the grid voltages is detected. Check for uneven loads on the grid.		X	X		C	

Table 56: Summary Table (continued)

Group Number (Hex)	Number (Decimal)	Display Name	Description	Type of Event				Inverter and Brake Chopper Action	
				I	W	F	PF	Inverter	Brake
0x3140	4161	Grid Frequency Out of Range	Grid frequency is outside of operating range. Check parameter High Freq. Instant Fault Limit (No. 2840) for over frequency limit and parameter Low Freq. Instant Fault Limit (No. 2841) for under frequency limit.		X	X		C	
0x3140	4166	Grid Synchronization Error	The converter is unable to maintain the synchronization to the grid voltage. This error is only applicable if the converter is in one of the grid following modes.		X	X		C	
0x3211	4144	DC-link Voltage High 2	The voltage of the DC link is above the normal operating range and has reached a critical level. Can be caused by too fast motor braking or grid transients. Increase deceleration time, enable the overvoltage controller, use AC brake, or use a brake resistor while braking.		X	X		C	C
0x3212	4145	DC-link Voltage High 1	The voltage of the DC link is above the normal operating range. Can be caused by too fast motor braking or grid transients. Increase deceleration time, enable the overvoltage controller, use AC brake, or use a brake resistor while braking.		X	X		C	
0x3221	4146	DC-link Voltage Low	The DC-link voltage is below the normal operating range. Try to enable undervoltage protection to keep the drive running as long as possible.		X	X		C	C
0x32FF	4147	DC-link Voltage Ripple	Excessive voltage ripple is detected on the main DC-link capacitors. This can be caused by an imbalance of the grid. Reduce the output power.		X	X		C	
0x32FF	4148	DC-link Imbalance	An imbalance across the DC-link capacitors is detected. The imbalance can be caused by a component fault of the DC link. If the fault remains after resetting the drive, service is required.		X	X		C	
0x4110	4099	Ambient Temp. High	The ambient temperature is too high. Check the temperature and cooling conditions. Lower the temperature or improve the cooling conditions.		X				

Table 56: Summary Table (continued)

Group Number (Hex)	Number (Decimal)	Display Name	Description	Type of Event				Inverter and Brake Chopper Action	
				I	W	F	PF	Inverter	Brake
0x4210	4107	Brake Chopper Temp. Limit	The temperature of the brake chopper heat sink is at the upper limit of the normal temperature range. Check cooling and heat sink conditions. Reduce the generated regenerative power.		X				
0x4210	4108	Brake Chopper Temp. High 1	The temperature of the brake chopper heat sink has exceeded the normal temperature range. Check cooling and heat sink conditions. Reduce the generated regenerative power.		X	X		C	C
0x4210	4109	Brake Chopper Temp. High 2	The temperature of the brake chopper heat sink has reached a critical level. Check cooling and heat sink conditions. Reduce the generated regenerative power.		X	X		C	C
0x4220	4106	Brake Chopper Temp. Low	The temperature of the brake chopper heat sink is too low. Check the ambient temperature. Increase the ambient temperature or consider an external heater to increase the temperature around the drive.		X	X		C	C
0x4280	5132	Temp. Protection 1	Temperature protection 1 is triggered. The temperature has exceeded the configured value.		X	X		RC	
0x4280	5133	Temp. Protection 2	Temperature protection 2 is triggered. The temperature has exceeded the configured value.		X	X		RC	
0x4280	5134	Temp. Protection 3	Temperature protection 3 is triggered. The temperature has exceeded the configured value.		X	X		RC	
0x4280	5135	Temp. Protection 4	Temperature protection 4 is triggered. The temperature has exceeded the configured value.		X	X		RC	
0x4280	5136	Temp. Protection 5	Temperature protection 5 is triggered. The temperature has exceeded the configured value.		X	X		RC	
0x4280	5137	Temp. Protection 6	Temperature protection 6 is triggered. The temperature has exceeded the configured value.		X	X		RC	
0x4280	5158	Motor Temperature	The analog temperature sensor has exceeded the configured value.		X	X		RC	C
0x4281	5157	Motor Thermistor	The motor thermistor is too hot.			X		C	

Table 56: Summary Table (continued)

Group Number (Hex)	Number (Decimal)	Display Name	Description	Type of Event				Inverter and Brake Chopper Action	
				I	W	F	PF	Inverter	Brake
0x42FF	4200	Power Option Temp. High 1	The temperature of a power option has exceeded the normal temperature range. Check the cooling conditions. Reduce the load or the ambient temperature.		X	X		RC	C
0x42FF	4201	Power Option Temp. High 2	The temperature of a power option has reached a critical level. Check the cooling conditions. Reduce the load or the ambient temperature.		X	X		RC	C
0x42FF	4202	Power Option Temp. Low	The temperature of a power option component is too low. Check the ambient temperature. Increase the ambient temperature or consider an external heater to increase the temperature around the power option.		X	X		RC	C
0x42FF	4203	Power Option Temp. Limit	The temperature of a power option component is at the upper limit of the normal temperature. Check the cooling conditions. Reduce the load or the ambient temperature.		X				
0x42FF	4204	Power Option Temp. Imbal. 1	The thermal imbalance between the power option components exceeds the normal operating range.		X	X		RC	C
0x42FF	4205	Power Option Temp. Imbal. 2	An excessive thermal imbalance between power option components is detected.		X	X		RC	C
0x42FF	4206	Power Option Temp. Imbal. Limit	The thermal imbalance between the power option components is at the upper limit of the normal operating range.		X				
0x4310	4103	Inverter Temp. Limit	The temperature of the inverter heat sink is at the upper limit of the normal temperature range. Check cooling and heat sink conditions. Reduce the output current or ambient temperature. The drive may derate if the temperature is not lowered.		X				
0x4310	4104	Inverter Temp. High 1	The temperature of the inverter heat sink has exceeded the normal temperature level. Check cooling and heat sink conditions. Reduce the output current or ambient temperature.		X	X		C	C
0x4310	4105	Inverter Temp. High 2	The temperature of the inverter heat sink has reached a critical level. Check cooling and heat sink conditions. Reduce the output current to avoid a protected fault.		X	X		C	C

Table 56: Summary Table (continued)

Group Number (Hex)	Number (Decimal)	Display Name	Description	Type of Event				Inverter and Brake Chopper Action	
				I	W	F	PF	Inverter	Brake
0x4310	4110	IGBT Temp. High	An inverter IGBT overtemperature is detected. Reduce the ambient temperature, the output current and/or the switching frequency. Check the cooling and the condition of the heat sink.			X		C	C
0x4310	4113	Rectifier Temp. Limit	The temperature of the rectifier heat sink is at the upper limit of the normal temperature range. Check cooling and heat sink conditions. Reduce the output power (torque, speed) or the ambient temperature.		X				
0x4310	4114	Rectifier Temp. High 1	The temperature of the rectifier heat sink has exceeded the normal temperature range. Check cooling and heat sink conditions. Reduce the output power (torque, speed) or the ambient temperature.		X	X		C	C
0x4310	4115	Rectifier Temp. High 2	The temperature of the rectifier heat sink has reached a critical level. Check cooling and heat sink conditions. Reduce the output power (torque, speed) or the ambient temperature.		X	X		C	C
0x4310	4117	Power Unit Temp. Limit	The internal air temperature of the drive is at the upper limit of the normal temperature range. Check cooling and heat sink conditions. Reduce the output power (torque, speed) or the ambient temperature.		X				
0x4310	4118	Power Unit Temp. High 1	The internal air temperature of the drive has exceeded its normal temperature range. Check cooling and heat sink conditions. Reduce the output power (torque, speed) or the ambient temperature.		X	X		C	C
0x4310	4119	Power Unit Temp. High 2	The internal air temperature of the drive has reached a critical value. Check cooling and heat sink conditions. Reduce the output power (torque, speed) or the ambient temperature.		X	X		C	C
0x4310	4125	IGBT Temp. High	An inverter IGBT temperature has reached a critical value. Reduce the output current of the drive if possible to avoid a protected fault.			X		C	C

Table 56: Summary Table (continued)

Group Number (Hex)	Number (Decimal)	Display Name	Description	Type of Event				Inverter and Brake Chopper Action	
				I	W	F	PF	Inverter	Brake
0x4320	4102	Ambient Temp. Low	The drive is operated at a too low ambient temperature. Check the ambient temperature. Increase the ambient temperature or consider an external heater to increase the temperature around the drive.		X	X		C	C
0x4320	4112	Rectifier Temp. Low	The temperature of the rectifier heat sink is too low. Check the ambient temperature. Increase the ambient temperature or consider an external heater to increase the temperature around the drive.		X	X		C	C
0x4320	4116	Power Unit Temp. Low	The internal air temperature of the drive is below the normal operating range. The drive is operated at a too low ambient temperature. Consider an external heater to avoid this warning or fault.		X	X		C	C
0x4380	5240	Cooling Monitor	The cooling signal is missing.		X	X		C	C
0x43FE	4120	Control Board Temp. Low	The temperature of the control board is below the normal temperature range. The drive is operated at a too low ambient temperature. Check the ambient temperature. Increase the ambient temperature or consider an external heater to increase the temperature at the drive.		X	X		C	C
0x43FE	4121	Control Board Temp. Limit	The temperature of the control board is at the upper limit of the normal temperature range. Check cooling conditions and load of the control board. Reduce the load on the control board or the ambient temperature.		X				
0x43FE	4122	Control Board Temp. High 1	The temperature of the control board has exceeded its normal temperature range. Check cooling conditions and load of the control board. Reduce the load on the control board or the ambient temperature.		X	X		C	C
0x43FE	4123	Control Board Temp. High 2	The temperature of the control board has reached a critical level. Check cooling conditions and load of the control board. Reduce the load on the control board or the ambient temperature.		X	X		C	C
0x43FF	4124	Brake Chopper Temperature Imbalance	There is a temperature imbalance between 1 or more brake chopper IGBTs.		X				

Table 56: Summary Table (continued)

Group Number (Hex)	Number (Decimal)	Display Name	Description	Type of Event				Inverter and Brake Chopper Action	
				I	W	F	PF	Inverter	Brake
0x43FF	4126	IGBT Temperature Imbalance	There is a temperature imbalance between 1 or more IGBTs.		X				
0x43FF	4127	IGBT Temperature Imbalance	An excessive thermal imbalance between the IGBT modules is detected. Check the condition of IGBT modules their connections the cooling and the driver boards.		X				
0x43FF	4131	Temperature Imbalance Brake IGBT	There is a temperature imbalance between 1 or more brake chopper IGBTs.		X	X		C	C
0x43FF	4132	IGBT temperature delta	There is a temperature imbalance between 1 or more IGBTs.		X	X		C	C
0x43FF	4840	Tmax2MrectDelta	There is an imbalance between one or more of the rectifier power module temperatures.		X	X		C	C
0x43FF	4841	TlimitMrectDelta	There is an imbalance between one or more of the rectifier power module temperatures.		X				
0x4480	5400	AHF High Temp. Derate	A too high temperature is detected in the connected AHF (Advanced Harmonic Filter). Output is derated to 50%.			X			
0x4480	5401	AHF High Temp. Stop	A too high temperature is detected in the connected AHF (Advanced Harmonic Filter). Operation of the drive is stopped.			X		RC	
0x5100	4208	Service Mode Exit	The drive has left service mode. A power cycle is required to reset the drive.				X	C	C
0x5100	4641	24V Backup Mode	The drive is in 24V backup mode. The control section (including parameter configurations) and installed options are kept operational.	X					
0x5100	4803	Service Mode Active	Drive is in service mode.		X				
0x5112	4640	24V Supply Fault	The 24V supply is outside its normal operating range.				X	C	C
0x5114	4642	3.3V Supply Low	The voltage of the internal 3.3V supply is below its normal operating range.			X		C	C
0x5118	4643	28V Supply Low	The voltage of the internal 28V supply is below its normal operating range.			X		C	C
0x51FE	4644	Gate Driver Voltage Fault	The gate driver supply voltage is outside its normal operating range.				X	C	C
0x51FE	4653	Gate Driver Fault	A gate driver fault is detected or a link to the gate driver is broken.			X		C	C
0x51FF	4645	Power Board Supply Fault	A power supply fault on the power board is detected.				X	C	C

Table 56: Summary Table (continued)

Group Number (Hex)	Number (Decimal)	Display Name	Description	Type of Event				Inverter and Brake Chopper Action	
				I	W	F	PF	Inverter	Brake
0x51FF	4646	Power Supply Voltage	A power supply voltage is outside its normal operating range.				X	C	C
0x5210	4378	Current Sensor Fault	A defective current sensor or an error in the calibration of the current sensors is detected.			X		C	C
0x5400	5173	Power Limit Timeout Regenerative	The drive has exceeded the allowed time in power limit.			X		C	
0x5400	5174	Power Limit Timeout Motoring	The drive has exceeded the allowed time in power limit.			X		C	
0x5480	4152	Shoot Through Fault In Afe	Converter shoot through detected.			X		C	
0x54FD	4647	Function Disabled	The protection logic keeps the trip active until the configuration of the power unit protection levels is ready.			X		C	C
0x54FE	4628	STO Activated	The Safe Torque-Off (STO) is activated and an unintended restart is prevented until the STO-request is reset.		X			C	
0x54FE	4629	STO Fault Ch. A	The Safe Torque-Off (STO) is activated due to a discrepancy fault: Channel A is not activated, while channel B is activated.			X		C	C
0x54FE	4630	STO Fault Ch. B	The Safe Torque-Off (STO) is activated due to a discrepancy fault: Channel B is not activated, while channel A is activated.			X		C	C
0x54FF	4149	DC-link Short Circuit	An internal short circuit is detected in the DC link. Service is required.				X	C	C
0x54FF	4150	DC Capacitor Short Circuit	A short circuit in a DC-link capacitor is detected. Service is required.			X		C	C
0x54FF	4151	DC-link Short Circuit 2	A short circuit in the DC-link capacitor is detected. Service is required.	X			X	C	
0x5530	4790	Control Data Error	A data error is detected in the control data database EEPROM.	X					
0x5530	4791	Invalid PUD	A data error is detected in the power unit database EEPROM.			X		C	
0x6100	4134	System Time Adjust	System time is adjusted.	X					
0x6100	4135	Real Time Clock Hardware Error	A hardware error is detected in the real time clock.		X				
0x6100	4304	License Missing	A required license is missing.		X				
0x6100	4349	Authenticity Error	Files authenticity verification error occurred.			X		RC	C

Table 56: Summary Table (continued)

Group Number (Hex)	Number (Decimal)	Display Name	Description	Type of Event				Inverter and Brake Chopper Action	
				I	W	F	PF	Inverter	Brake
0x6100	4351	System Fault	A system fault is detected. See additional information for details.			X		C	C
0x6100	4357	Firmware Crash	A firmware crash occurred and detailed information is provided.			X		C	C
0x6100	4567	Restore Status	Provides information about the restore operation of a setting.	X					
0x6100	4568	Automatic Reset	All event conditions have cleared, and the triggered events are automatically reset.	X					
0x6100	4816	PLC Task Overrun	The high CPU load is inhibiting normal operation of the application (PLC task overrun).		X				
0x6100	4817	PLC Runtime Error	The PLC runtime has stopped responding. The application is halted.			X		C	C
0x6100	4832	Node Discovery	Node discovery and configuration are in progress. The modulation is inhibited.	X				RC	C
0x6100	4833	Node Commissioning	Nodes are being commissioned.		X			C	C
0x6100	4834	Node Missing	A previously commissioned node is no longer available. The drive is waiting for the node to be available. If the node has been removed, recommission the drive.	X					
0x6100	4851	Restart Required	A configuration change requires a soft-cycle or power-cycle to take effect. Modulation is inhibited.		X			C	C
0x6100	4853	StartupOccurrence	This occurrence masks over various occurrences that might be active during startup, that we dont want to show the end user	X					
0x6100	4854	ResetByDemand	Drive reset is requested by user, and will be performed shortly	X				C	
0x6100	4855	Internal Fault	An internal fault is detected. Cycle power, check the wiring if applicable, contact the service provider if the fault persists. Note the event number for further troubleshooting directions.			X		RC	C
0x6100	4856	Internal Fault	An internal fault is detected (connection from controller). Cycle power, check the internal wiring, contact the service provider if the fault persists. Note the event number for further troubleshooting directions.			X		C	C
0x6100	4857	Software Update	The drive is currently performing an update of the software.	X					

Table 56: Summary Table (continued)

Group Number (Hex)	Number (Decimal)	Display Name	Description	Type of Event				Inverter and Brake Chopper Action	
				I	W	F	PF	Inverter	Brake
0x6100	5100	Start Disabled in Reference Direction	Start is disabled because 'Enable Start Forward' or 'Enable Start Backward' is not active via input.		X				
0x6180	5260	Event Simulation	The event with the number 5260 is simulated.		X	X		C	C
0x6180	5264	Event Simulation SS2 Inst 1	Event simulation SS2 Instance 1.		X			C	C
0x6180	5265	Event Simulation SS2 Inst 2	Event simulation SS2 Instance 2.		X			C	C
0x6181	4980	A Digital Input terminal is unknown by system	A digital input terminal is selected that is unknown by the system. Maybe an option has been moved or removed.		X				
0x6181	4981	A Digital Output terminal is unknown by system	A digital output terminal is selected that is unknown by the system. Maybe an option has been moved or removed.		X				
0x6181	4982	An Analog Input terminal is unknown by system	An analog input terminal is selected that is unknown by the system. Maybe an option has been moved or removed.		X				
0x6181	4983	An Analog Output terminal is unknown by system	An analog output terminal is selected that is unknown by the system. Maybe an option has been moved or removed.		X				
0x6181	4984	A Digital Output occupied	A digital output is in use by an other function or fieldbus. If a fieldbus has taken control of a terminal, it has priority over parameter selection.		X				
0x6181	4985	An Analog Output occupied	An analog output is in use by another function or fieldbus. If a fieldbus has taken control of a terminal, it has priority over parameter selection.		X				
0x61F7	4800	Low Storage Space	The available storage space for the file system is low.	X					
0x61F7	4801	Data Logger Storage	Volume restriction limits are preventing additional data logger capture files from being stored.		X				
0x61F7	4802	Event Logger Storage	Volume restriction limits are preventing additional event log capture files from being stored.		X				

Table 56: Summary Table (continued)

Group Number (Hex)	Number (Decimal)	Display Name	Description	Type of Event				Inverter and Brake Chopper Action	
				I	W	F	PF	Inverter	Brake
0x61FB	4600	Option Communication Fault	A fault in the communication with an option is detected. Cycle power, check that the option is properly installed, contact the Danfoss supplier or the service department if the fault persists. Note the event number for further troubleshooting directions.			X		RC	C
0x61FB	4601	Internal Communication Fault	An internal communication fault is detected. Cycle power, check the wiring if applicable, contact the service provider if the fault persists. Note the event number for further troubleshooting directions.			X		RC	C
0x61FB	4602	Option Communication Fault	A fault in the communication with an option is detected. Cycle power, check that the option is properly installed, contact the Danfoss supplier or the service department if the fault persists. Note the event number for further troubleshooting directions.			X		C	C
0x61FB	4607	Internal Communication Fault	An internal communication fault is detected. Cycle power, check the wiring if applicable, contact the Danfoss supplier or the service department if the fault persists. Note the event number for further troubleshooting directions.			X		C	C
0x61FB	4631	Internal Communication Fault	An internal communication fault is detected. Cycle power, check the wiring if applicable, contact the Danfoss supplier or the service department if the fault persists. Note the event number for further troubleshooting directions.			X		RC	C
0x61FB	4632	Internal Communication Fault	An internal communication fault is detected. Cycle power, check the wiring if applicable, contact the service provider if the fault persists. Note the event number for further troubleshooting directions.		X				
0x61FB	4654	Control Node Disconnected	Internal communication route to one or more control nodes is disconnected.		X				
0x61FC	4605	Internal Communication Fault	An internal communication fault is detected. Cycle power, check the wiring if applicable, contact the service provider if the fault persists. Note the event number for further troubleshooting directions.			X		C	C

Table 56: Summary Table (continued)

Group Number (Hex)	Number (Decimal)	Display Name	Description	Type of Event				Inverter and Brake Chopper Action	
				I	W	F	PF	Inverter	Brake
0x61FC	4606	Internal Communication Fault	An internal communication fault is detected. Cycle power, check the wiring if applicable, contact the Danfoss supplier or the service department if the fault persists. Note the event number for further troubleshooting directions.			X		C	C
0x61FC	4639	High Speed Bus Sync Error	Internal error detected with high-speed bus connection to parallel control unit.			X		C	C
0x61FC	4648	High Speed Bus Error	Internal error detected with high-speed bus connection to parallel control unit.			X		C	C
0x61FC	4858	Internal Fault	An internal fault is detected. The power system has not received the required reference for modulation. Cycle power, check the wiring if applicable, contact the Danfoss supplier or the service department if the fault persists. Note the event number for further troubleshooting directions.		X	X		C	
0x61FC	4859	Internal Fault	An internal fault (connection from power system) is detected. Cycle power, check the internal wiring, contact the service provider if the fault persists. Note the event number for further troubleshooting directions.		X	X		C	
0x61FC	4860	Unexpected Time Adjust	An internal fault (unexpected time adjustment) is detected. Cycle power, check the internal wiring, contact the service provider if the fault persists. Note the event number for further troubleshooting directions.			X		C	C
0x61FC	4861	Synchronization Fault	An internal fault (time synchronization error between controller and power system) is detected. Cycle power, check the internal wiring, contact the service provider if the fault persists. Note the event number for further troubleshooting directions.			X		C	C
0x61FC	4862	PDS	An internal communication fault is detected. Cycle power, check the wiring if applicable, and contact the Danfoss supplier or the service department if the fault persists. Note the event number for further troubleshooting directions.			X		C	C

Table 56: Summary Table (continued)

Group Number (Hex)	Number (Decimal)	Display Name	Description	Type of Event				Inverter and Brake Chopper Action	
				I	W	F	PF	Inverter	Brake
0x61FC	4863	Internal Fault	An internal fault (connection with power system) is detected. Cycle power, check the internal wiring, contact the service provider if the fault persists. Note the event number for further troubleshooting directions.			X		C	C
0x6320	4350	Configuration Error	An invalid system configuration is detected.		X	X		C	C
0x6320	5301	Invalid Control Config.	An invalid control configuration is preventing operation.		X	X		C	
0x6320	5302	Start Blocked	Start of the motor is blocked. Check the Motor Ctrl. Ready Status Word for the cause.		X	X		C	
0x7012	5604	Motor Feedback Inversed	The feedback signal was running in the negative direction whereas the motor was running in the positive direction.			X		C	C
0x7012	5605	No Motor Feedback	Feedback signal is 0 or very low.			X		C	C
0x7080	5220	Brake Feedback Wrong State	Mechanical brake feedback is in a wrong state. Feedback state should reflect state of brake, except during opening or closing phases.		X				
0x7080	5221	Brake Priming Timeout	Brake priming has timed out. The drive could not produce the configured priming torque to open the brake safely.		X				
0x7080	5222	Brake Feedback Timeout	Brake feedback has timed out. The feedback signal is indicating that the mechanical brake has not opened or closed within the configured time.		X				
0x7080	5225	Brake Slip Error	A higher slip than the defined limit is detected in the mechanical brake. Check the condition of the mechanical brake.		X				
0x70FF	4128	Control Fan Failure	The control board cooling fan is not running at the commanded speed.		X				
0x70FF	4129	Main Fan Failure	The main cooling fan is not following its reference speed. Check the wiring of the fan and whether its blocked or polluted. Replace the fan if necessary.		X				
0x70FF	4130	Internal Fan Failure	The internal fan is running below its reference speed. Check the wiring of the fan and whether its blocked or polluted. Replace the fan if necessary.		X				

Table 56: Summary Table (continued)

Group Number (Hex)	Number (Decimal)	Display Name	Description	Type of Event				Inverter and Brake Chopper Action	
				I	W	F	PF	Inverter	Brake
0x70FF	4133	LCL Fan Speed Fault	LCL cooling fan not tracking commanded output.			X		C	C
0x7110	5204	Brake Resistor Test Active	The Brake Resistor Test is active. Normal run of the drive is not possible.		X				
0x7110	5205	Brake Resistor Test Failed	The Brake Resistor Test was unsuccessful. Check the brake resistor and its connections.			X		C	C
0x7110	5206	Brake Resistor Test Successful	The test of the brake resistor is performed successfully.	X					
0x7111	4403	Brake Ch. Switch Shorted	A short circuit of the brake chopper switch is detected, which can be dangerous. Disconnect power. Service is required.		X	X		C	
0x7113	4400	Brake Chopper Overload	A brake chopper overcurrent is detected. Reduce the brake voltage level and check the rating of the brake resistor.		X		X	C	C
0x7113	4401	Brake Resistor Temp. High	The brake resistor temperature is too high. Check the rating of the brake resistor and cooling conditions. Reduce the generated regenerative power.		X	X		C	C
0x7113	4402	Brake Resistor Missing	The brake resistor or its connection is missing.		X	X		C	
0x7113	4404	Brake Failure	A brake failure is detected, further testing will clarify the failure source. Coast first to run the test.		X			C	
0x7120	4177	Motor Thermal Overload	A thermal overload of the motor is detected. Check if the shaft torque is too high.		X	X		C	
0x7120	4178	Motor Speed High	The motor speed is above the normal operating range.		X	X		C	
0x7120	4179	AMA Current Low	The nominal current of the motor is too low for accurate results of automatic motor adaptation (AMA).		X				
0x7120	4180	Rotor Angle Detection Error	Rotor angle detection has failed. This might be as the motor is not suited to the drive or the motor is missing.		X	X		C	
0x7120	4181	Low Motor Saliency For High Frequency Injection Mode	Motor saliency is too low for HF injection mode.		X	X		C	
0x7120	4382	Blocked Rotor	The rotor is blocked.		X	X		C	
0x7120	5200	AMA Active	The AMA (Automatic Motor Adaptation) is active. Normal run of the motor is not possible. Apply a start signal to run the AMA.		X				

Table 56: Summary Table (continued)

Group Number (Hex)	Number (Decimal)	Display Name	Description	Type of Event				Inverter and Brake Chopper Action	
				I	W	F	PF	Inverter	Brake
0x7120	5201	AMA Motor Data	The motor data measurement of the AMA (Automatic Motor Adaptation) was unsuccessful.			X		C	C
0x7120	5202	AMA Motor Type	The motor type detection of the AMA (Automatic Motor Adaptation) was unsuccessful.			X		C	C
0x7120	5203	AMA Successful	The AMA (Automatic Motor Adaptation) was performed successfully.	X					
0x7120	5300	Invalid Motor Data	Invalid motor data is preventing operation. Check the motor data settings.		X	X		C	
0x7120	5600	Feedback Test Active	Normal running is suppressed for a motor feedback test run.		X				
0x7120	5601	Feedback Test Successful	The motor feedback test was able to verify the motor feedback signal.	X					
0x7120	5602	Feedback Resolution/Poles High	Feedback signal was slower than expected.			X		C	C
0x7120	5603	Feedback Resolution/Poles Low	Feedback signal was faster than expected.			X		C	C
0x7120	5606	Feedback Unstable	Feedback signal was inconsistent.			X		C	C
0x7122	4182	Motor Sync Loss	Select the drive response if the synchronization between motor and drive is lost. This is only relevant when using a permanent magnet or synchronous reluctance motor.		X	X		C	
0x72FF	4417	Feedback Option Fault	The Feedback Option is indicating a fault condition.			X		C	C
0x7300	4207	Sensor Configuration	A sensor configuration error is detected. A sensor is either missing, not expected, or incorrectly connected.			X		RC	
0x7310	4418	Bad Speed Feedback	Speed Feedback value is not reliable.			X		C	
0x7500	4638	Drive to Drive Connection Lost	Drive to drive connection is lost.		X	X		C	C
0x7580	5141	Control Panel Connection Lost	The connection to the control panel is lost. Control via control panel is released.						
0x7580	5142	PC Connection Lost	The connection to the PC tool is lost. PC control is released.						
0x8100	4256	Address Conflict	The fieldbus has identified an Address Conflict on the network which made the device back off.		X				

Table 56: Summary Table (continued)

Group Number (Hex)	Number (Decimal)	Display Name	Description	Type of Event				Inverter and Brake Chopper Action	
				I	W	F	PF	Inverter	Brake
0x8100	4257	Ethernet Cable Fault	When no link is present, a measurement is done to measure the distance to the far end of the cable. This warning occurs at measured distances > 4 m. This can occur when the device at the far end is turned off, disconnected, or the cable is broken. Check the cable at the distance provided in the detailed info.		X				
0x8100	4258	Invalid Fieldbus Configuration	An issue due to an invalid configuration of the fieldbus connection is detected. Features not supported by the device, mismatch between configured and actually available features or modules not available in the device. See additional detail info.	X	X				
0x8100	4260	Redundant Controller Missing	One or more of the expected fieldbus controllers are missing.		X				
0x8100	4261	Fieldbus Topology Mismatch	The current fieldbus topology does not match the topology provided at commissioning time.		X				
0x8100	4263	Ethernet Link Status Changed	A change of the Ethernet link status is detected. Additional info has details about which port and state.	X					
0x8100	4265	Ethernet Redundancy Error	Primary or backup physical path is missing.		X				
0x8100	4266	X1 Cable Redundancy	Indicates that physical path from X1 interface to the controller is missing or wrongly configured.		X				
0x8100	4267	X2 Cable Redundancy	Indicates that physical path from X2 interface to the controller is missing or wrongly configured.		X				
0x8100	4268	FieldbusStartUp	Internal occurrence to mask away TopologyMismatch occurrence during startup	X					
0x8100	4269	Network Time Protocol	Information of Network Time Protocol server. See detailed info.	X					
0x8100	4280	Controller Not in Run	Controller not in RUN state.		X				
0x8100	4281	Interface Configuration Change	Interface configuration for an ethernet port has changed. See detailed info.	X					
0x8100	5162	Alternative Control Place due to Fieldbus Timeout	Fieldbus process data timeout caused a change to the alternative control place.		X				

Table 56: Summary Table (continued)

Group Number (Hex)	Number (Decimal)	Display Name	Description	Type of Event				Inverter and Brake Chopper Action	
				I	W	F	PF	Inverter	Brake
0x81FD	4270	No Modbus TCP Connection	No Modbus TCP communication is currently established. This happens before the first connection is established, or if all connections have stopped (gracefully or disruptively).	X					
0x81FD	4271	No PROFINET Connection	No PROFINET I/O communication is currently established. This happens before the first connection is established, or if all connections have stopped (gracefully or disruptively).	X					
0x81FD	4272	No EtherNet/IP Connection	No EtherNet/IP communication is currently established. This happens before the first connection is established, or if all connections have stopped (gracefully or disruptively).	X					
0x81FD	4273	No EtherCAT Connection	No EtherCAT communication is currently established. This happens during start-up before the first connection is established, or if all connections has stopped (gracefully or disruptively).	X					
0x81FD	4282	No Modbus RTU Connection	No Modbus RTU communication is currently established. This event occurs during start-up until the first connection is established, or if all connections have stopped (gracefully or disruptively).	X					
0x81FE	4274	Loss of Modbus TCP I/O	One or more of the Fieldbus I/O connections has failed. This can happen when an established Fieldbus I/O Connection is disrupted by for example a cable break, or a power cut of the PLC or other infrastructure components.		X				
0x81FE	4275	Loss of PROFINET I/O	One or more of the Fieldbus I/O connections have failed. This can happen when an established Fieldbus I/O connection is disrupted by for example a cable break, or a power cut of the PLC or other infrastructure components.		X				
0x81FE	4276	Loss of EtherNet/IP I/O	One or more of the Fieldbus I/O connections have failed. This can happen when an established Fieldbus I/O Connection is disrupted by for example a cable break, or a power cut of the PLC or other infrastructure components.		X				

Table 56: Summary Table (continued)

Group Number (Hex)	Number (Decimal)	Display Name	Description	Type of Event				Inverter and Brake Chopper Action	
				I	W	F	PF	Inverter	Brake
0x81FE	4277	Loss of EtherCAT Connection	One or more of the fieldbus I/O connections has failed. This can happen when an established fieldbus I/O connection is disrupted by for example a cable break, or a power cut of the PLC or other infrastructure components.		X				
0x81FE	4283	Loss of Modbus RTU Connection	One or more of the fieldbus I/O connections has failed. This can happen when an established fieldbus I/O connection is disrupted by for example a cable break or a power cut of the PLC or other infrastructure components.		X				
0x81FF	4278	Primary Process Data Timeout	The fieldbus I/O data has not been updating any of the process data monitored by the primary process data monitor (Watchdog1). This can happen when the fieldbus has lost control or the current transferred I/O data is not valid.			X		C	C
0x81FF	4279	Secondary Process Data Timeout	The fieldbus I/O Data has not been updating any of the process data monitored by the secondary process data monitor (Watchdog2). This can happen when the fieldbus has lost control or the current transferred I/O data is not valid.			X		C	C
0x8331	5171	Torque Limit Timeout Motoring	The drive exceeded the allowed time in torque limit.			X		C	
0x8331	5172	Torque Limit Timeout Regenerative	The drive exceeded the allowed time in torque limit.			X		C	
0x8400	5210	Below Min. Speed	The Speed Monitor has detected that the speed is below the configured minimum speed.			X		C	C
0x8400	5211	Below Min. Speed	The Speed Monitor has detected that the speed is below the configured minimum speed.		X				
0x8400	5290	Speed Too High	The speed monitor has detected that the speed is above the configured maximum.			X		C	C
0x8400	5291	Speed Too High	The speed monitor has detected that the speed is above the configured maximum.		X				
0x8400	5292	Start Below Min. Speed	The start took too long. The speed has not reached the minimum speed within the time frame configured.			X		C	C

Table 56: Summary Table (continued)

Group Number (Hex)	Number (Decimal)	Display Name	Description	Type of Event				Inverter and Brake Chopper Action	
				I	W	F	PF	Inverter	Brake
0x8611	4192	Position Following Error	The actual position is outside the allowed range of the position error window around a position demand value for longer than the position error delay.		X				
0x8612	4193	Positive Position Limit	Motor position is outside the allowed positive range (PositionMax).	X	X			C	C
0x8612	4194	Position Command Rejected	Position command was rejected because of position software end limit.	X					
0x8612	4195	Positive Hardware End Limit	The positioning controller detected that the drive is exceeding the positive hardware end limits.	X	X			C	C
0x8612	4196	PositionLimitNeg	Motor position is outside the allowed negative range (PositionMin).	X	X			C	C
0x8612	4197	HwEndLimitNeg	Drive is exceeding the negative Hardware End Limits.	X	X			C	C
0x9080	5230	Lost Load Detected	Drive is not detecting any load on the motor shaft.						
0xF004	5270	Inertia Estimation Active	The drive is ready for performing the Inertia Estimation. A start command is required.	X					
0xF004	5271	Inertia Estimation Failed	The Inertia Estimation failed.			X		C	C
0xF004	5272	Inertia Estimation Successful	Inertia Estimation was performed successfully.	X					
0xFF01	5123	External Exception 1	External Exception 1.			X		C	
0xFF01	5124	External Exception 2	External Exception 2.			X		C	
0xFF02	5701	Preventive Maintenance 1	Preventive Maintenance Service Request 1.		X				
0xFF02	5702	Preventive Maintenance 2	Preventive Maintenance Service Request 2.		X				
0xFF02	5703	Preventive Maintenance 3	Preventive Maintenance Service Request 3.		X				
0xFF02	5704	Preventive Maintenance 4	Preventive Maintenance Service Request 4.		X				
0xFF02	5705	Preventive Maintenance 5	Preventive Maintenance Service Request 5.		X				
0xFF02	5706	Preventive Maintenance 6	Preventive Maintenance Service Request 6.		X				
0xFF02	5707	Preventive Maintenance 7	Preventive Maintenance Service Request 7.		X				
0xFF02	5708	Preventive Maintenance 8	Preventive Maintenance Service Request 8.		X				
0xFF02	5709	Preventive Maintenance 9	Preventive Maintenance Service Request 9.		X				
0xFF02	5710	Preventive Maintenance 10	Preventive Maintenance Service Request 10.		X				
0xFF06	5901	Logic Input Error	Configured input function reports an error.		X				

Table 56: Summary Table (continued)

Group Number (Hex)	Number (Decimal)	Display Name	Description	Type of Event				Inverter and Brake Chopper Action	
				I	W	F	PF	Inverter	Brake
0xFF06	5902	Logic Output Error	Configured output function reports an error.		X				
0xFF06	5903	Logic Block Configuration Error	Logic block configuration is incorrect.		X				
0xFF06	5904	Logic State Error	Logic state handling reports an error.		X				

* indicates that the event's response can be configured using a parameter.

Any information, including, but not limited to information on selection of product, its application or use, product design, weight, dimensions, capacity or any other technical data in product manuals, catalog descriptions, advertisements, etc. and whether made available in writing, orally, electronically, online or via download, shall be considered informative, and is only binding if and to the extent, explicit reference is made in a quotation or order confirmation. Danfoss cannot accept any responsibility for possible errors in catalogs, brochures, videos and other material. Danfoss reserves the right to alter its products without notice. This also applies to products ordered but not delivered provided that such alterations can be made without changes to form, fit or function of the product. All trademarks in this material are property of Danfoss A/S or Danfoss group companies. Danfoss and the Danfoss logo are trademarks of Danfoss A/S. All rights reserved.

M00104

