

SIEMENS

SITRANS P

Pressure transmitter SITRANS P210

Compact Operating Instructions

<u>Introduction</u>	1
<u>Safety instructions</u>	2
<u>Description</u>	3
<u>Installing/mounting</u>	4
<u>Connecting</u>	5
<u>Commissioning</u>	6
<u>Service and maintenance</u>	7
<u>Technical specifications</u>	8
<u>Dimension drawings</u>	9
<u>Product documentation and support</u>	A

7MF1566

Legal information

Warning notice system

This manual contains notices you have to observe in order to ensure your personal safety, as well as to prevent damage to property. The notices referring to your personal safety are highlighted in the manual by a safety alert symbol, notices referring only to property damage have no safety alert symbol. These notices shown below are graded according to the degree of danger.

 DANGER
indicates that death or severe personal injury will result if proper precautions are not taken.

 WARNING
indicates that death or severe personal injury may result if proper precautions are not taken.

 CAUTION
indicates that minor personal injury can result if proper precautions are not taken.

NOTICE
indicates that property damage can result if proper precautions are not taken.

If more than one degree of danger is present, the warning notice representing the highest degree of danger will be used. A notice warning of injury to persons with a safety alert symbol may also include a warning relating to property damage.

Qualified Personnel

The product/system described in this documentation may be operated only by **personnel qualified** for the specific task in accordance with the relevant documentation, in particular its warning notices and safety instructions. Qualified personnel are those who, based on their training and experience, are capable of identifying risks and avoiding potential hazards when working with these products/systems.

Proper use of Siemens products

Note the following:

 WARNING
Siemens products may only be used for the applications described in the catalog and in the relevant technical documentation. If products and components from other manufacturers are used, these must be recommended or approved by Siemens. Proper transport, storage, installation, assembly, commissioning, operation and maintenance are required to ensure that the products operate safely and without any problems. The permissible ambient conditions must be complied with. The information in the relevant documentation must be observed.

Trademarks

All names identified by ® are registered trademarks of Siemens AG. The remaining trademarks in this publication may be trademarks whose use by third parties for their own purposes could violate the rights of the owner.

Disclaimer of Liability

We have reviewed the contents of this publication to ensure consistency with the hardware and software described. Since variance cannot be precluded entirely, we cannot guarantee full consistency. However, the information in this publication is reviewed regularly and any necessary corrections are included in subsequent editions.

Table of contents

1	Introduction	5
1.1	Purpose of this documentation	5
1.2	Checking the consignment.....	5
1.3	Transportation and storage	5
1.4	Notes on warranty	6
2	Safety instructions	7
2.1	Prerequisites for safe use.....	7
2.1.1	Laws and directives	7
2.1.2	Conformity with European directives	7
2.1.3	Conformity with UK directives	8
2.2	Improper device modifications.....	8
2.3	Requirements for special applications	8
2.4	Use in hazardous areas.....	9
3	Description	11
3.1	Application	11
3.2	Hardware configuration	11
3.3	Layout of the nameplate	12
4	Installing/mounting	15
4.1	Basic safety instructions	15
4.2	Additional notes on installation of explosion protection devices	16
4.3	Installation	16
5	Connecting	17
5.1	Basic safety instructions	17
5.1.1	Grounding for Ex (explosion protection) devices	17
5.2	Electrical connections	19
6	Commissioning	21
6.1	Correction of zero point and span.....	21
7	Service and maintenance	23
7.1	Basic safety instructions	23
7.2	Maintenance.....	23
7.3	Return procedure	23
7.4	Disposal.....	24

8	Technical specifications	25
8.1	General technical specifications.....	25
8.2	Certificates and approvals.....	27
9	Dimension drawings	29
9.1	Dimensional drawings electrical connections.....	29
9.2	Dimensional drawings process connections	29
A	Product documentation and support	31
A.1	Product documentation	31
A.2	Technical support.....	32
	Index	33

Introduction

1.1 Purpose of this documentation

These instructions contain all information required to commission and use the device. Read the instructions carefully prior to installation and commissioning. In order to use the device correctly, first review its principle of operation.

The instructions are aimed at persons mechanically installing the device, connecting it electronically, configuring the parameters and commissioning it, as well as service and maintenance engineers.

1.2 Checking the consignment

1. Check the packaging and the delivered items for visible damages.
2. Report any claims for damages immediately to the shipping company.
3. Retain damaged parts for clarification.
4. Check the scope of delivery by comparing your order to the shipping documents for correctness and completeness.



WARNING

Using a damaged or incomplete device

Risk of explosion in hazardous areas.

- Do not use damaged or incomplete devices.

1.3 Transportation and storage

To guarantee sufficient protection during transport and storage, observe the following:

- Keep the original packaging for subsequent transportation.
- Devices/replacement parts should be returned in their original packaging.
- If the original packaging is no longer available, ensure that all shipments are properly packaged to provide sufficient protection during transport. Siemens cannot assume liability for any costs associated with transportation damages.

NOTICE

Insufficient protection during storage

The packaging only provides limited protection against moisture and infiltration.

- Provide additional packaging as necessary.

1.4 Notes on warranty

Special conditions for storage and transportation of the device are listed in Technical specifications (Page 25).

1.4 Notes on warranty

The contents of this manual shall not become part of or modify any prior or existing agreement, commitment or legal relationship. The sales contract contains all obligations on the part of Siemens as well as the complete and solely applicable warranty conditions. Any statements regarding device versions described in the manual do not create new warranties or modify the existing warranty.

The content reflects the technical status at the time of publishing. Siemens reserves the right to make technical changes in the course of further development.

Safety instructions

2.1 Prerequisites for safe use

This device left the factory in good working condition. In order to maintain this status and to ensure safe operation of the device, observe these instructions and all the specifications relevant to safety.

Observe the information and symbols on the device. Do not remove any information or symbols from the device. Always keep the information and symbols in a completely legible state.

Symbol	Explanation
	Consult operating instructions

2.1.1 Laws and directives

Observe the safety rules, provisions and laws applicable in your country during connection, assembly and operation. These include, for example:

- National Electrical Code (NEC - NFPA 70) (USA)
- Canadian Electrical Code (CEC) (Canada)

Further provisions for hazardous area applications are for example:

- IEC 60079-14 (international)
- EN 60079-14 (EU)

2.1.2 Conformity with European directives

The CE mark on the device is a sign of conformity with the following European directives:

Electromagnetic compatibility EMC 2014/30/EU	Directive of the European Parliament and of the Council on the harmonisation of the laws of the Member States relating to electromagnetic compatibility.
Atmosphère explosible ATEX 2014/34/EU	Directive of the European Parliament and of the Council on the harmonisation of the laws of the Member States relating to equipment and protective systems intended for use in potentially explosive atmospheres.
2011/65/EU RoHS	Directive of the European Parliament and of the Council on the restriction of the use of certain hazardous substances in electrical and electronic equipment

2.3 Requirements for special applications

The standards applied can be found in the EC declaration of conformity for the device.

2.1.3 Conformity with UK directives

The UKCA marking on the device shows conformity with the following UK regulations:

Electromagnetic Compatibility SI 2016/1091	Electromagnetic Compatibility Directive 2016
Explosive Atmospheres SI 2016/1107	Directive for Equipment and Protective Systems Intended for use in Potentially Explosive Atmospheres 2016
Directive on the Restriction of the Use of Certain Hazardous Substances SI 2012/3032	Directive on the Restriction of the Use of Certain Hazardous Substances in Electrical and Electronic Equipment 2012

The applicable regulations can be found in the UKCA declaration of conformity of the specific device.

2.2 Improper device modifications

 WARNING
Improper device modifications Risk to personnel, system and environment can result from modifications to the device, particularly in hazardous areas. <ul style="list-style-type: none">• Only carry out modifications that are described in the instructions for the device. Failure to observe this requirement cancels the manufacturer's warranty and the product approvals.

2.3 Requirements for special applications

Due to the large number of possible applications, each detail of the described device versions for each possible scenario during commissioning, operation, maintenance or operation in systems cannot be considered in the instructions. If you need additional information not covered by these instructions, contact your local Siemens office or company representative.

Note

Operation under special ambient conditions

We highly recommend that you contact your Siemens representative or our application department before you operate the device under special ambient conditions as can be encountered in nuclear power plants or when the device is used for research and development purposes.

2.4 Use in hazardous areas

Qualified personnel for hazardous area applications

Persons who install, connect, commission, operate, and service the device in a hazardous area must have the following specific qualifications:

- They are authorized, trained or instructed in operating and maintaining devices and systems according to the safety regulations for electrical circuits, high pressures, aggressive, and hazardous media.
- They are authorized, trained, or instructed in carrying out work on electrical circuits for hazardous systems.
- They are trained or instructed in maintenance and use of appropriate safety equipment according to the pertinent safety regulations.

 WARNING
Use in hazardous area Risk of explosion. <ul style="list-style-type: none">• Only use equipment that is approved for use in the intended hazardous area and labeled accordingly.• Do not use devices that have been operated outside the conditions specified for hazardous areas. If you have used the device outside the conditions for hazardous areas, make all Ex markings unrecognizable on the nameplate.

 WARNING
Loss of safety of device with type of protection "Intrinsic safety Ex i" If the device has already been operated in non-intrinsically safe circuits or the electrical specifications have not been observed, the safety of the device is no longer ensured for use in hazardous areas. There is a risk of explosion. <ul style="list-style-type: none">• Connect the device with type of protection "Intrinsic safety" solely to an intrinsically safe circuit.• Observe the specifications for the electrical data on the certificate and/or in Technical specifications (Page 25).

2.4 Use in hazardous areas

Description

3.1 Application

The pressure transmitter is used for measuring the gauge pressure of gases and liquids in the following industrial areas:

- Mechanical engineering
- Power engineering
- Water supply
- Shipbuilding
- Chemical industry
- Pharmaceuticals

3.2 Hardware configuration

Device structure without explosion protection





The pressure transmitter consists of a piezo-resistive measuring cell with a diaphragm installed in a stainless steel enclosure. It can be electrically connected using a plug complying with EN 175301-803-A (IP65), a round plug M12 (IP67), a cable (IP67) or a fast-fit cable gland (IP67). The output signal is between 4 and 20 mA or 0 and 10 V.

Device structure with explosion protection

The pressure transmitter consists of a piezo-resistive measuring cell with a diaphragm installed in a stainless steel enclosure. It can be connected electrically with a connector fulfilling EN 175301-803-A (IP65) or a round plug M12 (IP67). The output signal amounts to between 4 and 20 mA.

3.3 Layout of the nameplate

Table 3-1 Overview of the different variants

			
7MF1566 with plug in accordance with EN 175301-803-A <ul style="list-style-type: none"> Type 7MF1566-.....-1..1 Type 7MF1566-.....-5..1 	7MF1566 with plug M12x1 <ul style="list-style-type: none"> Type 7MF1566-.....-2..1 	7MF1566 with cable (2 m) <ul style="list-style-type: none"> Type 7MF1566-.....-3..1 	7MF1566 with fast-fit cable gland <ul style="list-style-type: none"> Type 7MF1566-.....-4..1

3.3 Layout of the nameplate

Manufacturing date is visible on the label of the pressure transmitter, e.g.: LKK-YMDD-XXX-XX-XXX

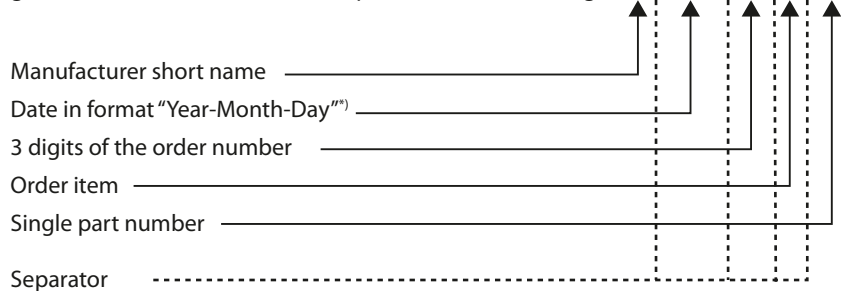

*) Decoding for year, month and day information

Code	Year
A	2010
B	2011
C	2012
D	2013
E	2014
F	2015
H (G) ¹⁾	2016
J	2017
K	2018
L	2019
M	2020

Code	Year
N	2021
P	2022
R	2023
S	2024
T	2025
U	2026
V	2027
W	2028
X	2029

Code	Month
1	January
2	February
3	March
4	April
5	May
6	June
7	July
8	August
9	September
O	October
N	November
D	December

Code	01-31
Day of month	1st to 31st day

¹⁾ Conforming to DIN EN 60062

²⁾ The letter G is not permitted for new applications since it deviates from DIN EN 60062. It serves only for coding back.

Description

3.3 Layout of the nameplate

Installing/mounting

4.1 Basic safety instructions

 DANGER
Pressure applications Danger to personnel, system and environment will result from improper disassembly. <ul style="list-style-type: none">• Never attempt to loosen, remove, or disassemble process connection while vessel contents are under pressure.

 CAUTION
Direct sunlight Device damage. The device can overheat or materials become brittle due to UV exposure. <ul style="list-style-type: none">• Protect the device from direct sunlight.• Make sure that the maximum permissible ambient temperature is not exceeded. Refer to the information in Technical specifications (Page 25).

 WARNING
Wetted parts unsuitable for the process media Risk of injury or damage to device. Hot, toxic and corrosive media could be released if the process medium is unsuitable for the wetted parts. <ul style="list-style-type: none">• Ensure that the material of the device parts wetted by the process medium is suitable for the medium. Refer to the information in Technical specifications (Page 25).

Note

Material compatibility

Siemens can provide you with support concerning selection of sensor components wetted by process media. However, you are responsible for the selection of components. Siemens accepts no liability for faults or failures resulting from incompatible materials.

4.2 Additional notes on installation of explosion protection devices

Operation is permitted only when connected to certified intrinsically-safe resistive circuits with the following maximum values:

U_i	$\leq 30 \text{ V}$
I_i	$\leq 100 \text{ mA}$
P_i	$\leq 750 \text{ mW}$ Internal inductance $L_i = 0 \text{ nH}$ Internal capacitance $C_i = 0 \text{ nF}$

A maximum ambient air temperature T_a of -25 °C to $+85 \text{ °C}$ is permitted for the pressure transmitter.

Use as a resource belonging to Category 1/2:

The pressure transmitters can be mounted in the wall separating the area with Category 1 requirements (Zone 0) and the area with Category 2 requirements (Zone 1). In this case, the process connection must be adequately sealed in compliance with IEC/EN 60079-26, Clause 4.3, for example by providing degree of protection IP67 in compliance with EN60529. The supply must be effected via intrinsically safe circuits with type of protection ia. The measuring cell may only be used for flammable materials to which the diaphragms of the measuring cells are adequately resistant both chemically and in terms of corrosion.

4.3 Installation

- The location of the device has no influence on the measurement accuracy.
- Before installation, compare the process data with the data of the rating plate.
- The medium being measured must be suitable for the parts of the pressure transmitter in contact with the medium.
- The overload limit must not be exceeded.
- Connect the devices with fixed cable installation.

Connecting

5.1 Basic safety instructions

 WARNING
<p>Unsuitable cables, cable glands and / plug-in connectors</p> <p>Danger of explosion in hazardous areas.</p> <ul style="list-style-type: none"> • Only use cable glands/plug-in connectors that fulfill the requirements of the relevant type of protection. • Only use cables that have been designed for an ambient temperature of at least 20 K higher. • Close cable openings for electrical connections that are unused. • When replacing cable glands, only use ones of the same type. • After installation check that the cables are seated firmly.

 WARNING
<p>Improper power supply</p> <p>Risk of explosion in hazardous areas as result of incorrect power supply, e.g. using direct current instead of alternating current.</p> <ul style="list-style-type: none"> • Connect the device in accordance with the specified power supply and signal circuits. The relevant specifications can be found in the certificates, in Technical specifications (Page 25) or on the nameplate.

5.1.1 Grounding for Ex (explosion protection) devices

 WARNING
<p>Lack of equipotential bonding</p> <p>Danger of explosion through compensating currents or ignition currents through lack of equipotential bonding.</p> <ul style="list-style-type: none"> • Make sure that equipotential bonding exists for the device. • The pressure transmitter must be connected to the equipotential bonding system of the plant via the metal housing (process connection) or the ground conductor of the plug. <p>Exception: It may be permissible to omit connection of the equipotential bonding for devices with type of protection "Intrinsic safety Ex i".</p>

 **WARNING**

Unprotected cable ends

Risk of explosion through unprotected cable ends in hazardous areas.

- Protect unused cable ends in accordance with IEC/EN 60079-14.

 **WARNING**

Connecting device in an energized state / Disconnecting device from power supply in an energized state

Risk of explosion in hazardous areas.

- In hazardous areas, only connect the device in a de-energized state and only disconnect the device from the power supply in a de-energized state.

Exceptions:

- Devices with the "Intrinsic safety Ex i" type of protection may also be connected or disconnected in an energized state in hazardous areas.
- Exceptions for "Non-sparking nA" type of protection (Zone 2) are regulated in the relevant certificate.

Note

Electromagnetic compatibility (EMC)

You can use this device in industrial environments, households and small businesses.

For metal enclosures there is an increased electromagnetic compatibility compared to high-frequency radiation. This protection can be increased by grounding the enclosure.

Note

Improvement of interference immunity

- Lay signal cables separately to cables with voltages > 60 V.
 - Use cable with twisted wires.
 - Keep the device and the cables at a distance from strong electromagnetic fields.
-

Note

Power supply

The device should only be supplied with limited energy according to UL61010-1 Second Edition, Section 9.3 or LPS (Low Power Supply) in accordance with UL60950-1 or Class 2 in accordance with UL1310 or UL1585.

5.2 Electrical connections

Legend			
I_o	Output current	U_B	Auxiliary power
U_o	Output voltage	\perp	Grounding
		R_L	Load

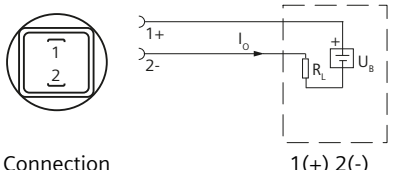
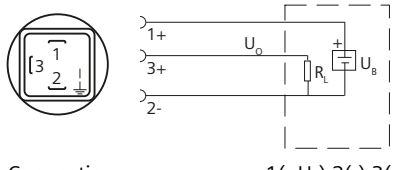
Connecting with current output and connector in accordance with EN 175301	Connecting with voltage output and connector in accordance with EN 175301
 <p>Connection 1(+) 2(-)</p>	 <p>Connection 1(+U_B) 2(-) 3(+U_o)</p>

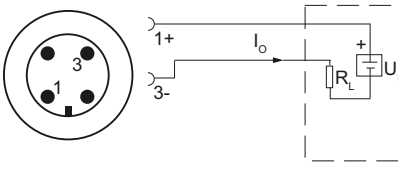
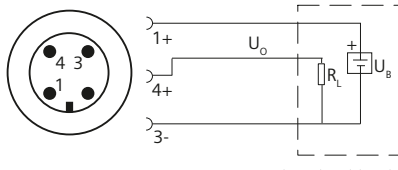
Connecting with current output and connector M12x1	Connecting with voltage output and connector M12x1
 <p>Connection 1(+) 3(-)</p>	 <p>Connection 1(+U_B) 3(-) 4(+U_o)</p>

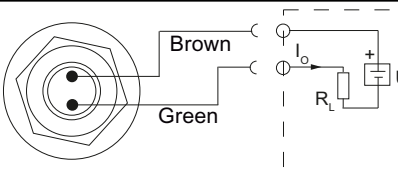
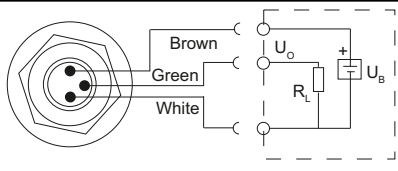
Connecting with current output and cable	Connecting with voltage output and cable
 <p>Connection Brown (+) Green (-)</p>	 <p>Connection Brown (+U_B) White (-) Green (+U_o)</p>

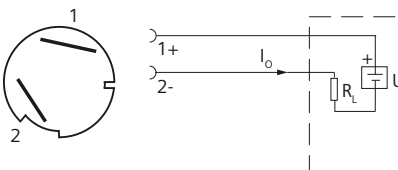
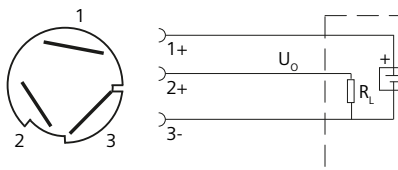
Connecting with current output and fast-fit cable gland	Connecting with voltage output and fast-fit cable gland
 <p>Connection 1(+) 2(-)</p>	 <p>Connection 1(+U_B) 2(+U_o) 3(-)</p>

Version with explosion protection: 4 to 20 mA

The grounding connection is conductively bonded to the transmitter enclosure.

Connecting with current output and connector in accordance with EN 175301 (Ex)

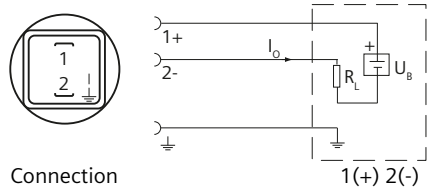

Connecting with current output and connector M12x1 (Ex)

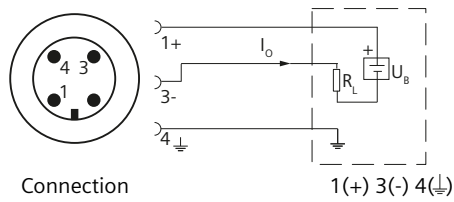

Commissioning

**WARNING****Improper commissioning in hazardous areas**

Device failure or risk of explosion in hazardous areas.

- Do not commission the device until it has been mounted completely and connected in accordance with the information in Technical specifications (Page 25).
- Before commissioning take the effect on other devices in the system into account.

6.1 Correction of zero point and span

The transmitter is preset to the specific measuring range by the manufacturer. An additional setting is not possible.

Service and maintenance

7.1 Basic safety instructions

 WARNING
Impermissible repair of explosion protected devices Risk of explosion in hazardous areas <ul style="list-style-type: none">• Repair must be carried out by Siemens authorized personnel only.

 WARNING
Use of a computer in a hazardous area If the interface to the computer is used in the hazardous area, there is a risk of explosion. <ul style="list-style-type: none">• Ensure that the atmosphere is explosion-free (hot work permit).

7.2 Maintenance

The transmitter is maintenance-free.

Check the start of scale value of the device from time to time.

 WARNING
Impermissible accessories and spare parts Risk of explosion in areas subject to explosion hazard. <ul style="list-style-type: none">• Only use original accessories or original spare parts.• Observe all relevant installation and safety instructions described in the instructions for the device or enclosed with the accessory or spare part.

7.3 Return procedure

To return a product to Siemens, see Return to Siemens (<https://support.industry.siemens.com/cs/ww/en/sc/3098>).

Contact your Siemens representative to clarify if a product is repairable, and how to return it. They can also help with quick repair processing, a repair cost estimate, or a repair report/ cause of failure report.

NOTICE

Decontamination

The product may have to be decontaminated before it is returned. Your Siemens contact person will let you know for which products this is required.

7.4 Disposal



Devices described in this manual should be recycled. They may not be disposed of in the municipal waste disposal services according to the Directive 2012/19/EC on waste electronic and electrical equipment (WEEE).

Devices can be returned to the supplier within the EC and UK, or to a locally approved disposal service for eco-friendly recycling. Observe the specific regulations valid in your country.

Further information about devices containing batteries can be found at: Information on battery/product return (WEEE) (<https://support.industry.siemens.com/cs/document/109479891/>)

Note

Special disposal required

The device includes components that require special disposal.

- Dispose of the device properly and environmentally through a local waste disposal contractor.
-

Technical specifications

8.1 General technical specifications





Mode of operation		
Measuring range $\geq 100 \dots \leq 600$ bar	Piezo-resistive with stainless steel diaphragm	
Input		
Measured variable input		
Measuring range for gauge pressure	Overload limit	Burst pressure
0 ... 100 mbar g	$\geq -400 / \leq 400$ mbar g	1 bar g
0 ... 160 mbar g	$\geq -400 / \leq 400$ mbar g	1 bar g
0 ... 250 mbar g	$\geq -800 / \leq 1000$ mbar g	2 bar g
0 ... 400 mbar g	$\geq -800 / \leq 1000$ mbar g	2 bar g
0 ... 600 mbar g	$\geq -1000 / \leq 2000$ mbar g	3 bar g
Output		
Current signal	4 ... 20 mA	
• Load	$(U_B - 10 \text{ V}) / 0.02 \text{ A}$	
• Auxiliary power U_B	7 ... 33 V DC <u> </u> (10 ... 30 V for Ex)	
• Current consumption I_B	≤ 20 mA	
Voltage signal	0 ... 10 V DC <u> </u>	
• Load	≥ 10 k Ω	
• Auxiliary power U_B	12 ... 33 V DC <u> </u>	
• Current consumption	< 7 mA at 10 k Ω	
Characteristic curve	Linear rising	
Measuring accuracy		
Measurement deviation at 25 °C (77 °F), including characteristic curve deviation, hysteresis and repeatability	<ul style="list-style-type: none"> • Typical: 0.25% of full-scale value • Maximum: 0.5% of full-scale value • With EMC radiation, the deviation in the measurement accuracy is up to 1%. 	
Set-up time T99	< 0.1 s	
Long-term drift		
• Start of scale value and measuring span	0.25% of full-scale value/year	
Effect of ambient temperature		
• Start of scale value and measuring span	<ul style="list-style-type: none"> • 0.25%/10 K of full-scale value • 0.5%/10 K of full-scale value for a measuring range of 100 ... 400 mbar 	

8.1 General technical specifications

Measuring accuracy			
• Influence of vibration (per IEC 60068-2-6)	0.005%/g to 500 Hz in all directions		
• Effect of auxiliary power supply	0.005%/V		
Rated conditions			
Ambient temperature	-25 ... +85 °C (-13 ... +185 °F)		
• Height	Max. 2 000 m above mean sea level Use a suitable power supply at an altitude of more than 2 000 m above mean sea level.		
• Relative humidity	0 ... 100%		
Storage temperature	-50 ... +100 °C (-58 ... +212 °F)		
Degree of protection (according to EN 60529)	<ul style="list-style-type: none"> • IP65 with plug according to EN 175301-803-A • IP67 with M12 plug • IP67 with cable • IP67 with fast-fit cable gland 		
Electromagnetic compatibility	<ul style="list-style-type: none"> • In accordance with EN 61326-1 • In accordance with EN 61326-2-3 • In accordance with NAMUR NE21, only for ATEX devices and with a maximum measurement deviation of $\leq 1\%$ 		
Mechanical construction			
Weight	Approx. 0.090 kg (0.198 lb)		
Process connections	Dimension drawings (Page 29)		
Electrical connections	<ul style="list-style-type: none"> • Plug in accordance with EN 175301-803-A shape A with cable entry M16x1.5 or 1/2-14NPT or Pg 11 • M12 plug • 2- or 3-wire (0.5 mm²) cable (Ø 5.4 mm) • Fast-fit cable gland 		
Material of the wetted parts			
• Measuring cell	Stainless steel, mat. no. 1.4435		
• Process connection	Stainless steel, Mat. No. 1.4404 (SST 316 L)		
• Sealing material	15th digit in the order number	Medium temperature	
	Viton (FPM)	A	-15 ... +125 °C (+5 ... +257 °F)
	Neoprene (CR)	B	-35 ... +100 °C < 100 bar (-31 ... +212 °F; < 1 450 psi)
	Perbunan (NBR)	C	-20 ... +100 °C (-4 ... +212 F)
	EPDM	D	-40 ... +125 °C < 100 bar (-40 ... +257 °F; < 1 450 psi), can be used for drinking water
Non-wetted parts material			
• Enclosure	Stainless steel, Mat. No. 1.4404 (SST 316 L)		

Mechanical construction	
• Connector enclosure	• Plastic • CuZn, nickel-plated (M12 plug)
• Cable	PVC spec.

8.2 Certificates and approvals

Certificates and approvals	
Classification according to pressure equipment directive (PED 2014/68/EU)	For gases of Fluid Group 1 and liquids of Fluid Group 1; meets the requirements of Article 4 Para. 3 (good engineering practice)
Explosion protection in accordance with ATEX	
Intrinsic safety "i" (only with current output)	<ul style="list-style-type: none"> •  II 1/2 G Ex ia IIC T4 Ga/Gb •  II 1/2 D Ex ia IIIC T125 °C Da/Db
EC type-examination certificate	SEV 10 ATEX 0146
Connection to certified intrinsically-safe resistive circuits with maximum values	$U_i \leq 30 \text{ VDC}$; $I_i \leq 100 \text{ mA}$; $P_i \leq 0.75 \text{ W}$
Effective internal inductance and capacitance for versions with plugs according to EN 175301-803-A and M12 plugs	$L_i = 0 \text{ nH}$; $C_i = 0 \text{ nF}$
Explosion protection in accordance with UKEX CML 22 UKEX 2174	
Intrinsic safety "i" (only with current output)	<ul style="list-style-type: none"> •  II 1/2 G Ex ia IIC T4 Ga/Gb •  II 1/2 D Ex ia IIIC T125 °C Da/Db

Dimension drawings

9.1 Dimensional drawings electrical connections

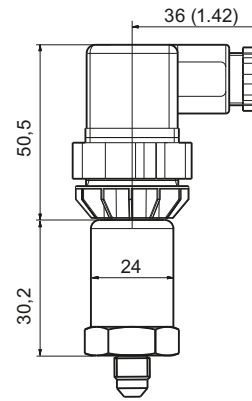
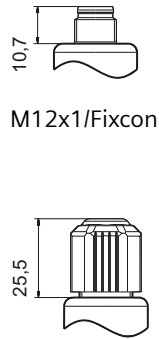

M16x1.5 or 0.5-14 NPT

9.2 Dimensional drawings process connections

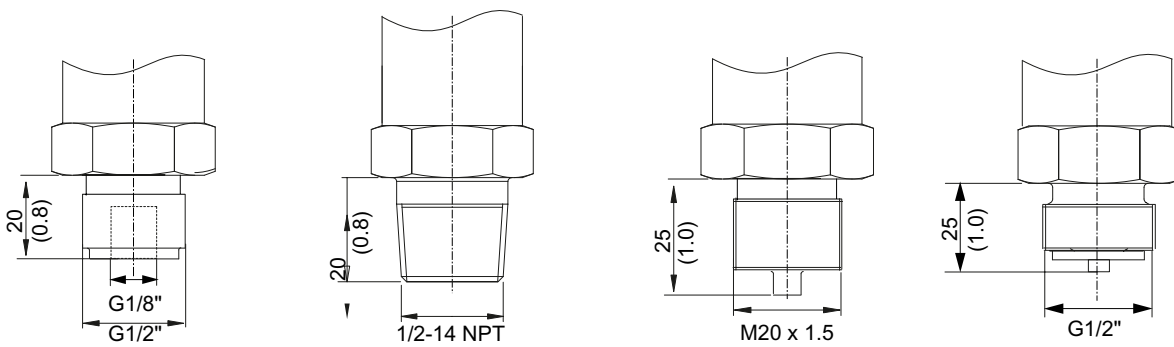

Figure 9-1 Max. 30 Nm

9.2 Dimensional drawings process connections

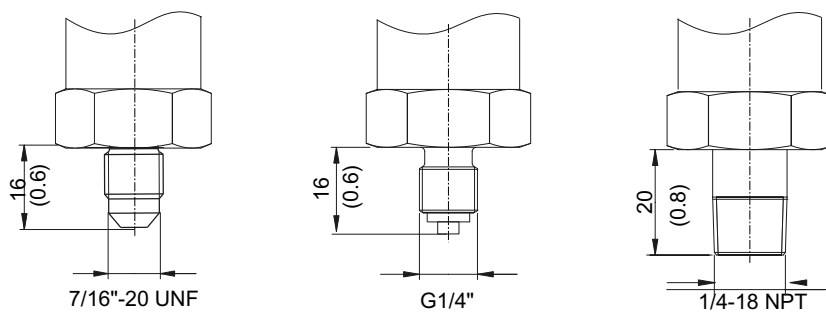

Figure 9-2 Max. 20 Nm

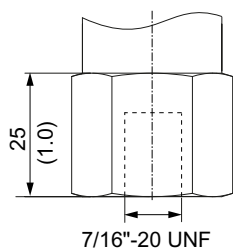

Figure 9-3 Max. 20 Nm

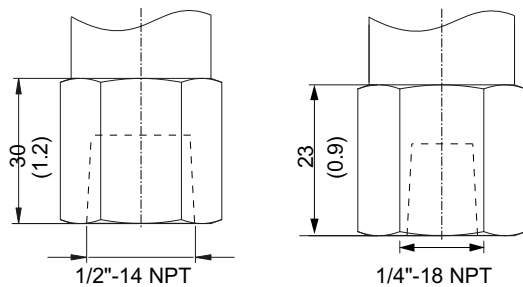

Figure 9-4 Max. 20 Nm; Pmax ≤ 60 bar

Product documentation and support

A.1 Product documentation

Process instrumentation product documentation is available in the following formats:

- Certificates (<http://www.siemens.com/processinstrumentation/certificates>)
- Downloads (firmware, EDDs, software) (<http://www.siemens.com/processinstrumentation/downloads>)
- Catalog and catalog sheets (<http://www.siemens.com/processinstrumentation/catalogs>)
- Manuals (<http://www.siemens.com/processinstrumentation/documentation>)
You have the option to show, open, save, or configure the manual.
 - "Display": Open the manual in HTML5 format
 - "Configure": Register and configure the documentation specific to your plant
 - "Download": Open or save the manual in PDF format
 - "Download as html5, only PC": Open or save the manual in the HTML5 view on your PC

You can also find manuals with the Mobile app at Industry Online Support (<https://support.industry.siemens.com/cs/ww/de/sc/2067>). Download the app to your mobile device and scan the device QR code.

Product documentation by serial number

Using the PIA Life Cycle Portal, you can access the serial number-specific product information including technical specifications, spare parts, calibration data, or factory certificates.

Entering a serial number

1. Open the PIA Life Cycle Portal (<https://www.pia-portal.automation.siemens.com>).
2. Select the desired language.
3. Enter the serial number of your device. The product documentation relevant for your device is displayed and can be downloaded.

To display factory certificates, if available, log in to the PIA Life Cycle Portal using your login or register.

Scanning a QR code

1. Scan the QR code on your device with a mobile device.
2. Click "PIA Portal".

To display factory certificates, if available, log in to the PIA Life Cycle Portal using your login or register.

A.2 Technical support

Technical support

If this documentation does not completely answer your technical questions, you can enter a Support Request (<http://www.siemens.com/automation/support-request>).

For help creating a support request, view this video here (www.siemens.com/opensr).

Additional information on our technical support can be found at Technical Support (<http://www.siemens.com/automation/csi/service>).

Service & support on the Internet

In addition to our technical support, Siemens offers comprehensive online services at Service & Support (<http://www.siemens.com/automation/serviceandsupport>).

Contact

If you have further questions about the device, contact your local Siemens representative at Personal Contact (<http://www.automation.siemens.com/partner>).

To find the contact for your product, go to "all products and branches" and select "Products & Services > Industrial automation > Process instrumentation".

Contact address for business unit:

Siemens AG
Digital Industries
Process Automation
Östliche Rheinbrückenstr. 50
76187 Karlsruhe, Germany

Index

C

Catalog
 catalog sheets, 31
Certificates, 7, 31
Conformity with UK directives, 8
Customer Support, (Refer to Technical support)

D

Disposal, 24
Downloads, 31

H

Hazardous area
 Laws and directives, 7
 Qualified personnel, 9
Hotline, (Refer to Support request)

L

Laws and directives
 Disassembly, 7
 Personel, 7

M

Manuals, 31
Modifications
 correct usage, 8
 improper, 8

Q

Qualified personnel, 9

R

Return procedure, 24

S

Scope of delivery, 5

Service, 32
Service and support
 Internet, 32
Support, 32
Support request, 32

T

Technical support, 32
 partner, 32
 personal contact, 32
Test certificates, 7

W

Warranty, 6

