

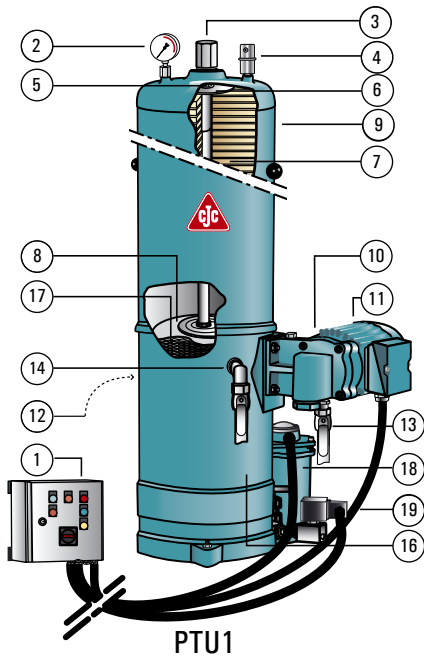

Filter Insert Replacement

CJC™ Filter Separator PTU 27/-



PTU1

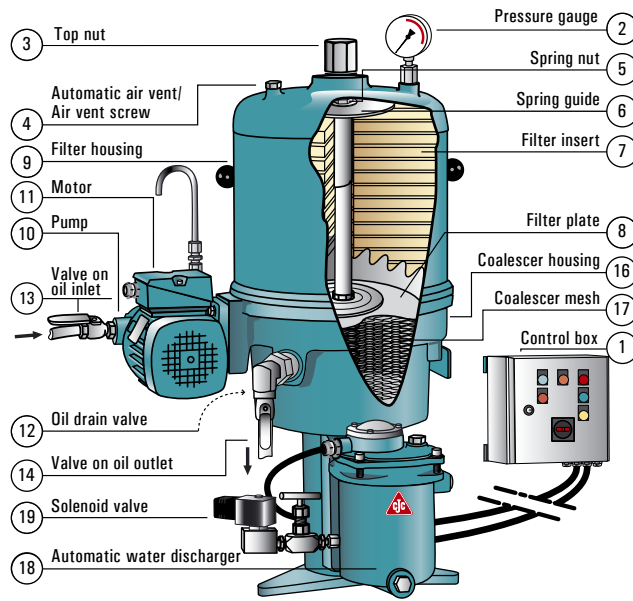

PTU2

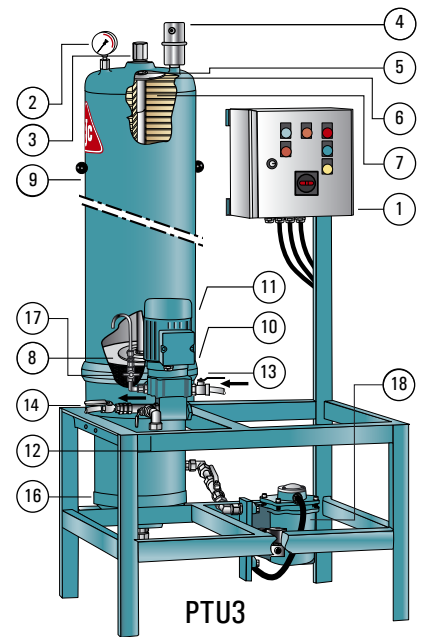

PTU3

FILTER INSERT REPLACEMENT

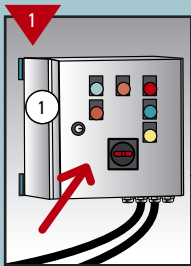

Stop CJC™ Filter

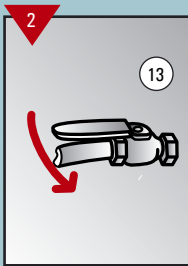

Close valve on oil inlet

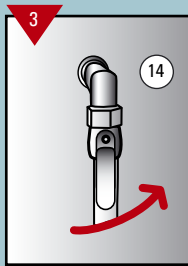

Close valve on oil outlet

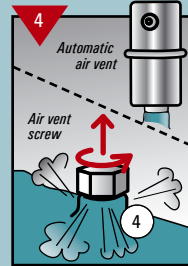

Automatic air vent: No action
Air vent screw: Open screw

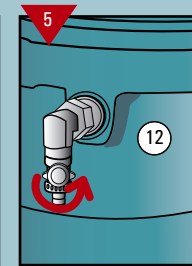

Open oil drain valve.
Drain acc. to environmental precautions!

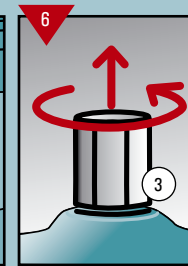

When filter housing is drained, unscrew top nut

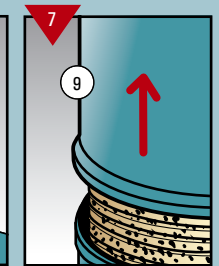

Lift off filter housing

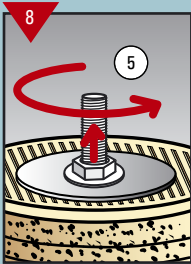

Unscrew spring nut

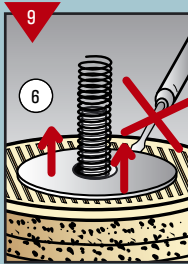

Remove spring and spring guide

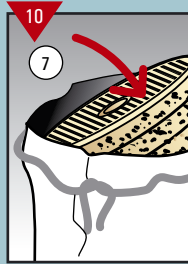

Remove used filter insert(s).
Deposit according to national legislation

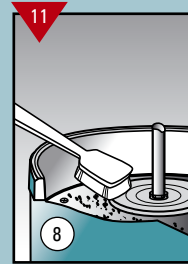

Clean filter plate

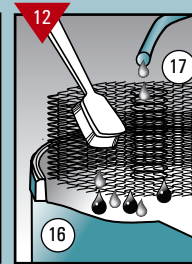

Remove mesh and clean in hot water. Do not use soap or detergents! Re-assemble

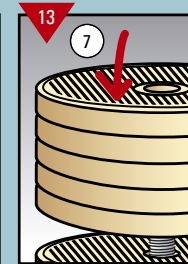

Place new CJC™ Filter Insert(s)

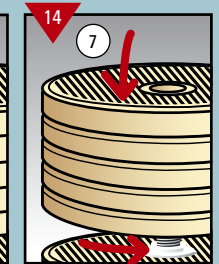

If > 1 insert type B, BLA or BLAT, use insert guide between filter inserts

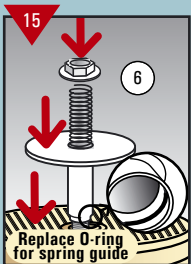

Mount spring guide carefully - make sure there is no contact between O-ring and thread

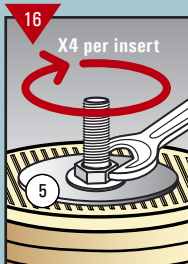

Tighten spring nut with hand until contact with spring guide. Then tighten spring nut 4 turns per filter insert

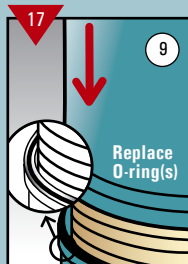

Replace O-ring and place filter housing. If type 27/108, replace both O-rings

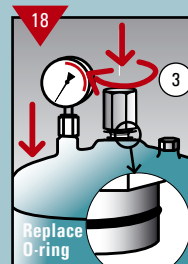

Place filter housing. Replace O-ring for top nut

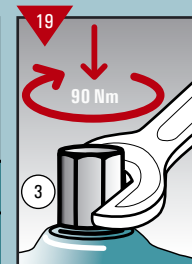

Tighten top nut with torque of 90 Nm

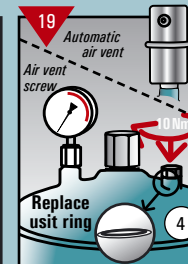

Automatic air vent: No action
Air vent screw: Replace usit ring, and tighten with torque of 10 Nm



Be aware that oil spillage is a serious safety risk - keep clean!

PF1202 - 11.11.2009