

Programming Guide

# VLT AutomationDrive FC 301/302

Software versions 9.12, 48.9X

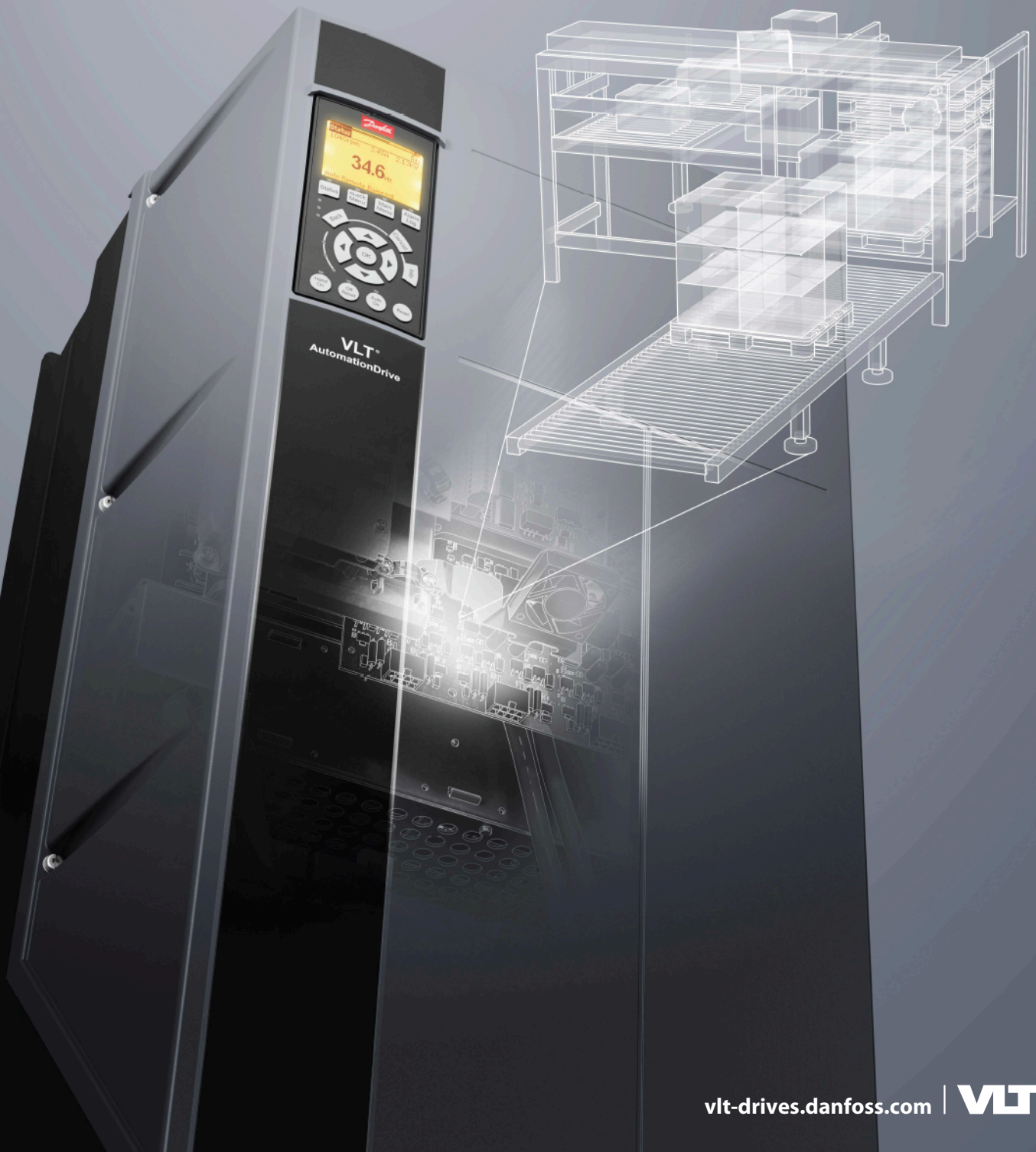



## Contents

|          |  |           |
|----------|--|-----------|
| <b>1</b> | <b>Introduction</b>  | <b>12</b> |
| 1.1      | Supported Software Versions                                  | 12        |
| 1.2      | Integrated Motion Controller                                 | 12        |
| <b>2</b> | <b>Safety</b>  | <b>13</b> |
| 2.1      | Safety Precautions   | 13        |
| 2.2      | Safety Regulations   | 14        |
| <b>3</b> | <b>Electrical Diagrams</b>                                   | <b>15</b> |
| 3.1      | Wiring Schematic   | 15        |
| 3.1.1    | Start/Stop   | 17        |
| 3.1.2    | Pulse Start/Stop   | 17        |
| 3.1.3    | Speed Up/Speed Down  | 18        |
| 3.1.4    | Potentiometer Reference                                      | 19        |
| <b>4</b> | <b>How to Program</b>  | <b>20</b> |
| 4.1      | Local Control Panel  | 20        |
| 4.1.1    | Quick Transfer of Parameter Settings between Multiple Drives | 21        |
| 4.1.1.1  | Transferring Data from the Drive to the LCP                  | 21        |
| 4.1.1.2  | Transferring Data from the LCP to the Drive                  | 21        |
| 4.1.2    | Display Mode   | 21        |
| 4.1.3    | Display Mode - Selection of Readouts                         | 21        |
| 4.1.3.1  | Status View I  | 24        |
| 4.1.3.2  | Status View II   | 24        |
| 4.1.3.3  | Status View III  | 24        |
| 4.1.4    | Parameter Setup  | 24        |
| 4.1.5    | Quick Menu Key Functions                                     | 25        |
| 4.1.6    | Initial Commissioning  | 26        |
| 4.1.7    | Main Menu Mode   | 28        |
| 4.1.8    | Parameter Selection  | 28        |
| 4.1.9    | Changing Data  | 28        |
| 4.1.10   | Changing a Text Value  | 28        |
| 4.1.11   | Changing a Data Value  | 29        |
| 4.1.12   | Infinitely Variable Change of Numeric Data Value             | 29        |
| 4.1.13   | Value, Step by Step  | 30        |
| 4.1.14   | Readout and Programming of Indexed Parameters                | 30        |
| 4.1.14.1 | Changing Values of Indexed Parameters                        | 30        |
| 4.2      | Numerical Local Control Panel                                | 30        |

|           |   |           |
|-----------|---|-----------|
| 4.2.1     | LCP Keys  | 31        |
| 4.3       | Restoring Factory Default Settings Using the Recommended Initialization | 33        |
| 4.4       | Restoring Factory Default Settings Using Manual Initialization          | 33        |
| <b>5</b>  | <b>Parameter Descriptions</b>   | <b>35</b> |
| 5.1       | Parameter Group 0-** Operation and Display                              | 35        |
| 5.1.1     | 0-0* Basic Settings   | 35        |
| 5.1.2     | 0-1* Set-up Operations  | 37        |
| 5.1.3     | 0-2* LCP Display  | 41        |
| 5.1.4     | 0-3* LCP Custom Readout   | 49        |
| 5.1.5     | 0-4* LCP Keypad   | 54        |
| 5.1.6     | 0-5* Copy/Save  | 56        |
| 5.1.7     | 0-6* Password   | 57        |
| 5.1.8     | 0-7* Clock Settings   | 59        |
| 5.2       | Parameter Group 1-** Load and Motor                                     | 62        |
| 5.2.1     | 1-0* General Settings   | 62        |
| 5.2.2     | Motor Setups  | 69        |
| 5.2.2.1   | Asynchronous Motor Setup  | 69        |
| 5.2.2.2   | PM Motor Setup  | 70        |
| 5.2.2.2.1 | PM Rotor Detection  | 70        |
| 5.2.2.2.2 | PM Parking  | 71        |
| 5.2.2.2.3 | Application-specific Adjustment when Running VVC+ with PM Motors        | 71        |
| 5.2.2.3   | SynRM Motor Setup with VVC+   | 71        |
| 5.2.2.3.1 | SynRM Initial Programming   | 71        |
| 5.2.2.3.2 | SynRM Programming Motor Data  | 71        |
| 5.2.2.3.3 | Application-specific Adjustment when Running VVC+ with SynRM Motors     | 72        |
| 5.2.3     | 1-1* Special Settings   | 72        |
| 5.2.4     | 1-2* Motor Data   | 75        |
| 5.2.5     | 1-3* Adv. Motor Data  | 81        |
| 5.2.6     | 1-5* Load Indep. Setting  | 88        |
| 5.2.7     | 1-6* Load Depend. Setting   | 92        |
| 5.2.8     | 1-7* Start Adjustments  | 95        |
| 5.2.9     | 1-8* Stop Adjustments   | 98        |
| 5.2.10    | 1-9* Motor Temperature  | 102       |
| 5.2.10.1  | PTC Thermistor Connection   | 107       |
| 5.2.10.2  | KTY Sensor Connection   | 108       |
| 5.2.10.3  | ETR   | 109       |
| 5.2.10.4  | ATEX ETR  | 109       |

|     |                                      |     |
|-----|--------------------------------------|-----|
|     | 5.2.10.5 Klixon                      | 110 |
|     | 5.2.10.6 PM Settings                 | 111 |
| 5.3 | Parameter Group 2-** Brakes          | 112 |
|     | 5.3.1 2-0* DC Brakes                 | 112 |
|     | 5.3.2 2-1* Brake Energy Funct.       | 114 |
|     | 5.3.3 2-2* Mechanical Brake          | 118 |
|     | 5.3.3.1 Hoist Mechanical Brake       | 121 |
|     | 5.3.4 2-3* Adv. Mech Brake           | 122 |
| 5.4 | Parameter Group 3-** Reference/Ramps | 123 |
|     | 5.4.1 3-0* Reference Limits          | 123 |
|     | 5.4.2 3-1* References                | 128 |
|     | 5.4.3 3-2* References II             | 136 |
|     | 5.4.4 3-3* Gen Ramp & Sync           | 138 |
|     | 5.4.5 3-4* Ramp 1                    | 142 |
|     | 5.4.6 3-5* Ramp 2                    | 145 |
|     | 5.4.7 3-6* Ramp 3                    | 146 |
|     | 5.4.8 3-7* Ramp 4                    | 148 |
|     | 5.4.9 3-8* Other Ramps               | 150 |
|     | 5.4.10 3-9* Digital Pot.Meter        | 152 |
| 5.5 | Parameter Group 4-** Limits/Warnings | 154 |
|     | 5.5.1 4-1* Motor Limits              | 154 |
|     | 5.5.2 4-2* Limit Factors             | 156 |
|     | 5.5.3 4-3* Motor Feedback Monitoring | 159 |
|     | 5.5.4 4-4* Speed Monitor             | 162 |
|     | 5.5.5 4-5* Adjustable Warnings       | 164 |
|     | 5.5.6 4-6* Speed Bypass              | 168 |
|     | 5.5.7 4-7* Position Monitor          | 169 |
|     | 5.5.8 4-8* Power Limit               | 172 |
|     | 5.5.9 4-9* Directional Limits        | 173 |
| 5.6 | Parameter Group 5-** Digital In/Out  | 175 |
|     | 5.6.1 5-0* Digital I/O Mode          | 175 |
|     | 5.6.2 5-1* Digital Inputs            | 176 |
|     | 5.6.3 5-3* Digital Outputs           | 198 |
|     | 5.6.4 5-4* Relays                    | 209 |
|     | 5.6.5 5-5* Pulse Input               | 217 |
|     | 5.6.6 5-6* Pulse Outputs             | 220 |
|     | 5.6.7 5-7* 24 V Encoder Input        | 225 |
|     | 5.6.8 5-8* I/O Options               | 228 |

|        |   |     |
|--------|---|-----|
| 5.6.9  | 5-9* Bus-controlled                             | 229 |
| 5.7    | Parameter Group 6-** Analog In/Out              | 231 |
| 5.7.1  | 6-0* Analog I/O Mode                            | 231 |
| 5.7.2  | 6-1* Analog Input 1                             | 232 |
| 5.7.3  | 6-2* Analog Input 2                             | 234 |
| 5.7.4  | 6-3* Analog Input 3 General Purpose I/O MCB 101 | 236 |
| 5.7.5  | 6-4* Analog Input X30/12                        | 237 |
| 5.7.6  | 6-5* Analog Output 1                            | 238 |
| 5.7.7  | 6-6* Analog Output 2 MCB 101                    | 242 |
| 5.7.8  | 6-7* Analog Output 3 MCB 113                    | 246 |
| 5.7.9  | 6-8* Analog Output 4 MCB 113                    | 249 |
| 5.8    | Parameter Group 7-** Controllers                | 253 |
| 5.8.1  | Speed PID Droop                                 | 253 |
| 5.8.2  | Speed Trim                                      | 254 |
| 5.8.3  | 7-0* Speed PID Ctrl.                            | 255 |
| 5.8.4  | 7-1* Torque PI Control                          | 259 |
| 5.8.5  | 7-2* Process Ctrl. Feedb.                       | 260 |
| 5.8.6  | 7-3* Process PID Ctrl.                          | 262 |
| 5.8.7  | 7-4* Advanced Process PID Ctrl.                 | 264 |
| 5.8.8  | 7-5* Ext. Process PID Ctrl.                     | 266 |
| 5.8.9  | 7-9* Position PI Ctrl.                          | 268 |
| 5.9    | Parameter Group 8-** Communications and Options | 271 |
| 5.9.1  | 8-0* General Settings                           | 271 |
| 5.9.2  | 8-1* Ctrl. Word Settings                        | 275 |
| 5.9.3  | 8-2* Counters                                   | 287 |
| 5.9.4  | 8-3* FC Port Settings                           | 287 |
| 5.9.5  | 8-4* FC MC Protocol Set                         | 289 |
| 5.9.6  | 8-5* Digital/Bus                                | 298 |
| 5.9.7  | 8-8* FC Port Diagnostics                        | 302 |
| 5.9.8  | 8-9* Bus Jog                                    | 303 |
| 5.10   | Parameter Group 9-** PROFIBUS                   | 303 |
| 5.11   | Parameter Group 10-** CAN Fieldbus              | 327 |
| 5.11.1 | 10-0* Common Settings                           | 327 |
| 5.11.2 | 10-1* DeviceNet                                 | 328 |
| 5.11.3 | 10-2* COS Filters                               | 338 |
| 5.11.4 | 10-3* Parameter Access                          | 339 |
| 5.11.5 | 10-5* CANopen                                   | 340 |
| 5.12   | Parameter Group 12-** Ethernet                  | 348 |

|         |  |     |
|---------|--|-----|
| 5.12.1  | 12-0* IP Settings                          | 348 |
| 5.12.2  | 12-1* Ethernet Link Parameters             | 350 |
| 5.12.3  | 12-2* Process Data                         | 351 |
| 5.12.4  | 12-3* EtherNet/IP                          | 361 |
| 5.12.5  | 12-4* Modbus TCP                           | 363 |
| 5.12.6  | 12-4* Fieldbus Extension                   | 364 |
| 5.12.7  | 12-5* EtherCAT                             | 364 |
| 5.12.8  | 12-6* Ethernet POWERLINK                   | 366 |
| 5.12.9  | 12-8* Other Ethernet Services              | 367 |
| 5.12.10 | 12-9* Advanced Ethernet Services           | 369 |
| 5.13    | Parameter Group 13-*** Smart Logic Control | 372 |
| 5.13.1  | 13-0* SLC Settings                         | 373 |
| 5.13.2  | 13-1* Comparators                          | 381 |
|         | 5.13.2.1 RS FlipFlops                      | 388 |
| 5.13.3  | 13-2* Timers                               | 398 |
| 5.13.4  | 13-4* Logic Rules                          | 398 |
| 5.13.5  | 13-5* States                               | 413 |
| 5.13.6  | 13-9* User-defined Alerts and Readouts     | 445 |
| 5.14    | Parameter Group 14-*** Special Functions   | 450 |
| 5.14.1  | 14-0* Inverter Switching                   | 450 |
| 5.14.2  | 14-1* Mains On/Off                         | 453 |
| 5.14.3  | 14-2* Trip Reset                           | 459 |
| 5.14.4  | 14-3* Current Limit Control                | 462 |
| 5.14.5  | 14-4* Energy Optimizing                    | 465 |
| 5.14.6  | 14-5* Environment                          | 467 |
| 5.14.7  | 14-6* Auto Derate                          | 472 |
| 5.14.8  | 14-7* Compatibility                        | 474 |
| 5.14.9  | 14-8* Options                              | 474 |
| 5.14.10 | 14-9* Fault Settings                       | 475 |
| 5.15    | Parameter Group 15-*** Drive Information   | 477 |
| 5.15.1  | 15-0* Operating Data                       | 477 |
| 5.15.2  | 15-1* Data Log Settings                    | 479 |
| 5.15.3  | Service Log                                | 484 |
| 5.15.4  | Clearing the Service Log                   | 485 |
| 5.15.5  | Service Log Indication                     | 485 |
| 5.15.6  | Reading the Service Log Information        | 485 |
| 5.15.7  | Alarms that Trigger a Service Log Record   | 486 |
| 5.15.8  | 15-2* Historic Log                         | 487 |

|         |  |     |
|---------|--|-----|
| 5.15.9  | 15-3* Alarm Log                              | 488 |
| 5.15.10 | 15-4* Drive Identification                   | 489 |
| 5.15.11 | 15-6* Option Ident.                          | 492 |
| 5.15.12 | 15-8* Operating Data II                      | 494 |
| 5.15.13 | 15-9* Parameter Info                         | 495 |
| 5.16    | Parameter Group 16-** Data Readouts          | 496 |
| 5.16.1  | 16-0* General Status                         | 496 |
| 5.16.2  | 16-1* Motor Status                           | 498 |
| 5.16.3  | 16-3* Drive Status                           | 501 |
| 5.16.4  | 16-5* Ref. & Feedb.                          | 506 |
| 5.16.5  | 16-6* Inputs and Outputs                     | 507 |
| 5.16.6  | 16-8* Fieldbus & FC Port                     | 512 |
| 5.16.7  | 16-9* Diagnosis Readouts                     | 513 |
| 5.17    | Parameter Group 17-** Feedback               | 516 |
| 5.17.1  | 17-0* Encoder Interface                      | 517 |
| 5.17.2  | 17-1* Inc. Enc. Interface                    | 517 |
| 5.17.3  | 17-2* Abs. Enc. Interface                    | 518 |
| 5.17.4  | 17-4* Fieldbus Reference 2                   | 520 |
| 5.17.5  | 17-5* Resolver Interface                     | 521 |
| 5.17.6  | 17-6* Monitoring and Application             | 523 |
| 5.17.7  | 17-7* Position Scaling                       | 525 |
| 5.17.8  | 17-8* Position Homing                        | 529 |
| 5.17.9  | 17-9* Position Configuration                 | 534 |
| 5.18    | Parameter Group 18-** Data Readouts 2        | 537 |
| 5.18.1  | 18-0* Maintenance Log                        | 537 |
| 5.18.2  | 18-1* Emergency Mode Log                     | 539 |
| 5.18.3  | 18-1* Parameter Log                          | 539 |
| 5.18.4  | 18-2* Motor Readouts                         | 541 |
| 5.18.5  | 18-3* Analog Input                           | 543 |
| 5.18.6  | 18-4* PGIO Data Readouts                     | 544 |
| 5.18.7  | 18-5* Active Alarms/Warnings                 | 545 |
| 5.18.8  | 18-6* Inputs & Outputs 2                     | 546 |
| 5.18.9  | 18-7* Rectifier Status                       | 546 |
| 5.18.10 | 18-9* PID Readouts                           | 549 |
| 5.19    | Parameter Group 19-** Application Parameters | 550 |
| 5.20    | Parameter Group 22-** Appl. Functions        | 550 |
| 5.20.1  | 22-0* Miscellaneous                          | 550 |
| 5.21    | Parameter Group 23-** Time-based Functions   | 551 |



|        |   |     |
|--------|---|-----|
| 5.21.1 | 23-0* Timed Actions                           | 551 |
| 5.21.2 | 23-1* Maintenance                             | 557 |
| 5.22   | Parameter Group 24-** Application Functions 2 | 562 |
| 5.22.1 | 24-0* Emergency Mode                          | 562 |
| 5.22.2 | 24-1* Drive Bypass                            | 570 |
| 5.22.3 | 24-4* Emergency Mode 2                        | 571 |
| 5.22.4 | 24-9* Multi-Motor Funct.                      | 573 |
| 5.23   | Parameter Group 30-** Special Features        | 575 |
| 5.23.1 | 30-0* Wobble Function                         | 575 |
| 5.23.2 | 30-2* Adv. Start Adjust                       | 579 |
| 5.23.3 | 30-5* Unit Configuration                      | 582 |
| 5.23.4 | 30-7* Power Low Monitor Protection            | 582 |
| 5.23.5 | 30-8* Compatibility (I)                       | 583 |
| 5.23.6 | 30-9* Wifi LCP                                | 584 |
| 5.24   | Parameter Group 31-** Bypass Option           | 586 |
| 5.25   | Parameter Group 32-** MCO Basic Settings      | 587 |
| 5.25.1 | 32-0* Encoder 2                               | 588 |
| 5.25.2 | 32-3* Encoder 1                               | 592 |
| 5.25.3 | 32-5* Feedback Source                         | 595 |
| 5.25.4 | 32-6* PID Controller                          | 596 |
| 5.25.5 | 32-8* Velocity & Accel.                       | 599 |
| 5.25.6 | 32-9* Development                             | 601 |
| 5.26   | Parameter Group 33-** MCO Adv. Settings       | 601 |
| 5.26.1 | 33-0* Home Motion                             | 601 |
| 5.26.2 | 33-1* Synchronization                         | 602 |
| 5.26.3 | 33-4* Limit Handling                          | 607 |
| 5.26.4 | 33-5* I/O Configuration                       | 609 |
| 5.26.5 | 33-8* Global Parameters                       | 620 |
| 5.26.6 | 33-9* MCO Port Settings                       | 623 |
| 5.27   | Parameter Group 34-** MCO Data Readouts       | 624 |
| 5.27.1 | 34-0* PCD Write Par.                          | 624 |
| 5.27.2 | 34-2* PCD Read Par.                           | 626 |
| 5.27.3 | 34-4* Inputs & Outputs                        | 627 |
| 5.27.4 | 34-5* Process Data                            | 628 |
| 5.27.5 | 34-7* Diagnosis Readouts                      | 630 |
| 5.28   | Parameter Group 35-** Sensor Input Option     | 630 |
| 5.28.1 | 35-0* Temp. Input Mode                        | 630 |
| 5.28.2 | 35-1* Temp. Input X48/4                       | 633 |

|          |   |            |
|----------|---|------------|
| 5.28.3   | 35-2* Temp. Input X48/7                       | 634        |
| 5.28.4   | 35-3* Temp. Input X48/10                      | 634        |
| 5.28.5   | 35-4* Analog Input X48/2                      | 635        |
| 5.29     | Parameter Group 36-** Programmable I/O Option | 636        |
| 5.29.1   | 36-0* I/O Mode                                | 636        |
| 5.29.2   | 36-1* Analog Input X49/1                      | 639        |
| 5.29.3   | 36-2* Analog Input X49/3                      | 640        |
| 5.29.4   | 36-3* Analog Input X49/5                      | 641        |
| 5.29.5   | 36-4* Output X49/7                            | 643        |
| 5.29.6   | 36-5* Output X49/9                            | 649        |
| 5.29.7   | 36-6* Output X49/11                           | 655        |
| 5.30     | Parameter Group 40-** Special Settings        | 662        |
| 5.30.1   | 40-1* Aux. Functions Control                  | 662        |
| 5.30.2   | 40-2* PM Motor Specific                       | 663        |
| 5.30.3   | 40-4* Extend. Fault Log                       | 664        |
| 5.30.4   | 40-5* Advanced Control Settings               | 665        |
| 5.31     | Parameter Group 42-** Safety Functions        | 668        |
| 5.31.1   | 42-0* Speed Performance                       | 668        |
| 5.31.2   | 42-1* Speed Monitoring                        | 668        |
| 5.31.3   | 42-2* Safe Input                              | 670        |
| 5.31.4   | 42-3* General                                 | 672        |
| 5.31.5   | 42-4* SS1                                     | 673        |
| 5.31.6   | 42-5* SLS                                     | 675        |
| 5.31.7   | 42-7* SMS                                     | 676        |
| 5.31.8   | 42-8* Status                                  | 676        |
| 5.32     | Parameter Group 43-** Unit Readouts           | 677        |
| 5.32.1   | 43-0* Component Status                        | 677        |
| 5.32.2   | 43-1* Power Card Status                       | 678        |
| 5.32.3   | 43-2* Fan Pow.Card Status                     | 680        |
| 5.33     | Parameter Group 50-** License                 | 681        |
| 5.34     | Parameter Group 600-** PROFIsafe              | 682        |
| 5.35     | Parameter Group 601-** PROFIdrive 2           | 682        |
| <b>6</b> | <b>Integrated Motion Controller</b>           | <b>683</b> |
| 6.1      | Introduction                                  | 683        |
| 6.2      | Positioning, Homing, and Synchronization      | 683        |
| 6.2.1    | Positioning                                   | 683        |
| 6.2.2    | Homing  | 684        |

---

|          |  |            |
|----------|--|------------|
| 6.2.3    | Synchronization                                    | 684        |
| 6.2.4    | Fieldbus References                                | 685        |
| 6.3      | Control  | 686        |
| 6.3.1    | Control Loops                                      | 686        |
| 6.3.2    | Control and Status Signals                         | 686        |
| <b>7</b> | <b>Troubleshooting</b>                             | <b>691</b> |
| 7.1      | Status Messages                                    | 691        |
| 7.1.1    | Warnings and Alarms                                | 691        |
| 7.1.2    | Alarm/Warning Code List                            | 691        |
| 7.1.3    | Indicator Light                                    | 695        |
| 7.1.4    | Alarm Word, Warning Word, and Extended Status Word | 695        |
| 7.2      | Descriptions of Warnings and Alarms                | 700        |

---

## 1 Introduction

### 1.1 Supported Software Versions

**Supported software versions: 9.12 and 48.9X**

This programming guide can be used for all FC 301 and FC 302 drives, and for VLT® Decentral Drive FCD 302. The software version number can be read from *parameter 15-43 Software Version*.

### 1.2 Integrated Motion Controller

The integrated motion controller (IMC) enables position control. For more information about IMC, refer to the *Chapter Integrated Motion Controller*.

## 2 Safety

### 2.1 Safety Precautions

#### ⚠ WARNING ⚠

##### LACK OF SAFETY AWARENESS

This guide provides important information on preventing injury and damage to the equipment or the system. Ignoring this information can lead to death, serious injury, or severe damage to the equipment.

- Make sure to fully understand the dangers and safety measures present in the application.
- Before performing any electrical work on the drive, lock out and tag out all power sources to the drive.

#### ⚠ WARNING ⚠

##### HAZARDOUS VOLTAGE

AC drives contain hazardous voltage when connected to AC mains or connected on the DC terminals. Failure to perform installation, start-up, and maintenance by qualified personnel can result in death or serious injury.

- Only qualified personnel must perform installation, start-up, and maintenance.

#### ⚠ WARNING ⚠

##### UNINTENDED START

When the drive is connected to AC mains, DC supply, or load sharing, the motor may start at any time, causing risk of death, serious injury, and equipment or property damage. The motor may start by activation of an external switch, a fieldbus command, an input reference signal from the LCP or LOP, via remote operation using MCT 10 Set-up software, or after a cleared fault condition.

- Press [Off] on the LCP before programming parameters.
- Disconnect the drive from the mains whenever personal safety considerations make it necessary to avoid unintended motor start.
- Check that the drive, motor, and any driven equipment are in operational readiness.

#### ⚠ WARNING ⚠

##### DISCHARGE TIME

The drive contains DC-link capacitors, which can remain charged even when the drive is not powered. High voltage can be present even when the warning indicator lights are off. Failure to wait the specified time after power has been removed before performing service or repair work can result in death or serious injury.

- Stop the motor.
- Disconnect all power sources, including permanent magnet type motors.
- Wait for capacitors to discharge fully. The discharge time is shown on the nameplate.
- Verify full discharge by measuring the voltage level.

## ⚠ WARNING ⚠

### DISCHARGE TIME

The drive contains DC-link capacitors, which can remain charged even when the drive is not powered. High voltage can be present even when the warning indicator lights are off. Failure to wait the specified time after power has been removed before performing service or repair work can result in death or serious injury.

- Stop the motor.
- Disconnect all power sources, including permanent magnet type motors.
- Wait for capacitors to discharge fully. The discharge time is shown on the nameplate.
- Verify full discharge by measuring the voltage level.

## N O T I C E

### USING THE SAFE TORQUE OFF

- When using the Safe Torque Off, always follow the instructions in VLT® Frequency Converters - Safe Torque Off Operating Instructions.

## N O T I C E

### CONTROL SIGNALS

- Control signals from, or internally within, the drive may in rare cases be activated in error, be delayed, or fail to occur entirely. When used in situations where safety is critical, for example when controlling the electromagnetic brake function of a hoist application, do not rely on these control signals exclusively.

## N O T I C E

### HAZARDOUS SITUATIONS

- Hazardous situations must be identified by the machine builder/integrator who is responsible for considering the necessary preventive means. More monitoring and protective devices may be included, always according to valid national safety regulations, for example law on mechanical tools and regulations for the prevention of accidents.

## 2.2 Safety Regulations

### Crane, lifts, and hoists

The controlling of external brakes must always have a redundant system. The drive can in no circumstances be the primary safety circuit. Comply with relevant standards, for example:

- Hoists and cranes: IEC 60204-32
- Lifts: EN 81

### Protection mode

Once a hardware limit on motor current or DC-link voltage is exceeded, the drive enters protection mode. Protection mode means a change of the PWM modulation strategy and a low switching frequency to minimize losses. This continues for 10 s after the last fault and increases the reliability and robustness of the drive while re-establishing full control of the motor.

In hoist applications, protection mode is not usable because the drive is unable to leave this mode again. Therefore it extends the time before activating the brake, which is not recommended. Protection mode can be disabled by setting *parameter 14-26 Trip Delay at Inverter Fault* to 0, which means that the drive trips immediately if 1 of the hardware limits is exceeded.

## N O T I C E

Disabling protection mode in hoisting applications is recommended.

### 3 Electrical Diagrams

#### 3.1 Wiring Schematic

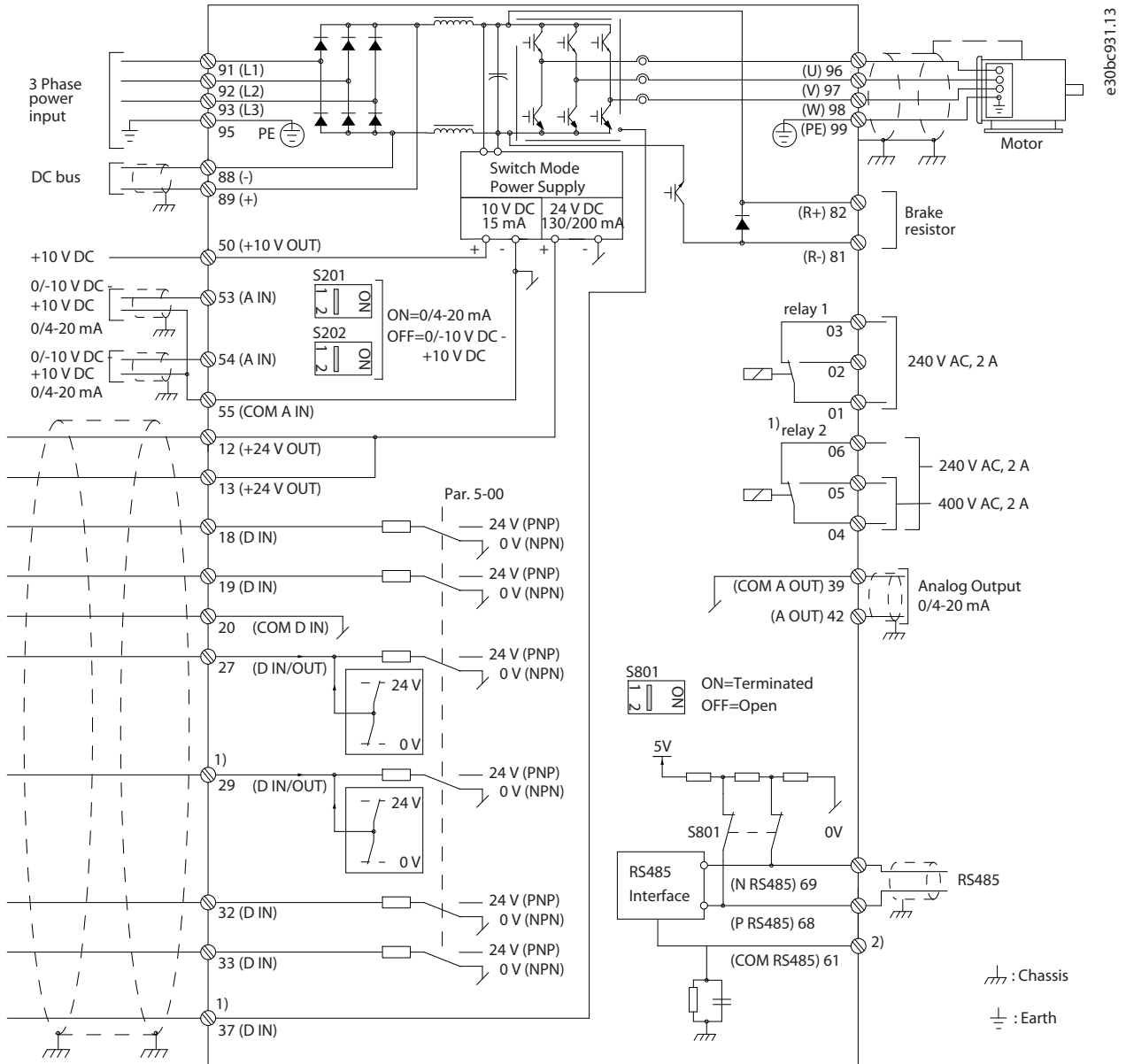

Illustration 1: Wiring Schematic

A=Analog, D=Digital

1) Do not connect cable shield.

Terminal 37 is used for Safe Torque Off (STO). For STO installation instructions, refer to the VLT® Frequency Converters - Safe Torque Off Operating Guide.

Long control cables and analog signals may in rare cases, depending on installation, result in 50/60 Hz ground loops due to noise from mains supply cables. If 50/60 Hz ground loops occur, consider breaking the shield or insert a 100 nF capacitor between shield and enclosure.

To avoid ground currents from both groups to affect other groups, connect the digital and analog inputs and outputs separately to the common inputs (terminals 20, 55, and 39) of the drive. For example, switching on the digital input may disturb the analog input signal.

Input polarity of control terminals

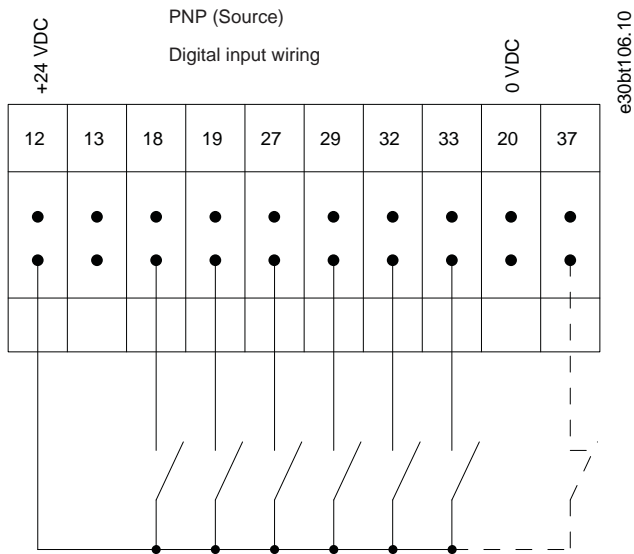

Illustration 2: PNP (Source)

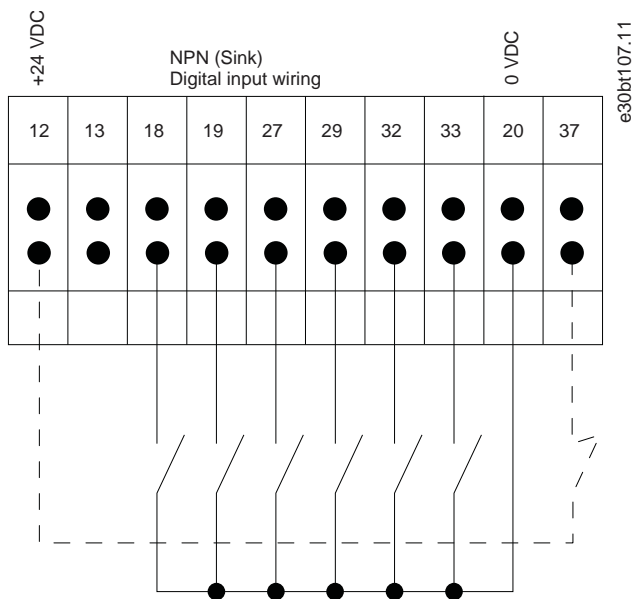
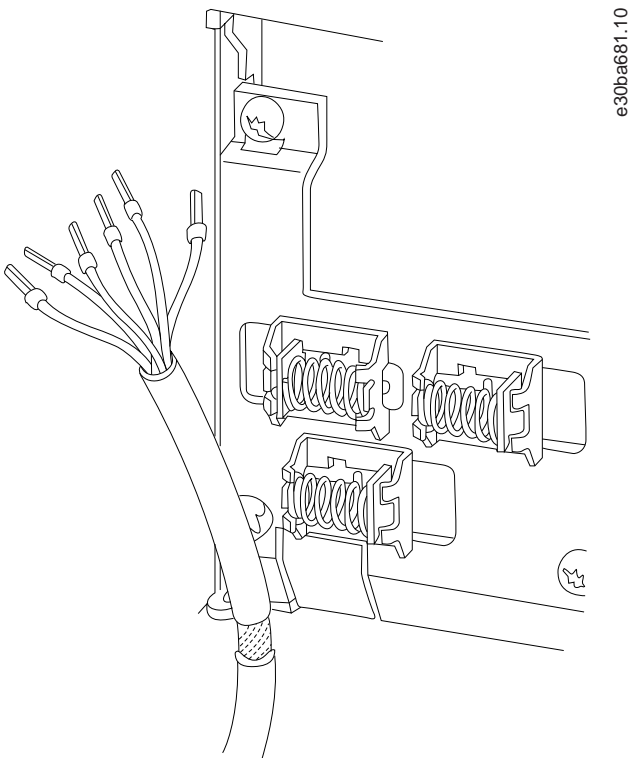

Illustration 3: NPN (Sink)

**NOTICE**

Control cables must be shielded/armored.





e30ba681.10

Illustration 4: Grounding of Shielded/Armored Control Cables

### 3.1.1 Start/Stop

Terminal 18 = Parameter 5-10 Terminal 18 Digital Input [8] Start.

Terminal 27 = Parameter 5-12 Terminal 27 Digital Input [0] No operation (Default [2] Coast inverse).

Terminal 37 = Safe Torque Off.

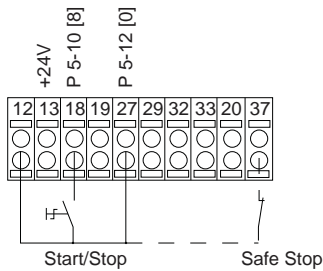

e30ba155.12

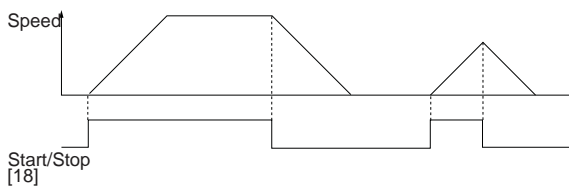

Illustration 5: Start/Stop

### 3.1.2 Pulse Start/Stop

Terminal 18 = Parameter 5-10 Terminal 18 Digital Input [9] Latched start.

Terminal 27 = Parameter 5-12 Terminal 27 Digital Input [6] Stop inverse.

Terminal 37 = Safe Torque Off.

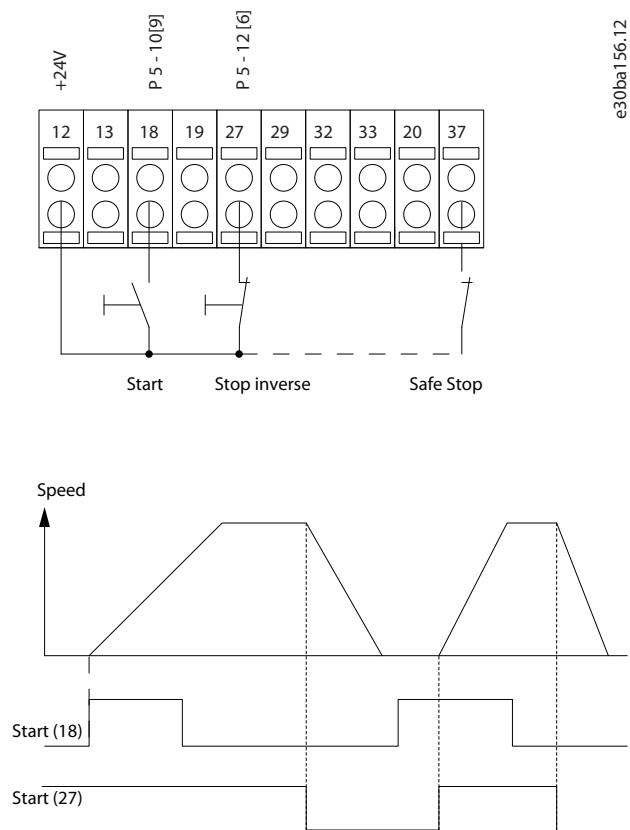

Illustration 6: Pulse Start/Stop

### 3.1.3 Speed Up/Speed Down

- Terminal 18 = Parameter 5-10 Terminal 18 Digital Input [8] Start.
- Terminal 27 = Parameter 5-12 Terminal 27 Digital Input [19] Freeze reference.
- Terminal 37 = Safe Torque Off.
- Terminal 29 = Parameter 5-13 Terminal 29 Digital Input [21] Speed up.
- Terminal 32 = Parameter 5-14 Terminal 32 Digital Input [22] Speed down.

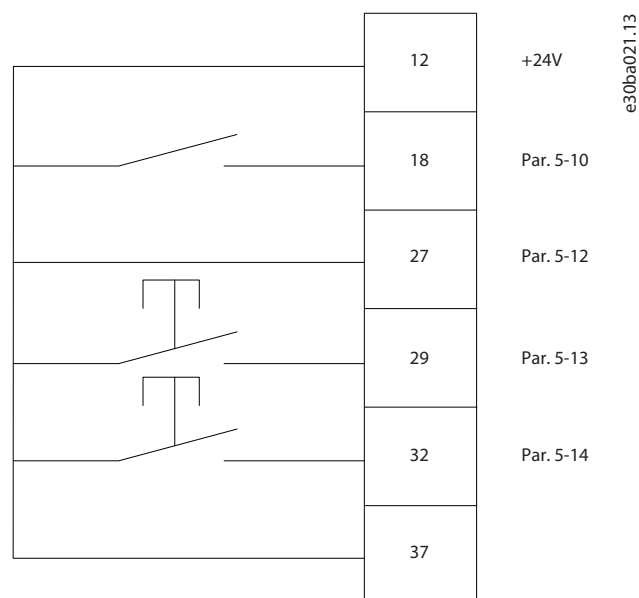

Illustration 7: Speed Up/Speed Down

### 3.1.4 Potentiometer Reference

#### Voltage reference via a potentiometer

Reference source 1 = [1] Analog input 53 (default).

Terminal 53, low voltage = 0 V.

Terminal 53, high voltage = 10 V.

Terminal 53, low reference/feedback = 0 RPM.

Terminal 53, high reference/feedback = 1500 RPM.

Switch S201 = OFF (U)

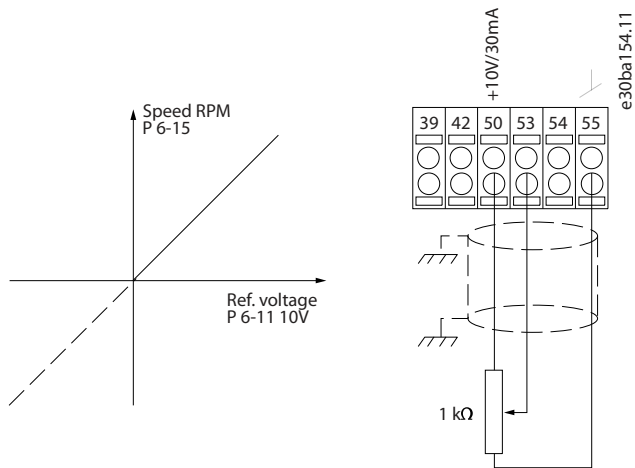

Illustration 8: Potentiometer Reference

## 4 How to Program

### 4.1 Local Control Panel

Easily program the drive via the local control panel (LCP).

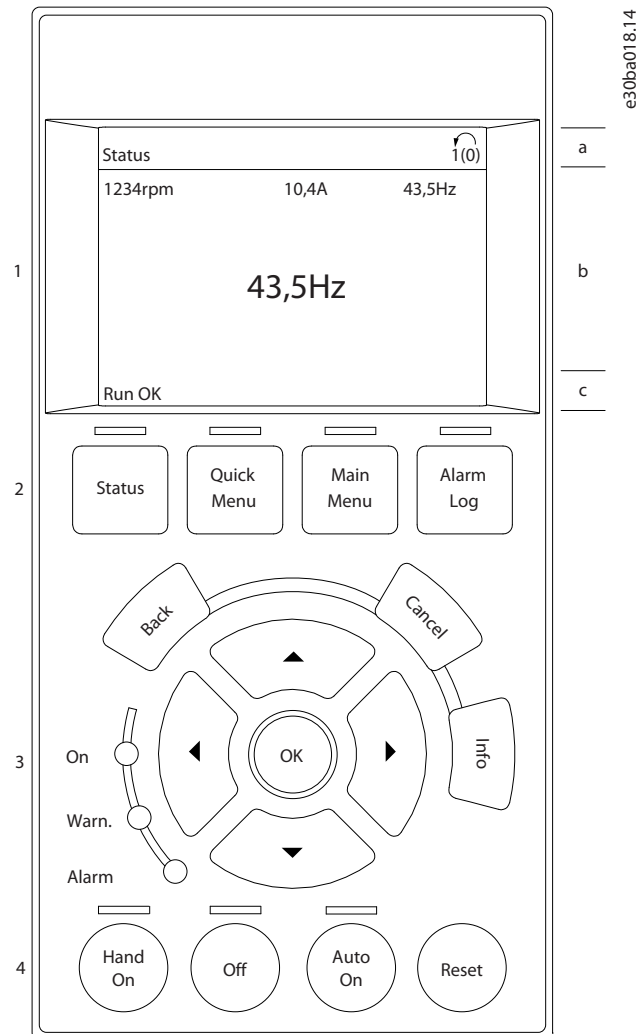

Illustration 9: LCP

|   |   |
|---|---|
| <p>1 Graphical display with status lines.</p>   | <p>a Status line: Status messages showing icons and graphics.</p>   |
| <p>2 Menu keys and indicator lights - changing parameters and switching between display function.</p> | <p>b Line 1–2: Operator data lines showing data defined or selected. Add up to 1 extra line by pressing [Status].</p> |
| <p>3 Navigation keys and indicator lights.</p>  |   |
| <p>4 Operation keys and indicator lights.</p>   | <p>c Status line: Status messages showing text.</p>   |

The LCP display can show up to 5 items of operating data while showing *Status*.

## NOTICE

If start-up is delayed, the LCP shows the INITIALIZING message until it is ready. Adding or removing options can delay the start-up.

### 4.1.1 Quick Transfer of Parameter Settings between Multiple Drives

When the setup of a drive is completed, store the data in the LCP. Then connect the LCP to another drive and copy the parameter settings to the new drive.

#### 4.1.1.1 Transferring Data from the Drive to the LCP

##### Procedure

1. Go to *parameter 0-50 LCP Copy*.
2. Press [OK].
3. Select [1] *All to LCP*.
4. Press [OK].

#### 4.1.1.2 Transferring Data from the LCP to the Drive

##### Procedure

1. Go to *parameter 0-50 LCP Copy*.
2. Press [OK].
3. Select [2] *All from LCP*.
4. Press [OK].

### 4.1.2 Display Mode

In normal operation, up to 5 different operating variables can be indicated continuously in the middle section: 1.1, 1.2, and 1.3, as well as 2 and 3.

#### 4.1.3 Display Mode - Selection of Readouts

It is possible to toggle between 3 status readout screens by pressing [Status].

Operating variables with different formatting are shown in each status view (status view I, status view II, status view III).

The following table shows the measurements that can be linked to each of the operating variables. When options are mounted, additional measurements are available.

Define the links via:

- *Parameter 0-20 Display Line 1.1 Small.*
- *Parameter 0-21 Display Line 1.2 Small.*
- *Parameter 0-22 Display Line 1.3 Small.*
- *Parameter 0-23 Display Line 2 Large.*
- *Parameter 0-24 Display Line 3 Large.*

Each readout parameter selected in *parameter 0-20 Display Line 1.1 Small* to *parameter 0-24 Display Line 3 Large* has its own scale and digits after a possible decimal point. The larger the numeric value of a parameter is, the fewer digits are shown after the decimal point.

Example: Current readout 5.25 A, 15.2 A, 105 A.

Table 1: Units

| Operating variable                           | Unit   |
|--|--------|
| <i>Parameter 16-00 Control Word</i>          | hex    |
| <i>Parameter 16-01 Reference [Unit]</i>      | [Unit] |
| <i>Parameter 16-02 Reference [%]</i>         | %      |
| <i>Parameter 16-03 Status Word</i>           | hex    |
| <i>Parameter 16-05 Main Actual Value [%]</i> | %      |
| <i>Parameter 16-06 Actual Position</i>       |        |
| <i>Parameter 16-09 Custom Readout</i>        |        |
| <i>Parameter 16-10 Power [kW]</i>            | [kW]   |

| Operating variable  | Unit               |
|---|--------------------|
| Parameter 16-11 Power [hp]  | [hp]               |
| Parameter 16-12 Motor Voltage   | [V]                |
| Parameter 16-13 Frequency   | [Hz]               |
| Parameter 16-14 Motor current   | [A]                |
| Parameter 16-15 Frequency [%]   | %                  |
| Parameter 16-16 Torque [Nm]   | Nm                 |
| Parameter 16-17 Speed [RPM]   | [RPM]              |
| Parameter 16-18 Motor Thermal   | %                  |
| Parameter 16-20 Motor Angle   |                    |
| Parameter 16-21 Torque [%] High Res.  | %                  |
| Parameter 16-22 Torque [%]  | %                  |
| Parameter 16-23 Motor Shaft Power [kW]  | kW                 |
| Parameter 16-24 Calibrated Stator Resistance  | $\Omega$           |
| Parameter 16-25 Torque [Nm] High  | Nm                 |
| Parameter 16-30 DC Link Voltage   | V                  |
| Parameter 16-32 Brake Energy /s   | kW                 |
| Parameter 16-33 Brake Energy Average  | kW                 |
| Parameter 16-34 Heatsink Temp.  | $^{\circ}\text{C}$ |
| Parameter 16-35 Inverter Thermal  | %                  |
| Parameter 16-36 Inv. Nom. Current   | A                  |
| Parameter 16-37 Inv. Max. Current   | A                  |
| Parameter 16-38 SL Controller State (This is an array parameter with the selections 16-38.0–16-38.3). |                    |
| Parameter 16-39 Control Card Temp.  | $^{\circ}\text{C}$ |
| Parameter 16-40 Logging Buffer Full   |                    |
| Parameter 16-42 Service Log Counter   |                    |
| Parameter 16-43 Timed Actions Status  |                    |
| Parameter 16-45 Motor Phase U Current   | A                  |
| Parameter 16-46 Motor Phase V Current   | A                  |
| Parameter 16-47 Motor Phase W Current   | A                  |
| Parameter 16-48 Speed Ref. After Ramp [RPM]   | RPM                |
| Parameter 16-49 Current Fault Source  |                    |
| Parameter 16-50 External Reference  |                    |

| Operating variable   | Unit   |
|--|--------|
| <i>Parameter 16-51 Pulse Reference</i>   |        |
| <i>Parameter 16-52 Feedback[Unit]</i>  | [Unit] |
| <i>Parameter 16-53 Digi Pot Reference</i>  |        |
| <i>Parameter 16-57 Feedback [RPM]</i>  | RPM    |
| <i>Parameter 16-60 Digital Input</i>   | bin    |
| <i>Parameter 16-61 Terminal 53 Switch Setting</i>  | V      |
| <i>Parameter 16-62 Analog Input 53</i>   |        |
| <i>Parameter 16-63 Terminal 54 Switch Setting</i>  | V      |
| <i>Parameter 16-64 Analog Input 54</i>   |        |
| <i>Parameter 16-65 Analog Output 42 [mA]</i>   | [mA]   |
| <i>Parameter 16-66 Digital Output [bin]</i>  | [bin]  |
| <i>Parameter 16-67 Pulse Input #29 [Hz]</i>  | [Hz]   |
| <i>Parameter 16-68 Freq. Input #33 [Hz]</i>  | [Hz]   |
| <i>Parameter 16-69 Pulse Output #27 [Hz]</i>   | [Hz]   |
| <i>Parameter 16-70 Pulse Output #29 [Hz]</i>   | [Hz]   |
| <i>Parameter 16-71 Relay Output [bin]</i>  |        |
| <i>Parameter 16-72 Counter A</i>   |        |
| <i>Parameter 16-73 Counter B</i>   |        |
| <i>Parameter 16-74 Prec. Stop Counter</i>  |        |
| <i>Parameter 16-80 Fieldbus CTW 1</i>  | hex    |
| <i>Parameter 16-82 Fieldbus REF 1</i>  | hex    |
| <i>Parameter 16-84 Comm. Option STW</i>  | hex    |
| <i>Parameter 16-85 FC Port CTW 1</i>   | hex    |
| <i>Parameter 16-86 FC Port REF 1</i>   | hex    |
| <i>Parameter 16-87 Bus Readout Alarm/Warning (This is an array parameter with the selections 16-87.0–16.87.2).</i> |        |
| <i>Parameter 16-88 Fieldbus Torque FF.</i>   |        |
| <i>Parameter 16-89 Configurable Alarm/Warning Word</i>   |        |
| <i>Parameter 16-90 Alarm Word</i>  | hex    |
| <i>Parameter 16-92 Warning Word</i>  | hex    |
| <i>Parameter 16-93 Warning Word 2</i>  | hex    |
| <i>Parameter 16-94 Ext. Status Word</i>  | hex    |
| <i>Parameter 16-95 Ext. Status Word 2</i>  | hex    |

| Operating variable               | Unit |
|----------------------------------|------|
| Parameter 16-96 Maintenance Word | hex  |
| Parameter 16-97 Alarm Word 3     | hex  |
| Parameter 16-98 Warning Word 3   | hex  |

### 4.1.3.1 Status View I

This readout state is standard after start-up or initialization. Press [Info] to obtain information about the units linked to the shown operating variables (1.1, 1.2, 1.3, 2 and 3). See the operating variables shown in the following illustration.

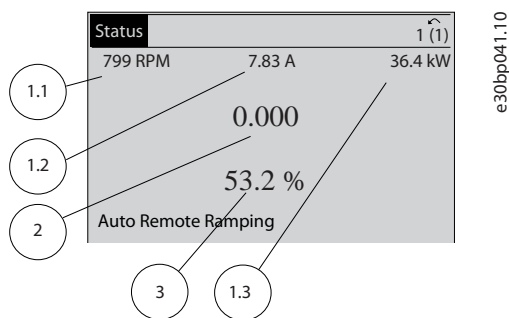

Illustration 10: Status View I

### 4.1.3.2 Status View II

See the operating variables (1.1, 1.2, 1.3, and 2) shown in the following illustration. In the example, speed, motor current, motor power, and frequency are selected as variables in the 1<sup>st</sup> and 2<sup>nd</sup> lines.

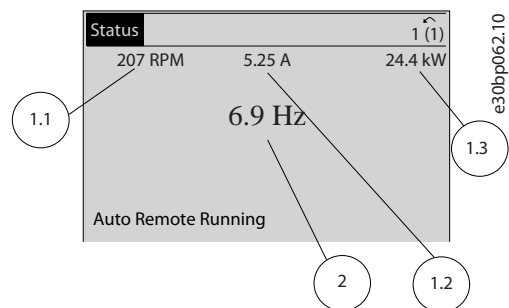

Illustration 11: Status View II

### 4.1.3.3 Status View III

This state shows the event and action of the smart logic control.

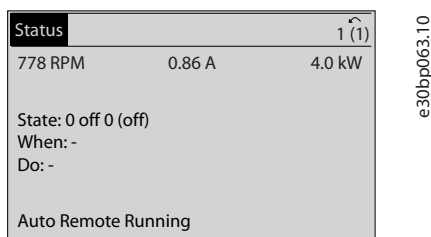

Illustration 12: Status View III

## 4.1.4 Parameter Setup

The drive can be used for practically all assignments. The drive offers 2 programming modes:

- Main menu mode
- Quick menu mode



Main menu provides access to all parameters.

Quick menu takes the user through a few parameters, making it possible to start operating the drive. Change a parameter in either main menu mode or quick menu mode.

### 4.1.5 Quick Menu Key Functions

Press [Quick Menu] to enter a list of different areas contained in the *Quick Menu*.

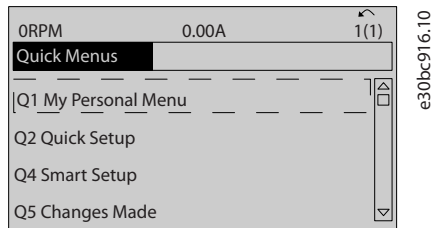

**Illustration 13: Quick Menu**

Select *Q1 My Personal Menu* to show the selected personal parameters. These parameters are selected in *parameter 0-25 My Personal Menu*. Up to 50 different parameters can be added in this menu.

Select *Q2 Quick Setup* to go through a selection of parameters to get the motor running almost optimally. The default settings for the other parameters consider the required control functions and the configuration of signal inputs/outputs (control terminals). The parameter selection is effected with the navigation keys. The parameters in the following table are accessible.

**Table 2: Selection of Parameter**

| Parameter  | Setting   |
|--|---|
| <i>Parameter 0-01 Language</i>                         | Select the language. Default is [0] <i>English</i> .                            |
| <i>Parameter 1-20 Motor Power [kW]</i>                 | [kW]  |
| <i>Parameter 1-22 Motor Voltage</i>                    | [V]   |
| <i>Parameter 1-23 Motor Frequency</i>                  | [Hz]  |
| <i>Parameter 1-24 Motor Current</i>                    | [A]   |
| <i>Parameter 1-25 Motor Nominal Speed</i>              | [RPM]   |
| <i>Parameter 5-12 Terminal 27 Digital Input</i>        | [0] <i>No function</i> <sup>(1)</sup>   |
| <i>Parameter 1-29 Automatic Motor Adaptation (AMA)</i> | [1] <i>Enable complete AMA</i>  |
| <i>Parameter 3-02 Minimum Reference</i>                | [RPM]   |
| <i>Parameter 3-03 Maximum Reference</i>                | [RPM]   |
| <i>Parameter 3-41 Ramp 1 Ramp Up Time</i>              | [s]   |
| <i>Parameter 3-42 Ramp 1 Ramp Down Time</i>            | [s]   |
| <i>Parameter 3-13 Reference Site</i>                   | Select whether to control the drive via digital inputs, LCP, or remote control. |

<sup>1</sup> If terminal 27 is set to [0] *No operation*, no connection to +24 V on terminal 27 is necessary.

Select *Changes made* to get information about:

- The last 10 changes. Use the [▲] [▼] navigation keys to scroll between the last 10 changed parameters.
- The changes made since default setting.

Select *Loggings* to get information about the shown line readouts. The information is shown as graphs. Only parameters selected in *parameter 0-20 Display Line 1.1 Small* and *parameter 0-24 Display Line 3 Large* can be viewed. It is possible to store up to 120 samples in the memory for later reference.

### 4.1.6 Initial Commissioning

The easiest way of carrying out the initial commissioning is by pressing [Quick Menu] and following the quick setup procedure using LCP 102 (read the following table from left to right). The example applies to open-loop applications.

Table 3: Quick Setup Procedure

| Press   |  |  |  |  |
|---|--|--|--|--|
|   |  | Q2 Quick Menu.   |  |  |
| <i>Parameter 0-01 Language</i>                  |  | Set language.  |  |  |
| <i>Parameter 1-20 Motor Power [kW]</i>          |  | Set motor nameplate power.   |  |  |
| <i>Parameter 1-22 Motor Voltage</i>             |  | Set nameplate voltage.   |  |  |
| <i>Parameter 1-23 Motor Frequency</i>           |  | Set nameplate frequency.   |  |  |
| <i>Parameter 1-24 Motor Current</i>             |  | Set nameplate current.   |  |  |
| <i>Parameter 1-25 Motor Nominal Speed</i>       |  | Set nameplate speed in RPM.  |  |  |
| <i>Parameter 5-12 Terminal 27 Digital Input</i> |  | If terminal default is [2] Coast inverse, it is possible to change this setting to [0] No function. No connection to terminal 27 is then needed for running AMA. |  |  |

|  |  |  |  |  |
|--|--|--|--|--|
| <p>Parameter 1-29 Automatic Motor Adaptation (AMA)</p> |  | <p>Set desired AMA function. Enable complete AMA is recommended.</p>                       |  |  |
| <p>Parameter 3-02 Minimum Reference</p>                |  | <p>Set the minimum speed of the motor shaft.</p>   |  |  |
| <p>Parameter 3-03 Maximum Reference</p>                |  | <p>Set the maximum speed of the motor shaft.</p>   |  |  |
| <p>Parameter 3-41 Ramp 1 Ramp Up Time</p>              |  | <p>Set the ramp-up time with reference to synchronous motor speed, <math>n_s</math>.</p>   |  |  |
| <p>Parameter 3-42 Ramp 1 Ramp Down Time</p>            |  | <p>Set the ramp-down time with reference to synchronous motor speed, <math>n_s</math>.</p> |  |  |
| <p>Parameter 3-13 Reference Site</p>                   |  | <p>Set the site from where the reference must work.</p>                                    |  |  |

Another easy way of commissioning the drive is by using the smart application setup (SAS), which can also be found by pressing [Quick Menu]. To set up the applications listed, follow the instructions on the successive screens.

The [Info] key can be used throughout the SAS to see help information for various selections, settings, and messages. The following 3 applications are included:

- Mechanical brake.
- Conveyor.
- Pump/fan.

The following 4 fieldbusses can be selected:

- PROFIBUS.
- PROFINET.
- DeviceNet.
- EtherNet/IP.

## NOTICE

The drive ignores the start conditions when SAS is active.

## NOTICE

The smart setup runs automatically on the first power-up of the drive or after a reset to factory settings. If no action is taken, the SAS screen automatically disappears after 10 minutes.

### 4.1.7 Main Menu Mode

Press [Main Menu] to enter the main menu mode. The readout in the following illustration appears on the display. The middle and bottom sections in the display show a list of parameter groups, which can be selected by toggling the [▲] and [▼] keys.

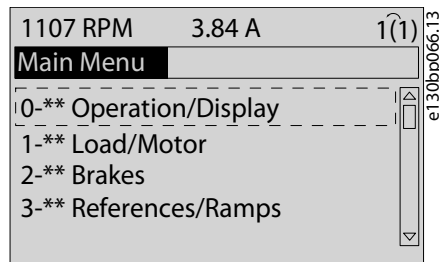

Illustration 14: Main Menu Mode

Each parameter has a name and number which remain the same regardless of the programming mode. In the main menu mode, the parameters are divided into groups. The first digit of the parameter number (from the left) indicates the parameter group number.

All parameters can be changed in the Main Menu. However, depending on the choice of configuration (*parameter 1-00 Configuration Mode*), some parameters can be hidden. For example, open loop hides all the PID parameters, and other enabled options make more parameter groups visible.

### 4.1.8 Parameter Selection

In the main menu mode, the parameters are divided into groups. Select a parameter group with the navigation keys.

After selecting a parameter group, select a parameter with the navigation keys.

The middle section on the display shows the parameter number and name, and the selected parameter value.

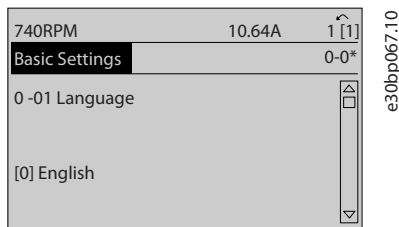

Illustration 15: Parameter Selection

### 4.1.9 Changing Data

The procedure for changing data in the quick menu mode and the main menu mode is the same. Press [OK] to change the selected parameter.

The procedure for changing data depends on whether the selected parameter represents a numeric data value or a text value.

### 4.1.10 Changing a Text Value

If the selected parameter is a text value, change the text value with the [▲] [▼] keys.

Place the cursor on the value to save and press [OK].

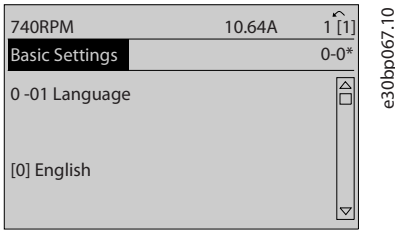

Illustration 16: Changing a Text Value

### 4.1.11 Changing a Data Value

If the selected parameter shows a numeric data value, change the selected data value with the [◀] [▶] and the [▲] [▼] navigation keys. Press the [◀] [▶] keys to move the cursor horizontally.

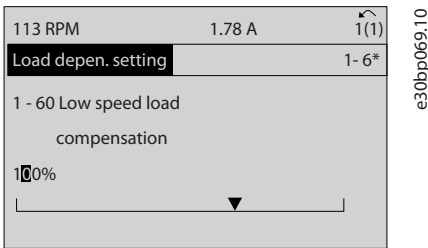

Illustration 17: Changing a Data Value

Press the [▲] [▼] keys to change the data value. [▲] increases the data value, and [▼] decreases the data value. Place the cursor on the value to save and press [OK].

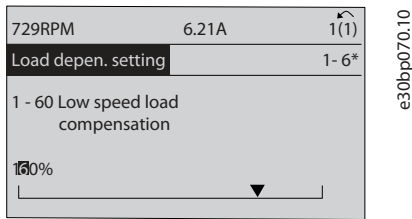

Illustration 18: Saving a Data Value

### 4.1.12 Infinitely Variable Change of Numeric Data Value

If the selected parameter shows a numeric data value, select a digit with [◀] [▶].

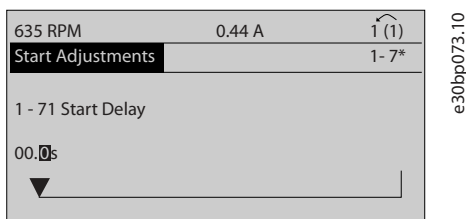

Illustration 19: Selecting a Digit

Change the selected digit infinitely variably with [▲] [▼]. The cursor indicates the selected digit. Place the cursor on the digit to save and press [OK].

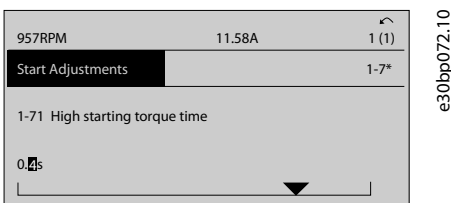

Illustration 20: Saving

### 4.1.13 Value, Step by Step

Certain parameters can be changed step by step. This applies to:

- Parameter 1-20 Motor Power [kW].
- Parameter 1-22 Motor Voltage.
- Parameter 1-23 Motor Frequency.

The parameters are changed both as a group of numeric data values and as numeric data values that are infinitely varying.

### 4.1.14 Readout and Programming of Indexed Parameters

Parameters are indexed when placed in a rolling stack. Parameter 15-30 Fault Log: Error Code to parameter 15-32 Alarm Log: Time contain a fault log, which can be read out. Select a parameter, press [OK], and press the [▲] [▼] keys to scroll through the value log.

#### 4.1.14.1 Changing Values of Indexed Parameters

Change parameter 3-10 Preset Reference as an example.

##### Procedure

1. Select the parameter, press [OK], and press [▲] [▼] to scroll through the indexed values.
2. To change the parameter value, select the indexed value and press [OK].
3. Change the value by pressing [▲] [▼].
4. Press [OK] to accept the new setting.
5. Press [Cancel] to abort. Press [Back] to leave the parameter.

## 4.2 Numerical Local Control Panel

The following instructions are valid for the numerical LCP (LCP 101).

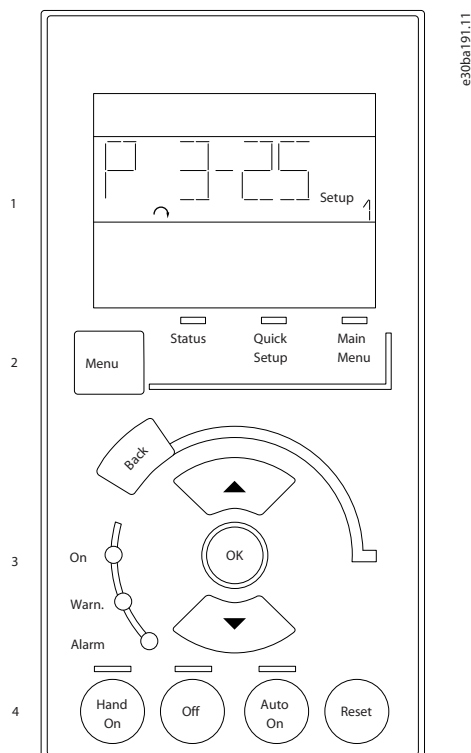

Illustration 21: NLCP

The NLCP is divided into 4 functional groups:

Table 4: Functional Groups of NLCP

|   |   |
|---|---|
| 1 | Numerical display.  |
| 2 | Menu keys and indicator lights - changing parameters and switching between display functions. |
| 3 | Navigation keys and indicator lights.   |
| 4 | Operation keys and indicator lights.  |

**Display line**

Status messages showing icons and numeric value.

**Indicator lights**

- Green LED/On: indicates if control section is on.
- Yellow LED/Wrn: indicates a warning.
- Flashing red LED/Alarm: indicates an alarm.

**4.2.1 LCP Keys**

The control keys are divided into functions. The keys below the display and indicator lights are used for parameter setup, including option of display indication during normal operation.

Table 5: LCP Keys and Description

| LCP keys                     | Description   |
|------------------------------|---|
| [Status]                     | <p>Indicates the status of the drive and/or the motor.<br/>If an alarm occurs, the NLCP automatically switches to status mode. Several alarms can be shown.</p> <div style="text-align: center; background-color: #cccccc; padding: 5px; margin: 10px 0;"><b>NOTICE</b></div> <p style="text-align: center;">Parameter copy is not possible with LCP 101 numerical local control panel.</p> <div style="text-align: center; margin: 10px 0;"> </div> <p><b>Illustration 22: Status Mode</b></p> <div style="text-align: center; margin: 10px 0;"> </div> <p><b>Illustration 23: Alarm</b></p> |
| [Quick Menu]/<br>[Main Menu] | <p>Used for programming the parameters in the Quick Menu and Main Menu, respectively. When the value flashes, press [▲] or [▼] to change parameter values. Parameters with functional options show values such as [1], [2], and so on. For a description of the different options, see the individual parameter descriptions in <a href="#">5 Parameter Descriptions</a>.</p>   |

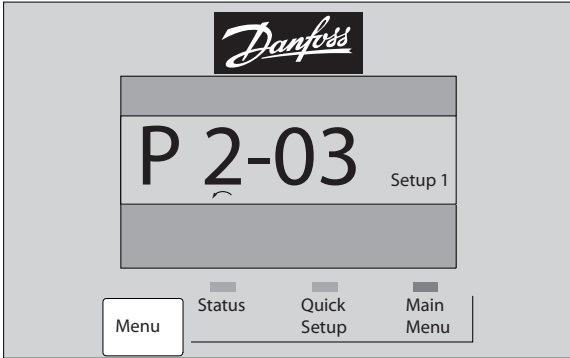
| LCP keys        | Description  |
|-----------------|--|
|                 |  <p style="text-align: right; font-size: small;">e30bp079,10</p> <p><b>Illustration 24: Main Menu/Quick Setup</b></p>   |
| [Back]          | Returns to the previous step or layer in the navigation structure.   |
| Navigation keys | <p>The 2 navigation keys are used to navigate between the different options available in Quick Menu and Main Menu. Press the keys to move the cursor.</p> <p><b>[OK]</b> Press to select a parameter marked by the cursor and to enable the change of a parameter.</p> |

**Local control keys:** Local control keys are at the bottom of the control panel.

**Table 6: Local Control Keys and Description**

| LCP keys  | Description   |
|-----------|---|
| [Hand On] | <p>Enables control of the drive via the LCP.</p> <p>[Hand On] also starts the motor, and it is now possible to enter the motor speed data with the navigation keys. The key can be selected as [1] Enable or [0] Disable via parameter 0-40 [Hand on] Key on LCP.</p> <p>External stop signals activated with control signals or a fieldbus override a start command via the LCP.</p> <p>The following control signals are still active when [Hand On] is activated:</p> <ul style="list-style-type: none"> <li>• [Hand On] - [Off] - [Auto On]</li> <li>• Reset</li> <li>• Coast stop inverse</li> <li>• Reversing</li> <li>• Setup select lsb - Setup select msb</li> <li>• Stop command from serial communication</li> <li>• Quick stop</li> <li>• DC brake</li> </ul> |
| [Off]     | <p>Stops the connected motor. The key can be selected as [1] Enable or [0] Disable via parameter 0-41 [Off] Key on LCP.</p> <p>If the external stop function is not selected and the [Off] key is inactive, the motor can be stopped by disconnecting the voltage.</p>  |
| [Auto On] | <p>Enables the drive to be controlled via the control terminals and/or serial communication.</p> <p>When a start signal is applied on the control terminals and/or the bus, the drive starts. The key can be selected as [1] Enable or [0] Disable via parameter 0-42 [Auto on] Key on LCP.</p>   |



| LCP keys | Description   |
|----------|---|
|          | <b>NOTICE</b>   |
|          | An active HAND-OFF-AUTO signal via the digital inputs has higher priority than the control keys [Hand On] – [Auto On].                        |
| [Reset]  | Is used for resetting the drive after an alarm (trip). It can be selected as [1] Enable or [0] Disable via parameter 0-43 [Reset] key on LCP. |

### 4.3 Restoring Factory Default Settings Using the Recommended Initialization

#### NOTICE

##### LOSS OF DATA

Restoring default settings results in a loss of programming, motor data, localization, and monitoring records.

- To create a back-up, upload data to the LCP before initialization.

1. Press [Main Menu] twice to access parameters.
2. Go to *parameter 14-22 Operation Mode* and press [OK].

*Parameter 14-22 Operation Mode* does not reset the following settings:

- Running hours.
- Serial communication options.
- Personal menu settings.
- Fault log, alarm log, and other monitoring functions.

3. Scroll to *Initialization* and press [OK].
4. Remove power to the unit and wait for the display to turn off.
5. Apply power to the unit. Default parameter settings are restored during start-up. Start-up takes slightly longer than normal.
6. After *alarm 80, Drive initialized* appears, press [Reset].

### 4.4 Restoring Factory Default Settings Using Manual Initialization

#### NOTICE

##### LOSS OF DATA

Restoring default settings results in a loss of programming, motor data, localization, and monitoring records.

- To create a back-up, upload data to the LCP before initialization.

#### Procedure

1. Remove power to the unit and wait for the display to turn off.
2. Press and hold [Status], [Main Menu], and [OK] simultaneously while applying power to the unit (approximately 5 s or until an audible click sounds and the fan starts).

Manually initializing does not reset the following parameter settings:

- *Parameter 15-00 Operating Hours*
- *Parameter 15-03 Power Up's*
- *Parameter 15-04 Over Temp's*
- *Parameter 15-05 Over Volt's*

Start-up takes slightly longer than normal.

**N O T I C E**

A manual initialization also resets serial communication, RFI filter settings, and fault log settings.

## 5 Parameter Descriptions

### 5.1 Parameter Group 0-\*\* Operation and Display

Parameters related to the fundamental functions of the drive, function of the LCP keys, and configuration of the LCP display.

#### 5.1.1 0-0\* Basic Settings

##### Parameter 0-01 Language

Table 7: Parameter 0-01 Language

| 0-01 Language              |                        |                               |
|----------------------------|------------------------|-------------------------------|
| Default value: [0] English | Parameter type: Option | Setup: 1 setup                |
| Conversion index: –        | Data type: Uint8       | Change during operation: True |

Defines the language to be used in the display. All languages are available in the drive. English cannot be erased or manipulated.

| Option | Name         | Description |
|--------|--------------|-------------|
| [0]*   | English      |             |
| [1]    | Deutsch      |             |
| [2]    | Français     |             |
| [3]    | Dansk        |             |
| [4]    | Español      |             |
| [5]    | Italiano     |             |
| [6]    | Svenska      |             |
| [7]    | Nederlands   |             |
| [10]   | Chinese      |             |
| [20]   | Suomi        |             |
| [22]   | English US   |             |
| [27]   | Greek        |             |
| [28]   | Bras. Port   |             |
| [36]   | Slovenian    |             |
| [39]   | Korean       |             |
| [40]   | Japanese     |             |
| [41]   | Turkish      |             |
| [42]   | Trad.Chinese |             |
| [43]   | Bulgarian    |             |
| [44]   | Srpski       |             |
| [45]   | Romanian     |             |
| [46]   | Magyar       |             |
| [47]   | Czech        |             |

| Option | Name             | Description |
|--------|------------------|-------------|
| [48]   | Polski           |             |
| [49]   | Russian          |             |
| [50]   | Thai             |             |
| [51]   | Bahasa Indonesia |             |

Parameter 0-02 Motor Speed Unit

Table 8: Parameter 0-02 Motor Speed Unit

| 0-02 Motor Speed Unit  |                        |                                |
|------------------------|------------------------|--------------------------------|
| Default value: [0] RPM | Parameter type: Option | Setup: 2 setups                |
| Conversion index: –    | Data type: Uint8       | Change during operation: False |

**NOTICE**

This parameter cannot be adjusted while the motor is running.

**NOTICE**

Changing the motor speed unit resets certain parameters to their initial value. Select the motor speed unit before modifying other parameters.

The information shown in the display depends on the settings in *parameter 0-02 Motor Speed Unit* and *parameter 0-03 Regional Settings*. The default settings of *parameter 0-02 Motor Speed Unit* and *parameter 0-03 Regional Settings* depend on the region to which the drive is supplied.

| Option | Name | Description  |
|--------|------|--|
| [0]    | RPM  | Select to show motor speed variables and parameters using motor speed (RPM).     |
| [1]    | Hz   | Select to show motor speed variables and parameters using output frequency (Hz). |

Parameter 0-03 Regional Settings

Table 9: Parameter 0-03 Regional Settings

| 0-03 Regional Settings           |                        |                                |
|----------------------------------|------------------------|--------------------------------|
| Default value: [0] International | Parameter type: Option | Setup: 2 setups                |
| Conversion index: –              | Data type: Uint8       | Change during operation: False |

**NOTICE**

This parameter cannot be adjusted while the motor is running.

| Option | Name          | Description  |
|--------|---------------|--|
| [0]    | International | Activate <i>parameter 1-20 Motor Power [kW]</i> for setting the motor power in kW and set the default value of <i>parameter 1-23 Motor Frequency</i> to 50 Hz. |
| [1]    | North America | Activate <i>parameter 1-20 Motor Power [kW]</i> for setting the motor power in hp and set the default value of <i>parameter 1-23 Motor Frequency</i> to 60 Hz. |

## Parameter 0-04 Operating State at Power-up (Hand)

Table 10: Parameter 0-04 Operating State at Power-up (Hand)

| 0-04 Operating State at Power-up (Hand) |                        |                               |
|---|------------------------|-------------------------------|
| Default value: [1] Forced stop, ref=old | Parameter type: Option | Setup: All setups             |
| Conversion index: –                     | Data type: Uint8       | Change during operation: True |

Select the operating mode upon reconnection of the drive to mains voltage after power-down in hand-on mode.

| Option | Name                 | Description  |
|--------|----------------------|--|
| [0]    | Resume               | Restart the drive, maintaining the start/stop settings (applied by [Hand On]/[Off]) selected before the power-down of the drive. |
| [1]*   | Forced stop, ref=old | Restart the drive with a saved local reference after mains voltage reappears and after pressing [Hand On].                       |
| [2]    | Forced stop, ref=0   | Reset the local reference to 0 when restarting the drive.  |

## 5.1.2 0-1\* Set-up Operations

Define and control the individual parameter setups. The drive has 4 parameter setups that can be programmed independently of each other. This makes the drive very flexible and able to solve advanced control functionality problems, often saving the cost of external control equipment. Parameter setups can be used to program the drive to operate according to 1 control scheme in 1 setup (for example, motor 1 for horizontal movement) and another control scheme in another setup (for example, motor 2 for vertical movement). Alternatively, parameter setups can be used by an OEM machine builder to identically program all their factory-fitted drives for different machine types within a range to have the same parameters. During production/commissioning, simply select a specific setup depending on which machine the drive is installed on.

The active setup (that is the setup in which the drive is currently operating) can be selected in *parameter 0-10 Active Set-up* and is shown in the LCP. By using multi setup, it is possible to switch between setups with the drive running, or it can be stopped via digital input or serial communication commands. If it is necessary to change setups while the drive is running, ensure that *parameter 0-12 This Set-up Linked to* is programmed as required. By using *parameter 0-11 Edit Set-up*, it is possible to edit parameters within any of the setups while continuing the operation of the drive in its active setup, which can be a different setup to the 1 being edited. By using *parameter 0-51 Set-up Copy*, it is possible to copy parameter settings between the setups to enable quicker commissioning if similar parameter settings are required in different setups.

Use *parameter 0-51 Set-up Copy* to copy a setup to 1 or all other setups. Stop the drive before switching between setups where parameters marked not changeable during operation have different values. To avoid conflicting settings of the same parameter within 2 different setups, link the setups together using *parameter 0-12 This Set-up Linked to*. Parameters which are not changeable during operation are marked FALSE in the *Change during operation* field.

## Parameter 0-10 Active Set-up

Table 11: Parameter 0-10 Active Set-up

| 0-10 Active Set-up          |                        |                               |
|-----------------------------|------------------------|-------------------------------|
| Default value: [1] Set-up 1 | Parameter type: Option | Setup: 1 setup                |
| Conversion index: –         | Data type: Uint8       | Change during operation: True |

Select the setup to control the drive functions.

| Option | Name          | Description  |
|--------|---------------|--|
| [0]    | Factory setup | Cannot be changed. It contains the Danfoss data set and can be used as a data source when returning the other setups to a known state. |
| [1]*   | Set-up 1      | [1] Set-up 1 to [4] Set-up 4 are the 4 separate parameter setups within which all parameters can be programmed.                        |
| [2]    | Set-up 2      |  |

| Option | Name         | Description  |
|--------|--------------|--|
| [3]    | Set-up 3     |  |
| [4]    | Set-up 4     |  |
| [9]    | Multi Set-up | Remote setup selections using digital inputs and the serial communication port. This setup used the settings from <i>parameter 0-12 This Set-up Linked to</i> . Stop the drive before making changes to open-loop and closed-loop functions. |

## Parameter 0-11 Edit Set-up

Table 12: Parameter 0-11 Edit Set-up

| 0-11 Edit Set-up            |                        |                               |
|-----------------------------|------------------------|-------------------------------|
| Default value: [1] Set-up 1 | Parameter type: Option | Setup: All setups             |
| Conversion index: –         | Data type: Uint8       | Change during operation: True |

Select the setup to be edited (programmed) during operation, either the active setup or 1 of the inactive setups.

| Option | Name          | Description   |
|--------|---------------|---|
| [0]    | Factory setup | Cannot be edited, but it is useful as a data source to return the other setups to a known state.  |
| [1]*   | Set-up 1      | [1] Set-up 1 to [4] Set-up 4 can be edited freely during operation, independently of the active setup.                                  |
| [2]    | Set-up 2      |   |
| [3]    | Set-up 3      |   |
| [4]    | Set-up 4      |   |
| [9]    | Active Set-up | Can also be edited during operation. Edit the selected setup from a range of sources: LCP, FC RS485, FC USB, or up to 5 fieldbus sites. |

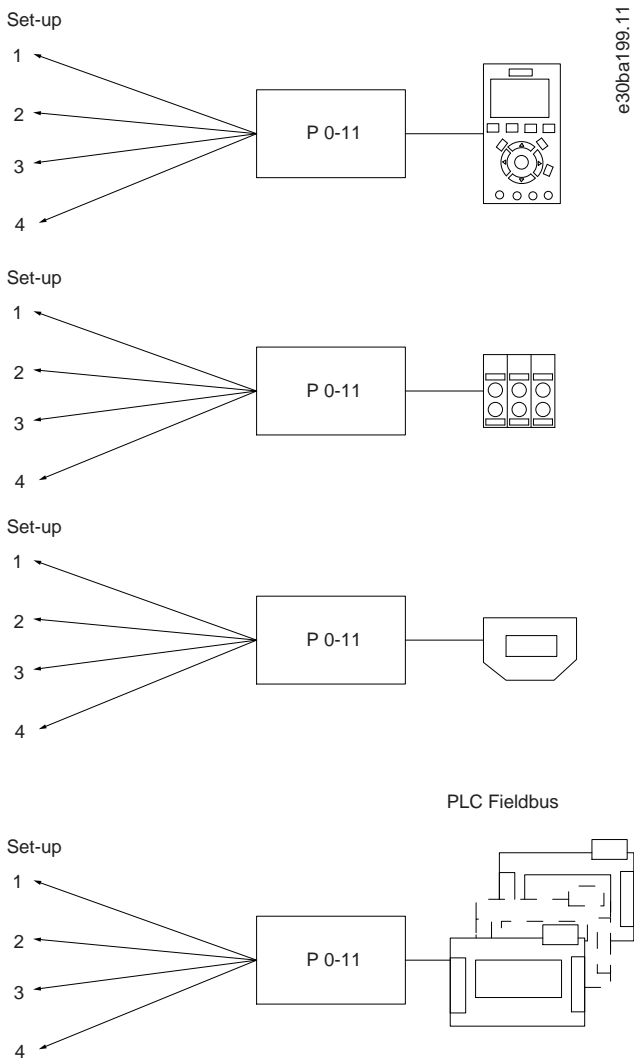

Illustration 25: Edit Setup

Parameter 0-12 This Set-up Linked to

Table 13: Parameter 0-12 This Set-up Linked to

| 0-12 This Set-up Linked to    |                        |                                |
|-------------------------------|------------------------|--------------------------------|
| Default value: [0] Not linked | Parameter type: Option | Setup: All setups              |
| Conversion index: –           | Data type: Uint8       | Change during operation: False |

To enable conflict-free changes from 1 setup to another during operation, link setups containing parameters which are not changeable during operation. The link ensures synchronizing of the not changeable during operation-parameter values when moving from 1 setup to another during operation. Not changeable during operation-parameters can be identified by the label FALSE in the *Change during operation* field. *Parameter 0-12 This Set-up Linked to* is used by [9] *Multi set-up in parameter 0-10 Active Set-up*. Multi setup is used to move from 1 setup to another during operation.

| Option | Name       | Description |
|--------|------------|-------------|
| [0]*   | Not linked |             |
| [1]    | Set-up 1   |             |

| Option | Name     | Description |
|--------|----------|-------------|
| [2]    | Set-up 2 |             |
| [3]    | Set-up 3 |             |
| [4]    | Set-up 4 |             |

**Example**

Use multi set-up to shift from setup 1 to setup 2 while the motor is running. Program in setup 1 first, then ensure that setup 1 and setup 2 are synchronized (or linked). Synchronization can be performed in 2 ways:

- Select the following options:
  - [2] Set-up 2 in parameter 0-11 Edit Set-up
  - Set parameter 0-12 This Set-up Linked to to [1] Set-up 1.

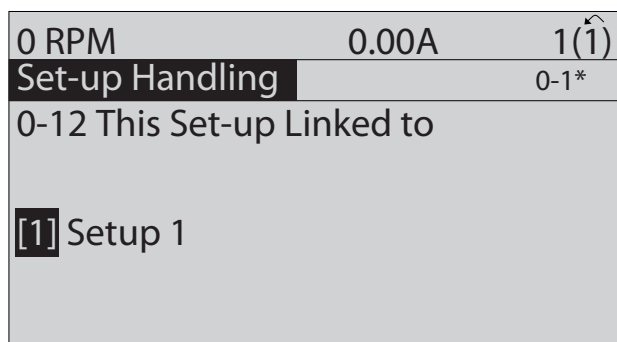

e/75bp075.12

Illustration 26: Setup 1

- While still in setup 1, copy setup 1 to setup 2. Then set parameter 0-12 This Set-up Linked to to [2] Set-up 2.

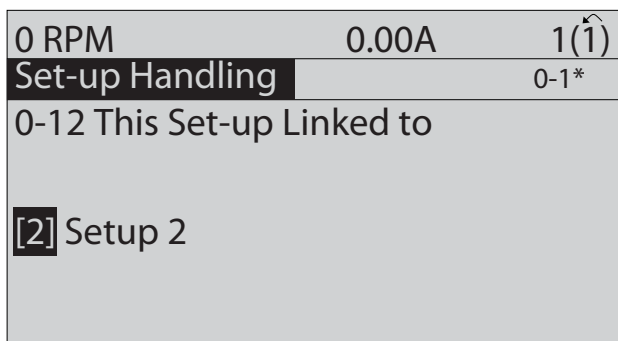

e30bp076.11

Illustration 27: Setup 2

Parameter 0-13 Readout: Linked Set-ups

Table 14: Parameter 0-13 Readout: Linked Set-ups

| 0-13 Readout: Linked Set-ups |   |                                |
|------------------------------|---|--------------------------------|
| Default value: 0             | Parameter type: Range, 0 – 255, Array [5] | Setup: All setups              |
| Conversion index: 0          | Data type: Uint16                         | Change during operation: False |

View a list of all the setups linked by parameter 0-12 This Set-up Linked to. The parameter has 1 index for each parameter setup. The value for each index shows which setups are linked to that parameter setup.



Table 15: Setup Link Example

| Index | LCP value |
|-------|-----------|
| 0     | {0}       |
| 1     | {1,2}     |
| 2     | {1,2}     |
| 3     | {3}       |
| 4     | {4}       |

## Parameter 0-14 Readout: Edit Set-ups/Channel

Table 16: Parameter 0-14 Readout: Edit Set-ups/Channel

| 0-14 Readout: Edit Set-ups/Channel |   |                                |
|------------------------------------|---|--------------------------------|
| Default value: 0                   | Parameter type: Range, -2147483648–2147483647 | Setup: All setups              |
| Conversion index: 0                | Data type: Int32                              | Change during operation: False |

View the setting of *parameter 0-11 Edit Set-up* for each of the 4 different communication channels. When the number is shown as a hex number, as it is in the LCP, each number represents 1 channel. Numbers 1–4 represent a setup number; F means factory setting; and A means active setup. The channels are, from right to left: LCP, FC bus, USB, HPFB1-5.

**Example**

The number AAAAAA21h means the following:

- The drive received the setting of setup 2 via a fieldbus channel. The selection is reflected in *parameter 0-11 Edit Set-up*.
- A user selected setup 1 via the LCP.
- All other channels are using the active setup.

## Parameter 0-15 Readout: Actual Set-up

Table 17: Parameter 0-15 Readout: Actual Set-up

| 0-15 Readout: Actual Set-up |                              |                                |
|-----------------------------|------------------------------|--------------------------------|
| Default value: 0            | Parameter type: Range, 0–255 | Setup: All setups              |
| Conversion index: 0         | Data type: Uint8             | Change during operation: False |

Makes it possible to read out the active setup, also when [9] *Multi Set-up* is selected in *parameter 0-10 Active Set-up*.

## 5.1.3 0-2\* LCP Display

Define the variables shown in the LCP.

For information on how to write display texts, refer to:

- Parameter 0-37 Display Text 1.
- Parameter 0-38 Display Text 2.
- Parameter 0-39 Display Text 3.

## Parameter 0-20 Display Line 1.1 Small

Table 18: Parameter 0-20 Display Line 1.1 Small

| 0-20 Display Line 1.1 Small     |                        |                               |
|---------------------------------|------------------------|-------------------------------|
| Default value: [1617] Speed RPM | Parameter type: Option | Setup: All setups             |
| Conversion index: –             | Data type: Uint16      | Change during operation: True |

Select a variable for display in line 1, left position.

| Option | Name                           | Description  |
|--------|--------------------------------|--|
| [0]    | None                           | No display value selected.   |
| [9]    | Performance Monitor            |  |
| [15]   | Readout: actual setup          |  |
| [37]   | Display Text 1                 | Enables an individual text string to be written for showing in the LCP or to be read via serial communication. |
| [38]   | Display Text 2                 | Enables an individual text string to be written for showing in the LCP or to be read via serial communication. |
| [39]   | Display Text 3                 | Enables an individual text string to be written for showing in the LCP or to be read via serial communication. |
| [89]   | Date and Time Readout          | Shows the current date and time.   |
| [748]  | PCD Feed Forward               |  |
| [953]  | PROFIBUS Warning Word          | Shows the PROFIBUS communication warnings.   |
| [1005] | Readout Transmit Error Counter | View the number of CAN control transmission errors since the last power-up.                                    |
| [1006] | Readout Receive Error Counter  | View the number of CAN control receipt errors since the last power-up.   |
| [1007] | Readout Bus Off Counter        | View the number of bus off-events since the last power-up.   |
| [1013] | Warning Parameter              | View a DeviceNet-specific warning word. One separate bit is assigned to every warning.                         |
| [1230] | Warning Parameter              |  |
| [1397] | Alert Alarm Word               |  |
| [1398] | Alert Warning Word             |  |
| [1399] | Alert Status Word              |  |
| [1472] | Legacy Alarm Word              |  |
| [1473] | Legacy Warning Word            |  |
| [1474] | Leg. Ext. Status Word          |  |
| [1500] | Operating Hours                |  |
| [1501] | Running Hours                  | View the number of running hours of the motor.   |
| [1502] | kWh Counter                    | View the mains power consumption in kWh.   |
| [1580] | Fan Running Hours              |  |
| [1587] | kWh Counter Hires              |  |
| [1600] | Control Word                   | View the control word sent from the drive via the serial communication port in hex code.                       |
| [1601] | Reference [Unit]               | Total reference (sum of digital/analog/preset/bus/freeze reference/catch up and slow down) in selected unit.   |
| [1602] | Reference %                    | Total reference (sum of digital/analog/preset/bus/freeze reference/catch up and slow down) in percent.         |
| [1603] | Status Word                    | Present status word.   |

| Option  | Name                          | Description   |
|---------|-------------------------------|---|
| [1605]  | Main Actual Value [%]         | View the 2-byte word sent with the status word to the bus master reporting the main actual value in %.  |
| [1606]  | Actual Position               | Actual position in position units selected in <i>parameter 17-70 Position Unit</i> .  |
| [1607]  | Target Position               | Active target position in position units selected in <i>parameter 17-70 Position Unit</i> .   |
| [1608]  | Position Error                | Actual position PI error in position units selected in <i>parameter 17-70 Position Unit</i> .   |
| [1609]  | Custom Readout                | View the user-defined readouts as defined in: <ul style="list-style-type: none"> <li>• <i>Parameter 0-30 Custom Readout Unit</i></li> <li>• <i>Parameter 0-31 Custom Readout Min Value</i></li> <li>• <i>Parameter 0-32 Custom Readout Max Value</i></li> </ul> |
| [1610]  | Power [kW]                    | Actual power consumed by the motor in kW.   |
| [1611]  | Power [hp]                    | Actual power consumed by the motor in hp.   |
| [1612]  | Motor Voltage                 | Voltage supplied to the motor.  |
| [1613]  | Frequency                     | Motor frequency, that is, the output frequency from the drive in Hz.  |
| [1614]  | Motor Current                 | Phase current of the motor measured as effective value.   |
| [1615]  | Frequency [%]                 | Motor frequency, that is, the output frequency from the drive in percent.   |
| [1616]  | Torque [Nm]                   | Actual motor torque in Nm.  |
| [1617]* | Speed [RPM]                   | Speed in RPM (revolutions per minute), that is, the motor shaft speed in closed loop.   |
| [1618]  | Motor Thermal                 | Thermal load on the motor calculated by the ETR function.   |
| [1619]  | Thermistor Sensor Temperature |   |
| [1620]  | Motor Angle                   |   |
| [1621]  | Torque [%] High Res.          |   |
| [1622]  | Torque [%]                    | Present motor load as a percentage of the rated motor torque.   |
| [1623]  | Motor Shaft Power [kW]        |   |
| [1624]  | Calibrated Stator Resistance  |   |
| [1625]  | Torque [Nm] High              |   |
| [1628]  | Angle Error                   |   |
| [1630]  | DC Link Voltage               | DC-link voltage in the drive.   |
| [1631]  | System Temp.                  |   |
| [1632]  | Brake Energy /s               | Present brake power transferred to an external brake resistor. Stated as an instant value.  |
| [1633]  | Brake Energy Average          | Brake power transferred to an external brake resistor. The mean power is calculated continuously for the most recent 120 s.   |
| [1634]  | Heatsink Temp.                | Present heat sink temperature of the drive. The cutout limit is 95 ±5 °C (203 ±9 °F); cutting back in occurs at 70 ±5 °C (158 ±9 °F).   |
| [1635]  | Inverter Thermal              | Percentage load of the inverters.   |

| Option | Name                         | Description   |
|--------|------------------------------|---|
| [1636] | Inv. Nom. Current            | Nominal current of the inverter.  |
| [1637] | Inv. Max. Current            | Maximum current of the inverter.  |
| [1638] | SL Controller State          | State of the event executed by the control.   |
| [1639] | Control Card Temp.           | Temperature of the control card.  |
| [1642] | Service Log Counter          |   |
| [1643] | Timed Actions Status         | See <i>parameter group 23-0* Timed Actions</i> .  |
| [1644] | Speed Error [RPM]            |   |
| [1645] | Motor Phase U Current        |   |
| [1646] | Motor Phase V Current        |   |
| [1647] | Motor Phase W Current        |   |
| [1648] | Speed. Ref. After Ramp [RPM] |   |
| [1650] | External Reference           | Sum of the external reference as a percentage, that is, the sum of analog/pulse/bus.  |
| [1651] | Pulse Reference              | Frequency in Hz connected to the digital inputs (18, 19 or 32, 33).   |
| [1652] | Feedback[Unit]               | Reference value from programmed digital inputs.   |
| [1653] | Digi Pot Reference           | View the contribution of the digital potentiometer to the actual refernece feedback.  |
| [1657] | Feedback [RPM]               |   |
| [1660] | Digital Input                | Signal states from the 6 digital terminals (18, 19, 27, 29, 32, and 33). There are 16 bits in total, but only 6 of them are used. Input 18 corresponds to the far left of the used bits. Signal log=0; Signal high=1. |
| [1661] | Terminal 53 Switch Setting   | Setting of input terminal 53. Current=0; Voltage=1.   |
| [1662] | Analog Input 53              | Actual value at input 53 either as a reference or protection value.   |
| [1663] | Terminal 54 Switch Setting   | Setting of input terminal 54. Current=0; Voltage=1.   |
| [1664] | Analog Input 54              | Actual value at input 54 either as reference or protection value.   |
| [1665] | Analog Output 42 [mA]        | Actual value at output 42 in mA. Use <i>parameter 6-50 Terminal 42 Output</i> to select the value to be shown.  |
| [1666] | Digital Output [bin]         | Binary value of all digital outputs.  |
| [1667] | Freq. Input #29 [Hz]         | Actual value of the frequency applied at terminal 29 as an impulse input.   |
| [1668] | Freq. Input #33 [Hz]         | Actual value of the frequency applied at terminal 33 as an impulse input.   |
| [1669] | Pulse Output #27 [Hz]        | Actual value of impulses applied to terminal 27 in digital output mode.   |
| [1670] | Pulse Output #29 [Hz]        | Actual value of impulses applied to terminal 29 in digital output mode.   |
| [1671] | Relay Output [bin]           | View the settings of all relays.  |
| [1672] | Counter A                    | Application-dependent (for example, SLC control).   |
| [1673] | Counter B                    | Application-dependent( for example, SLC control).   |
| [1674] | Prec. Stop Counter           | Shows the actual value of the counter.  |

| Option | Name                            | Description  |
|--------|---------------------------------|--|
| [1675] | Analog In X30/11                | Actual value at input X30/11 either as reference or protection value.  |
| [1676] | Analog In X30/12                | Actual value at input X30/12 either as reference or protection value.  |
| [1677] | Analog Out X30/8 [mA]           | Actual value at output X30/8 in mA. Use <i>parameter 6-60 Terminal X30/8 Output</i> to select the value to be shown.       |
| [1678] | Analog Out X45/1 [mA]           |  |
| [1679] | Analog Out X45/3 [mA]           |  |
| [1680] | Fieldbus CTW 1                  | Control word (CTW) received from the bus master.   |
| [1681] | Fieldbus Sync. REF              |  |
| [1682] | Fieldbus REF 1                  | Mains reference value sent with control word from the bus master.  |
| [1683] | Fielbus Pos. REF                |  |
| [1684] | Comm. Option STW                | Extended fieldbus communication option status word.  |
| [1685] | FC Port CTW 1                   | Control word (CTW) received from the bus master.   |
| [1686] | FC Port REF 1                   | Status word (STW) sent to the bus master.  |
| [1687] | Bus Readout Alarm/Warning       |  |
| [1688] | Fieldbus Torque FF              |  |
| [1689] | Configurable Alarm/Warning Word |  |
| [1690] | Alarm Word                      | One or more alarms in a hex code.  |
| [1691] | Alarm Word 2                    | One or more alarms in a hex code.  |
| [1692] | Warning Word                    | One or more warnings in a hex code.  |
| [1693] | Warning Word 2                  | One or more warnings in a hex code.  |
| [1694] | Ext. Status Word                | One or more status conditions in a hex code.   |
| [1695] | Ext. Status Word 2              | One or more status conditions in a hex code.   |
| [1696] | Maintenance Word                | The bits reflect the status for the programmed preventive maintenance events in <i>parameter group 23-1* Maintenance</i> . |
| [1697] | Alarm Word 3                    |  |
| [1698] | Warning Word 3                  |  |
| [1804] | Mech Brake Count                |  |
| [1820] | Commanded Position              |  |
| [1821] | Master Position                 |  |
| [1823] | Virtual Master Pos.             |  |
| [1827] | Safe Opt. Est. Speed            |  |
| [1828] | Safe Opt. Meas. Speed           |  |
| [1829] | Safe Opt. Speed Error           |  |

| Option | Name                           | Description |
|--------|--------------------------------|-------------|
| [1836] | Analog Input X48/2 [mA]        |             |
| [1837] | Temp. Input X48/4              |             |
| [1838] | Temp. Input X48/7              |             |
| [1839] | Temp. Input X48/10             |             |
| [1840] | Analog Input X49/1             |             |
| [1841] | Analog Input X49/3             |             |
| [1842] | Analog Input X49/5             |             |
| [1843] | Analog Out X49/7               |             |
| [1844] | Analog Out X49/9               |             |
| [1845] | Analog Out X49/11              |             |
| [1846] | X49 Digital Output [bin]       |             |
| [1860] | Digital Input 2                |             |
| [1870] | Mains Voltage                  |             |
| [1871] | Mains Frequency                |             |
| [1872] | Mains Imbalance                |             |
| [1873] | Worst Inrush                   |             |
| [1874] | Inrush Mode                    |             |
| [1875] | Rectifier DC Volt.             |             |
| [1876] | Mains Voltage2                 |             |
| [1877] | Mains Frequency2               |             |
| [1878] | Mains Imbalance2               |             |
| [1879] | Rectifier DC Volt.2            |             |
| [1890] | Process PID Error              |             |
| [1891] | Process PID Output             |             |
| [1892] | Process PID Clamped Output     |             |
| [1893] | Process PID Gain Scaled Output |             |
| [1899] | Speed PID Torque FF. [Nm]      |             |
| [2316] | Maintenance Text               |             |
| [3019] | Wobble Delta Freq. Scaled      |             |
| [3110] | Bypass Status Word             |             |
| [3111] | Bypass Running Hours           |             |
| [3401] | PCD 1 Write to MCO             |             |

| Option | Name                   | Description |
|--------|------------------------|-------------|
| [3402] | PCD 2 Write to MCO     |             |
| [3403] | PCD 3 Write to MCO     |             |
| [3404] | PCD 4 Write to MCO     |             |
| [3405] | PCD 5 Write to MCO     |             |
| [3406] | PCD 6 Write to MCO     |             |
| [3407] | PCD 7 Write to MCO     |             |
| [3408] | PCD 8 Write to MCO     |             |
| [3409] | PCD 9 Write to MCO     |             |
| [3410] | PCD 10 Write to MCO    |             |
| [3421] | PCD 1 Read from MCO    |             |
| [3422] | PCD 2 Read from MCO    |             |
| [3423] | PCD 3 Read from MCO    |             |
| [3424] | PCD 4 Read from MCO    |             |
| [3425] | PCD 5 Read from MCO    |             |
| [3426] | PCD 6 Read from MCO    |             |
| [3427] | PCD 7 Read from MCO    |             |
| [3428] | PCD 8 Read from MCO    |             |
| [3429] | PCD 9 Read from MCO    |             |
| [3430] | PCD 10 Read from MCO   |             |
| [3440] | Digital Inputs         |             |
| [3441] | Digital Outputs        |             |
| [3450] | Actual Position        |             |
| [3451] | Commanded Position     |             |
| [3452] | Actual Master Position |             |
| [3453] | Slave Index Position   |             |
| [3454] | Master Index Position  |             |
| [3455] | Curve Position         |             |
| [3456] | Track Error            |             |
| [3457] | Synchronizing Error    |             |
| [3458] | Actual Velocity        |             |
| [3459] | Actual Master Velocity |             |
| [3460] | Synchronizing Status   |             |

| Option | Name                         | Description |
|--------|------------------------------|-------------|
| [3461] | Axis Status                  |             |
| [3462] | Program Status               |             |
| [3464] | MCO 302 Status               |             |
| [3465] | MCO 302 Control              |             |
| [3466] | SPI Error Counter            |             |
| [3470] | MCO Alarm Word 1             |             |
| [3471] | MCO Alarm Word 2             |             |
| [4029] | B-EMF Protection Log Readout |             |
| [4235] | S-CRC Value                  |             |
| [4282] | Safe Control Word            |             |
| [4283] | Safe Status Word             |             |
| [4285] | Active Safe Func.            |             |
| [4286] | Safe Option Info             |             |
| [4521] | Status                       |             |
| [4522] | Progress                     |             |
| [4523] | Baseline Failure             |             |
| [4590] | Stator [%]                   |             |
| [4591] | Load [%]                     |             |
| [4592] | Sensor 1 [%]                 |             |
| [4593] | Sensor 1 [unit]              |             |
| [4594] | Sensor 2 [%]                 |             |
| [4595] | Sensor 2 [unit]              |             |
| [4596] | Sensor 3 [%]                 |             |
| [4597] | Sensor 3 [unit]              |             |
| [4598] | Sensor 4 [%]                 |             |
| [4599] | Sensor 4 [unit]              |             |
| [9913] | Idle Time                    |             |
| [9914] | Paramdb requests in queue    |             |
| [9917] | tCon1 time                   |             |
| [9918] | tCon2 time                   |             |
| [9919] | Time Optimize Measure        |             |
| [9920] | Fan Ctrl deltaT              |             |



| Option | Name              | Description |
|--------|-------------------|-------------|
| [9921] | Fan Ctrl Tmean    |             |
| [9922] | Fan Ctrl NTC Cmd  |             |
| [9923] | Fan Ctrl I-term   |             |
| [9924] | Rectifier Current |             |
| [9952] | PC Debug 0        |             |
| [9953] | PC Debug 1        |             |
| [9954] | PC Debug 2        |             |
| [9961] | FPC Debug 0       |             |
| [9962] | FPC Debug 1       |             |
| [9963] | FPC Debug 2       |             |
| [9964] | FPC Debug 3       |             |
| [9965] | FPC Debug 4       |             |
| [9970] | Thread Time Fast  |             |

#### Parameter 0-21 Display Line 1.2 Small

The options are the same as those listed for *parameter 0-20 Display Line 1.1 Small*.

#### Parameter 0-22 Display Line 1.3 Small

The options are the same as those listed for *parameter 0-20 Display Line 1.1 Small*.

#### Parameter 0-23 Display Line 2 Large

The options are the same as those listed for *parameter 0-20 Display Line 1.1 Small*.

#### Parameter 0-24 Display Line 3 Large

The options are the same as those listed for *parameter 0-20 Display Line 1.1 Small*.

#### Parameter 0-25 My Personal Menu

**Table 19: Parameter 0-25 My Personal Menu**

| 0-25 My Personal Menu       |   |                               |
|-----------------------------|---|-------------------------------|
| Default value: Size related | Parameter type: Range, 0 - 9999, Array [50] | Setup: 1 setup                |
| Conversion index: 0         | Data type: Uint16                           | Change during operation: True |

Define up to 50 parameters to appear in the *Q1 Personal Menu*, accessible via the [Quick Menu] key on the LCP. The parameters are shown in the *Q1 Personal Menu* in the order they are programmed into this array parameter. Delete parameters by setting the value to 0000. For example, this can be used to provide quick, simple access to just 1 or up to 50 parameters, which require changing on a regular basis (for example, for plant maintenance reasons) or by an OEM to enable simple commissioning of their equipment.

### 5.1.4 0-3\* LCP Custom Readout

It is possible to customize the display elements for various purposes:

- Custom readout. Value proportional to speed (linear, squared, or cubed depending on the unit selected in *parameter 0-30 Custom Readout Unit*).
- Display text. Text string stored in a parameter.

#### Custom readout

The calculated value to be shown is based on the settings in:

- *Parameter 0-30 Custom Readout Unit*.
- *Parameter 0-31 Custom Readout Min Value* (linear only).

- Parameter 0-32 Custom Readout Max Value.
- Parameter 4-13 Motor Speed High Limit [RPM].
- Parameter 4-14 Motor Speed High Limit [Hz].
- Actual speed.

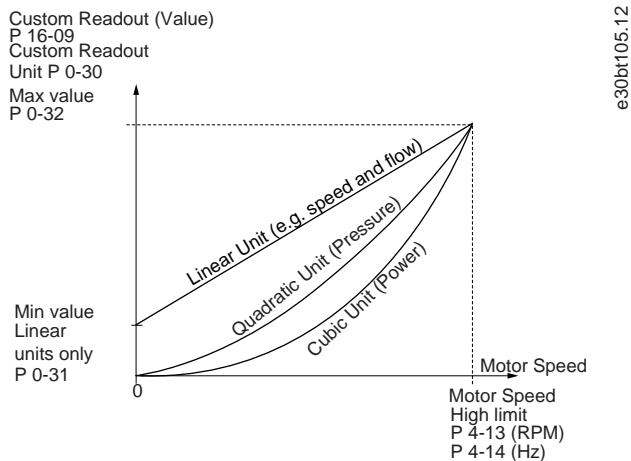

Illustration 28: Custom Readout

The relation depends on the type of unit selected in *parameter 0-30 Custom Readout Unit*.

Table 20: Speed Relations for Different Unit Types

| Unit type     | Speed relation |
|---------------|----------------|
| Dimensionless | Linear         |
| Speed         |                |
| Flow, volume  |                |
| Flow, mass    |                |
| Velocity      |                |
| Length        |                |
| Temperature   |                |
| Pressure      | Quadratic      |
| Power         | Cubic          |

Parameter 0-30 Unit for User-defined Readout

Table 21: Parameter 0-30 Unit for User-defined Readout

| 0-30 Unit for User-defined Readout |                        |                               |
|------------------------------------|------------------------|-------------------------------|
| Default value: [0] None            | Parameter type: Option | Setup: All setups             |
| Conversion index: –                | Data type: Uint8       | Change during operation: True |

It is possible to program a value to be shown in the display of the LCP. The value has a linear, squared, or cubed relation to speed. This relation depends on the unit type selected. The actual calculated value can be read in *parameter 16-09 Custom Readout*, and/or shown in the display by selecting [16-09] Custom Readout in *parameter 0-20 Display Line 1.1 Small* to *parameter 0-24 Display Line 3 Large*.

| Option | Name                | Description |
|--------|---------------------|-------------|
| [0]*   | None                |             |
| [1]    | %                   |             |
| [5]    | PPM                 |             |
| [10]   | 1/min               |             |
| [11]   | rpm                 |             |
| [12]   | Pulse/s             |             |
| [20]   | l/s                 |             |
| [21]   | l/min               |             |
| [22]   | l/h                 |             |
| [23]   | m <sup>3</sup> /s   |             |
| [24]   | m <sup>3</sup> /min |             |
| [25]   | m <sup>3</sup> /h   |             |
| [30]   | kg/s                |             |
| [31]   | kg/min              |             |
| [32]   | kg/h                |             |
| [33]   | t/min               |             |
| [34]   | t/h                 |             |
| [40]   | m/s                 |             |
| [41]   | m/min               |             |
| [45]   | m                   |             |
| [60]   | °C                  |             |
| [70]   | mbar                |             |
| [71]   | bar                 |             |
| [72]   | Pa                  |             |
| [73]   | kPa                 |             |
| [74]   | m WG                |             |
| [80]   | kW                  |             |
| [120]  | GPM                 |             |
| [121]  | gal/s               |             |
| [122]  | gal/min             |             |
| [123]  | gal/h               |             |
| [124]  | CFM                 |             |

| Option | Name                 | Description |
|--------|----------------------|-------------|
| [125]  | ft <sup>3</sup> /s   |             |
| [126]  | ft <sup>3</sup> /min |             |
| [127]  | ft <sup>3</sup> /h   |             |
| [130]  | lb/s                 |             |
| [131]  | lb/min               |             |
| [132]  | lb/h                 |             |
| [140]  | ft/s                 |             |
| [141]  | ft/min               |             |
| [145]  | ft                   |             |
| [160]  | °F                   |             |
| [170]  | psi                  |             |
| [171]  | lb/in <sup>2</sup>   |             |
| [172]  | in WG                |             |
| [173]  | ft WG                |             |
| [176]  | kpsi                 |             |
| [177]  | MPa                  |             |
| [178]  | kBar                 |             |
| [180]  | hp                   |             |

Parameter 0-31 Min Value of User-defined Readout

Table 22: Parameter 0-31 Min Value of User-defined Readout

| 0-31 Min Value of User-defined Readout |   |                               |
|--|---|-------------------------------|
| Default value: 0 CustomReadoutUnit     | Parameter type: Range, -999999.99 CustomReadoutUnit - par. 0-32 | Setup: All setups             |
| Conversion index: -2                   | Data type: Int32  | Change during operation: True |

This parameter sets the minimum value of the custom-defined readout (occurs at 0 speed). Only possible to set different from 0 when selecting a linear unit in *parameter 0-30 Unit for User-defined Readout*. For quadratic and cubic units, the minimum value is 0. Parameter 0-32 Max Value of User-defined Readout

Table 23: Parameter 0-32 Max Value of User-defined Readout

| 0-32 Max Value of User-defined Readout |  |                               |
|--|--|-------------------------------|
| Default value: 100 CustomReadoutUnit   | Parameter type: Range, par. 0-31 -999999.99 Custom-ReadoutUnit | Setup: All setups             |
| Conversion index: -2                   | Data type: Int32   | Change during operation: True |

This parameter sets the maximum value to be shown when the speed of the motor has reached the set value for *parameter 4-13 Motor Speed High Limit [RPM]* or *parameter 4-14 Motor Speed High Limit [Hz]* (depends on setting in *parameter 0-02 Motor Speed Unit*).

## Parameter 0-33 Source for User-defined Readout

Table 24: Parameter 0-33 Source of User-defined Readout

| 0-33 Source of User-defined Readout |                        |                               |
|-------------------------------------|------------------------|-------------------------------|
| Default value: [240] Default Source | Parameter type: Option | Setup: All setups             |
| Conversion index: –                 | Data type: Uint8       | Change during operation: True |

Enter the source of the user-defined readout.

| Option | Name                      | Description |
|--------|---------------------------|-------------|
| [105]  | Torque related to rated   |             |
| [143]  | PID Clamped Output 4–20mA |             |
| [240]* | Default Source            |             |

## Parameter 0-37 Display Text 1

Table 25: Parameter 0-37 Display Text 1

| 0-37 Display Text 1 |                             |                               |
|---------------------|-----------------------------|-------------------------------|
| Default value: 0    | Parameter type: Range, 0–25 | Setup: 1 setup                |
| Conversion index: 0 | Data type: VisStr[25]       | Change during operation: True |

Enter a text which can be viewed in the graphical display by selecting [37] Display Text 1 in

- *Parameter 0-20 Display Line 1 Small*
- *Parameter 0-21 Display Line 1.2 Small*
- *Parameter 0-22 Display Line 1.3 Small*
- *Parameter 0-23 Display Line 2 Large*
- *Parameter 0-24 Display Line 3 Large*

## Parameter 0-38 Display Text 2

Table 26: Parameter 0-38 Display Text 2

| 0-38 Display Text 2 |                             |                               |
|---------------------|-----------------------------|-------------------------------|
| Default value: 0    | Parameter type: Range, 0–25 | Setup: 1 setup                |
| Conversion index: 0 | Data type: VisStr[25]       | Change during operation: True |

Enter a text which can be viewed in the graphical display by selecting [38] Display Text 2 in

- *Parameter 0-20 Display Line 1 Small*
- *Parameter 0-21 Display Line 1.2 Small*
- *Parameter 0-22 Display Line 1.3 Small*
- *Parameter 0-23 Display Line 2 Large*
- *Parameter 0-24 Display Line 3 Large*

## Parameter 0-39 Display Text 3

Table 27: Parameter 0-39 Display Text 3

| 0-39 Display Text 3 |                             |                               |
|---------------------|-----------------------------|-------------------------------|
| Default value: 0    | Parameter type: Range, 0–25 | Setup: 1 setup                |
| Conversion index: 0 | Data type: VisStr[25]       | Change during operation: True |

Enter a text which can be viewed in the graphical display by selecting [39] *Display Text 3* in

- *Parameter 0-20 Display Line 1 Small*
- *Parameter 0-21 Display Line 1.2 Small*
- *Parameter 0-22 Display Line 1.3 Small*
- *Parameter 0-23 Display Line 2 Large*
- *Parameter 0-24 Display Line 3 Large*

### 5.1.5 0-4\* LCP Keypad

Enable, disable, and password protect individual keys on the LCP.

Parameter 0-40 [Hand On] Key on LCP

Table 28: Parameter 0-40 [Hand On] Key on LCP

| 0-40 [Hand On] Key on LCP  |                        |                               |
|----------------------------|------------------------|-------------------------------|
| Default value: [1] Enabled | Parameter type: Option | Setup: All setups             |
| Conversion index: –        | Data type: Uint8       | Change during operation: True |

| Option | Name                  | Description   |
|--------|-----------------------|---|
| [0]    | Disabled              | No effect when [Hand On] is pressed. Select [0] <i>Disabled</i> to avoid accidental start of the drive in hand-on mode.   |
| [1]*   | Enabled               | The LCP switches to hand-on mode directly when [Hand On] is pressed.  |
| [2]    | Password              | After pressing [Hand On] a password is required. If <i>parameter 0-40 [Hand on] Key on LCP</i> is included in <i>My Personal Menu</i> , define the password in <i>parameter 0-65 Personal Menu Password</i> . Otherwise define the password in <i>parameter 0-60 Main Menu Password</i> . |
| [3]    | Hand Off/On           | When [Hand On] is pressed once, the LCP switches to Off mode. When pressed again, the LCP switches to hand-on mode.   |
| [4]    | Hand Off/On w. Passw. | Same as option [3] <i>Hand Off/On</i> but a password is required (see option [2] <i>Password</i> ).   |
| [9]    | Enabled, ref=0        |   |

Parameter 0-41 [Off] Key on LCP

Table 29: Parameter 0-41 [Off] Key on LCP

| 0-41 [Off] Key on LCP      |                        |                               |
|----------------------------|------------------------|-------------------------------|
| Default value: [1] Enabled | Parameter type: Option | Setup: All setups             |
| Conversion index: –        | Data type: Uint8       | Change during operation: True |

| Option | Name     | Description   |
|--------|----------|---|
| [0]    | Disabled | Avoids accidental stop of the drive.  |
| [1]*   | Enabled  |   |
| [2]    | Password | Avoids unauthorized stop. If <i>parameter 0-41 [Off] Key on LCP</i> is included in the Quick Menu, then define the password in <i>parameter 0-65 Personal Menu Password</i> . |

## Parameter 0-42 [Auto On] Key on LCP

Table 30: Parameter 0-42 [Auto On] Key on LCP

| 0-42 [Auto On] Key on LCP  |                        |                               |
|----------------------------|------------------------|-------------------------------|
| Default value: [1] Enabled | Parameter type: Option | Setup: All setups             |
| Conversion index: –        | Data type: Uint8       | Change during operation: True |

| Option | Name     | Description  |
|--------|----------|--|
| [0]    | Disabled | Avoids accidental stop of the drive in auto-on mode.   |
| [1]*   | Enabled  |  |
| [2]    | Password | Avoids unauthorized start in auto-on mode. If <i>parameter 0-42 [Auto on] Key on LCP</i> is included in the Quick Menu, then define the password in <i>parameter 0-65 Personal Menu Password</i> . |

## Parameter 0-43 [Reset] Key on LCP

Table 31: Parameter 0-43 [Reset] Key on LCP

| 0-43 [Reset] Key on LCP    |                        |                               |
|----------------------------|------------------------|-------------------------------|
| Default value: [1] Enabled | Parameter type: Option | Setup: All setups             |
| Conversion index: –        | Data type: Uint8       | Change during operation: True |

| Option | Name                 | Description  |
|--------|----------------------|--|
| [0]    | Disabled             | No effect when [Reset] is pressed. Avoids accidental alarm reset.  |
| [1]    | Enabled              |  |
| [2]    | Password             | Avoids unauthorized start in auto-on mode. If <i>parameter 0-43 [Reset] Key on LCP</i> is included in the Quick Menu, then define the password in <i>parameter 0-65 Personal Menu Password</i> . |
| [7]    | Enabled without OFF  | Resets the drive without setting it in Off mode.   |
| [8]    | Password without OFF | Resets the drive without setting it in Off mode. A password is required when pressing [Reset] (see option [2] <i>Password</i> ).   |

## Parameter 0-44 [Off/Reset] Key on LCP

Table 32: Parameter 0-44 [Off/Reset] Key on LCP

| 0-44 [Off/Reset] Key on LCP |                        |                               |
|-----------------------------|------------------------|-------------------------------|
| Default value: [1] Enabled  | Parameter type: Option | Setup: All setups             |
| Conversion index: –         | Data type: Uint8       | Change during operation: True |

Enable or disable the [Off/Reset] key.

| Option | Name     | Description |
|--------|----------|-------------|
| [0]    | Disabled |             |
| [1]*   | Enabled  |             |
| [2]    | Password |             |

Parameter 0-45 [Drive Bypass] Key on LCP

Table 33: Parameter 0-45 [Drive Bypass] Key on LCP

| 0-45 [Drive Bypass] Key on LCP |                        |                               |
|--------------------------------|------------------------|-------------------------------|
| Default value: [1] Enabled     | Parameter type: Option | Setup: All setups             |
| Conversion index: –            | Data type: Uint8       | Change during operation: True |

Press [Off] and select [0] Disabled to avoid unintended stop of the drive. Press [Off] and select [2] Password to avoid unauthorized bypass of the drive. If parameter 0-45 [Drive Bypass] Key on LCP is included in the Quick Menu, define the password in parameter 0-65 Personal Menu Password.

| Option | Name     | Description       |
|--------|----------|-------------------|
| [0]    | Disabled | Disables the key. |
| [1]*   | Enabled  |                   |
| [2]    | Password |                   |

5.1.6 0-5\* Copy/Save

Copy parameters from and to the LCP. Use these parameters for saving and copying setups from 1 drive to another.

Parameter 0-50 LCP Copy

Table 34: Parameter 0-50 LCP Copy

| 0-50 LCP Copy              |                        |                                |
|----------------------------|------------------------|--------------------------------|
| Default value: [0] No copy | Parameter type: Option | Setup: All setups              |
| Conversion index: –        | Data type: Uint8       | Change during operation: False |

**NOTICE**

This parameter cannot be adjusted while the motor is running.

| Option | Name                 | Description   |
|--------|----------------------|---|
| [0]*   | No copy              |   |
| [1]    | All to LCP           | Copies all parameters in all setups from the drive memory to the LCP memory.  |
| [2]    | All from LCP         | Copies all parameters in all setups from the LCP memory to the drive memory.  |
| [3]    | Size indep. from LCP | Copy only the parameters that are independent of the motor size. This selection can be used to program several drives with the same function without disturbing motor data. |
| [4]    | File from MCO to LCP |   |
| [5]    | File from LCP to MCO |   |
| [6]    | Data from DYN to LCP |   |
| [7]    | Data from LCP to DYN |   |
| [9]    | Safety Par. from LCP |   |
| [10]   | Delete LCP copy data | Use to delete the copy after the transfer is complete.  |



## Parameter 0-51 Set-up Copy

Table 35: Parameter 0-51 Set-up Copy

| 0-51 Set-up Copy           |                        |                                |
|----------------------------|------------------------|--------------------------------|
| Default value: [0] No copy | Parameter type: Option | Setup: All setups              |
| Conversion index: –        | Data type: Uint8       | Change during operation: False |

| Option | Name             | Description   |
|--------|------------------|---|
| [0]*   | No copy          | No function.  |
| [1]    | Copy to set-up 1 | Copies all parameters in the present programming setup (defined in <i>parameter 0-11 Edit Set-up</i> ) to set-up 1. |
| [2]    | Copy to set-up 2 | Copies all parameters in the present programming setup (defined in <i>parameter 0-11 Edit Set-up</i> ) to set-up 2. |
| [3]    | Copy to set-up 3 | Copies all parameters in the present programming setup (defined in <i>parameter 0-11 Edit Set-up</i> ) to set-up 3. |
| [4]    | Copy to set-up 4 | Copies all parameters in the present programming setup (defined in <i>parameter 0-11 Edit Set-up</i> ) to set-up 4. |
| [9]    | Copy to all      | Copies the parameters in the present setup to each of the setups 1 to 4.  |

## 5.1.7 0-6\* Password

## Parameter 0-60 Main Menu Password

Table 36: Parameter 0-60 Main Menu Password

| 0-60 Main Menu Password |                                     |                               |
|-------------------------|-------------------------------------|-------------------------------|
| Default value: 100      | Parameter type: Range, -9999 - 9999 | Setup: 1 setup                |
| Conversion index: 0     | Data type: Int16                    | Change during operation: True |

Define the password for access to the Main Menu via the [Main Menu] key. If *parameter 0-61 Access to Main Menu w/o Password* is set to [0] Full access, this parameter is ignored.

## Parameter 0-61 Access to Main Menu w/o Password

Table 37: Parameter 0-61 Access to Main Menu w/o Password

| 0-61 Access to Main Menu w/o Password |                        |                               |
|---------------------------------------|------------------------|-------------------------------|
| Default value: [0] Full access        | Parameter type: Option | Setup: 1 setup                |
| Conversion index: –                   | Data type: Uint8       | Change during operation: True |

| Option | Name           | Description   |
|--------|----------------|---|
| [0]*   | Full access    | Disables password defined in <i>parameter 0-60 Main Menu Password</i> . |
| [1]    | LCP: Read only | Prevent unauthorized editing of Main Menu parameters.                   |
| [2]    | LCP: No access | Prevent unauthorized viewing and editing of Main Menu parameters.       |
| [3]    | Bus: Read only | Read-only functions for parameters on fieldbus and/or FC standard bus.  |

| Option | Name           | Description   |
|--------|----------------|---|
| [4]    | Bus: No access | No access to parameters is allowed via fieldbus and/or FC standard bus. |
| [5]    | All: Read only | Read-only function for parameters on LCP, fieldbus, or FC standard bus. |
| [6]    | All: No access | No access from LCP, fieldbus, or FC standard bus is allowed.            |

If [0] Full access is selected, parameter 0-60 Main Menu Password, parameter 0-65 Personal Menu Password, and parameter 0-66 Access to Personal Menu w/o Password are ignored.

### N O T I C E

A more complex password protection is available for OEMs upon request.

#### Parameter 0-65 Personal Menu Password

Table 38: Parameter 0-65 Personal Menu Password

| 0-65 Personal Menu Password |                                     |                               |
|-----------------------------|-------------------------------------|-------------------------------|
| Default value: 200          | Parameter type: Range, -9999 - 9999 | Setup: 1 setup                |
| Conversion index: 0         | Data type: Int16                    | Change during operation: True |

Define the password for access to the Quick Menu via the [Quick Menu] key. If parameter 0-66 Access to Personal Menu w/o Password is set to [0] Full access, this parameter is ignored.

#### Parameter 0-66 Access to Personal Menu w/o Password

Table 39: Parameter 0-66 Access to Personal Menu w/o Password

| 0-66 Access to Personal Menu w/o Password |                        |                               |
|---|------------------------|-------------------------------|
| Default value: [0] Full access            | Parameter type: Option | Setup: 1 setup                |
| Conversion index: –                       | Data type: Uint8       | Change during operation: True |

If parameter 0-61 Access to Main Menu w/o Password is set to [0] Full access, then this parameter is ignored.

| Option | Name           | Description  |
|--------|----------------|--|
| [0]*   | Full access    | Disables password defined in parameter 0-65 Personal Menu Password.                |
| [1]    | LCP: Read only | Prevent unauthorized editing of Quick Menu parameters.                             |
| [3]    | Bus: Read only | Read-only functions for Quick Menu parameters on fieldbus and/or FC standard bus.  |
| [5]    | All: Read only | Read-only function for Quick Menu parameters on LCP, fieldbus, or FC standard bus. |

#### Parameter 0-67 Bus Password Access

Table 40: Parameter 0-67 Bus Password Access

| 0-67 Bus Password Access |                                 |                               |
|--------------------------|---------------------------------|-------------------------------|
| Default value: 0         | Parameter type: Range, 0 - 9999 | Setup: All setups             |
| Conversion index: 0      | Data type: Uint16               | Change during operation: True |

Use this parameter to unlock the drive via fieldbus or VLT® Motion Control Tool MCT 10.

## Parameter 0-68 Safety Parameter Password

Table 41: Parameter 0-68 Safety Parameters Password

| 0-68 Safety Parameters Password |                                 |                               |
|---------------------------------|---------------------------------|-------------------------------|
| Default value: 300              | Parameter type: Range, 0 - 9999 | Setup: 1 setup                |
| Conversion index: 0             | Data type: Uint16               | Change during operation: True |

Enter the password for the safety parameters access. If *parameter 0-69 Password Protection of Safety Parameters* is set to [0] Disabled, this parameter is ignored.

## Parameter 0-69 Password Protection of Safety Parameters

Table 42: Parameter 0-69 Password Protection of Safety Parameters

| 0-69 Password Protection of Safety Parameters |                        |                               |
|---|------------------------|-------------------------------|
| Default value: [0] Disabled                   | Parameter type: Option | Setup: 1 setup                |
| Conversion index: –                           | Data type: Uint8       | Change during operation: True |

| Option | Name     | Description |
|--------|----------|-------------|
| [0]*   | Disabled |             |
| [1]    | Enabled  |             |

## 5.1.8 0-7\* Clock Settings

## Parameter 0-70 Date and Time

Table 43: Parameter 0-70 Date and Time

| 0-70 Date and Time          |                              |                               |
|-----------------------------|------------------------------|-------------------------------|
| Default value: Size related | Parameter type: Range, 0 - 0 | Setup: All setups             |
| Conversion index: 0         | Data type: TimeOfDay         | Change during operation: True |

Sets the date and time of the internal clock. The format to be used is set in *parameter 0-71 Date Format* and *parameter 0-72 Time Format*. When using the VLT® Real-time Clock MCB 117 option, the time is synchronized at 15:00 every day.

## Parameter 0-71 Date Format

Table 44: Parameter 0-71 Date Format

| 0-71 Date Format              |                        |                               |
|-------------------------------|------------------------|-------------------------------|
| Default value: [1] DD-MM-YYYY | Parameter type: Option | Setup: 1 setup                |
| Conversion index: –           | Data type: Uint8       | Change during operation: True |

| Option | Name       | Description |
|--------|------------|-------------|
| [0]    | YYYY-MM-DD |             |
| [1]*   | DD-MM-YY   |             |
| [2]    | MM/DD/YYYY |             |

## Parameter 0-72 Time Format

Table 45: Parameter 0-72 Time Format

| 0-72 Time Format        |                        |                               |
|-------------------------|------------------------|-------------------------------|
| Default value: [0] 24 h | Parameter type: Option | Setup: 1 setup                |
| Conversion index: –     | Data type: Uint8       | Change during operation: True |

| Option | Name | Description |
|--------|------|-------------|
| [0]*   | 24 h |             |
| [1]    | 12 h |             |

## Parameter 0-73 Time Zone Offset

Table 46: Parameter 0-73 Time Zone Offset

| 0-73 Time Zone Offset |                                       |                                |
|-----------------------|---------------------------------------|--------------------------------|
| Default value: 0 min  | Parameter type: Range, -780 - 780 min | Setup: 2 setups                |
| Conversion index: 70  | Data type: Int16                      | Change during operation: False |

Enter the time zone offset relative to UTC. This parameter is required for the automatic daylight saving time adjustment.

## Parameter 0-74 DST/Summertime

Table 47: Parameter 0-74 DST/Summertime

| 0-74 DST/Summertime    |                        |                               |
|------------------------|------------------------|-------------------------------|
| Default value: [0] Off | Parameter type: Option | Setup: 1 setup                |
| Conversion index: –    | Data type: Uint8       | Change during operation: True |

Select how to handle daylight saving time/summer time. For manual setting of DST/summer time, enter the start date and end date in *parameter 0-76 DST/Summertime Start* and *parameter 0-77 DST/Summertime End*.

| Option | Name   | Description |
|--------|--------|-------------|
| [0]*   | Off    |             |
| [2]    | Manual |             |

## Parameter 0-76 DST/Summertime Start

Table 48: Parameter 0-76 DST/Summertime Start

| 0-76 DST/Summertime Start   |                              |                               |
|-----------------------------|------------------------------|-------------------------------|
| Default value: Size related | Parameter type: Range, 0 - 0 | Setup: 1 setup                |
| Conversion index: 0         | Data type: TimeOfDay         | Change during operation: True |

Sets the date and time when DST/ summer time starts. The date is programmed in the format selected in *parameter 0-71 Date Format*.

## Parameter 0-77 DST/Summertime End

Table 49: Parameter 0-77 DST/Summertime End

| 0-77 DST/Summertime End     |                              |                               |
|-----------------------------|------------------------------|-------------------------------|
| Default value: Size related | Parameter type: Range, 0 - 0 | Setup: 1 setup                |
| Conversion index: 0         | Data type: TimeOfDay         | Change during operation: True |

Sets the date and time when DST/summer time ends. The date is programmed in the format selected in *parameter 0-71 Date Format*.  
Parameter 0-79 Clock Fault

Table 50: Parameter 0-79 Clock Fault

| 0-79 Clock Fault            |                        |                               |
|-----------------------------|------------------------|-------------------------------|
| Default value: [0] Disabled | Parameter type: Option | Setup: 1 setup                |
| Conversion index: –         | Data type: UInt8       | Change during operation: True |

Enables or disables the clock warning when the clock has not been set, or has been reset due to a power-down and no back-up is installed. If VLT® Analog I/O Option MCB 109 is installed, [1] *Enabled* is default.

| Option | Name     | Description |
|--------|----------|-------------|
| [0]*   | Disabled |             |
| [1]    | Enabled  |             |

## Parameter 0-81 Working Days

Table 51: Parameter 0-81 Working Days

| 0-81 Working Days                                      |                                   |                               |
|--|-----------------------------------|-------------------------------|
| Default value: Depending on the selected array element | Parameter type: Option, Array [7] | Setup: 1 setup                |
| Conversion index: –                                    | Data type: UInt8                  | Change during operation: True |

Array with 7 elements [0]–[6] shown below the parameter number in the display. Press [OK] and step between elements with [▲] and [▼]. Set for each weekday if it is a working day or a non-working day. The first element of the array is Monday. The working days are used for timed actions.

| Option | Name | Description |
|--------|------|-------------|
| [0]    | No   |             |
| [1]    | Yes  |             |

## Parameter 0-82 Additional Working Days

Table 52: Parameter 0-82 Additional Working Days

| 0-82 Additional Working Days |   |                               |
|------------------------------|---|-------------------------------|
| Default value: Size related  | Parameter type: Range, 0 - 0, Array [5] | Setup: 1 setup                |
| Conversion index: 0          | Data type: TimeOfDay                    | Change during operation: True |

Array with 5 elements [0]–[4] shown below the parameter number in the display. Press [OK] and step between elements with [▲] and [▼]. Defines dates for additional working days that would normally be non-working days according to *parameter 0-81 Working Days*.

## Parameter 0-83 Additional Non-working Days

Table 53: Parameter 0-83 Additional Non-working Days

| 0-83 Additional Non-working Days |  |                               |
|----------------------------------|--|-------------------------------|
| Default value: Size related      | Parameter type: Range, 0 - 0, Array [15] | Setup: 1 setup                |
| Conversion index: 0              | Data type: TimeOfDay                     | Change during operation: True |

Array with 15 elements [0]–[14] shown below the parameter number in the display. Press [OK] and step between elements with [▲] and [▼]. Defines dates for additional working days that would normally be non-working days according to *parameter 0-81 Working Days*.

## Parameter 0-84 Time for Fieldbus

Table 54: Parameter 0-84 Time for Fieldbus

| 0-84 Time for Fieldbus |  |                               |
|------------------------|--|-------------------------------|
| Default value: 0       | Parameter type: Range, 0 - 4294967295, Array [2] | Setup: All setups             |
| Conversion index: 0    | Data type: Uint32                                | Change during operation: True |

Shows the time for fieldbus.

## Parameter 0-85 Summer Time Start for Fieldbus

Table 55: Parameter 0-85 Summer Time Start for Fieldbus

| 0-85 Summer Time Start for Fieldbus |  |                               |
|-------------------------------------|--|-------------------------------|
| Default value: 0                    | Parameter type: Range, 0 - 4294967295, Array [2] | Setup: All setups             |
| Conversion index: 0                 | Data type: Uint32                                | Change during operation: True |

Shows the summer time start for fieldbus.

## Parameter 0-86 Summer Time End for Fieldbus

Table 56: Parameter 0-86 Summer Time End for Fieldbus

| 0-86 Summer Time End for Fieldbus |  |                               |
|-----------------------------------|--|-------------------------------|
| Default value: 0                  | Parameter type: Range, 0 - 4294967295, Array [2] | Setup: All setups             |
| Conversion index: 0               | Data type: Uint32                                | Change during operation: True |

Shows the summer time end for fieldbus.

## Parameter 0-89 Date and Time Readout

Table 57: Parameter 0-89 Date and Time Readout

| 0-89 Date and Time Readout |                               |                               |
|----------------------------|-------------------------------|-------------------------------|
| Default value: 0           | Parameter type: Range, 0 - 25 | Setup: All setups             |
| Conversion index: 0        | Data type: VisStr 25          | Change during operation: True |

Shows the current date and time. The date and time is updated continuously. The clock does not begin counting until a setting different from default has been made in *parameter 0-70 Date and Time*.

## 5.2 Parameter Group 1-\*\* Load and Motor

### 5.2.1 1-0\* General Settings

Define whether the drive operates in speed mode or torque mode, and whether the internal PID control should be active or not.

**NOTICE**

The following parameters are only available in FC 302:

- Parameter 1-02 Flux Motor Feedback Source
- Parameter 1-07 Motor Angle Offset Adjust

Parameter 1-00 Configuration Mode

Table 58: Parameter 1-00 Configuration Mode

| 1-00 Configuration Mode     |                        |                               |
|-----------------------------|------------------------|-------------------------------|
| Default value: Size related | Parameter type: Option | Setup: All setups             |
| Conversion index: -         | Data type: Uint8       | Change during operation: True |

Select the application control principle to be used when a remote reference (that is via analog input or fieldbus) is active. A remote reference can only be active when *parameter 3-13 Reference Site* is set to [0] *Linked to Hand/Auto* or [1] *Remote*.

| Op-tion | Name                  | Description   |
|---------|-----------------------|---|
| [0]     | Speed open loop       | Enables speed control (without feedback signal from motor) with automatic slip compensation for almost constant speed at varying loads. Compensations are active, but can be disabled in <i>parameter group 1-** Load and Motor</i> . Set the speed control parameters in <i>parameter group 7-0* Speed PID Ctrl.</i> |
| [1]     | Speed closed loop     | Enables speed closed-loop control with feedback. Obtain full holding torque at 0 RPM. For increased speed accuracy, provide a feedback signal and set the speed PID control. Set the speed control parameters in <i>parameter group 7-0* Speed PID Ctrl.</i>  |
| [2]     | Torque                | <div style="text-align: center;"><b>NOTICE</b></div> <p>This option is only available in FC 302.</p> <p>Enables torque closed-loop control with feedback. Only possible when <i>parameter 1-01 Motor Control Principle</i> is set to [3] <i>Flux w/motor feedb.</i></p>   |
| [3]     | Process               | Enables the use of process control in the drive. Set the process control parameters in <i>parameter groups 7-2* Process Ctrl. Feedb.</i> and <i>7-3* Process PID Ctrl.</i>  |
| [4]     | Torque open loop      | Enables the use of torque open-loop mode ( <i>parameter 1-01 Motor Control Principle</i> ). Set the torque PID parameters in <i>parameter group 7-1* Torque PI Control.</i>   |
| [5]     | Wobble                | Enables the wobble functionality in <i>parameter 30-00 Wobble Mode</i> to <i>parameter 30-19 Wobble Delta Freq. Scaled.</i>   |
| [6]     | Surface winder        | Enables the surface winder control-specific parameters in <i>parameter groups 7-2* Process Ctrl. Feedb.</i> and <i>7-3* Process PID Ctrl.</i>   |
| [7]     | Extended PID speed OL | Specific parameters in <i>parameter groups 7-2* Process Ctrl. Feedb.</i> to <i>7-5* Ext. Process PID Ctrl.</i>  |
| [8]     | Extended PID speed CL | Specific parameters in <i>parameter groups 7-2* Process Ctrl. Feedb.</i> to <i>7-5* Ext. Process PID Ctrl.</i>  |
| [9]     | Positioning           | <div style="text-align: center;"><b>NOTICE</b></div> <p>This option is only available with software version 48.XX.</p> <p>Activates positioning mode.</p>   |

| Option | Name                    | Description  |
|--------|-------------------------|--|
| [10]   | Synchronization         | <div style="text-align: center; background-color: #cccccc; padding: 5px;"><b>NOTICE</b></div> <p>This option is only available with software version 48.XX.</p> <p>Activates synchronization mode.</p>   |
| [11]   | Cyclic sync. position   | Activates cyclic synchronous position mode.  |
| [12]   | Cyclic sync. velocity   | Activates cyclic synchronous velocity mode.  |
| [15]   | Mode of operation DS402 | DS 402 operation modes are selected by <i>parameter 1-09 Mode of Operation</i> . With this selection, <i>parameter 8-10 Control Word Profile</i> is automatically set to [7] <i>CANopen DSP 402</i> and the control word bits are used according to the DS 402 profile based on the selection in <i>parameter 1-09 Mode of Operation</i> . |

Parameter 1-01 Motor Control Principle

Table 59: Parameter 1-01 Motor Control Principle

| 1-01 Motor Control Principle |                        |                                |
|------------------------------|------------------------|--------------------------------|
| Default value: Size related  | Parameter type: Option | Setup: All setups              |
| Conversion index: –          | Data type: Uint8       | Change during operation: False |

Select which motor control principle to employ.

| Option | Name            | Description  |
|--------|-----------------|--|
| [0]    | U/f             | Special motor mode, for parallel-connected motors in special motor applications. When U/f is selected, the characteristic of the control principle can be edited in <i>parameter 1-55 U/f Characteristic - U</i> and <i>parameter 1-56 U/f Characteristic - F</i> .    |
| [1]    | VVC+            | Voltage vector control principle is suitable for most applications. The main benefit of VVC+ operation is that it uses a robust motor model.   |
| [2]    | Flux sensorless | <div style="text-align: center; background-color: #cccccc; padding: 5px;"><b>NOTICE</b></div> <p>This option is only available in FC 302.</p> <p>Flux vector control without encoder feedback, for simple installation and robustness against sudden load changes.</p> |
| [3]    | Flux w/ motor   | <div style="text-align: center; background-color: #cccccc; padding: 5px;"><b>NOTICE</b></div> <p>This option is only available in FC 302.</p> <p>High accuracy speed and torque control, suitable for the most demanding applications.</p>                             |

The best shaft performance is normally achieved using either of the 2 flux vector control modes [2] *Flux sensorless* and [3] *Flux with encoder feedback*.



## Parameter 1-02 Flux Motor Feedback Source

Table 60: Parameter 1-02 Flux Motor Feedback Source

| 1-02 Flux Motor Feedback Source |                        |                                |
|---------------------------------|------------------------|--------------------------------|
| Default value: 24V encoder      | Parameter type: Option | Setup: All setups              |
| Conversion index: –             | Data type: Uint8       | Change during operation: False |

### NOTICE

This parameter cannot be adjusted while the motor is running.

### NOTICE

The options 12 and 13 are only available for software version 48.XX.

Select the source of the feedback for flux closed-loop motor control. Set *parameter 1-01 Motor Control Principle* to [3] *Flux with motor feedback option*. The feedback device is typically mounted directly on the motor shaft. The feedback device can also be mounted in the application, provided that the gear ratio between motor and encoder is fixed and accurate. Configure the gear ratio between motor and encoder in *parameter 7-94 Position PI Feedback Scale Numerator* and *parameter 7-95 Position PI Feedback Scale Denominator* without any rounding error.

| Option | Name               | Description  |
|--------|--------------------|--|
| [1]*   | 24V encoder 32/33  | Single signal generated from 24 V High Threshold Logic (HTL) encoder connected to terminals 32 and 33. Configure the 24 V encoder interface in <i>parameter group 5.7* 24 V Encoder Input</i> . Program terminals 32/33 to [0] <i>No operation</i> . |
| [2]    | MCB 102            | This option is only available for VLT® Encoder Option MCB 102. Configure the encoder interface in <i>parameter groups 17-0*, 17-1*, and 17-2*</i> .  |
| [3]    | MCB 103            | This option is only available for VLT® Resolver Option MCB 103. Configure the resolver interface in <i>parameter group 17-5*</i> .   |
| [4]    | MCO Encoder 1 X56  | The MCO encoder 1 X56 is only available with motion control options MCO 305, MCO 350 and MCO 351. Configure the encoder interface in <i>parameter group 32-3* Encoder 1</i> .  |
| [5]    | MCO Encoder 2 X55  | The MCO encoder 1 X56 is only available with motion control options MCO 305, MCO 350 and MCO 351. Configure the encoder interface in <i>parameter group 32-0* Encoder 2</i> .  |
| [6]    | Analog input 53    |  |
| [7]    | Analog input 54    |  |
| [8]    | Frequency input 29 |  |
| [9]    | Frequency input 33 |  |
| [11]   | MCB 15X            |  |
| [12]   | MCB 102 Absolute   | The option is only available for VLT® Encoder Option MCB 102 with version 4.00 and higher and when <i>parameter 17-00 Encoders Connected</i> is set to [1] <i>Two Encoders</i> .   |
| [13]   | 24V encoder 27/29  | Single-signal HTL encoder connected to digital inputs 27 and 29. 24 V encoder is configured in <i>parameter group 5.7* 24V Encoder Input</i> . Program terminals 27/29 to [0] <i>No operation</i> .  |

Parameter 1-03 Torque Characteristics

Table 61: Parameter 1-03 Torque Characteristics

| 1-03 Torque Characteristics        |                        |                               |
|------------------------------------|------------------------|-------------------------------|
| Default value: [0] Constant torque | Parameter type: Option | Setup: All setups             |
| Conversion index: –                | Data type: Uint8       | Change during operation: True |

**NOTICE**

This parameter cannot be adjusted while the motor is running.

Select the torque characteristic required. VT and AEO are both energy-saving operations.

| Op-tion | Name               | Description  |
|---------|--------------------|--|
| [0]*    | Constant torque    | Motor shaft output provides constant torque under variable speed control.  |
| [1]     | Variable torque    | Motor shaft output provides variable torque under variable speed control. Set the variable torque level in <i>parameter 14-40 VT Level</i> .   |
| [2]     | Auto energy optim. | Automatically optimizes energy consumption by minimizing magnetization and frequency via <i>parameter 14-41 AEO Minimum Magnetisation</i> and <i>parameter 14-42 Minimum AEO Frequency</i> .   |
| [5]     | Constant power     | <p>The function provides a constant power in the field weakening area. The torque shape of motor mode is used as a limit in the generator mode. This is done to limit the power in generator mode that otherwise becomes considerably larger than in motor mode, due to the high DC-link voltage available in generator mode.</p> $P_{\text{shaft}}[W] = \omega_{\text{mech}}[\text{rad/s}] \times T[\text{Nm}]$ <p><b>Illustration 29: Relationship with Constant Power</b></p> |

Parameter 1-04 Overload Mode

Table 62: Parameter 1-04 Overload Mode

| 1-04 Overload Mode          |                        |                                |
|-----------------------------|------------------------|--------------------------------|
| Default value: Size related | Parameter type: Option | Setup: All setups              |
| Conversion index: –         | Data type: Uint8       | Change during operation: False |

**NOTICE**

This parameter cannot be adjusted while the motor is running.

Use this parameter to configure the drive for either high or normal overload. When selecting the drive size, always review the technical data in the Operating Guide or the Design Guide to know the available output current.

| Option | Name          | Description  |
|--------|---------------|--|
| [0]    | High torque   | Allows up to 160% overtorque.                      |
| [1]    | Normal torque | For oversized motor. Allows up to 110% overtorque. |

#### Parameter 1-05 Local Mode Configuration

Table 63: Parameter 1-05 Local Mode Configuration

| 1-05 Local Mode Configuration        |                        |                               |
|--------------------------------------|------------------------|-------------------------------|
| Default value: [2] As mode par. 1-00 | Parameter type: Option | Setup: All setups             |
| Conversion index: –                  | Data type: Uint8       | Change during operation: True |

Select which application configuration mode (*parameter 1-00 Configuration Mode*), that is application control principle, to use when a local (LCP) reference is active. A local reference can be active only when *parameter 3-13 Reference Site* is set to [0] *Linked to Hand/Auto* or [2] *Local*. By default the local reference is active in hand-on mode only.

| Option | Name              | Description                   |
|--------|-------------------|-------------------------------|
| [0]    | Speed open loop   | Allows up to 160% overtorque. |
| [1]    | Speed closed loop |                               |
| [2]*   | As mode par. 1-00 |                               |
| [4]    | Positioning       |                               |

#### Parameter 1-06 Clockwise Direction

Table 64: Parameter 1-06 Clockwise Direction

| 1-06 Clockwise Direction  |                        |                                |
|---------------------------|------------------------|--------------------------------|
| Default value: [0] Normal | Parameter type: Option | Setup: All setups              |
| Conversion index: –       | Data type: Uint8       | Change during operation: False |

## NOTICE

This parameter cannot be adjusted while the motor is running.

This parameter defines the term clockwise corresponding to the LCP direction arrow. Used for easy change of direction of shaft rotation without swapping motor wires.

| Option | Name        | Description   |
|--------|-------------|---|
| [0]*   | Normal      | The motor shaft turns in clockwise direction when the drive is connected U⇒U, V⇒V, and W⇒W to the motor.        |
| [1]    | Inverse     | The motor shaft turns in counterclockwise direction when the drive is connected U⇒U, V⇒V, and W⇒W to the motor. |
| [2]    | Inverse all |   |

## Parameter 1-07 Motor Angle Offset Adjust

Table 65: Parameter 1-07 Motor Angle Offset Adjust

| 1-07 Motor Angle Offset Adjust |                        |                                |
|--------------------------------|------------------------|--------------------------------|
| Default value: [0] Manual      | Parameter type: Option | Setup: All setups              |
| Conversion index: –            | Data type: Uint8       | Change during operation: False |

### N O T I C E

This parameter is only valid in combination with a PM motor with feedback.

| Op-tion | Name                   | Description   |
|---------|------------------------|---|
| [0]*    | Manual                 | The functionality of this option depends on the type of the feedback device. This option sets the drive to use the motor angle offset entered in <i>parameter 1-41 Motor Angle Offset</i> , if an absolute feedback device is used. If an incremental feedback device is selected, the drive automatically adjusts the motor angle offset on the 1 <sup>st</sup> start after power-up, or when the motor data is changed. |
| [1]     | Auto                   | The drive adjusts the motor angle offset automatically on the 1 <sup>st</sup> start after power-up, or when the motor data is changed no matter what feedback device is selected. This means that the options [1] Manual and [2] Auto are identical for the incremental encoder.  |
| [2]     | Auto every start       | The drive adjusts the motor angle offset automatically on every start, or when the motor data is changed.   |
| [3]     | Off                    | Selecting this option turns the automatic offset adjustment off.  |
| [4]     | Once with store        | This option updates <i>parameter 1-41 Motor Angle Offset</i> automatically when the angle value is 0. This option is valid only for absolute feedback devices. The function uses rotor detection and then applies DC hold to make the offset adjustment more accurate.  |
| [5]     | Auto Every Start & Run | Rotor angle offset is adjusted at every start and when reducing speed below <i>parameter 1-53 Model Shift Frequency</i> . Motor control is sensorless above <i>parameter 1-53 Model Shift Frequency</i> using the estimated rotor position as feedback. Below <i>parameter 1-53 Model Shift Frequency</i> the encoder is used as feedback.  |

## Parameter 1-09 Mode of Operation

Table 66: Parameter 1-09 Mode of Operation

| 1-09 Mode of Operation            |                        |                               |
|-----------------------------------|------------------------|-------------------------------|
| Default value: [0] No mode change | Parameter type: Option | Setup: All setups             |
| Conversion index: –               | Data type: Uint8       | Change during operation: True |

### N O T I C E

This parameter is only available with software version 48.8X and newer.

Select mode of operation according to CANopen DS402. This parameter is only active when *parameter 1-00 Configuration Mode* is set to [15] Mode of operation.

| Option | Name                  | Description  |
|--------|-----------------------|--|
| [0]*   | No mode change        | No mode of operation selected. Active mode of operation is velocity mode.  |
| [1]    | Profile position mode | Basic positioning mode where the drive profile generator calculates the speed profile based on set target position, speed and ramps. |

| Option | Name                      | Description   |
|--------|---------------------------|---|
| [2]    | Velocity mode (vl)        | Basic speed mode using the set speed and ramps.   |
| [6]    | Homing mode               | Activates the homing function selected in <i>parameter 17-80 Homing Function</i> .  |
| [8]    | Cyclic sync position mode | The drive controls the position based on cyclic position reference from an external controller. Speed/ramp profile must be calculated/handled by the external controller. |
| [9]    | Cyclic sync velocity mode | The drive controls the speed based on cyclic speed reference from an external controller. Acceleration/deceleration must be handled by the external controller.           |
| [249]  | Gear mode                 | The drive is synchronizing to the provided master positions using the set gear ratio.   |
| [250]  | Cam mode                  | The drive is synchronizing to the provided master positions according to the set Cam table.   |

## 5.2.2 Motor Setups

### 5.2.2.1 Asynchronous Motor Setup

Enter the following motor data. Find the information on the motor nameplate.

- *Parameter 1-20 Motor Power [kW] or parameter 1-21 Motor Power [HP].*
- *Parameter 1-22 Motor Voltage.*
- *Parameter 1-23 Motor Frequency.*
- *Parameter 1-24 Motor Current.*
- *Parameter 1-25 Motor Nominal Speed.*

When running in flux control principle, or for optimum performance in VVC+ mode, extra motor data is required to set up the following parameters. Find the data in the motor datasheet (this data is typically not available on the motor nameplate). Run a complete automatic motor adaptation (AMA) using *parameter 1-29 Automatic Motor Adaptation (AMA) [1] Enable Complete AMA* or enter the parameters manually. *Parameter 1-36 Iron Loss Resistance (Rfe)* is always entered manually.

- *Parameter 1-30 Stator Resistance (Rs).*
- *Parameter 1-31 Rotor Resistance (Rr).*
- *Parameter 1-33 Stator Leakage Reactance (X1).*
- *Parameter 1-34 Rotor Leakage Reactance (X2).*
- *Parameter 1-35 Main Reactance (Xh).*
- *Parameter 1-36 Iron Loss Resistance (Rfe).*

#### Application-specific adjustment when running VVC+

VVC+ is the most robust control mode. In most situations, it provides optimum performance without further adjustments. Run a complete AMA for best performance.

#### Application-specific adjustment when running flux

Flux control principle is the preferred control principle for optimum shaft performance in dynamic applications. Perform an AMA since this control mode requires precise motor data. Depending on the application, further adjustments may be required.

**Table 67: Recommendations for Flux Applications**

| Application               | Settings   |
|---------------------------|--|
| Low-inertia applications  | Keep calculated values.  |
| High-inertia applications | <i>Parameter 1-66 Min. Current at Low Speed.</i> Increase current to a value between default and maximum depending on the application. Set ramp times matching the application. Too fast ramp up causes an overcurrent or overtorque. Too fast ramp down causes an overvoltage trip. |

| Application                            | Settings   |
|--|--|
| High load at low speed                 | <i>Parameter 1-66 Min. Current at Low Speed.</i> Increase current to a value between default and maximum depending on the application  |
| No-load application                    | Adjust <i>parameter 1-18 Min. Current at No Load</i> to achieve smoother motor operation by reducing torque ripple and vibration.  |
| Flux sensorless control principle only | Adjust <i>parameter 1-53 Model Shift Frequency</i> . Example 1: If the motor oscillates at 5 Hz, and dynamics performance is required at 15 Hz, set <i>parameter 1-53 Model Shift Frequency</i> to 10 Hz. Example 2: If the application involves dynamic load changes at low speed, reduce <i>parameter 1-53 Model Shift Frequency</i> . Observe the motor behavior to make sure that the model shift frequency is not reduced too much. Symptoms of inappropriate model shift frequency are motor oscillations or drive tripping. |

### 5.2.2.2 PM Motor Setup

#### NOTICE

PM motor setup is only available in FC 302.

This section describes how to set up a PM motor. Danfoss offers 2 types of PM motors: [1] Non-salient PM and [3] Salient PM. The following example covers a non-salient PM motor.

#### Initial programming steps

- To activate PM motor operation, select [1] *PM, non-salient SPM* in *parameter 1-10 Motor Construction*.

#### Programming motor data

After selecting a PM motor, the PM motor-related parameters in *parameter groups 1-2\* Motor Data, 1-3\* Adv. Motor Data, and 1-4\* Adv. Motor Data II* are active. The necessary data is on the motor nameplate and on the motor datasheet.

Program the following parameters in the order listed:

- Parameter 1-24 Motor Current.*
- Parameter 1-25 Motor Nominal Speed.*
- Parameter 1-26 Motor Cont. Rated Torque.*
- Parameter 1-39 Motor Poles.*

Run a complete AMA using *parameter 1-29 Automatic Motor Adaptation (AMA) [1] Enable Complete AMA*.

If a complete AMA is not performed, configure the following parameters manually:

- Parameter 1-30 Stator Resistance (Rs)* Enter the line-to-common stator winding resistance (Rs). If only line-line data is available, divide the line-line value by 2 to get the line-common value.
- Parameter 1-37 d-axis Inductance (Ld)* Enter the line-to-common direct axis inductance of the PM motor. If only line-line data is available, divide the line-line value by 2 to get the line-common value.
- Parameter 1-40 Back EMF at 1000 RPM.* Enter the line-to-line back EMF of the PM Motor at 1000 RPM (RMS value). Back EMF is the voltage generated by a PM motor when no drive is connected and the shaft is turned externally. It is normally specified for nominal motor speed or for 1000 RPM measured between 2 lines. If the value is not available for a motor speed of 1000 RPM, calculate the correct value as follows: If back EMF is, for example, 320 V at 1800 RPM, it can be calculated at 1000 RPM as follows:  $\text{Back EMF} = (\text{Voltage/RPM}) \times 1000 = (320/1800) \times 1000 = 178$ .

#### Test motor operation

- Start the motor at low speed (100–200 RPM). If the motor does not turn, check the installation, general programming, and motor data.
- Check if the start function in *parameter 1-70 Start Mode* fits the application requirements.

#### 5.2.2.2.1 PM Rotor Detection

This function is the recommended selection for applications where the motor starts from standstill, for example pumps or conveyors. On some motors, a sound is heard when the drive performs the rotor detection. This does not harm the motor.

To activate the rotor detection function, select [0] *Rotor detection* in *parameter 1-70 Start Mode*.

### 5.2.2.2.2 PM Parking

This function is the recommended selection for applications where the motor is rotating at slow speed, for example windmilling in fan applications. *Parameter 2-06 Parking Current* and *parameter 2-07 Parking Time* can be adjusted. Increase the factory setting of these parameters for applications with high inertia.

To activate parking, select [1] *Parking* in *parameter 1-70 Start Mode*.

### 5.2.2.2.3 Application-specific Adjustment when Running VVC+ with PM Motors

VVC+ is the most robust control mode. In most situations, it provides optimum performance without further adjustments. Run a complete AMA for best performance.

Start the motor at nominal speed. If the application does not run well, check the VVC+ PM settings. See recommendations for various applications in [Table 68](#).

**Table 68: Recommendations for Various Applications**

| Application   | Settings   |
|---|--|
| Low-inertia applications<br>$I_{Load}/I_{Motor} < 5$      | Increase <i>parameter 1-17 Voltage Filter Time Const.</i> by factor 5–10.<br>Reduce <i>parameter 1-14 Damping Gain</i> .<br>Reduce <i>parameter 1-66 Min.Current at Low Speed (&lt;100%)</i> .   |
| Low-inertia applications<br>$50 > I_{Load}/I_{Motor} > 5$ | Keep the default values.   |
| High-inertia applications<br>$I_{Load}/I_{Motor} > 50$    | Increase <i>parameter 1-14 Damping Gain</i> , <i>parameter 1-15 Low Speed Filter Time Const.</i> , and <i>parameter 1-16 High Speed Filter Time Const.</i>   |
| High load at low speed <30%<br>(rated speed)              | Increase <i>parameter 1-17 Voltage filter time const.</i> Increase <i>parameter 1-66 Min. Current at Low Speed</i> to adjust the starting torque. 100% current provides nominal torque as starting torque. This parameter is independent of <i>parameter 30-20 High Starting Torque Time [s]</i> and <i>parameter 30-21 High Starting Torque Current [%]</i> . Working at a current level higher than 100% for a prolonged time can cause the motor to overheat. |

If the motor starts oscillating at a certain speed, increase *parameter 1-14 Damping Gain*. Increase the value in small steps. Depending on the motor, this parameter can be set to 10–100% higher than the default value.

#### Application-specific adjustment when running flux

Flux control principle is the preferred control principle for optimum shaft performance in dynamic applications. Perform an AMA because this control mode requires precise motor data. Depending on the application, further adjustments may be required.

See [5.2.2.1 Asynchronous Motor Setup](#) for application-specific recommendations.

### 5.2.2.3 SynRM Motor Setup with VVC+

This section describes how to set up a SynRM motor with VVC+.

## NOTICE

The SmartStart wizard covers the basic configuration of SynRM motors.

#### 5.2.2.3.1 SynRM Initial Programming

##### Procedure

1. Select [5] *Sync. Reluctance* in *parameter 1-10 Motor Construction* to activate SynRM motor operation.

#### 5.2.2.3.2 SynRM Programming Motor Data

After performing the initial programming steps, the SynRM motor-related parameters in *parameter groups 1-2\* Motor Data*, *1-3\* Adv. Motor Data*, and *1-4\* Adv. Motor Data II* are active. Find the required motor data on the motor nameplate and in the motor data sheet.

##### Procedure

1. Program in the following order:

- a. *Parameter 1-23 Motor Frequency.*
  - b. *Parameter 1-24 Motor Current.*
  - c. *Parameter 1-25 Motor Nominal Speed.*
  - d. *Parameter 1-26 Motor Cont. Rated Torque.*
2. Run a complete AMA.
- Select [1] *Enable Complete AMA* in *parameter 1-29 Automatic Motor Adaptation (AMA)*, or
  - Enter the following manually:
    - Parameter 1-30 Stator Resistance (Rs).*
    - Parameter 1-37 d-axis Inductance (Ld).*
    - Parameter 1-44 d-axis Inductance Sat. (LdSat).*
    - Parameter 1-45 q-axis Inductance Sat. (LqSat).*
    - Parameter 1-48 Inductance Sat. Point.*

### 5.2.2.3.3 Application-specific Adjustment when Running VVC+ with SynRM Motors

Start the motor at nominal speed. If the application does not run well, check the VVC+ SynRM settings.

| Application   | Settings   |
|---|--|
| Low-inertia applications<br>$I_{Load}/I_{Motor} < 5$      | Increase <i>parameter 1-17 Voltage filter time const.</i> by factor 5–10.<br>Reduce <i>parameter 1-14 Damping Gain</i> .<br>Reduce <i>parameter 1-66 Min. Current at Low Speed (&lt;100%)</i> .  |
| Low-inertia applications<br>$50 > I_{Load}/I_{Motor} > 5$ | Keep the default values.   |
| High-inertia applications<br>$I_{Load}/I_{Motor} > 50$    | Increase <i>parameter 1-14 Damping Gain</i> , <i>parameter 1-15 Low Speed Filter Time Const.</i> , and <i>parameter 1-16 High Speed Filter Time Const.</i>   |
| High-load at low speed<br><30% (rated speed)              | Increase <i>parameter 1-17 Voltage filter time const.</i> Increase <i>parameter 1-66 Min. Current at Low Speed</i> to adjust the starting torque. 100% current provides nominal torque as starting torque. Working at a current level higher than 100% for a prolonged time can cause the motor to overheat.   |
| Dynamic applications                                      | Increase <i>parameter 14-41 AEO Minimum Magnetisation</i> for highly dynamic applications. Adjusting <i>parameter 14-41 AEO Minimum Magnetisation</i> ensures a good balance between energy efficiency and dynamics. Adjust <i>parameter 14-42 Minimum AEO Frequency</i> to specify the minimum frequency at which the drive should use minimum magnetization. |
| Motor sizes less than 18 kW<br>(24 hp)                    | Avoid short ramp-down times.   |

If the motor starts oscillating at a certain speed, increase *parameter 1-14 Damping Gain*. Increase the damping gain value in small steps. Depending on the motor, this parameter can be set to 10–100% higher than the default value.

### 5.2.3 1-1\* Special Settings

#### N O T I C E

The following parameter is only available in FC 302:

- *Parameter 1-11 Motor Model*

#### N O T I C E

The parameters within this parameter group cannot be adjusted while the motor is running.



Parameter 1-10 Motor Construction

Table 69: Parameter 1-10 Motor Construction

| 1-10 Motor Construction      |                        |                                |
|------------------------------|------------------------|--------------------------------|
| Default value: [0] Asynchron | Parameter type: Option | Setup: All setups              |
| Conversion index: –          | Data type: Uint8       | Change during operation: False |

Select the motor design type.

**NOTICE**

FC 301 allows only selection of induction motors.

| Option | Name                | Description   |
|--------|---------------------|---|
| [0]*   | Asynchron           | Use for ASM/IM motors.  |
| [1]    | PM, non salient SPM | <p style="text-align: center;"><b>NOTICE</b></p> <p>This option is only available in FC 302.</p> <p>Use for SPM motors, surface-mounted magnet. PM motors are divided into 2 groups, with either surface-mounted (SPM)/non-salient magnets or interior-mounted (IPM)/ salient magnets.</p>  |
| [2]    | PM, salient IPM     | <p style="text-align: center;"><b>NOTICE</b></p> <p>This option is only available in FC 302.</p> <p>Use for IPM motors, interior-mounted magnet. PM motors are divided into 2 groups, with either surface-mounted (SPM)/non-salient magnets or interior-mounted (IPM)/ salient magnets.</p> |
| [5]    | SynRM               | Use for SynRM, synchronous reluctance motors.   |
| [6]    | PMaSynRM            | Use for PMaSynRM, Permanent Magnet assisted synchronous reluctance motors.  |

Parameter 1-11 Motor Model

Table 70: Parameter 1-11 Motor Model

| 1-11 Motor Model            |                        |                                |
|-----------------------------|------------------------|--------------------------------|
| Default value: Size related | Parameter type: Option | Setup: All setups              |
| Conversion index: –         | Data type: Uint8       | Change during operation: False |

Automatically sets the factory values for the selected motor. If the default value [1] *Std. Asynchron* is used, determine settings manually according to the selection in *parameter 1-10 Motor Construction*.

**NOTICE**

There are no models available for SynRM motors.

| Option | Name                 | Description   |
|--------|----------------------|---|
| [1]    | Std. asynchron       | Default motor model when [0] <i>Asynchron</i> is selected in <i>parameter 1-10 Motor Construction</i> .   |
| [2]    | Std. PM, non salient | Selectable when [1] <i>PM, non-salient SPM</i> is selected in <i>parameter 1-10 Motor Construction</i> .  |
| [3]    | Std. PM salient      |   |
| [10]   | Danfoss OGD LA10     | Selectable when [1] <i>PM, non-salient SPM</i> is selected in <i>parameter 1-10 Motor Construction</i> . Only available for T5 in 1.5–3 kW. Settings are loaded automatically for this specific motor.  |
| [11]   | Danfoss OGD V210     | Selectable when [1] <i>PM, non-salient SPM</i> is selected in <i>parameter 1-10 Motor Construction</i> . Only available for T5 in 0.75–3 kW. Settings are loaded automatically for this specific motor. |

Parameter 1-14 Damping Gain

Table 71: Parameter 1-14 Damping Gain

| 1-14 Damping Gain   |                                 |                               |
|---------------------|---------------------------------|-------------------------------|
| Default value: 140% | Parameter type: Range, 0 - 250% | Setup: All setups             |
| Conversion index: 0 | Data type: Int16                | Change during operation: True |

The damping gain stabilizes the PM machine to run smoothly and with stability. The value of damping gain controls the dynamic performance of the PM machine. High damping gain gives high dynamic performance and low damping gain gives low dynamic performance. The dynamic performance is related to the machine data and load type. If the damping gain is too high or low, the control becomes unstable.

Parameter 1-15 Low Speed Filter Time Const.

Table 72: Parameter 1-15 Low Speed Filter Time Const.

| 1-15 Low Speed Filter Time Const. |                                    |                               |
|-----------------------------------|------------------------------------|-------------------------------|
| Default value: Size related       | Parameter type: Range, 0.01 - 20 s | Setup: All setups             |
| Conversion index: -2              | Data type: Uint16                  | Change during operation: True |

The time constant is used below 10% rated speed. Obtain quick control through a short dampening time constant. However, if this value is too short, the control becomes unstable.

Parameter 1-16 High Speed Filter Time Const.

Table 73: Parameter 1-16 High Speed Filter Time Const.

| 1-16 High Speed Filter Time Const. |                                    |                               |
|------------------------------------|------------------------------------|-------------------------------|
| Default value: Size related        | Parameter type: Range, 0.01 - 20 s | Setup: All setups             |
| Conversion index: -2               | Data type: Uint16                  | Change during operation: True |

The time constant is used above 10% rated speed. Obtain quick control through a short dampening time constant. However, if this value is too short, the control becomes unstable.

Parameter 1-17 Voltage Filter Time Const.

Table 74: Parameter 1-17 Voltage Filter Time Const.

| 1-17 Voltage Filter Time Const. |                                    |                               |
|---------------------------------|------------------------------------|-------------------------------|
| Default value: Size related     | Parameter type: Range, 0.001 - 2 s | Setup: All setups             |
| Conversion index: -3            | Data type: Uint16                  | Change during operation: True |

Reduces the influence of high frequency ripple and system resonance in the calculation of supply voltage. Without this filter, the ripples in the currents can distort the calculated voltage and affect the stability of the system.

## Parameter 1-18 Min. Current at No Load

Table 75: Parameter 1-18 Min. Current at No Load

| 1-18 Min. Current at No Load |                                |                               |
|------------------------------|--------------------------------|-------------------------------|
| Default value: 0%            | Parameter type: Range, 0 - 50% | Setup: All setups             |
| Conversion index: 0          | Data type: Uint16              | Change during operation: True |

Adjust this parameter to achieve a smoother motor operation.

## 5.2.4 1-2\* Motor Data

This parameter group contains input data from the nameplate on the connected motor.

### N O T I C E

Changing the value of these parameters affects the setting of other parameters.

### N O T I C E

The following parameters have no effect when *parameter 1-10 Motor Construction* is set to [1] PM, non-salient SPM, [2] PM, salient IPM, [5] Sync. Reluctance:

- Parameter 1-20 Motor Power [kW]
- Parameter 1-21 Motor Power [HP]
- Parameter 1-22 Motor Voltage
- Parameter 1-23 Motor Frequency

## Parameter 1-20 Motor Power [kW]

Table 76: Parameter 1-20 Motor Power [kW]

| 1-20 Motor Power [kW]       |  |                                |
|-----------------------------|--|--------------------------------|
| Default value: Size related | Parameter type: Range, 0.09 - 3000.00 kW | Setup: All setups              |
| Conversion index: -2        | Data type: Uint32                        | Change during operation: False |

### N O T I C E

This parameter cannot be adjusted while the motor is running.

Enter the nominal motor power in kW according to the motor nameplate data. The default value corresponds to the nominal rated output of the drive. This parameter is visible in the LCP if *parameter 0-03 Regional Settings* is set to [0] International.

## Parameter 1-21 Motor Power [HP]

Table 77: Parameter 1-21 Motor Power [HP]

| 1-21 Motor Power [HP]       |  |                                |
|-----------------------------|--|--------------------------------|
| Default value: Size related | Parameter type: Range, 0.09 - 3000.00 hp | Setup: All setups              |
| Conversion index: -2        | Data type: Uint32                        | Change during operation: False |

Enter the nominal motor power in hp according to the motor nameplate data. The default value corresponds to the nominal rated output of the drive. This parameter is visible in the LCP if *parameter 0-03 Regional Settings* is set to [1] North America.

Parameter 1-22 Motor Voltage

Table 78: Parameter 1-22 Motor Voltage

| 1-22 Motor Voltage          |                                    |                                |
|-----------------------------|------------------------------------|--------------------------------|
| Default value: Size related | Parameter type: Range, 10 - 1000 V | Setup: All setups              |
| Conversion index: 0         | Data type: Uint16                  | Change during operation: False |

**N O T I C E**

Setting this parameter sets the following parameters to their default settings:

- Parameter 1-15 Low Speed Filter Time Const.
- Parameter 1-16 High Speed Filter Time Const.
- Parameter 1-17 Voltage Filter Time Const.
- Parameter 1-24 motor Current
- Parameter 1-30 Stator Resistance (Rs)
- Parameter 1-31 Rotor Resistance (Rr)
- Parameter 1-33 Stator Leakage Reactance (X1)
- Parameter 1-34 Rotor Leakage Reactance (X2)
- Parameter 1-35 Main Reactance (Xh)
- Parameter 1-36 Iron Loss Resistance (Rfe)
- Parameter 4-18 Current Limit
- Parameter 14-31 Current Lim Ctrl, Integration Time
- Parameter 14-43 Motor Cosphi
- Parameter 16-36 Inv. Nom. Current
- Parameter 16-37 Inv. Max. Current
- Parameter 45-33 Alarm High
- Parameter 45-62 Load Threshold

Enter the nominal motor voltage according to the motor nameplate data. The default value corresponds to the nominal rated output of the unit.

Parameter 1-23 Motor Frequency

Table 79: Parameter 1-23 Motor Frequency

| 1-23 Motor Frequency |                                     |                                |
|----------------------|-------------------------------------|--------------------------------|
| Default value: 50 Hz | Parameter type: Range, 20 - 1000 Hz | Setup: All setups              |
| Conversion index: 0  | Data type: Uint16                   | Change during operation: False |

**N O T I C E**

From software version 6.72 onwards, the output frequency of the drive is limited to 590 Hz.

**NOTICE**

Setting this parameter sets the following parameters to their default settings:

- Parameter 1-15 Low Speed Filter Time Const.
- Parameter 1-16 High Speed Filter Time Const.
- Parameter 1-17 Voltage Filter Time Const.
- Parameter 1-24 motor Current
- Parameter 1-30 Stator Resistance (Rs)
- Parameter 1-31 Rotor Resistance (Rr)
- Parameter 1-33 Stator Leakage Reactance (X1)
- Parameter 1-34 Rotor Leakage Reactance (X2)
- Parameter 1-35 Main Reactance (Xh)
- Parameter 1-36 Iron Loss Resistance (Rfe)
- Parameter 4-18 Current Limit
- Parameter 14-31 Current Lim Ctrl, Integration Time
- Parameter 14-43 Motor Cosphi
- Parameter 16-36 Inv. Nom. Current
- Parameter 16-37 Inv. Max. Current
- Parameter 45-33 Alarm High
- Parameter 45-62 Load Threshold

Select the motor frequency value from the motor nameplate data. If a value other than 50 Hz or 60 Hz is selected, adapt the load-independent settings in *parameter 1-50 Motor Magnetisation at Zero Speed* to *parameter 1-53 Model Shift Frequency*. For 87 Hz operation with 230/400 V motors, set the nameplate data for 230 V/50 Hz. To run at 87 Hz, adapt *parameter 4-13 Motor Speed High Limit [RPM]* and *parameter 3-03 Maximum Reference*.

**Parameter 1-24 Motor Current**

**Table 80: Parameter 1-24 Motor Current**

| 1-24 Motor Current          |   |                                |
|-----------------------------|---|--------------------------------|
| Default value: Size related | Parameter type: Range, 0.1 - 10000.00 A | Setup: All setups              |
| Conversion index: -2        | Data type: Uint32                       | Change during operation: False |

**NOTICE**

This parameter cannot be adjusted while the motor is running.

**NOTICE**

Setting this parameter sets the following parameters to their default settings:

- Parameter 1-15 Low Speed Filter Time Const.
- Parameter 1-16 High Speed Filter Time Const.
- Parameter 1-17 Voltage Filter Time Const.
- Parameter 1-30 Stator Resistance (Rs)
- Parameter 1-31 Rotor Resistance (Rr)
- Parameter 1-33 Stator Leakage Reactance (X1)
- Parameter 1-34 Rotor Leakage Reactance (X2)
- Parameter 1-35 Main Reactance (Xh)
- Parameter 1-36 Iron Loss Resistance (Rfe)
- Parameter 4-18 Current Limit
- Parameter 14-31 Current Lim Ctrl, Integration Time
- Parameter 14-43 Motor Cosphi
- Parameter 45-33 Alarm High
- Parameter 45-62 Load Threshold

Enter the nominal motor current value from the motor nameplate data. The data is used for calculating torque, motor overload protection, and so on.

**Parameter 1-25 Motor Nominal Speed**

**Table 81: Parameter 1-25 Motor Nominal Speed**

| 1-25 Motor Nominal Speed    |                                       |                                |
|-----------------------------|---------------------------------------|--------------------------------|
| Default value: Size related | Parameter type: Range, 10 - 60000 RPM | Setup: All setups              |
| Conversion index: 67        | Data type: Uint16                     | Change during operation: False |

**NOTICE**

This parameter cannot be adjusted while the motor is running.

**NOTICE**

Changing this parameter will affect settings of other parameters.

Enter the nominal motor speed value from the motor nameplate data. The data is used for calculating motor compensations.

$$n_{m,n} = n_s - n_{slip}$$

**Parameter 1-26 Motor Cont. Rated Torque**

**Table 82: Parameter 1-26 Motor Cont. Rated Torque**

| 1-26 Motor Cont. Rated Torque |   |                                |
|-------------------------------|---|--------------------------------|
| Default value: Size related   | Parameter type: Range, 0.1 - 10000.0 Nm | Setup: All setups              |
| Conversion index: -1          | Data type: Uint32                       | Change during operation: False |

**NOTICE**

Changing this parameter sets certain other parameters to their default settings.

Enter the value from the motor nameplate data. The default value corresponds to the nominal rated output. This parameter is available when *parameter 1-10 Motor Construction* is set to [1] PM, non-salient SPM, that is, the parameter is valid for PM and non-salient SPM motors only.

#### Parameter 1-29 Automatic Motor Adaptation

Table 83: Parameter 1-29 Automatic Motor Adaptation (AMA)

| 1-29 Automatic Motor Adaptation (AMA) |                        |                                |
|---------------------------------------|------------------------|--------------------------------|
| Default value: [0] Off                | Parameter type: Option | Setup: All setups              |
| Conversion index: –                   | Data type: Uint8       | Change during operation: False |

### NOTICE

This parameter cannot be adjusted while the motor is running.

The AMA function optimizes dynamic motor performance by automatically optimizing the advanced motor parameters (*parameter 1-30 Stator Resistance (Rs)* to *parameter 1-35 Main Reactance (Xh)*) on a cold motor at standstill. Activate the AMA function by pressing [Hand On] after selecting [1] *Enable Complete AMA* or [2] *Enable Reduced AMA*. If an LC filter is used between the drive and the motor, always select [2] *Enable Reduced AMA*. See also the *section Automatic Motor Adaptation* in the Design Guide. After a normal sequence, the display reads: *Press [OK] to finish AMA*. After pressing [OK], the drive is ready for operation.

### NOTICE

Ensure that a value is set in *parameter 14-43 Motor Cosphi* before running AMA II.

| Option | Name                   | Description   |
|--------|------------------------|---|
| [0]*   | Off                    |   |
| [1]    | Enable complete AMA    | <p>Performs</p> <ul style="list-style-type: none"> <li>• AMA of the stator resistance <math>R_s</math></li> <li>• The rotor resistance <math>R_r</math></li> <li>• The stator leakage reactance <math>X_1</math></li> <li>• The rotor leakage reactance <math>X_2</math>, and</li> <li>• The main reactance <math>X_h</math></li> </ul> <p>Do <b>not</b> select this option if an LC filter is used between the drive and the motor. For best performance, it is recommended to obtain the advanced motor data from the motor manufacturer to enter into <i>parameter 1-31 Rotor Resistance (Rr)</i> through <i>parameter 1-36 Iron Loss Resistance (Rfe)</i>. Complete AMA cannot be performed on permanent magnet motors.</p> |
| [2]    | Enable Reduced AMA     | Performs a reduced AMA of the stator resistance $R_s$ in the system only. This option is available for standard asynchronous motors and non-salient PM motors.  |
| [3]    | Enable reduced AMA II  | Performs AMA of the stator resistance $R_s$ , the rotor resistance $R_r$ , the stator leakage reactance $X_1$ , the rotor leakage reactance $X_{21}$ , and the main reactance $X_h$ .   |
| [4]    | Enable reduced AMA II  | Performs a reduced AMA of the stator resistance $R_s$ in the system only. Select this option if an LC filter is used between the drive and the motor. The AMA II is a variant of AMA, based on the principles of the torque calibration. It is recommended for special motors (for example S3) and high-power motors.   |
| [5]    | Enable rotating AMA II | Performs rotation with 60% of nominal speed in Flux Sensorless with soft PID independent of selection in <i>parameter 1-01 Motor Control Principle</i> . Measures Back EMF on PM motors and re-measures main reactance  |

| Option | Name                | Description  |
|--------|---------------------|--|
|        |                     | (X <sub>H</sub> ) on induction motors. Ensure that the motor poles specified in <i>parameter 1-39 Motor Poles</i> are correct for accurate back EMF measurement.   |
| [6]    | Enable 360° turn OL | <p><b>Sensorless:</b> Performs a 360 degree test run in sensorless mode to verify the number of motor poles specified in <i>parameter 1-39 Motor Poles</i>.</p> <p><b>Closed loop:</b> Performs a 360 degree test run in sensorless mode to test the encoder before running in closed loop. The speed is set in <i>parameter 3-19 Jog Speed [RPM]</i>. During the test run, the direction of rotation is verified and the number of pulses per revolution is verified to match the configuration in <i>parameter group 17-** Motor Feedb. Option</i> or <i>parameter group 5-** Digital In/Out</i> based on the selected encoder.</p> <p>After completing the 360 degree test run, either of the following messages are shown:</p> <ul style="list-style-type: none"> <li>• Encoder/Resolver OK</li> <li>• Encoder/Resolver Fail</li> <li>• Encoder/Resolver Inverted</li> <li>• Encoder/Resolver resolution/poles low</li> <li>• Encoder/Resolver resolution/poles high</li> </ul> <p>The <i>parameter 1-41 Motor Angle Offset</i> is automatically set when using PM motor and absolute encoder or resolver.</p> |
| [7]    | Enable inertia run  | Use this option to ramp up in the mode as specified in <i>parameter 1-01 Motor Control Principle</i> . Measured inertia is set in <i>parameter 1-69 System Inertia</i> and <i>parameter 7-08 Speed PID Feed Forward Factor</i> is set to 90%.  |

NOTICE

- For the best adaptation of the drive, run AMA on a cold motor.
- AMA cannot be performed while the motor is running
- AMA cannot run with a sine-wave filter connected.

NOTICE

It is important to set *parameter group 1-2\* Motor Data* correctly, since these form part of the AMA algorithm. Perform an AMA to achieve optimum dynamic motor performance. It may take up to 10 minutes, depending on the power rating of the motor.

NOTICE

Avoid generating external torque during AMA.

NOTICE

If 1 of the settings in *parameter 1-2\* Motor Data* is changed, *parameter 1-30 Stator Resistance (Rs)* to *parameter 1-39 Motor Poles* return to default setting.

NOTICE

AMA works problem-free on 1 motor size down, typically works on 2 motor sizes down, rarely works on 3 sizes down, and never works on 4 sizes down. Keep in mind that the accuracy of the measured motor data is poorer when operating on motors smaller than the nominal drive size.



### 5.2.5 1-3\* Adv. Motor Data

#### NOTICE

The following parameters are only available in FC 302:

- Parameter 1-37 d-axis Inductance (Ld)
- Parameter 1-38 q-axis Inductance (Lq)
- Parameter 1-40 Back EMF at 1000 RPM
- Parameter 1-44 d-axis Inductance Sat. (LdSat)
- Parameter 1-45 q-axis Inductance Sat. (LqSat)
- Parameter 1-49 q-axis Inductance Sat. Point

This parameter group contains parameters related to:

- Motor nameplate load compensations.
- Application load type.
- Electronic brake function for quick stop/hold of the motor.

Ensure that the motor data in *parameter 1-30 Stator Resistance (Rs)* to *parameter 1-39 Motor Poles* matches the motor. The default settings are based on standard motor values. If the motor parameters are not set correctly, a malfunction of the drive system may occur. If the motor data is unknown, running an AMA (automatic motor adaptation) is recommended. See *parameter 1-29 Automatic Motor Adaptation (AMA)*.

*Parameter groups 1-3\* Adv. Motor Data* and *1-4\* Adv. Motor Data II* cannot be adjusted while the motor is running.

#### NOTICE

A simple check of the  $X_1 + X_h$  sum value is to divide the line-to-line motor voltage by the  $\sqrt{3}$  and divide this value by the motor no load current.  $[VL-L/\sqrt{3}]/INL = X_1 + X_h$ . These values are important to magnetize the motor properly. For high-pole motors, it is highly recommended to perform this check.

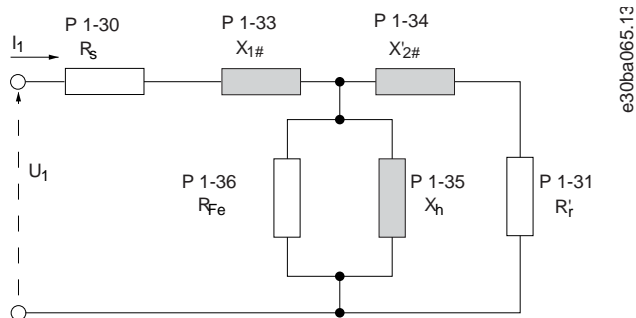

**Illustration 30: Motor Equivalent Diagram of an Asynchronous Motor**

#### Parameter 1-30 Stator Resistance (Rs)

**Table 84: Parameter 1-30 Stator Resistance (Rs)**

| 1-30 Stator Resistance (Rs) |  |                                |
|-----------------------------|--|--------------------------------|
| Default value: Size related | Parameter type: Range, 0.0140 - 140.0000 Ohm | Setup: All setups              |
| Conversion index: -4        | Data type: Uint32                            | Change during operation: False |

#### NOTICE

This parameter cannot be adjusted while the motor is running.

Set the line-to-common stator resistance value. Enter the value from a motor datasheet or perform an AMA on a cold motor.

**NOTICE**

For salient PM motors: AMA is not available. If only line-line data is available, divide the line-line value by 2 to achieve the line-to-common (star point) value. Alternatively, measure the value with an ohmmeter. This also takes the resistance of the cable into account. Divide the measured value by 2 and enter the result.

**NOTICE**

The parameter value is updated after each torque calibration if option [3] *1st start with store* or option [4] *Every start with store* is selected in *parameter 1-47 Torque Calibration*.

Parameter 1-31 Rotor Resistance (Rr)

Table 85: Parameter 1-31 Rotor Resistance (Rr)

| 1-31 Rotor Resistance (Rr)  |  |                                |
|-----------------------------|--|--------------------------------|
| Default value: Size related | Parameter type: Range, 0.0100 - 100.0000 Ohm | Setup: All setups              |
| Conversion index: -4        | Data type: Uint32                            | Change during operation: False |

**NOTICE**

*Parameter 1-31 Rotor Resistance (Rr)* has no effect when *parameter 1-10 Motor Construction* is set to [1] *PM, non-salient SPM*, [5] *SynRM*.

Set the rotor resistance value  $R_r$  to improve shaft performance using 1 of these methods:

- Run an AMA on a cold motor. The drive measures the value from the motor. All compensations are reset to 100%.
- Enter the  $R_r$  value manually. Obtain the value from the motor supplier.
- Use the  $R_r$  default setting. The drive establishes the setting based on the motor nameplate data.

Parameter 1-33 Stator Leakage Reactance (X1)

Table 86: Parameter 1-33 Stator Leakage Reactance (X1)

| 1-33 Stator Leakage Reactance (X1) |  |                                |
|------------------------------------|--|--------------------------------|
| Default value: Size related        | Parameter type: Range, 0.0400 - 400.0000 Ohm | Setup: All setups              |
| Conversion index: -4               | Data type: Uint32                            | Change during operation: False |

**NOTICE**

This parameter is only relevant for asynchronous motors.

Set the stator leakage reactance of the motor using 1 of these methods:

- Run an AMA on a cold motor. The drive measures the value from the motor.
- Enter the  $X_1$  value manually. Obtain the value from the motor supplier.
- Use the  $X_1$  default setting. The drive establishes the setting based on the motor nameplate data.

**NOTICE**

The parameter value is updated after each torque calibration if option [3] *1st start with store* or option [4] *Every start with store* is selected in *parameter 1-47 Torque Calibration*.

Parameter 1-34 Rotor Leakage Reactance (X<sub>2</sub>)Table 87: Parameter 1-34 Rotor Leakage Reactance (X<sub>2</sub>)

| 1-34 Rotor Leakage Reactance (X <sub>2</sub> ) |  |                                |
|--|--|--------------------------------|
| Default value: Size related                    | Parameter type: Range, 0.0400 - 400.0000 Ohm | Setup: All setups              |
| Conversion index: -4                           | Data type: Uint32                            | Change during operation: False |

## NOTICE

This parameter is only relevant for asynchronous motors.

Set the rotor leakage reactance of the motor using 1 of these methods:

- Run an AMA on a cold motor. The drive measures the value from the motor.
- Enter the X<sub>2</sub> value manually. Obtain the value from the motor supplier.
- Use the X<sub>2</sub> default setting. The drive establishes the setting based on the motor nameplate data.

## NOTICE

The parameter value is updated after each torque calibration if option [3] *1st start with store* or option [4] *Every start with store* is selected in *parameter 1-47 Torque Calibration*.

Parameter 1-35 Main Reactance (X<sub>h</sub>)Table 88: Parameter 1-35 Main Reactance (X<sub>h</sub>)

| 1-35 Main Reactance (X <sub>h</sub> ) |   |                                |
|---------------------------------------|---|--------------------------------|
| Default value: Size related           | Parameter type: Range, 1.0000 - 10000.0000 Ohm] | Setup: All setups              |
| Conversion index: -4                  | Data type: Uint32                               | Change during operation: False |

## NOTICE

This parameter cannot be adjusted while the motor is running.

## NOTICE

*Parameter 1-35 Main Reactance (X<sub>h</sub>)* does not have effect when *parameter 1-10 Motor Construction* is set to [1] *PM, non-salient SPM*.

Set the main reactance of the motor using 1 of these methods:

- Run an AMA on a cold motor. The drive measures the value from the motor.
- Enter the X<sub>h</sub> value manually. Obtain the value from the motor supplier.
- Use the X<sub>h</sub> default setting. The drive establishes the setting based on the motor nameplate data.

## NOTICE

The parameter value is updated after each torque calibration if option [3] *1st start with store* or option [4] *Every start with store* is selected in *parameter 1-47 Torque Calibration*.

Parameter 1-36 Iron Loss Resistance (Rfe)

Table 89: Parameter 1-36 Iron Loss Resistance (Rfe)

| 1-36 Iron Loss Resistance (Rfe) |   |                                |
|---------------------------------|---|--------------------------------|
| Default value: Size related     | Parameter type: Range, 0 - 10000.000 Ohm] | Setup: All setups              |
| Conversion index: -3            | Data type: Uint32                         | Change during operation: False |

**NOTICE**

This parameter cannot be adjusted while the motor is running.

Enter the equivalent iron loss resistance ( $R_{Fe}$ ) value to compensate for iron loss in the motor. The  $R_{Fe}$  value cannot be found by performing an AMA. The  $R_{Fe}$  value is especially important in torque control applications. If  $R_{Fe}$  is unknown, leave *parameter 1-36 Iron Loss Resistance (Rfe)* on default setting.

Parameter 1-37 d-axis Inductance (Ld)

For induction motors, stator resistance and d-axis inductance values are normally described technical specifications as between line and common (starpoint). For PM motors, they are typically described in technical specifications as between line-to-line. PM motors are typically built for start connection.

Table 90: Parameters Related to PM Motors

| Parameter  | Function   |
|--|--|
| <i>Parameter 1-30 Stator Resistance (Rs)</i> (line to common).       | This parameter gives stator winding resistance ( $R_s$ ) similar to asynchronous motor stator resistance. The stator resistance is defined for line-to-common measurement. For line-line data, where stator resistance is measured between any 2 lines, divide by 2. |
| <i>Parameter 1-37 d-axis Inductance (Ld)</i> (line to common).       | This parameter gives direct axis inductance of the PM motor. The daxis inductance is defined for phase-to-common measurement. For line-line data, where stator resistance is measured between any 2 lines, divide by 2.  |
| <i>Parameter 1-40 Back EMF at 1000 RPM RMS</i> (line to line value). | This parameter gives back EMF across stator terminal of PM motor at 1000 RPM mechanical speed specifically. It is defined between line-to-line and expressed in RMS value.   |

**NOTICE**

Motor manufacturers provide values for stator resistance (*parameter 1-30 Stator Resistance (Rs)*) and d-axis inductance (*parameter 1-37 d-axis Inductance (Ld)*) in technical specifications as between line and common (starpoint) or line between line. There is no general standard. The different setups of stator winding resistance and induction are shown in [Illustration 31](#). Danfoss AC drives always require the line-to-common value. The back EMF of a PM motor is defined as induced EMF developed across any of 2 phases of stator winding of a free-running motor. Danfoss AC drives always require the line-to-line RMS value measured at 1000 RPM, mechanical speed of rotation, see [Illustration 32](#).

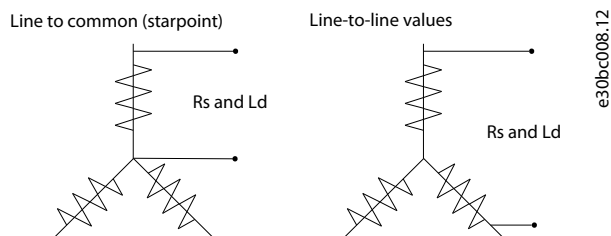

Illustration 31: Stator Winding Setups

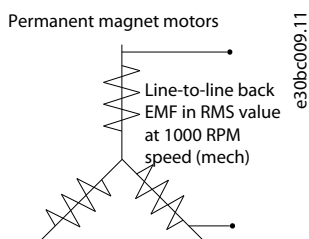

Illustration 32: Machine Parameter Definitions of Back EMF of PM Motors

Parameter 1-38 q-axis Inductance (Lq)

Table 91: Parameter 1-38 q-axis Inductance (Lq)

| 1-38 q-axis Inductance (Lq) |  |                                |
|-----------------------------|--|--------------------------------|
| Default value: Size related | Parameter type: Range, 0.001 - 1000 mH | Setup: All setups              |
| Conversion index: -6        | Data type: Int32                       | Change during operation: False |

Set the value of the q-axis inductance. See the motor datasheet.

Parameter 1-39 Motor Poles

Table 92: Parameter 1-39 Motor Poles

| 1-39 Motor Poles            |                                |                                |
|-----------------------------|--------------------------------|--------------------------------|
| Default value: Size related | Parameter type: Range, 2 - 255 | Setup: All setups              |
| Conversion index: 0         | Data type: Uint8               | Change during operation: False |

**NOTICE**

This parameter cannot be adjusted while the motor is running.

Enter the number of motor poles. The number of motor poles is always an even number as it refers to the total number of poles, not pairs of poles.

Table 93: Pole Number for Normal Speed Ranges

| Poles | ~n <sub>n</sub> @ 50 Hz | ~n <sub>n</sub> @ 60 Hz |
|-------|-------------------------|-------------------------|
| 2     | 2700–2880               | 3520–3460               |
| 4     | 1350–1450               | 1625–1730               |
| 6     | 700–960                 | 840–1153                |

The table shows the pole number for normal speed ranges of various motor types. Define motors designed for other frequencies separately. The motor pole value is always an even number because it refers to the total pole number, not pairs of poles. The drive creates the initial setting of *parameter 1-39 Motor Poles* based on *parameter 1-23 Motor Frequency* and *parameter 1-25 Motor Nominal Speed*.

Parameter 1-40 Back EMF at 1000 RPM

Table 94: Parameter 1-40 Back EMF at 1000 RPM

| 1-40 Back EMF at 1000 RPM   |                                   |                                |
|-----------------------------|-----------------------------------|--------------------------------|
| Default value: Size related | Parameter type: Range, 1 - 9000 V | Setup: All setups              |
| Conversion index: 0         | Data type: Uint16                 | Change during operation: False |

**NOTICE**

This parameter is only active when *parameter 1-10 Motor Construction* is set to options that enable PM (permanent magnet) motors.

Set the nominal back EMF for the motor when running at 1000 RPM. Back EMF is the voltage generated by a PM motor when no drive is connected and the shaft is turned externally. Back EMF is normally specified for nominal motor speed or for 1000 RPM measured between 2 lines. If the value is not available for a motor speed of 1000 RPM, calculate the correct value as follows:

$$\text{Back EMF} = (\text{Voltage} \div \text{RPM}) \times 1000$$

In an example where the voltage is 320 V and RPM is 1800, the back EMF at 1000 RPM is:

$$(320 \div 1800) \times 1000 = 178$$

**NOTICE**

When using PM motors, it is recommended to use brake resistors.

Parameter 1-44 d-axis Inductance Sat. (LdSat)

Table 95: Parameter 1-44 d-axis Inductance Sat. (LdSat)

| 1-44 d-axis Inductance Sat. (LdSat) |  |                                |
|-------------------------------------|--|--------------------------------|
| Default value: Size related         | Parameter type: Range, 0.001 - 1000 mH | Setup: All setups              |
| Conversion index: -6                | Data type: Int32                       | Change during operation: False |

This parameter corresponds to the inductance saturation of Ld. Ideally, this parameter has the same value as *parameter 1-37 d-axis Inductance (Ld)*. If the motor supplier provides an induction curve, enter the induction value at 200% of the nominal value.

Parameter 1-45 q-axis Inductance Sat. (LqSat)

Table 96: Parameter 1-45 q-axis Inductance Sat. (LqSat)

| 1-45 q-axis Inductance Sat. (LqSat) |                                    |                                |
|-------------------------------------|------------------------------------|--------------------------------|
| Default value: Size related         | Parameter type: Range, 0 - 1000 mH | Setup: All setups              |
| Conversion index: -6                | Data type: Int32                   | Change during operation: False |

This parameter corresponds to the inductance saturation of Lq. Ideally, this parameter has the same value as *parameter 1-38 q-axis Inductance (Lq)*. If the motor supplier provides an induction curve, enter the induction value at 200% of the nominal value.

Parameter 1-46 Position Detection Gain

Table 97: Parameter 1-46 Position Detection Gain

| 1-46 Position Detection Gain |                                  |                               |
|------------------------------|----------------------------------|-------------------------------|
| Default value: 120%          | Parameter type: Range, 20 - 200% | Setup: All setups             |
| Conversion index: 0          | Data type: Uint16                | Change during operation: True |

Adjusts the amplitude of the test pulse during position detection at start. Adjust this parameter to improve the position measurement.

Parameter 1-47 Torque Calibration

Table 98: Parameter 1-47 Torque Calibration

| 1-47 Torque Calibration |                        |                               |
|-------------------------|------------------------|-------------------------------|
| Default value: [0] Off  | Parameter type: Option | Setup: All setups             |
| Conversion index: -     | Data type: Uint8       | Change during operation: True |

Use this parameter to optimize the torque estimate in the full speed range. The estimated torque is based on the shaft power,  $P_{shaft} = P_m - R_s \times I^2$ . Make sure that the  $R_s$  value is correct. The  $R_s$  value in this formula is equal to the power loss in the motor, the cable, and the drive. When this parameter is active, the drive calculates the  $R_s$  value during power-up, ensuring the optimal torque estimate and optimal performance. Use this feature in cases when it is not possible to adjust *parameter 1-30 Stator Resistance (Rs)* on each drive to compensate for the cable length, drive losses, and the temperature deviation on the motor.

| Option | Name                               | Description   |
|--------|------------------------------------|---|
| [0]*   | Off                                |   |
| [1]    | 1 <sup>st</sup> start after pwr-up | Calibrates at the 1 <sup>st</sup> start-up after power-up and keeps this value until reset by a power cycle.  |
| [2]    | Every start                        | Calibrates at every start-up, compensating for a possible change in motor temperature since last start-up. The value is reset after a power cycle.  |
| [3]    | 1 <sup>st</sup> start with store   | The drive calibrates the torque at the 1 <sup>st</sup> start-up after power-up. This option is used to update motor parameters: <ul style="list-style-type: none"> <li>• <i>Parameter 1-30 Stator Resistance (Rs)</i>.</li> <li>• <i>Parameter 1-33 Stator Leakage Reactance (X1)</i>.</li> <li>• <i>Parameter 1-34 Rotor Leakage Reactance (X2)</i>.</li> <li>• <i>Parameter 1-37 d-axis Inductance (Ld)</i>.</li> </ul>   |
| [4]    | Every start with store             | The drive calibrates the torque at every start-up, compensating for a possible change in motor temperature since last start-up. This option is used to update motor parameters: <ul style="list-style-type: none"> <li>• <i>Parameter 1-30 Stator Resistance (Rs)</i>.</li> <li>• <i>Parameter 1-33 Stator Leakage Reactance (X1)</i>.</li> <li>• <i>Parameter 1-34 Rotor Leakage Reactance (X2)</i>.</li> <li>• <i>Parameter 1-37 d-axis Inductance (Ld)</i>.</li> </ul> |

Parameter 1-48 d-axis Inductance Sat. Point

Table 99: Parameter 1-48 d-axis Inductance Sat. Point

| 1-48 d-axis Inductance Sat. Point |                                 |                               |
|-----------------------------------|---------------------------------|-------------------------------|
| Default value: Size related       | Parameter type: Range, 1 - 500% | Setup: All setups             |
| Conversion index: 0               | Data type: Int16                | Change during operation: True |

**NOTICE**

Run an AMA to set the value of this parameter. Edit the value manually only when the application requires a value other than determined by AMA.

Select the d-axis inductance saturation point. The drive uses this value to optimize the performance of SynRM motors. Select the value that matches the point where the inductance equals the mean value of *parameter 1-37 d-axis Inductance (Ld)* and *parameter 1-44 d-axis Inductance Sat. (LdSat)*, as percentage of nominal current.

Parameter 1-49 q-axis Inductance Sat. Point

Table 100: Parameter 1-49 q-axis Inductance Sat. Point

| 1-49 q-axis Inductance Sat. Point |                                 |                                |
|-----------------------------------|---------------------------------|--------------------------------|
| Default value: Size related       | Parameter type: Range, 1 - 200% | Setup: All setups              |
| Conversion index: 0               | Data type: Uint16               | Change during operation: False |

**NOTICE**

Run an AMA to set the value of this parameter. Edit the value manually only when the application requires a value other than determined by AMA.

Enter the q-axis inductance saturation point. The drive uses this value to optimize the performance of IPM motors. Select the value that matches the point where the inductance equals the average value of *parameter 1-38 q-axis Inductance (Lq)* and *parameter 1-45 q-axis Inductance Sat. (LqSat)*, as a percentage of nominal current.

### 5.2.6 1-5\* Load Indep. Setting

**NOTICE**

The following parameter is only available in FC 302:

- *Parameter 1-53 Model Shift Frequency*

This parameter group contains parameters related to:

- Motor nameplate load compensations.
- Application load type.
- Electronic brake function for quick stop/hold of the motor.

#### Parameter 1-50 Motor Magnetization at Zero Speed

**Table 101: Parameter 1-50 Motor Magnetization at Zero Speed**

| 1-50 Motor Magnetization at Zero Speed |                                 |                               |
|--|---------------------------------|-------------------------------|
| Default value: 100%                    | Parameter type: Range, 0 - 300% | Setup: All setups             |
| Conversion index: 0                    | Data type: Uint16               | Change during operation: True |

**NOTICE**

*Parameter 1-50 Motor Magnetisation at Zero Speed* has no effect when *parameter 1-10 Motor Construction = [1] PM, nonsalient SPM*.

Use this parameter along with *parameter 1-51 Min Speed Normal Magnetising [RPM]* to obtain a different thermal load on the motor when running at low speed. Enter a value which is a percentage of the rated magnetizing current. If the setting is too low, the torque on the motor shaft may be reduced.

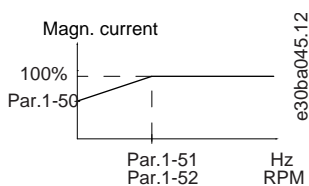

**Illustration 33: Motor Magnetization**

#### Parameter 1-51 Min Speed Normal Magnetising [RPM]

**Table 102: Parameter 1-51 Min Speed Normal Magnetising [RPM]**

| 1-51 Min Speed Normal Magnetising [RPM] |                                     |                               |
|---|-------------------------------------|-------------------------------|
| Default value: Size related             | Parameter type: Range, 10 - 600 RPM | Setup: All setups             |
| Conversion index: 67                    | Data type: Uint16                   | Change during operation: True |



**NOTICE**

Parameter 1-51 Min Speed Normal Magnetising [RPM] has no effect when parameter 1-10 Motor Construction = [1] PM, nonsalient SPM.

Set the required speed for normal magnetizing current. If the speed is set lower than the motor slip speed, parameter 1-50 Motor Magnetisation at Zero Speed and parameter 1-51 Min Speed Normal Magnetising [RPM] are of no significance. Use this parameter along with parameter 1-50 Motor Magnetisation at Zero Speed.

Parameter 1-52 Min Speed Normal Magnetising [Hz]

Table 103: Parameter 1-52 Min Speed Normal Magnetising [Hz]

| 1-52 Min Speed Normal Magnetising [Hz] |                                     |                               |
|--|-------------------------------------|-------------------------------|
| Default value: Size related            | Parameter type: Range, 0 - 250.0 Hz | Setup: All setups             |
| Conversion index: -1                   | Data type: Uint16                   | Change during operation: True |

**NOTICE**

Parameter 1-52 Min Speed Normal Magnetising [Hz] has no effect when parameter 1-10 Motor Construction = [1] PM, non-salient SPM.

Set the required frequency for normal magnetizing current. If the frequency is set lower than the motor slip frequency, parameter 1-50 Motor Magnetisation at Zero Speed is inactive. Use this parameter along with parameter 1-50 Motor Magnetisation at Zero Speed.

Parameter 1-53 Model Shift Frequency

Table 104: Parameter 1-53 Model Shift Frequency

| 1-53 Model Shift Frequency  |                                    |                                |
|-----------------------------|------------------------------------|--------------------------------|
| Default value: Size related | Parameter type: Range, 4 - 18.0 Hz | Setup: All setups              |
| Conversion index: -1        | Data type: Uint16                  | Change during operation: False |

**NOTICE**

This parameter cannot be adjusted while the motor is running.

**Flux model shift:** Enter the frequency value for shifting between 2 models for determining motor speed. Select the value based on settings in parameter 1-00 Configuration Mode and parameter 1-01 Motor Control Principle. There are the following options:

- Shift between flux model 1 and flux model 2.
- Shift between variable current mode and flux model 2.
- No shift between models at low speed if parameter 40-50 Flux Sensorless Model Shift is set to option [0] Off.

**Flux model 1 - flux model 2:** This model is used when parameter 1-00 Configuration Mode is set to [1] Speed closed loop or [2] Torque, and parameter 1-01 Motor Control Principle is set to [3] Flux w/motor feedback. With this parameter, it is possible to make an adjustment of the shifting point where the drive changes between flux model 1 and flux model 2, which is useful in some sensitive speed and torque control applications.

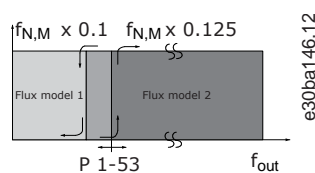

Illustration 34: Example of Parameter 1-00 Configuration Mode = [1] Speed closed loop or [2] Torque and parameter 1-01 Motor Control Principle = [3] Flux w/motor feedback

**Variable current - flux model - sensorless:** This model is used when parameter 1-00 Configuration Mode is set to [0] Speed open loop and parameter 1-01 Motor Control Principle is set to [2] Flux sensorless. In speed open loop in flux mode, the speed is determined from

the current measurement. Below  $f_{norm} \times 0.1$ , the drive runs on a variable current model. Above  $f_{norm} \times 0.125$  the drive runs on a flux model.

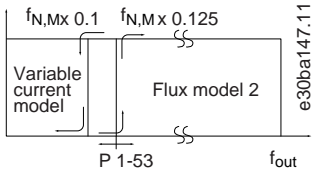

Illustration 35: Parameter 1-00 Configuration Mode = [0] Speed open loop, parameter 1-01 Motor Control Principle = [2] Flux sensorless

Parameter 1-54 Voltage Reduction in Fieldweakening

Table 105: Parameter 1-54 Voltage reduction in fieldweakening

| 1-54 Voltage reduction in fieldweakening |                                    |                               |
|--|------------------------------------|-------------------------------|
| Default value: 0 V                       | Parameter type: Range, -50 - 100 V | Setup: All setups             |
| Conversion index: 0                      | Data type: Int8                    | Change during operation: True |

The value of this parameter reduces the maximum voltage available for the flux of the motor in field weakening, providing more voltage for torque. Increasing the value increases the risk of stalling at high speed. When reducing the voltage below 0, the output voltage is increased and at some point the current controller is forced into "Voltage Limit".

Parameter 1-55 U/f Characteristic - U

Table 106: Parameter 1-55 U/f Characteristic - U

| 1-55 U/f Characteristic - U |  |                               |
|-----------------------------|--|-------------------------------|
| Default value: Size related | Parameter type: Range, 0 - 1000 V, Array [6] | Setup: All setups             |
| Conversion index: -1        | Data type: Uint16                            | Change during operation: True |

Enter the voltage at each frequency point to manually form a U/f characteristic matching the motor. The frequency points are defined in *parameter 1-56 U/f Characteristic - F*. This parameter is an array parameter [0-5] and is only accessible when *parameter 1-01 Motor Control Principle* is set to [0] U/f.

Parameter 1-56 U/f Characteristic - F

Table 107: Parameter 1-56 U/f Characteristic - F

| 1-56 U/f Characteristic - F |  |                               |
|-----------------------------|--|-------------------------------|
| Default value: Size related | Parameter type: Range, 0 - 1000.0 V, Array [6] | Setup: All setups             |
| Conversion index: -1        | Data type: Uint16                              | Change during operation: True |

Enter the frequency points to form a U/f characteristic manually matching the motor. The voltage at each point is defined in *parameter 1-55 U/f Characteristic - U*. This parameter is an array parameter [0-5] and is only accessible when *parameter 1-01 Motor Control Principle* is set to [0] U/f.

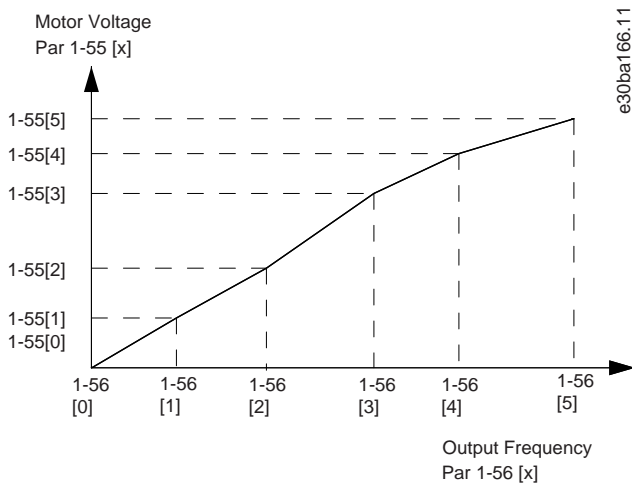

Illustration 36: U/f Characteristic

Parameter 1-57 Torque Estimation Time Constant

Table 108: Parameter 1-57 Torque Estimation Time Constant

| 1-57 Torque Estimation Time Constant |                                     |                               |
|--------------------------------------|-------------------------------------|-------------------------------|
| Default value: 150 ms                | Parameter type: Range, 50 - 1000 ms | Setup: All setups             |
| Conversion index: -3                 | Data type: Uint16                   | Change during operation: True |

**NOTICE**

This parameter is only valid with software version 48.XX.

Enter the time constant for the torque estimation below model change point in flux sensorless control principle.

Parameter 1-58 Flying Start Test Pulses Current

Table 109: Parameter 1-58 Flying Start Test Pulses Current

| 1-58 Flying Start Test Pulses Current |                                 |                                |
|---------------------------------------|---------------------------------|--------------------------------|
| Default value: Size related           | Parameter type: Range, 0 - 200% | Setup: All setups              |
| Conversion index: 0                   | Data type: Uint16               | Change during operation: False |

**NOTICE**

This parameter is only available in VVC+.

**NOTICE**

This parameter has effect on PM motors only.

Sets the current level for the flying start test pulses that are used to detect the motor direction. 100% means  $I_{m,n}$ . Adjust the value to be high enough to avoid noise influence, but low enough to avoid affecting the accuracy (current must be able to drop to 0 before the next pulse). Reduce the value to reduce the generated torque. Default is 30% for asynchronous motors, but may vary for PM motors. For adjusting PM motors, the value tunes for back EMF and d-axis inductance of the motor.

Parameter 1-59 Flying Start Test Pulses Frequency

Table 110: Parameter 1-59 Flying Start Test Pulses Frequency

| 1-59 Flying Start Test Pulses Frequency |                                 |                                |
|---|---------------------------------|--------------------------------|
| Default value: Size related             | Parameter type: Range, 0 - 500% | Setup: All setups              |
| Conversion index: 0                     | Data type: Uint16               | Change during operation: False |

Asynchronous motor: Set the frequency of the flying start test pulses that are used to detect the motor direction. For asynchronous motors, the value 100% means that the slip is doubled. Increase this value to reduce the generated torque. For synchronous motors, this value is the percentage  $n_{m,n}$  of the free-running motor. Above this value, flying start is always performed. Below this value, the start mode is selected in *parameter 1-70 Start Mode*.

5.2.7 1-6\* Load Depend. Setting

**NOTICE**

The following parameters are only available in FC 302:

- *Parameter 1-66 Min. Current at Low Speed*
- *Parameter 1-67 Load Type*
- *Parameter 1-68 Motor Inertia*
- *Parameter 1-69 System Inertia*

Parameter 1-60 Low Speed Load Compensation

Table 111: Parameter 1-60 Low Speed Load Compensation

| 1-60 Low Speed Load Compensation |                                 |                               |
|----------------------------------|---------------------------------|-------------------------------|
| Default value: 100%              | Parameter type: Range, 0 - 300% | Setup: All setups             |
| Conversion index: 0              | Data type: Int16                | Change during operation: True |

Enter the % value to compensate voltage in relation to load when the motor is running at low speed and obtain the optimum U/f characteristic. The motor size determines the frequency range within which this parameter is active.

| Motor size               | Changeover |
|--------------------------|------------|
| 0.25–7.5 kW              | <10 Hz     |
| 11–45 kW                 | <5 Hz      |
| 55–maximum power size kW | <3–4 Hz    |

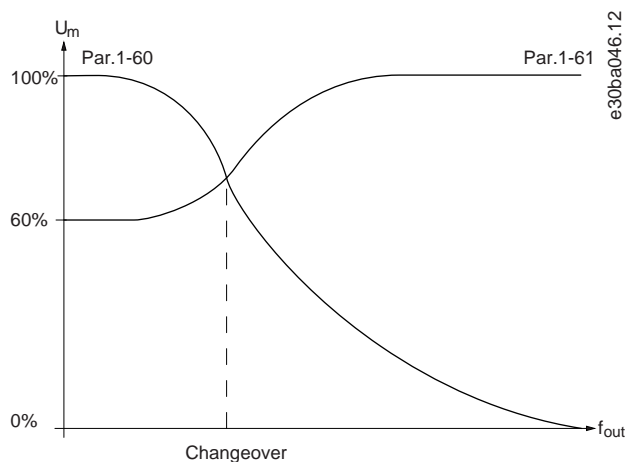

Illustration 37: Changeover

Parameter 1-61 High Speed Load Compensation

Table 112: Parameter 1-61 High Speed Load Compensation

| 1-61 High Speed Load Compensation |                                 |                               |
|-----------------------------------|---------------------------------|-------------------------------|
| Default value: 100%               | Parameter type: Range, 0 - 300% | Setup: All setups             |
| Conversion index: 0               | Data type: Int16                | Change during operation: True |

Enter the % value to compensate voltage in relation to load when the motor is running at high speed and obtain the optimum U/f characteristic. The motor size determines the frequency range within which this parameter is active.

| Motor size               | Changeover |
|--------------------------|------------|
| 0.25–7.5 kW              | >10 Hz     |
| 11–45 kW                 | >5 Hz      |
| 55–maximum power size kW | >3–4       |

Parameter 1-62 Slip Compensation

Table 113: Parameter 1-62 Slip Compensation

| 1-62 Slip Compensation      |                                    |                               |
|-----------------------------|------------------------------------|-------------------------------|
| Default value: Size related | Parameter type: Range, -500 - 500% | Setup: All setups             |
| Conversion index: 0         | Data type: Int16                   | Change during operation: True |

Enter the % value for slip compensation to compensate for tolerances in the value of  $n_{M,N}$ . Slip compensation is calculated automatically, that is on the basis of the nominal motor speed  $n_{M,N}$ . This function is not active when *parameter 1-00 Configuration Mode* is set to [1] Speed closed loop or [2] Torque torque control with speed feedback or when *parameter 1-01 Motor Control Principle* is set to [0] U/f.

Parameter 1-63 Slip Compensation Time Constant

Table 114: Parameter 1-63 Slip Compensation Time Constant

| 1-63 Slip Compensation Time Constant |                                   |                               |
|--------------------------------------|-----------------------------------|-------------------------------|
| Default value: Size related          | Parameter type: Range, 0.05 - 5 s | Setup: All setups             |
| Conversion index: -2                 | Data type: Uint16                 | Change during operation: True |

**NOTICE**

*Parameter 1-63 Slip Compensation Time Constant has no effect when parameter 1-10 Motor Construction = [1] PM, nonsalient SPM.*

Enter the slip compensation reaction speed. A high value results in slow reaction, and a low value results in quick reaction. If low-frequency resonance problems arise, use a longer time setting.

**Parameter 1-64 Resonance Damping**

**Table 115: Parameter 1-64 Resonance Damping**

| 1-64 Resonance Damping      |                                  |                               |
|-----------------------------|----------------------------------|-------------------------------|
| Default value: Size related | Parameter type: Range, 0 - 1000% | Setup: All setups             |
| Conversion index: 0         | Data type: Uint16                | Change during operation: True |

**NOTICE**

*Parameter 1-64 Resonance Damping has no effect when parameter 1-10 Motor Construction = [1] PM, nonsalient SPM.*

Enter the resonance damping value. Set *parameter 1-64 Resonance Damping* and *parameter 1-65 Resonance Damping Time Constant* to help eliminate high-frequency resonance problems. To reduce resonance oscillation, increase the value of *parameter 1-64 Resonance Damping*.

**Parameter 1-65 Resonance Damping Time**

**Table 116: Parameter 1-65 Resonance Damping Time Constant**

| 1-65 Resonance Damping Time Constant |                                  |                               |
|--------------------------------------|----------------------------------|-------------------------------|
| Default value: 5 ms                  | Parameter type: Range, 1 - 50 ms | Setup: All setups             |
| Conversion index: -3                 | Data type: Uint8                 | Change during operation: True |

**NOTICE**

*Parameter 1-65 Resonance Damping Time Constant has no effect when parameter 1-10 Motor Construction = [1] PM, non-salient SPM.*

Set *parameter 1-64 Resonance Damping* and *parameter 1-65 Resonance Damping Time Constant* to help eliminate high-frequency resonance problems. Enter the time constant that provides the best dampening.

**Parameter 1-66 Min. Current at Low Speed**

**Table 117: Parameter 1-66 Min. Current at Low Speed**

| 1-66 Min. Current at Low Speed |                                 |                               |
|--------------------------------|---------------------------------|-------------------------------|
| Default value: Size related    | Parameter type: Range, 1 - 200% | Setup: All setups             |
| Conversion index: 0            | Data type: Uint32               | Change during operation: True |

**NOTICE**

If *parameter 40-50 Flux Sensorless Model Shift* is set to [0] Off, this parameter is ignored.

Enter the minimum motor current at low speed, see *parameter 1-53 Model Shift Frequency*. Increasing this current improves motor torque at low speed. *Parameter 1-66 Min. Current at Low Speed* is enabled when *parameter 1-00 Configuration Mode* is set to [0] Speed open loop only. The drive runs with constant current through motor for speeds below 10 Hz. For speeds above 10 Hz, the motor flux model in the drive controls the motor. *Parameter 4-16 Torque Limit Motor Mode* and/or *parameter 4-17 Torque Limit Generator Mode* automatically adjust *parameter 1-66 Min. Current at Low Speed*. The parameter with the highest value adjusts *parameter 1-66 Min. Current at Low Speed*. The current setting in *parameter 1-66 Min. Current at Low Speed* is composed of the torque generating current and the magnetizing current. **Example:** Set *parameter 4-16 Torque Limit Motor Mode* to 100% and set *parameter 4-17 Torque Limit Generator Mode* to 60%. *Parameter 1-66 Min. Current at Low Speed* automatically adjusts to about 127%, depending on the motor size.

## Parameter 1-67 Load Type

Table 118: Parameter 1-67 Load Type

| 1-67 Load Type                  |                        |                               |
|---------------------------------|------------------------|-------------------------------|
| Default value: [0] Passive load | Parameter type: Option | Setup: All setups             |
| Conversion index: –             | Data type: Uint8       | Change during operation: True |

| Option | Name         | Description  |
|--------|--------------|--|
| [0]*   | Passive load | For conveyors, fans, and pump applications.  |
| [1]    | Active load  | For hoisting applications. This option allows the drive to ramp up at 0 RPM. When [1] Active Load is selected, set <i>parameter 1-66 Min. Current at Low Speed</i> to a level which corresponds to maximum torque. |

## Parameter 1-68 Motor Inertia

Table 119: Parameter 1-68 Motor Inertia

| 1-68 Motor Inertia                |   |                                |
|-----------------------------------|---|--------------------------------|
| Default value: 0 kgm <sup>2</sup> | Parameter type: Range, 0.0000 - 10000.0000 kgm <sup>2</sup> | Setup: All setups              |
| Conversion index: -4              | Data type: Uint32   | Change during operation: False |

Enter the motor inertia to obtain an improved torque readout and therefore a better estimate of the mechanical torque on the shaft. Available in flux control principle only.

## Parameter 1-69 System Inertia

Table 120: Parameter 1-69 System Inertia

| 1-69 System Inertia         |   |                                |
|-----------------------------|---|--------------------------------|
| Default value: Size related | Parameter type: Range, 0000 - 10000.0000 kgm <sup>2</sup> | Setup: All setups              |
| Conversion index: -4        | Data type: Uint32   | Change during operation: False |

## NOTICE

This parameter cannot be adjusted while the motor is running.

The system inertia and *parameter 7-08 Speed PID Feed Forward Factor* are used to calculate acceleration feed forward for the speed PID controller. Automatic measurement of system inertia and setting of this parameter are activated by setting the parameter to 0. System inertia is calculated after the 1<sup>st</sup> running cycle with sufficient data and the parameter is automatically set after stop. The function is only active when *parameter 1-01 Motor Control Principle* is set to [2] Flux Sensorless or [3] Flux w/motor feedb. Accelerate to at least model shift frequency (*parameter 1-53 Model Shift Frequency*) + 10 Hz and decelerate to produce a result. Measurement is possible in both speed, position, or synchronization mode.

## 5.2.8 1-7\* Start Adjustments

## Parameter 1-70 Start Mode

Table 121: Parameter 1-70 Start Mode

| 1-70 Start Mode                    |                        |                               |
|------------------------------------|------------------------|-------------------------------|
| Default value: [0] Rotor detection | Parameter type: Option | Setup: All setups             |
| Conversion index: –                | Data type: Uint8       | Change during operation: True |

Select the start-up mode. This is done to initialize the VVC+ control core for previously free-running motor. Both selections estimate the speed and angle. Active for PM and SynRM motors in VVC+ only.

| Option | Name                  | Description  |
|--------|-----------------------|--|
| [0]*   | Rotor detection       | Estimates the electrical angle of the rotor and uses this as a starting point. Standard selection for automation applications.   |
| [1]    | Parking               | The parking function applies DC current across the stator winding and rotates the rotor to electrical 0 position (typically selected for HVAC applications). Parking current and time are configured in <i>parameter 2-06 Parking Current</i> and <i>parameter 2-07 Parking Time</i> . |
| [2]    | Rotor det. w/ parking | Combining rotor detection with the parking function.   |

## Parameter 1-71 Start Delay

Table 122: Parameter 1-71 Start Delay

| 1-71 Start Delay     |                                   |                               |
|----------------------|-----------------------------------|-------------------------------|
| Default value: 0 s   | Parameter type: Range, 0 - 25.5 s | Setup: All setups             |
| Conversion index: -1 | Data type: Uint8                  | Change during operation: True |

This parameter refers to the start function selected in *parameter 1-72 Start Function*. Enter the time delay required before commencing acceleration.

## Parameter 1-72 Start Function

Table 123: Parameter 1-72 Start Function

| 1-72 Start Function                 |                        |                               |
|-------------------------------------|------------------------|-------------------------------|
| Default value: [2] Coast/delay time | Parameter type: Option | Setup: All setups             |
| Conversion index: –                 | Data type: Uint8       | Change during operation: True |

Select the start function during start delay. This parameter is linked to *parameter 1-71 Start Delay*.

| Option | Name                 | Description  |
|--------|----------------------|--|
| [0]    | DC hold/delay time   | Energize the motor with a DC hold current ( <i>parameter 2-00 DC Hold Current</i> ) during the start delay time.   |
| [1]    | DC brake/delay time  | Energize the motor with a DC brake current ( <i>parameter 2-01 DC Brake Current</i> ) during the start delay time.   |
| [2]*   | Coast/delay time     | Motor coasted during the start delay time (inverter off).  |
| [3]    | Start speed cw       | Only possible with VVC+. Connect the function described in <i>parameter 1-74 Start Speed [RPM]</i> and <i>parameter 1-76 Start Current</i> in the start delay time. Regardless of the value applied by the reference signal, the output speed applies the setting of the start speed in <i>parameter 1-74 Start Speed [RPM]</i> or <i>parameter 1-75 Start Speed [Hz]</i> , and the output current corresponds to the setting of the start current in <i>parameter 1-76 Start Current</i> . This function is typically used in hoisting applications without counterweight and especially in applications with a cone-motor where the start is clockwise, followed by rotation in the reference direction. |
| [4]    | Horizontal operation | Only possible with VVC+. For obtaining the function described in <i>parameter 1-74 Start Speed [RPM]</i> and <i>parameter 1-76 Start Current</i> during the start delay time. The motor rotates in the reference direction. If the reference signal equals 0, <i>parameter 1-74 Start Speed [RPM]</i> is ignored and the output speed equals 0. The output current corresponds to the setting of the start current in <i>parameter 1-76 Start Current</i> .  |
| [5]    | VVC+/flux clockwise  | For the function described in <i>parameter 1-74 Start Speed [RPM]</i> only. The start current is calculated automatically. This function uses the start speed in the start delay time only. Regardless of the value set by the reference signal, the output speed equals the setting of the start speed in <i>parameter 1-74 Start Speed [RPM]</i> . [3] Start speed/current clockwise and [5] VVC+/Flux clockwise are typically used in hoisting applica-   |



| Option | Name                  | Description  |
|--------|-----------------------|--|
|        |                       | tions. [4] Start speed/current in reference direction is particularly used in applications with counterweight and horizontal movement.   |
| [6]    | Hoist mech. brake rel | For utilizing mechanical brake control functions ( <i>parameter 2-24 Stop Delay</i> to <i>parameter 2-28 Gain Boost Factor</i> ). This parameter is only active in flux control principle, in a mode with motor feedback or sensorless mode. |
| [7]    | VVC+/flux counter-cw  | Same function as in [5] VVC+/flux clockwise but running in the opposite direction.   |

**Flying start function**

When flying start is enabled, *parameter 1-71 Start Delay* and *parameter 1-72 Start Function* have no function. When options [1] Enable and [2] Enabled always are enabled, *parameter 1-58 Flying Start Test Pulses Current* and *parameter 1-59 Flying Start Test Pulses Frequency* are used to specify conditions for flying start. For flying start version 1, options [3] Enabled ref. dir. and [4] Enab. always ref. dir. are set to search for the motor in the reference direction only, which allows a faster execution of the motor catch. For flying start version 2, options [11] to [14] are specific to asynchronous motor (induction motor) in VVC+ up to 132 Hz output frequency. These options provide a faster, more reliable, and robust flying start. When *parameter 1-73 Flying Start* is enabled, *parameter 1-71 Start Delay* has no function.

**Parameter 1-73 Flying Start**

Table 124: Parameter 1-73 Flying Start

| 1-73 Flying Start           |                        |                                |
|-----------------------------|------------------------|--------------------------------|
| Default value: [0] Disabled | Parameter type: Option | Setup: All setups              |
| Conversion index: –         | Data type: Uint8       | Change during operation: False |

**NOTICE**

This function is not recommended for hoisting applications. For power levels above 55 kW, flux mode must be used to achieve the best performance.

**NOTICE**

To obtain the best flying start performance, the advanced motor data, *parameter 1-30 Stator Resistance (Rs)* to *parameter 1-35 Main Reactance (Xh)*, must be correct.

This function makes it possible to catch a freely spinning motor, for example coasted because of mains dropout. When *parameter 1-73 Flying Start* is enabled, *parameter 1-71 Start Delay* has no function. Search direction for flying start is linked to the setting in *parameter 4-10 Motor Speed Direction*. [0] Clockwise: Flying start searches in clockwise direction. If not successful, a DC brake is carried out. [2] Both Directions: The flying start first searches in the direction determined by the last reference (direction). If the speed is not found, flying start searches in the other direction. If not successful, a DC brake activates in the time set in *parameter 2-02 DC Braking Time*. Start then takes place from 0 Hz.

| Option | Name                   | Description  |
|--------|------------------------|--|
| [0]*   | Disabled               | No function.   |
| [1]    | Enabled                | Enable after coast.  |
| [2]    | Enabled always         | Enable at every start.                                     |
| [3]    | Enabled ref. dir.      | Enable after coast, search in reference direction only.    |
| [4]    | Enab. always ref. dir. | Enable at every start, search in reference direction only. |
| [11]   | v2 Enabled             | Enable flying start version 2, after coast.                |

| Option | Name                    | Description   |
|--------|-------------------------|---|
| [12]   | v2 Enabled Always       | Enable flying start version 2, at every start.  |
| [13]   | v2 Enabled Ref. Dir.    | Enable flying start version 2, after coast, search in reference direction only.       |
| [14]   | v2 Enab. Alw. Ref. Dir. | Enable flying start version 2, ok at every start, search in reference direction only. |

### Parameter 1-74 Start Speed [RPM]

Table 125: Parameter 1-74 Start Speed [RPM]

| 1-74 Start Speed [RPM]      |                                    |                               |
|-----------------------------|------------------------------------|-------------------------------|
| Default value: Size related | Parameter type: Range, 0 - 600 RPM | Setup: All setups             |
| Conversion index: 67        | Data type: Uint16                  | Change during operation: True |

Set a motor start speed. After the start signal, the output speed leaps to set value. Set the start function in *parameter 1-72 Start Function* to [3] Start speed cw, [4] Horizontal operation, or [5] VVC+ /Flux clockwise, and set a start delay time in *parameter 1-71 Start Delay*.

### Parameter 1-75 Start Speed [Hz]

Table 126: Parameter 1-75 Start Speed [HZ]

| 1-75 Start Speed [HZ]       |                                     |                               |
|-----------------------------|-------------------------------------|-------------------------------|
| Default value: Size related | Parameter type: Range, 0 - 500.0 Hz | Setup: All setups             |
| Conversion index: -1        | Data type: Uint16                   | Change during operation: True |

This parameter can be used for hoist applications (cone rotor). Set a motor start speed. After the start signal, the output speed leaps to the set value. Set the start function in *parameter 1-72 Start Function* to [3] Start speed cw, [4] Horizontal operation, or [5] VVC+ /Flux clockwise, and set a start delay time in *parameter 1-71 Start Delay*.

### Parameter 1-76 Start Current

Table 127: Parameter 1-76 Start Current

| 1-76 Start Current   |  |                               |
|----------------------|--|-------------------------------|
| Default value: 0 A   | Parameter type: Range, 0 - par. 1-24 A | Setup: All setups             |
| Conversion index: -2 | Data type: Uint32                      | Change during operation: True |

Some motors, for example cone rotor motors, need extra current/starting speed to disengage the rotor. To obtain this boost, set the required current in *parameter 1-76 Start Current*. Set *parameter 1-74 Start Speed [RPM]*. Set *parameter 1-72 Start Function* to [3] Start speed cw or [4] Horizontal operation, and set a start delay time in *parameter 1-71 Start Delay*. This parameter can be used for hoist applications (cone rotor).

## 5.2.9 1-8\* Stop Adjustments

### Parameter 1-80 Function at Stop

Table 128: Parameter 1-80 Function at Stop

| 1-80 Function at Stop    |                        |                               |
|--------------------------|------------------------|-------------------------------|
| Default value: [0] Coast | Parameter type: Option | Setup: All setups             |
| Conversion index: -      | Data type: Uint8       | Change during operation: True |

Select the drive function after a stop command or after the speed is ramped down to the settings in *parameter 1-81 Min Speed for Function at Stop [RPM]*.

Table 129: Choices Depending on Control

|         |          | ASM                     | SPM             | IPM             | SynRM       |
|---------|----------|-------------------------|-----------------|-----------------|-------------|
| VVC+    | Speed OL | All choices             | [0],[1],[5]     | [0],[1],[5]     | [0],[1],[5] |
| Flux OL | Speed OL | [0],[1],[2],[3],[5],[6] | [0],[1],[5]     | [0],[1],[5]     | -           |
| Flux CL | Speed CL | All choices             | [0],[1],[5],[8] | [0],[1],[5],[8] | -           |

| Op-tion | Name                   | Description  |
|---------|------------------------|--|
| [0]*    | Coast                  | Leaves motor in free mode. The motor is disconnected from the drive.   |
| [1]     | DC hold                | Energizes the motor with a DC hold current (see <i>parameter 2-00 DC Hold Current</i> ).   |
| [2]     | Motor check            | Checks if a motor has been connected. The interval for checking the motor can be defined in <i>parameter 4-49 Motor Check Time Interval</i> .  |
| [3]     | Premagnetizing         | <p>Builds up a magnetic field while the motor is stopped. This allows the motor to produce torque quickly at subsequent start commands (asynchronous motors only). This premagnetizing function does not help the 1<sup>st</sup> start command. Two different solutions are available to premagnetize the machine for the 1<sup>st</sup> start command:</p> <ul style="list-style-type: none"> <li>Start the drive with a 0 RPM reference and wait 2–4 rotor time constants before increasing the speed reference.</li> <li>Use the start delay with DC hold:</li> </ul> <p>Set <i>parameter 1-71 Start Delay</i> to the required premagnetizing time (2–4 rotor time constants). See the time constants description further in this section. Set <i>parameter 1-72 Start Function</i> to either [0] DC hold or [1] DC Brake. Set the DC hold or DC brake current magnitude (<i>parameter 2-00 DC Hold Current</i> or <i>parameter 2-01 DC Brake Current</i>) to be equal to <math>I_{pre-mag} = U_{nom} / (1.73 \times X_h)</math>.</p> <p>Sample rotor time constants = <math>(X_h + X_2) / (6.3 \times Freq_{nom} \times R_r)</math></p> <ul style="list-style-type: none"> <li>1 kW = 0.2 s</li> <li>10 kW = 0.5 s</li> <li>100 kW = 1.7 s</li> <li>1000 kW = 2.5 s</li> </ul> |
| [4]     | DC voltage U0          | When the motor is stopped, <i>parameter 1-55 U/f Characteristic - U [0]</i> defines the voltage at 0 Hz.   |
| [5]     | Coast at low reference | When the reference is below <i>parameter 1-81 Min Speed for Function at Stop [RPM]</i> , the drive coasts the motor.   |
| [6]     | Motor check, alarm     | The drive issues an alarm if 1 or more motor phases are missing.   |
| [8]     | Torque ramp to zero    | <div style="text-align: center; background-color: #cccccc; padding: 5px;"><b>NOTICE</b></div> <p>This option is only available in FC 302.</p> <p>When the motor reaches the speed defined in <i>parameter 1-81 Min Speed for Function at Stop [RPM]</i>, the drive ramps the torque down to 0 torque (for example, for extruder applications where a high torque is present at low speed). The torque ramp time can be set in <i>parameter 1-89 Stop Func Torque Ramp Time</i>.</p>  |

Parameter 1-81 Min Speed for Function at Stop [RPM]

Table 130: Parameter 1-81 Min Speed for Function at Stop [RPM]

| 1-81 Min Speed for Function at Stop [RPM] |                                    |                               |
|---|------------------------------------|-------------------------------|
| Default value: Size related               | Parameter type: Range, 0 - 600 RPM | Setup: All setups             |
| Conversion index: 67                      | Data type: Uint16                  | Change during operation: True |

Set the speed at which to activate *parameter 1-80 Function at Stop*.

Parameter 1-82 Min Speed for Function at Stop [Hz]

Table 131: Parameter 1-82 Min Speed for Function at Stop [Hz]

| 1-82 Min Speed for Function at Stop [Hz] |                                     |                               |
|--|-------------------------------------|-------------------------------|
| Default value: Size related              | Parameter type: Range, 0 - 500.0 Hz | Setup: All setups             |
| Conversion index: -1                     | Data type: Uint16                   | Change during operation: True |

Set the output frequency at which to activate *parameter 1-80 Function at Stop*.

Parameter 1-83 Precise Stop Function

Table 132: Parameter 1-83 Precise Stop Function

| 1-83 Precise Stop Function           |                        |                                |
|--------------------------------------|------------------------|--------------------------------|
| Default value: [0] Precise ramp stop | Parameter type: Option | Setup: All setups              |
| Conversion index: -                  | Data type: Uint8       | Change during operation: False |

N O T I C E

This is valid for FC 302 only.

N O T I C E

This parameter cannot be adjusted while the motor is running.

| Op-tion | Name                | Description   |
|---------|---------------------|---|
| [0]*    | Precise ramp stop   | Only optimal when the operational speed, for example, the operational speed of a conveyor belt, is constant. This is an open-loop control. Achieves high repetitive precision at the stop point.  |
| [1]     | Cnt stop with reset | Counts the number of pulses, typically from an encoder, and generates a stop signal after a preprogrammed number of pulses, defined in <i>parameter 1-84 Precise Stop Counter Value</i> , has been received at terminal 29 or terminal 33. This is direct feedback with one-way closed-loop control. The counter function is activated (starts timing) at the edge of the start signal (when it changes from stop to start). After each precise stop, the number of pulses counted during ramp-down to 0 RPM are reset. |
| [2]     | Cnt stop w/o reset  | Same as [2] <i>Cnt stop with reset</i> but the number of pulses counted during ramp down to 0 RPM are deducted from the counter value entered in <i>parameter 1-84 Precise Stop Counter Value</i> . This reset function can be used to compensate for the extra distance done during ramping down and to reduce the impacts of gradual wear of mechanical parts.  |
| [3]     | Speed comp stop     | Stops at precisely the same point, regardless of the present speed. The stop signal is delayed internally when the present speed is lower than the maximum speed (set in <i>parameter 4-19 Max Output Frequency</i> ).  |

| Option | Name                | Description   |
|--------|---------------------|---|
|        |                     | The delay is calculated on the basis of the reference speed of the drive and not on the basis of the actual speed. Make sure that the drive has ramped up before activating the speed-compensated stop.   |
| [4]    | Com cnt stop w/rst  | Same as [3] <i>Speed comp stop</i> but after each precise stop, the number of pulses counted during ramp down to 0 RPM is reset.  |
| [5]    | Comp cnt stop w/o r | Same as [3] <i>Speed comp stop</i> but the number of pulses counted during ramp down to 0 RPM is deducted from the counter value entered in <i>parameter 1-84 Precise Stop Counter Value</i> . This reset function can be used to compensate for the extra distance done during ramping down and to reduce the impacts of gradual wear of mechanical parts. |

The precise stop functions are advantageous in applications where high precision is required. If using a standard stop command, the accuracy is determined by the internal task time. That is not the case when using the precise stop function. It eliminates the task time dependence and increases the accuracy substantially. The drive tolerance is normally given by its task time. However, by using its special precise stop function, the tolerance is independent of the task time because the stop signal immediately interrupts the execution of the drive program. The precise stop function gives a highly reproducible delay from the stop signal is given until the ramping down starts. Run a test to find this delay as it is a sum of sensor, PLC, drive, and mechanical parts.

To ensure optimum accuracy, there should be at least 10 cycles during ramping down, see:

- *Parameter 3-42 Ramp 1 Ramp Down Time*
- *Parameter 3-52 Ramp 2 Ramp Down Time*
- *Parameter 3-62 Ramp 3 Ramp Down Time*
- *Parameter 3-72 Ramp 4 Ramp Down Time*

The precise stop function is set up here and enabled from DI at terminal 29 or terminal 33.

**Parameter 1-84 Precise Stop Counter Value**

**Table 133: Parameter 1-84 Precise Stop Counter Value**

| 1-84 Precise Stop Counter Value |                                      |                               |
|---------------------------------|--------------------------------------|-------------------------------|
| Default value: 100000           | Parameter type: Range, 0 - 999999999 | Setup: All setups             |
| Conversion index: 0             | Data type: Uint32                    | Change during operation: True |

Enter the counter value to be used in the integrated precise stop function, *parameter 1-83 Precise Stop Function*. The maximum permissible frequency at terminal 29 or 33 is 110 kHz.

**NOTICE**

Not used for selections [0] *Precise ramp stop* and [3] *Speed comp stop* in *parameter 1-83 Precise Stop Function*.

**Parameter 1-85 Precise Stop Speed Compensation Delay**

**Table 134: Parameter 1-85 Precise Stop Speed Compensation Delay**

| 1-85 Precise Stop Speed Compensation Delay |                                   |                               |
|--|-----------------------------------|-------------------------------|
| Default value: 10 ms                       | Parameter type: Range, 0 - 100 ms | Setup: All setups             |
| Conversion index: -3                       | Data type: Uint8                  | Change during operation: True |

Enter the delay time for sensors, PLCs, and so on for use in *parameter 1-83 Precise Stop Function*. In speed-compensated stop mode, the delay time at different frequencies has a major influence on the stop function.

**NOTICE**

Not used for selections [0] *Precise ramp stop*, [1] *Cnt stop with reset*, and [2] *Cnt stop w/o reset* in *parameter 1-83 Precise Stop Function*.

Parameter 1-89 Stop Func Torque Ramp Time

Table 135: Parameter 1-89 Stop Func Torque Ramp Time

| 1-89 Stop Func Torque Ramp Time |   |                               |
|---------------------------------|---|-------------------------------|
| Default value: 0.01 s           | Parameter type: Range, 0.01 - 3600.00 s | Setup: All setups             |
| Conversion index: -2            | Data type: Uint32                       | Change during operation: True |

Configure the time in seconds during which the torque is ramped to 0, after the motor speed is ramped down to the minimum speed as specified in *parameter 1-81 Min Speed for Function at Stop [RPM]*.

5.2.10 1-9\* Motor Temperature

**NOTICE**

The following parameters are only available in FC 302:

- *Parameter 1-94 ATEX ETR Cur.Lim. Speed Reduction*
- *Parameter 1-95 Thermistor Sensor Type*
- *Parameter 1-96 Thermistor Sensor Resource*
- *Parameter 1-98 ATEX ETR Interpol. Points Freq.*
- *Parameter 1-99 ATEX ETR Interpol. Points Current*

Parameter 1-90 Motor Thermal Protection

Table 136: Parameter 1-90 Motor Thermal Protection

| 1-90 Motor Thermal Protection    |                        |                               |
|----------------------------------|------------------------|-------------------------------|
| Default value: [0] No protection | Parameter type: Option | Setup: All setups             |
| Conversion index: -              | Data type: Uint8       | Change during operation: True |

Motor thermal protection can be implemented using a range of techniques:

- Via a PTC sensor in the motor windings connected to 1 of the analog or digital inputs (*parameter 1-93 Thermistor Resource*). See the *chapter PTC Thermistor Connection*.
- Via a KTY sensor in the motor winding connected to an analog input (*parameter 1-96 Thermistor Sensor Resource*). See the *chapter KTY Sensor Connection*.
- Via calculation (ETR = Electronic Thermal Relay) of the thermal load, based on the actual load and time. The calculated thermal load is compared with the rated motor current  $I_{M,N}$  and the rated motor frequency  $f_{M,N}$ . See the *chapter ETR*.
- Via a mechanical thermal switch (Klixon type). See the *chapter Klixon*.

For the North American market: The ETR functions provide class 20 motor overload protection in accordance with NEC.

| Option | Name               | Description   |
|--------|--------------------|---|
| [0]*   | No protection      | Continuously overloaded motor when no warning or trip of the drive is required.   |
| [1]    | Thermistor warning | Activates a warning when the connected thermistor or KTY sensor in the motor reacts in the event of motor overtemperature.  |
| [2]    | Thermistor trip    | Stops (trips) the drive when connected thermistor or KTY sensor in the motor reacts in the event of motor overtemperature. The thermistor cutout value must be more than 3 kΩ. Integrate a thermistor (PTC sensor) in the motor for winding protection. |
| [3]    | ETR warning 1      | Calculates the load when setup 1 is active and activates a warning on the display when the motor is overloaded. Program a warning signal via 1 of the digital outputs.  |

| Option | Name          | Description  |
|--------|---------------|--|
| [4]    | ETR trip 1    | Calculates the load when set-up 1 is active and stops (trips) the drive when the motor is overloaded. Program a warning signal via 1 of the digital outputs. The signal appears in the event of a warning and if the drive trips (thermal warning).        |
| [5]    | ETR warning 2 |  |
| [6]    | ETR trip 2    |  |
| [7]    | ETR warning 3 |  |
| [8]    | ETR trip 3    |  |
| [9]    | ETR warning 4 |  |
| [10]   | ETR trip 4    |  |
| [20]   | ATEX ETR      | Activates the thermal monitoring function for Ex-e motors for ATEX. Enables <i>parameter 1-94 ATEX ETR cur.lim. speed reduction</i> , <i>parameter 1-98 ATEX ETR interpol. points freq.</i> , and <i>parameter 1-99 ATEX ETR interpol points current</i> . |
| [21]   | Advanced ETR  |  |

**NOTICE**

If [20] ATEX ETR is selected, follow the instructions in the dedicated chapter of the design guide and the instructions provided by the motor manufacturer.

**NOTICE**

If [20] ATEX ETR is selected, set *parameter 4-18 Current Limit* to 150%.

Parameter 1-91 Motor External Fan

Table 137: Parameter 1-91 Motor External Fan

| 1-91 Motor External Fan     |                        |                               |
|-----------------------------|------------------------|-------------------------------|
| Default value: Size related | Parameter type: Option | Setup: All setups             |
| Conversion index: -         | Data type: Uint8       | Change during operation: True |

| Option | Name | Description   |
|--------|------|---|
| [0]    | No   | No external fan is required, that is the motor is derated at low speed.   |
| [1]    | Yes  | Applies an external motor fan (external ventilation), so no derating of the motor is required at low speed. The upper curve in <a href="#">Illustration 43</a> ( $f_{out} = 1 \times f_{M,N}$ ) is followed if the motor current is lower than nominal motor current (see <i>parameter 1-24 Motor Current</i> ). If the motor current exceeds nominal current, the operation time still decreases as if no fan was installed. |

Parameter 1-93 Thermistor Resource

Table 138: Parameter 1-93 Thermistor Resource

| 1-93 Thermistor Resource |                        |                               |
|--------------------------|------------------------|-------------------------------|
| Default value: [0] None  | Parameter type: Option | Setup: All setups             |
| Conversion index: -      | Data type: Uint8       | Change during operation: True |

### N O T I C E

This parameter cannot be adjusted while the motor is running.

### N O T I C E

Set digital input to [0] PNP - Active at 24 V in parameter 5-00 Digital I/O Mode.

### N O T I C E

When using VLT® PTC Thermistor Card MCB 112 always always select [0] None.

Select the input to which the thermistor (PTC sensor) should be connected. An analog input option [1] Analog Input 53 or [2] Analog Input 54 cannot be selected if the analog input is already in use as a reference source (selected in parameter 3-15 Reference Resource 1, parameter 3-16 Reference Resource 2, or parameter 3-17 Reference Resource 3).

| Option | Name             | Description |
|--------|------------------|-------------|
| [0]*   | None             |             |
| [1]    | Analog input 53  |             |
| [2]    | Analog input 54  |             |
| [3]    | Digital input 18 |             |
| [4]    | Digital input 19 |             |
| [5]    | Digital input 32 |             |
| [6]    | Digital input 33 |             |

#### Parameter 1-94 ATEX ETR Cur. Lim. Speed Reduction

Table 139: Parameter 1-94 ATEX ETR Cur. Lim. Speed Reduction

| 1-94 ATEX ETR Cur. Lim. Speed Reduction |                                 |                               |
|---|---------------------------------|-------------------------------|
| Default value: 0%                       | Parameter type: Range, 0 - 100% | Setup: 2 setups               |
| Conversion index: -1                    | Data type: Uint16               | Change during operation: True |

Only visible if parameter 1-90 Motor Thermal Protection is set to [20] ATEX ETR.

Configure the reaction for operating in Ex-e current limit. 0%: The drive does not change anything besides issuing warning 163, ATEX ETR cur.lim.warning. >0%: The drive issues warning 163, ATEX ETR cur.lim.warning and reduces motor speed following ramp 2 (parameter group 3-5\* Ramp 2).

#### Example:

Actual reference = 50 RPM

Parameter 1-94 ATEX ETR cur.lim. speed reduction = 20%

Resulting reference = 40 RPM

#### Parameter 1-95 Thermistor Sensor Type

Table 140: Parameter 1-95 Thermistor Sensor Type

| 1-95 Thermistor Sensor Type     |                        |                               |
|---------------------------------|------------------------|-------------------------------|
| Default value: [0] KTY Sensor 1 | Parameter type: Option | Setup: All setups             |
| Conversion index: -             | Data type: Uint8       | Change during operation: True |

Select the used type of thermistor sensor.



| Option | Name                | Description   |
|--------|---------------------|---|
| [0]*   | KTY sensor 1        | 1 kΩ at 100 °C (212 °F).  |
| [1]    | KTY sensor 2        | 1 kΩ at 25 °C (77 °F).  |
| [2]    | KTY sensor 3        | 2 kΩ at 25 °C (77 °F).  |
| [3]    | Pt1000              | 1 kΩ at 0 °C (32 °F).   |
| [4]    | Ni1000 (6178 ppm/K) | 1 kΩ at 0 °C (32 °F).   |
| [5]    | Ni1000-LG (TC5)     | Examples: <ul style="list-style-type: none"> <li>Siemens LG-Ni1000</li> <li>Tasseron RTD Ni1000-TC5 1000 Ohm</li> </ul> |

## Parameter 1-96 Thermistor Sensor Resource

Table 141: Parameter 1-96 Thermistor Sensor Resource

| 1-96 Thermistor Sensor Resource |                        |                               |
|---------------------------------|------------------------|-------------------------------|
| Default value: [0] None         | Parameter type: Option | Setup: All setups             |
| Conversion index: –             | Data type: Uint8       | Change during operation: True |

Select analog input terminal 54 to be used for connection of KTY/Pt1000/Ni1000 thermistor sensor. Terminal 54 cannot be selected as thermistor source if otherwise used as reference (see *parameter 3-15 Reference Resource 1* to *parameter 3-17 Reference Resource 3*).

## N O T I C E

Connection of thermistor sensor between terminals 54 and 55 (GND).

| Option | Name            | Description |
|--------|-----------------|-------------|
| [0]*   | None            |             |
| [2]    | Analog input 54 |             |

## Parameter 1-97 Thermistor Threshold Level

Table 142: Parameter 1-97 Thermistor Threshold Level

| 1-97 Thermistor Threshold Level |                                     |                               |
|---------------------------------|-------------------------------------|-------------------------------|
| Default value: 80 °C            | Parameter type: Range, -40 - 220 °C | Setup: 1 setup                |
| Conversion index: 100           | Data type: Int16                    | Change during operation: True |

Select the thermistor sensor threshold level for motor thermal protection.

## Parameter 1-98 ATEX ETR Interpol. Points Freq.

Table 143: Parameter 1-98 ATEX ETR Interpol. Points Freq.

| 1-98 ATEX ETR Interpol. Points Freq. |   |                               |
|--------------------------------------|---|-------------------------------|
| Default value: Size related          | Parameter type: Range, 0 - 1000.0 Hz, Array [4] | Setup: 1 setup                |
| Conversion index: -1                 | Data type: Uint16                               | Change during operation: True |

Only visible if *parameter 1-90 Motor Thermal Protection* is set to [20] ATEX ETR.

Enter the 4 frequency points [Hz] from the motor nameplate into this array.

**N O T I C E**

- All frequency/current limit points from the motor nameplate or motor datasheet must be programmed.

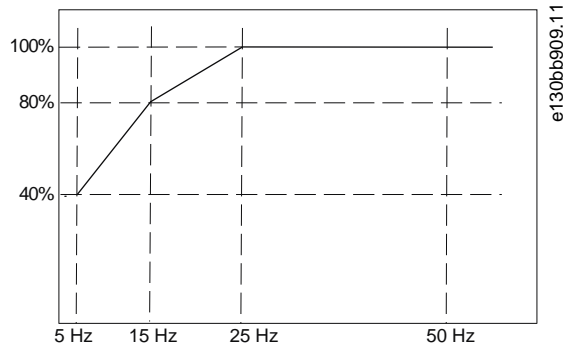

Illustration 38: Example of ATEX ETR Thermal Limitation Curve

x-axis:  $f_m$  [Hz]

y-axis:  $I_m/I_{m,n} \times 100$  [%]

Table 144: Interpolation Points

| Parameter 1-98 ATEX ETR interpol. points freq. | Parameter 1-99 ATEX ETR interpol. points current |
|--|--|
| [0]=5 Hz                                       | [0]=40%  |
| [1]=15 Hz                                      | [1]=80%  |
| [2]=25 Hz                                      | [2]=100%   |
| [3]=50 Hz                                      | [3]=100%   |

All operating points underneath the curve are allowed continuously. Above the line, however, these are only allowed for a limited time calculated as a function of the overload. When machine current is greater than 1.5 times the rated current, shutdown is immediate.

Parameter 1-99 ATEX ETR Interpol. Points Current

Table 145: Parameter 1-99 ATEX ETR Interpol. Points Current

| 1-99 ATEX ETR Interpol. Points Current |  |                               |
|--|--|-------------------------------|
| Default value: Size related            | Parameter type: Range, 0 - 100%, Array [4] | Setup: 2 setups               |
| Conversion index: 0                    | Data type: Uint16                          | Change during operation: True |

Definition of the thermal limitation curve. For example, see *parameter 1-98 ATEX ETR Interpol. Points Freq.*

Use the 4 current points [A] from the motor nameplate. Calculate the values as percentage of nominal motor current,  $I_m/I_{m,n} \times 100$  [%], and enter the values into this array.

Together with *parameter 1-98 ATEX ETR Interpol. Points Freq.*, these constitute a table (f [Hz], I [%]).

**N O T I C E**

All frequency/current limit points from the motor nameplate or motor datasheet must be programmed.

### 5.2.10.1 PTC Thermistor Connection

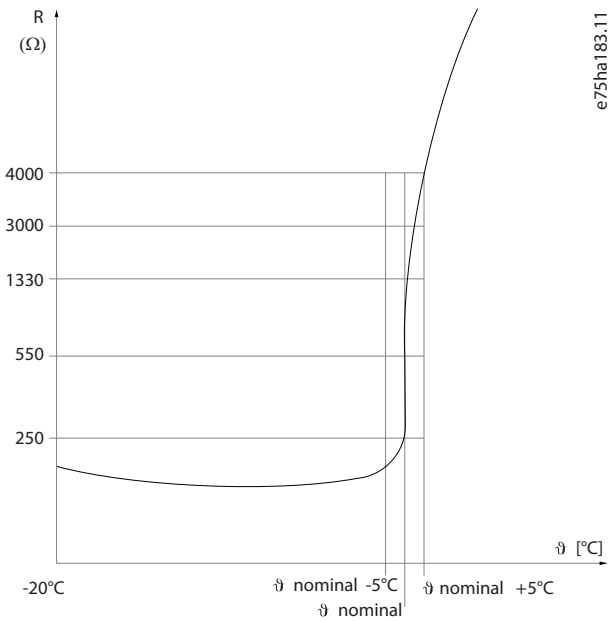

e/75ha183.11

Illustration 39: PTC Profile

Using a digital input and 10 V as supply: Example: The drive trips when the motor temperature is too high.

Parameter setup:

- Set parameter 1-90 Motor Thermal Protection to [2] Thermistor Trip.
- Set parameter 1-93 Thermistor Source to [6] Digital Input.

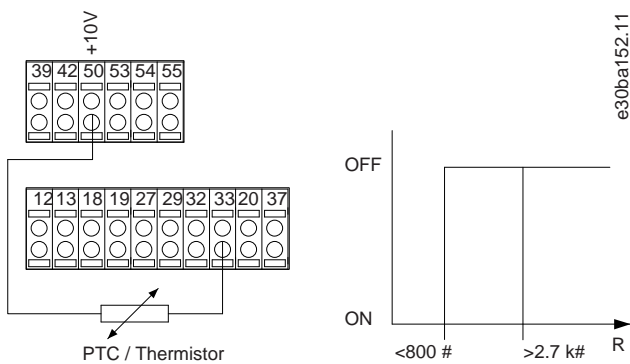

e/30bat152.11

Illustration 40: PTC Thermistor Connection - Digital Input

Using an analog input and 10 V as supply: Example: The drive trips when the motor temperature is too high.

Parameter setup:

- Set parameter 1-90 Motor Thermal Protection to [2] Thermistor Trip.
- Set parameter 1-93 Thermistor Source to [2] Analog Input 54.

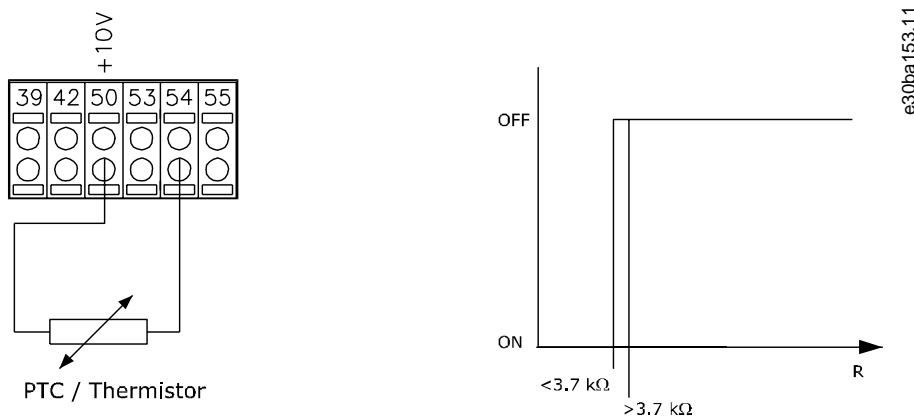

Illustration 41: PTC Thermistor Connection - Analog Input

Table 146: Threshold Cutout Values

| Input digital/analog | Supply voltage | Threshold cutout values |
|----------------------|----------------|-------------------------|
| Digital              | 10 V           | <800 Ω ⇒ 2.7 kΩ         |
| Analog               | 10 V           | <3.0 kΩ ⇒ 3.0 kΩ        |

**NOTICE**

Check that the selected supply voltage follows the specification of the used thermistor element.

### 5.2.10.2 KTY Sensor Connection

**NOTICE**

KTY sensor connection is only available in FC 302.

KTY sensors are used especially in permanent magnet servo motors (PM motors) for dynamic adjusting of motor parameters as stator resistance (*parameter 1-30 Stator Resistance (Rs)*) for PM motors and also rotor resistance (*parameter 1-31 Rotor Resistance (Rr)*) for asynchronous motors, depending on winding temperature. The calculation is:

$$R_s = R_{s_{20^{\circ}C}} \times (1 + \alpha_{Cu} \times \Delta T) \Omega \text{ where } \alpha_{Cu} = 0.00393$$

KTY sensors can be used for motor protection (*parameter 1-97 KTY Threshold level*). FC 301 can handle 3 types of KTY sensors, defined in *parameter 1-95 KTY Sensor Type*. The actual sensor temperature can be read out from *parameter 16-19 KTY sensor temperature*.

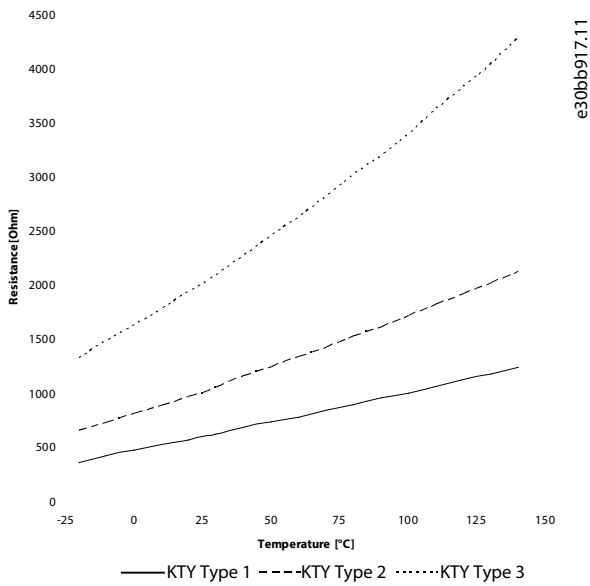

Illustration 42: KTY Type Selection

- KTY Sensor 1: 1 kΩ at 100 °C (212 °F) (for example Philips KTY 84-1)
- KTY Sensor 2: 1 kΩ at 25 °C (77 °F) (for example Philips KTY 83-1)
- KTY Sensor 3: 2 kΩ at 25 °C (77 °F) (for example Infineon KTY-10)

**NOTICE**

If the temperature of the motor is utilized through a thermistor or KTY sensor, the PELV is not complied with if there are short circuits between motor windings and the sensor. Put extra isolation on the sensor to comply with PELV.

5.2.10.3 ETR

The calculations estimate the need for a lower load at lower speed due to less cooling from the fan incorporated in the motor.

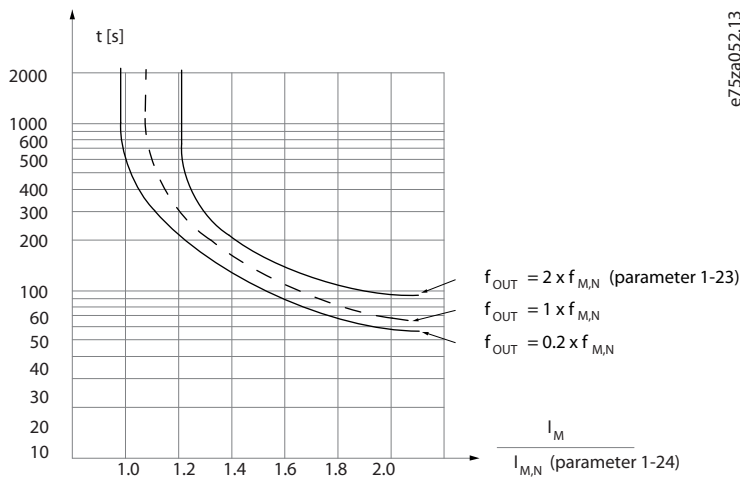

Illustration 43: ETR Profile

5.2.10.4 ATEX ETR

The VLT® PTC Thermistor Card MCB 112 offers ATEX-approved monitoring of motor temperature. Alternatively, an external ATEX-approved PTC protection device can be used.

## N O T I C E

Only use ATEX Ex-e-approved motors for this function. See motor nameplate, approval certificate, datasheet, or contact motor supplier.

When controlling an Ex-e motor with increased safety, it is important to ensure certain limitations. The parameters that must be programmed are presented in the following table.

**Table 147: Parameters**

| Function  | Setting   |
|---|---|
| <i>Parameter 1-90 Motor Thermal Protection</i>          | [20] ATEX ETR   |
| <i>Parameter 1-94 ATEX ETR cur.lim. speed reduction</i> | 20%   |
| <i>Parameter 1-98 ATEX ETR interpol. points freq.</i>   | Motor nameplate.  |
| <i>Parameter 1-99 ATEX ETR interpol points current</i>  |   |
| <i>Parameter 1-23 Motor Frequency</i>                   | Enter the same value as for <i>parameter 4-19 Max Output Frequency</i> .  |
| <i>Parameter 4-19 Max Output Frequency</i>              | Motor nameplate, possibly reduced for long motor cables, sine-wave filter, or reduced supply voltage.           |
| <i>Parameter 4-18 Current Limit</i>                     | Forced to 150% by 1-90 [20]   |
| <i>Parameter 5-15 Terminal 33 Digital Input</i>         | [80] PTC Card 1   |
| <i>Parameter 5-19 Terminal 37 Safe Stop</i>             | [4] PTC 1 Alarm   |
| <i>Parameter 14-01 Switching Frequency</i>              | Check that the default value fulfills the requirement from the motor nameplate. If not, use a sine-wave filter. |
| <i>Parameter 14-26 Trip Delay at Inverter Fault</i>     | 0   |

## N O T I C E

Compare the minimum switching frequency requirement stated by the motor manufacturer to the minimum switching frequency of the drive, the default value in *parameter 14-01 Switching Frequency*. If the drive does not meet this requirement, use a sine-wave filter.

More information about ATEX ETR thermal monitoring can be found in Application Note for FC 300 ATEX ETR Thermal Monitoring Function.

### 5.2.10.5 Klixon

The Klixon type thermal circuit breaker uses a KLIXON® metal dish. At a predetermined overload, the heat caused by the current through the disc causes a trip.

Using a digital input and 24 V as supply:

Example: The drive trips when the motor temperature is too high.

Parameter setup:

- Set *parameter 1-90 Motor Thermal Protection* to [2] *Thermistor Trip*.
- Set *parameter 1-93 Thermistor Source* to [6] *Digital Input*.

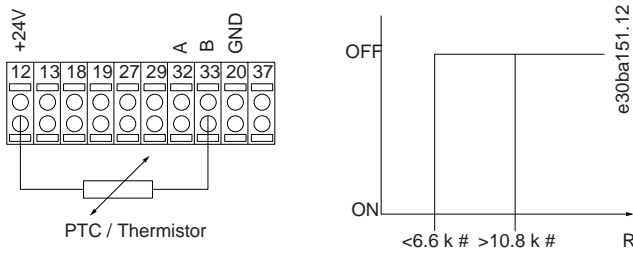

Illustration 44: Thermistor Connection

### 5.2.10.6 PM Settings

If [2] Std. PM, non-salient is selected in parameter 1-10 Motor Construction, enter the motor parameters manually in the following order:

- Parameter 1-24 Motor Current.
- Parameter 1-26 Motor Cont. Rated Torque.
- Parameter 1-25 Motor Nominal Speed.
- Parameter 1-39 Motor Poles.
- Parameter 1-30 Stator Resistance (Rs).
- Parameter 1-37 d-axis Inductance (Ld).
- Parameter 1-40 Back EMF at 1000 RPM.

The following parameters have been added for PM motors.

- Parameter 1-41 Motor Angle Offset.
- Parameter 1-07 Motor Angle Offset Adjust.
- Parameter 1-14 Damping Gain.
- Parameter 1-47 Torque Calibration.
- Parameter 1-58 Flying Start Test Pulses Current.
- Parameter 1-59 Flying Start Test Pulses Frequency.
- Parameter 1-70 Start Mode.
- Parameter 30-20 High Starting Torque Time [s].
- Parameter 30-21 High Starting Torque Current [%].

## NOTICE

Standard parameters still need configuration (for example parameter 4-19 Max Output Frequency).

Table 148: Recommendations for VVC<sup>+</sup> Applications

| Application   | Settings  |
|---|---|
| Low inertia applications<br>$I_{Load}/I_{Motor} < 5$      | Increase parameter 1-17 Voltage Filter Time Const. by factor 5–10.<br>Reduce parameter 1-14 Damping Gain.<br>Reduce parameter 1-66 Min. Current at Low Speed (<100%). |
| Low inertia applications<br>$50 > I_{Load}/I_{Motor} > 5$ | Keep calculated values.   |
| High inertia applications                                 | Increase parameter 1-14 Damping Gain, parameter 1-15 Low Speed Filter Time Const., and parameter 1-16 High Speed Filter Time Const.                                   |

| Application                               | Settings   |
|---|--|
| $I_{Load}/I_{Motor} > 50$                 |  |
| High load at low speed <30% (rated speed) | Increase <i>parameter 1-17 Voltage filter time const.</i> Increase <i>parameter 1-66 Min. Current at Low Speed</i> (>100% for longer time can overheat the motor). |

If the motor starts oscillating at a certain speed, increase *parameter 1-14 Damping Gain*. Increase the value in small steps. Depending on the motor, a good value for this parameter can be 10% or 100% higher than the default value.

Adjust starting torque in *parameter 1-66 Min. Current at Low Speed*. 100% provides nominal torque as starting torque.

Table 149: Recommendations for Flux Applications

| Application               | Settings   |
|---------------------------|--|
| Low inertia applications  | Keep calculated values.  |
| High inertia applications | <i>Parameter 1-66 Min. Current at Low Speed</i> . Increase speed to a value between default and maximum depending on application. Set ramp times matching the application. Too fast ramp-up causes an overcurrent/overtorque. Too fast ramp-down causes an overvoltage trip. |
| High load at low speed    | <i>Parameter 1-66 Min. Current at Low Speed</i> . Increase speed to a value between default and maximum depending on application.  |

Adjust starting torque in *parameter 1-66 Min. Current at Low Speed*. 100% provides nominal torque as starting torque.

### 5.3 Parameter Group 2-\*\* Brakes

#### 5.3.1 2-0\* DC Brakes

Parameter group for configuring the DC brake and DC hold functions.

##### Parameter 2-00 DC Hold Current

Table 150: Parameter 2-00 DC Hold Current

| 2-00 DC Hold Current |                                 |                               |
|----------------------|---------------------------------|-------------------------------|
| Default value: 50%   | Parameter type: Range, 0 - 160% | Setup: All setups             |
| Conversion index: 0  | Data type: Uint8                | Change during operation: True |

### NOTICE

The maximum value depends on the rated motor current. Avoid 100% current for too long. It may damage the motor. In VVC+ control core, low values (<20%) of DC hold may result in wrong currents with larger motor sizes (>90 kW) and should be avoided. In cases when low DC hold currents with larger motors are required, select Flux control core to ensure the right currents.

Enter a value for holding current as a percentage of the rated motor current  $I_{M,N}$  set in *parameter 1-24 Motor Current*. 100% DC hold current corresponds to  $I_{M,N}$ . This parameter holds the motor function (holding torque) or preheats the motor. This parameter is active if DC hold is selected in *parameter 1-72 Start Function [0]* or *parameter 1-80 Function at Stop [1]*.

##### Parameter 2-01 DC Brake Current

Table 151: Parameter 2-01 DC Brake Current

| 2-01 DC Brake Current |                                  |                               |
|-----------------------|----------------------------------|-------------------------------|
| Default value: 50%    | Parameter type: Range, 0 - 1000% | Setup: All setups             |
| Conversion index: 0   | Data type: Uint16                | Change during operation: True |

### NOTICE

The maximum value depends on the rated motor current. Avoid 100% current for too long. It may damage the motor.



Enter a value for current as a percentage of the rated motor current  $I_{M,N}$ , see *parameter 1-24 Motor Current*. 100% DC brake current corresponds to  $I_{M,N}$ . DC brake current is applied on a stop command, when the speed is lower than the limit set in *parameter 2-03 DC Brake Cut In Speed [RPM]*; when the DC brake inverse function is active, or via the serial communication port. The braking current is active during the time period set in *parameter 2-02 DC Braking Time*.

Parameter 2-02 DC Braking Time

Table 152: Parameter 2-02 DC Braking Time

| 2-02 DC Braking Time |                                 |                               |
|----------------------|---------------------------------|-------------------------------|
| Default value: 10 s  | Parameter type: Range, 0 - 60 s | Setup: All setups             |
| Conversion index: -1 | Data type: Uint16               | Change during operation: True |

Set the duration of the DC brake current set in *parameter 2-01 DC Brake Current*, once activated.

Parameter 2-03 DC Brake Cut In Speed [RPM]

Table 153: Parameter 2-03 DC Brake Cut In Speed [RPM]

| 2-03 DC Brake Cut In Speed [RPM] |  |                               |
|----------------------------------|--|-------------------------------|
| Default value: Size related      | Parameter type: Range, 0 - par. 4-13 RPM | Setup: All setups             |
| Conversion index: 67             | Data type: Uint16                        | Change during operation: True |

Set the DC brake cut-in speed for activation of the DC brake current set in *parameter 2-01 DC Brake Current*, upon a stop command.

Parameter 2-04 DC Brake Cut In Speed [Hz]

Table 154: Parameter 2-04 DC Brake Cut In Speed [Hz]

| 2-04 DC Brake Cut In Speed [Hz] |  |                               |
|---------------------------------|--|-------------------------------|
| Default value: Size related     | Parameter type: Range, 0 - par. 4-14 RPM | Setup: All setups             |
| Conversion index: -1            | Data type: Uint16                        | Change during operation: True |

## NOTICE

*Parameter 2-04 DC Brake Cut In Speed [Hz]* is not effective when *parameter 1-10 Motor Construction* = [1] PM, nonsalient SPM.

Set the DC brake cut-in speed for activation of the DC brake current set in *parameter 2-01 DC Brake Current*, upon a stop command.

Parameter 2-05 Maximum Reference

Table 155: Parameter 2-05 Maximum Reference

| 2-05 Maximum Reference      |   |                               |
|-----------------------------|---|-------------------------------|
| Default value: Size related | Parameter type: Range, par. 3-02 - 999999.999 Reference- FeedbackUnit | Setup: All setups             |
| Conversion index: -3        | Data type: Int32  | Change during operation: True |

This is an access parameter to *parameter 3-03 Maximum Reference* for legacy products. The maximum reference is the highest value obtainable by summing all references. The maximum reference unit matches the option selected in *parameter 1-00 Configuration Mode* and the unit in *parameter 3-01 Reference/Feedback Unit*.

Parameter 2-06 Parking Current

Table 156: Parameter 2-06 Parking Current

| 2-06 Parking Current |                                  |                               |
|----------------------|----------------------------------|-------------------------------|
| Default value: 50%   | Parameter type: Range, 0 - 1000% | Setup: All setups             |
| Conversion index: 0  | Data type: Uint32                | Change during operation: True |

Set current as percentage of rated motor current, *parameter 1-24 Motor Current*. Is used when enabled in *parameter 1-70 Start Mode*.  
 Parameter 2-07 Parking Time

Table 157: Parameter 2-07 Parking Time

| 2-07 Parking Time    |                                   |                               |
|----------------------|-----------------------------------|-------------------------------|
| Default value: 3 s   | Parameter type: Range, 0.1 - 60 s | Setup: All setups             |
| Conversion index: -1 | Data type: Uint16                 | Change during operation: True |

Set the duration of the parking current set in *parameter 2-06 Parking Current*, once activated.

### 5.3.2 2-1\* Brake Energy Funct.

Parameter group for selecting dynamic brake parameters. Only valid for drives with brake chopper.

Parameter 2-10 Brake Function

Table 158: Parameter 2-10 Brake Function

| 2-10 Brake Function               |                        |                               |
|-----------------------------------|------------------------|-------------------------------|
| Default value: [1] Resistor brake | Parameter type: Option | Setup: All setups             |
| Conversion index: -               | Data type: Uint8       | Change during operation: True |

| Op-tion   | Name           | Description   |
|---|----------------|---|
| [0]   | Off            | No brake resistor installed.  |
| [1]*  | Resistor brake | A brake resistor is incorporated in the system for dissipation of surplus brake energy as heat. Connecting a brake resistor allows a higher DC-link voltage during braking (generating operation). The resistor brake function is only active in drives with an integral dynamic brake.   |
| [2]   | AC brake       | Improves braking without using a brake resistor. This parameter controls an overmagnetization of the motor when running with a generative load. This function can improve the OVC function. Increasing the electrical losses in the motor allows the OVC function to increase the braking torque without exceeding the overvoltage limit. |
| <div style="background-color: #cccccc; padding: 5px; margin: 10px auto; width: 80%;"> <p style="margin: 0;"><b>NOTICE</b></p> <p style="margin: 0;">The AC brake is not as efficient as dynamic braking with resistor. AC brake is for VVC+ mode in both open and closed loop.</p> </div> |                |   |

Parameter 2-11 Brake Resistor (ohm)

Table 159: Parameter 2-11 Brake Resistor (ohm)

| 2-11 Brake Resistor (ohm)   |                                      |                               |
|-----------------------------|--------------------------------------|-------------------------------|
| Default value: Size related | Parameter type: Range, 0 - 65535 Ohm | Setup: All setups             |
| Conversion index: 0         | Data type: Uint16                    | Change during operation: True |

Set the brake resistor value in  $\Omega$ . This value is used for monitoring the power to the brake resistor in *parameter 2-13 Brake Power Monitoring*. This parameter is only active in drives with an integral dynamic brake. Use this parameter for values without decimals. For a selection with 2 decimals, use *parameter 30-81 Brake Resistor (ohm)*.

Parameter 2-12 Brake Power Limit (kW)

Table 160: Parameter 2-12 Brake Power Limit (kW)

| 2-12 Brake Power Limit (kW) |  |                               |
|-----------------------------|--|-------------------------------|
| Default value: Size related | Parameter type: Range, 0.001 - 2000.000 kW | Setup: All setups             |
| Conversion index: 0         | Data type: Uint32                          | Change during operation: True |

Parameter 2-12 Brake Power Limit (kW) is the expected average power dissipated in the brake resistor over a period of 120 s. It is used as the monitoring limit for parameter 16-33 Brake Energy Average and thereby specifies when a warning/alarm is to be given. To calculate parameter 2-12 Brake Power Limit (kW), the following formula can be used.

$$P_{br,avg}[W] = \frac{U_{br}^2[V] \times t_{br}[s]}{R_{br}[\Omega] \times T_{br}[s]}$$

$P_{br,avg}$  is the average power dissipated in the brake resistor.  $R_{br}$  is the resistance of the brake resistor.  $t_{br}$  is the active braking time within the 120 s period,  $T_{br}$ .  $U_{br}$  is the DC voltage where the brake resistor is active. This depends on the unit as follows:

- T2 units: 390 V
- T4 units: 810 V
- T5 units: 810 V
- T6 units: 943 V/1099 V for D–F enclosures
- T7 units: 1099 V

**NOTICE**

If  $R_{br}$  is not known, or if  $T_{br}$  is different from 120 s, the practical approach is to run the brake application, read parameter 16-33 Brake Energy Average and then enter this + 20% in parameter 2-12 Brake Power Limit (kW).

Parameter 2-13 Brake Power Monitoring

Table 161: Parameter 2-13 Brake Power Monitoring

| 2-13 Brake Power Monitoring |                        |                               |
|-----------------------------|------------------------|-------------------------------|
| Default value: [0] Off      | Parameter type: Option | Setup: All setups             |
| Conversion index: –         | Data type: Uint8       | Change during operation: True |

This parameter is only active in drives with a brake. This parameter enables monitoring of the power to the brake resistor. The power is calculated based on the resistance (parameter 2-11 Brake Resistor (ohm)), the DC-link voltage, and the resistor duty time. If power monitoring is set to [0] Off or [1] Warning, the brake function remains active, even if the monitoring limit is exceeded. This may lead to thermal overload of the resistor. It is also possible to generate a warning via a relay/digital output. The measuring accuracy of the power monitoring depends on the accuracy of the resistance of the resistor (better than ±20%).

| Option | Name                | Description   |
|--------|---------------------|---|
| [0]*   | Off                 | No brake power monitoring required.   |
| [1]    | Warning 120s        | Activates a warning on the display when the power transmitted during the duty time exceeds 100% of the monitoring limit (parameter 2-12 Brake Power Limit (kW)). The warning disappears when the transmitted power drops below 80% of the monitoring limit. |
| [2]    | Trip 120s           | Trips the drive and shows an alarm when the calculated power exceeds 100% of the monitoring limit.  |
| [3]    | Warning & Trip 120s | Activates both of the above, including warning, trip, and alarm.  |
| [4]    | Warning 30s         |   |
| [5]    | Trip 30s            |   |

| Option | Name                | Description |
|--------|---------------------|-------------|
| [6]    | Warning & trip 30s  |             |
| [7]    | Warning 60s         |             |
| [8]    | Trip 60s            |             |
| [9]    | Warning & trip 60s  |             |
| [10]   | Warning 300s        |             |
| [11]   | Trip 300s           |             |
| [12]   | Warning & trip 300s |             |
| [13]   | Warning 600s        |             |
| [14]   | Trip 600s           |             |
| [15]   | Warning & trip 600s |             |

Parameter 2-14 Brake Voltage Reduce

Table 162: Parameter 2-14 Brake Voltage Reduce

| 2-14 Brake Voltage Reduce |                                  |                               |
|---------------------------|----------------------------------|-------------------------------|
| Default value: 0          | Parameter type: Range, 0 - 200 V | Setup: All setups             |
| Conversion index: 0       | Data type: Uint16                | Change during operation: True |

This parameter can reduce the DC voltage where the brake resistor is active. It is only valid for T4 units. Setting this parameter may change the brake resistor (*parameter 2-11 Brake Resistor (ohm)*).

Parameter 2-15 Brake Check

Table 163: Parameter 2-15 Brake Check

| 2-15 Brake Check       |                        |                               |
|------------------------|------------------------|-------------------------------|
| Default value: [0] Off | Parameter type: Option | Setup: All setups             |
| Conversion index: –    | Data type: Uint8       | Change during operation: True |

*Parameter 2-15 Brake Check* is only active in drives with an integral dynamic brake. Select type of test and monitoring function to check the connection to the brake resistor, or whether a brake resistor is present, and then show a warning or an alarm in the event of a fault.

**NOTICE**

The brake resistor disconnection function is tested during power-up. However, the brake IGBT test is performed when there is no braking. A warning or trip disconnects the brake function.

The testing sequence is as follows:

- 1: The DC-link ripple amplitude is measured for 300 ms without braking.
- 2: The DC-link ripple amplitude is measured for 300 ms with the brake turned on.
  - If the DC-link ripple amplitude while braking is lower than the DC-link ripple amplitude before braking +1%: *Brake check has failed by returning a warning or alarm.*
  - If the DC-link ripple amplitude while braking is higher than the DC-link ripple amplitude before braking +1%: *Brake check is OK.*

**NOTICE**

Remove a warning arising with [0] Off or [1] Warning by cycling the mains supply. The fault must be corrected first. For [0] Off or [1] Warning, the drive keeps running even if a fault is located.

| Option | Name          | Description  |
|--------|---------------|--|
| [0]*   | Off           | Monitors brake resistor and brake IGBT for a short circuit during operation. If a short circuit occurs, <i>Warning 25 Brake resistor shortcircuited</i> appears.   |
| [1]    | Warning       | Monitors brake resistor and brake IGBT for a short circuit and runs a test for brake resistor disconnection during power-up.   |
| [2]    | Trip          | Monitors for a short circuit or disconnection of the brake resistor, or a short circuit of the brake IGBT. If a fault occurs, the drive cuts out while showing an alarm (trip lock).   |
| [3]    | Stop and trip | Monitors for a short circuit or disconnection of the brake resistor, or a short circuit of the brake IGBT. If a fault occurs, the drive ramps down to coast and then trips. A trip lock alarm is shown (for example, warnings 25, 27, or 28).  |
| [4]    | AC brake      | <div style="text-align: center;"><b>NOTICE</b></div> <p>This option is only available with FC 302.</p> <p>Monitors for a short circuit or disconnection of the brake resistor, or a short circuit of the brake IGBT. If a fault occurs, the drive performs a controlled ramp-down.</p> |
| [5]    | Trip lock     |  |

Parameter 2-16 AC Brake Max. Current

Table 164: Parameter 2-16 AC Brake Max. Current

| 2-16 AC Brake Max. Current |                                    |                               |
|----------------------------|------------------------------------|-------------------------------|
| Default value: 100%        | Parameter type: Range, 0 - 1000.0% | Setup: All setups             |
| Conversion index: -1       | Data type: Uint32                  | Change during operation: True |

Enter the maximum allowed current when using AC braking to avoid overheating of motor windings.

**NOTICE**

Parameter 2-16 AC brake Max. Current has no effect when parameter 1-10 Motor Construction=[1] PM, non salient SPM.

Parameter 2-17 Over-voltage Control

Table 165: Parameter 2-17 Over-voltage Control

| 2-17 Over-voltage Control   |                        |                               |
|-----------------------------|------------------------|-------------------------------|
| Default value: [0] Disabled | Parameter type: Option | Setup: All setups             |
| Conversion index: -         | Data type: Uint8       | Change during operation: True |

Overvoltage control (OVC) reduces the risk of the drive tripping due to an overvoltage on the DC-link caused by generative power from the load.

**NOTICE**

Do not enable OVC in hoisting applications.

| Option | Name                  | Description  |
|--------|-----------------------|--|
| [0]*   | Disabled              | No OVC required.   |
| [1]    | Enabled (not at stop) | Activates OVC except when using a stop signal to stop the drive. |
| [2]    | Enabled               | Activates OVC.   |

## Parameter 2-18 Brake Check Condition

Table 166: Parameter 2-18 Brake Check Condition

| 2-18 Brake Check Condition     |                        |                               |
|--------------------------------|------------------------|-------------------------------|
| Default value: [0] At power up | Parameter type: Option | Setup: All setups             |
| Conversion index: –            | Data type: Uint8       | Change during operation: True |

| Option | Name                   | Description                                      |
|--------|------------------------|--|
| [0]*   | At power up            | Brake check at power-up.                         |
| [1]    | After coast situations | Brake check is performed after coast situations. |

## Parameter 2-19 Over-voltage Gain

Table 167: Parameter 2-19 Over-voltage Gain

| 2-19 Over-voltage Gain |                                  |                               |
|------------------------|----------------------------------|-------------------------------|
| Default value: 100%    | Parameter type: Range, 10 - 200% | Setup: All setups             |
| Conversion index: 0    | Data type: Uint16                | Change during operation: True |

Select overvoltage gain.

## 5.3.3 2-2\* Mechanical Brake

Parameters for controlling operation of an electro-magnetic (mechanical) brake, typically required in hoisting applications.

To control a mechanical braking, a relay output (relay 01 or relay 02) or a programmed digital output (terminal 27 or 29) is required. Normally, this output must be closed during periods when the drive is unable to hold the motor, for example due to an excessive load.

Select [32] *Mechanical Brake Control* for applications with an electro-magnetic brake in *parameter 5-40 Function Relay*, *parameter 5-30 Terminal 27 Digital Output*, or *parameter 5-31 Terminal 29 Digital Output*. When selecting [32] *Mechanical brake control*, the mechanical braking is closed from start-up until the output current is above the level selected in *parameter 2-20 Release Brake Current*. During stop, the mechanical braking activates when the speed drops below the level specified in *parameter 2-21 Activate Brake Speed [RPM]*. If the drive enters an alarm condition, an overcurrent, or overvoltage situation, the mechanical braking immediately cuts in. This is also the case during Safe Torque Off.

## N O T I C E

Protection mode and trip delay features (*parameter 14-25 Trip Delay at Torque Limit* and *parameter 14-26 Trip Delay at Inverter Fault*) may delay the activation of the mechanical braking in an alarm condition. These features must be disabled in hoisting applications.

e30ba074.13

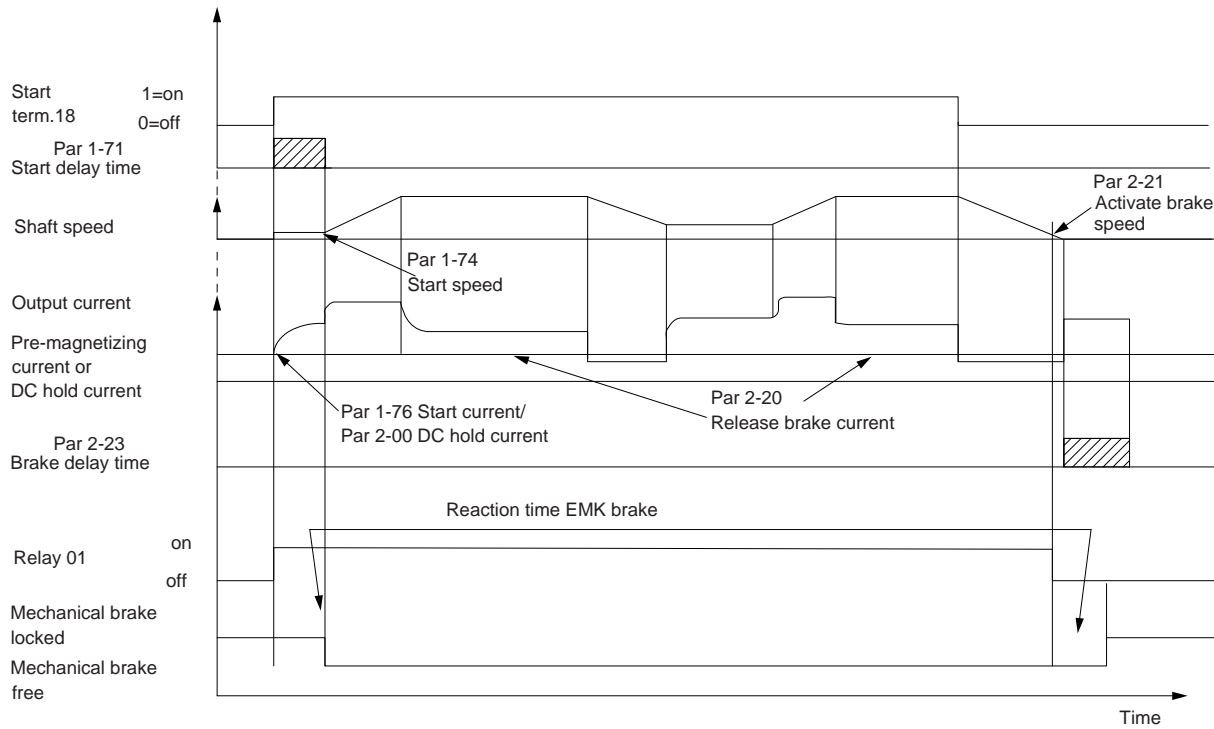

Illustration 45: Mechanical Braking

Parameter 2-20 Release Brake Current

Table 168: Parameter 2-20 Release Brake Current

| 2-20 Release Brake Current  |  |                               |
|-----------------------------|--|-------------------------------|
| Default value: Size related | Parameter type: Range, 10 - par. 16-37 A | Setup: All setups             |
| Conversion index: -2        | Data type: Uint32                        | Change during operation: True |

Set the motor current for release of the mechanical braking when a start condition is present. The default value is the maximum current the inverter can provide for the particular power size. The upper limit is specified in *parameter 16-37 Inv. Max. Current*.

**NOTICE**

When mechanical brake control output is selected, but no mechanical braking is connected, the function does not work by default setting due to too low motor current.

Parameter 2-21 Activate Brake Speed [RPM]

Table 169: Parameter 2-21 Activate Brake Speed [RPM]

| 2-21 Activate Brake Speed [RPM] |  |                               |
|---------------------------------|--|-------------------------------|
| Default value: Size related     | Parameter type: Range, 0 - par. 4-53 RPM | Setup: All setups             |
| Conversion index: 67            | Data type: Uint16                        | Change during operation: True |

Set the motor speed for activation of the mechanical braking when a stop condition is present.

## Parameter 2-22 Activate Brake Speed [Hz]

Table 170: Parameter 2-22 Activate Brake Speed [Hz]

| 2-22 Activate Brake Speed [Hz] |                                      |                               |
|--------------------------------|--------------------------------------|-------------------------------|
| Default value: Size related    | Parameter type: Range, 0 - 5000.0 Hz | Setup: All setups             |
| Conversion index: -1           | Data type: Uint16                    | Change during operation: True |

Set the motor frequency for activation of the mechanical braking when a stop condition is present.

## Parameter 2-23 Activate Brake Delay

Table 171: Parameter 2-23 Activate Brake Delay

| 2-23 Activate Brake Delay |                                |                               |
|---------------------------|--------------------------------|-------------------------------|
| Default value: 0 s        | Parameter type: Range, 0 - 5 s | Setup: All setups             |
| Conversion index: -1      | Data type: Uint8               | Change during operation: True |

Enter the brake delay time of the coast after ramp-down time. The shaft is held at 0 speed with full holding torque. Ensure that the mechanical braking has locked the load before the motor enters coast mode. To adjust transition of the load to the mechanical braking, set *parameter 2-23 Activate Brake Delay* and *parameter 2-24 Stop Delay*. Setting of brake delay parameters does not affect the torque. The drive does not register that mechanical braking is holding the load. After setting *parameter 2-23 Activate Brake Delay*, the torque drops to 0 after a few minutes. The sudden torque change leads to movement and noise.

## Parameter 2-24 Stop Delay

Table 172: Parameter 2-24 Stop Delay

| 2-24 Stop Delay      |                                |                               |
|----------------------|--------------------------------|-------------------------------|
| Default value: 0 s   | Parameter type: Range, 0 - 5 s | Setup: All setups             |
| Conversion index: -1 | Data type: Uint8               | Change during operation: True |

Set the time interval from the moment when the motor is stopped until the brake closes. To adjust transition of the load to the mechanical braking, set *parameter 2-23 Activate Brake Delay* and *parameter 2-24 Stop Delay*. This parameter is a part of the stop function.

## Parameter 2-25 Brake Release Time

Table 173: Parameter 2-25 Brake Release Time

| 2-25 Brake Release Time |                                |                               |
|-------------------------|--------------------------------|-------------------------------|
| Default value: 0.20 s   | Parameter type: Range, 0 - 5 s | Setup: All setups             |
| Conversion index: -2    | Data type: Uint16              | Change during operation: True |

This value defines the time it takes for the mechanical brake to open. This parameter must act as a timeout when brake feedback is activated.

## Parameter 2-26 Torque Ref

Table 174: Parameter 2-26 Torque Ref

| 2-26 Torque Ref      |                                    |                               |
|----------------------|------------------------------------|-------------------------------|
| Default value: 0%    | Parameter type: Range, -300 - 300% | Setup: All setups             |
| Conversion index: -2 | Data type: Int16                   | Change during operation: True |

The value defines the torque applied against the closed mechanical brake before release. The torque/load on a crane is positive and is 10–160%. To obtain the best starting point, set *parameter 2-26 Torque Ref* to approximately 70%. The torque/load on a lift can be both positive and negative and between -160% and +160%. To obtain the best starting point, set *parameter 2-26 Torque Ref* to 0%. The higher the torque error is (*parameter 2-26 Torque Ref* vs. actual torque), the more movement during load takeover.



## Parameter 2-27 Torque Ramp Up Time

Table 175: Parameter 2-27 Torque Ramp Up Time

| 2-27 Torque Ramp Up Time |                                |                               |
|--------------------------|--------------------------------|-------------------------------|
| Default value: 0.2 s     | Parameter type: Range, 0 - 5 s | Setup: All setups             |
| Conversion index: -1     | Data type: Uint8               | Change during operation: True |

The value defines the duration of the torque ramp in clockwise direction. Value 0 enables very fast magnetization in flux control principle.

## Parameter 2-28 Gain Boost Factor

Table 176: Parameter 2-28 Gain Boost Factor

| 2-28 Gain Boost Factor |                              |                               |
|------------------------|------------------------------|-------------------------------|
| Default value: 1       | Parameter type: Range, 0 - 4 | Setup: All setups             |
| Conversion index: -2   | Data type: Uint16            | Change during operation: True |

Only active in flux closed loop. The function ensures a smooth transition from torque control mode to speed control mode when the motor takes over the load from the brake. Increase to minimize the movement. Activate the advanced mechanical braking (*parameter group 2-3\* Adv. Mech Brake*) by setting *parameter 2-28 Gain Boost Factor* to 0.

## Parameter 2-29 Torque Ramp Down Time

Table 177: Parameter 2-29 Torque Ramp Down Time

| 2-29 Torque Ramp Down Time |                                |                               |
|----------------------------|--------------------------------|-------------------------------|
| Default value: 0 s         | Parameter type: Range, 0 - 5 s | Setup: All setups             |
| Conversion index: -1       | Data type: Uint8               | Change during operation: True |

Torque ramp-down time.

### 5.3.3.1 Hoist Mechanical Brake

The hoist mechanical brake control supports the following functions:

- 2 channels for mechanical braking feedback to offer further protection against unintended behavior resulting from broken cable.
- Monitoring of mechanical braking feedback throughout the complete cycle. This helps protect the mechanical brake, especially if more drives are connected to the same shaft.
- No ramp-up until feedback confirms that mechanical brake is open.
- Improved load control at stop. If the value of *parameter 2-23 Activate Brake Delay* is too low, *Warning 22, Hoist mech. brake* is activated and the torque is not allowed to ramp down.
- The transition when motor takes over the load from the brake can be configured. *Parameter 2-28 Gain Boost Factor* can be increased to minimize the movement. To achieve smooth transition, change the setting from the speed control to the position control during the changeover.
- Set *parameter 2-28 Gain Boost Factor* to 0 to enable position control during *parameter 2-02 DC Braking Time*. This enables *parameter 2-30 Position P Start Proportional Gain* to *parameter 2-33 Speed PID Start Lowpass Filter Time*, which are PID parameters for the position control.

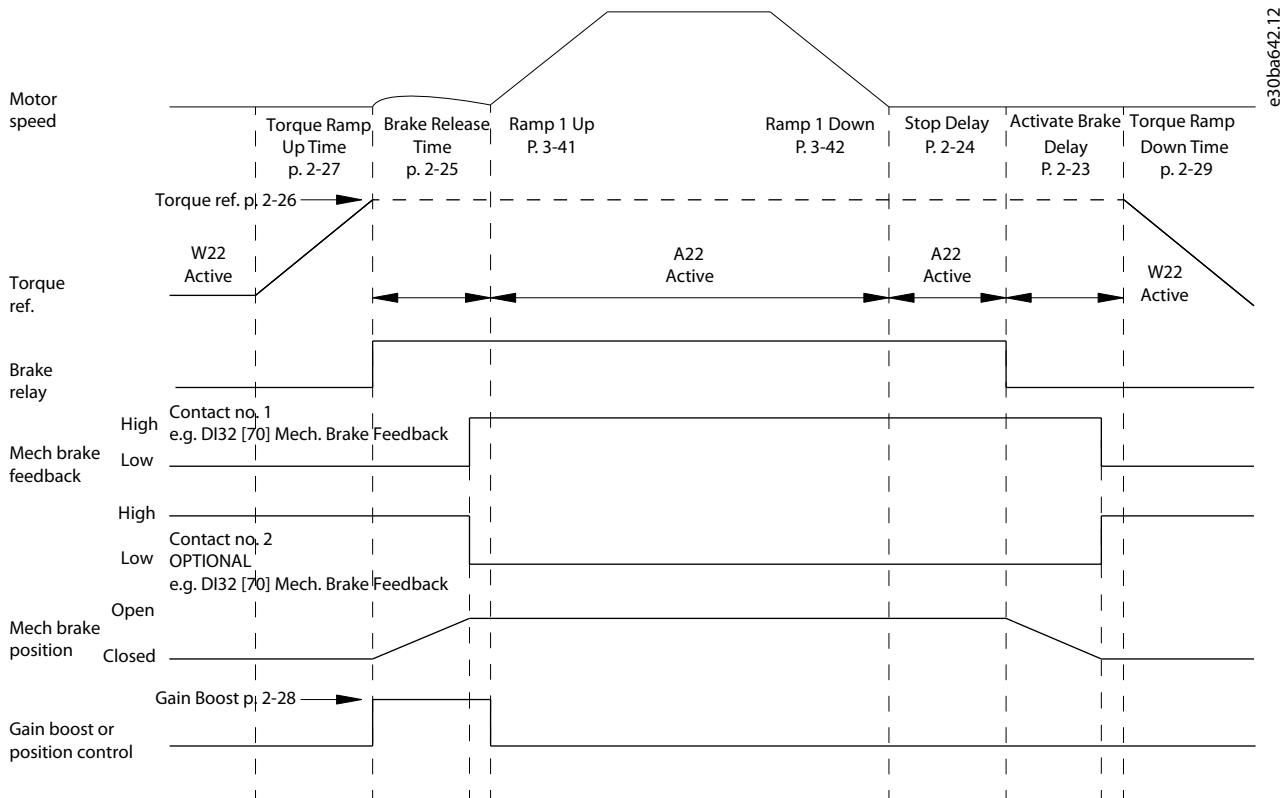

e30ba642.12

Illustration 46: Brake Release Sequence for Hoist Mechanical Brake Control

Parameter 2-26 Torque Ref to parameter 2-33 Speed PID Start Lowpass Filter Time are only available for the hoist mechanical brake control (flux with motor feedback).

### 5.3.4 2-3\* Adv. Mech Brake

Parameter 2-30 Position P Start Proportional Gain to parameter 2-33 Speed PID Start Lowpass Filter Time can be set up for very smooth transition change from speed control to position control during parameter 2-25 Brake Release Time - the time when the load is transferred from the mechanical brake to the drive. Parameter 2-30 Position P Start Proportional Gain to parameter 2-33 Speed PID Start Lowpass Filter Time are activated when parameter 2-28 Gain Boost Factor is set to 0. See [Illustration 46](#) for more information.

Parameter 2-30 Position P Start Proportional Gain

Table 178: Parameter 2-30 Position P Start Proportional Gain

| 2-30 Position P Start Proportional Gain |  |                               |
|---|--|-------------------------------|
| Default value: X0.0500                  | Parameter type: Range, 0.0000 - 1.0000 | Setup: All setups             |
| Conversion index: -4                    | Data type: Uint32                      | Change during operation: True |

Enter the position controller during start proportional gain. Quick control is obtained at high amplification. However, if the amplification is too high, the process may become unstable.

Parameter 2-31 Speed PID Start Proportional Gain

Table 179: Parameter 2-31 Speed PID Start Proportional Gain

| 2-31 Speed PID Start Proportional Gain |  |                               |
|--|--|-------------------------------|
| Default value: 0.0500                  | Parameter type: Range, 0.0000 - 1.0000 | Setup: All setups             |
| Conversion index: -4                   | Data type: Uint32                      | Change during operation: True |

Enter the speed controller proportional gain during start. Quick control is obtained at high amplification. However, if amplification is too high, the process may become unstable.

## Parameter 2-32 Speed PID Start Integral Time

Table 180: Parameter 2-32 Speed PID Start Integral Time

| 2-32 Speed PID Start Integral Time |   |                               |
|------------------------------------|---|-------------------------------|
| Default value: 20.0 ms             | Parameter type: Range, 1.0 - 20000.0 ms | Setup: All setups             |
| Conversion index: -4               | Data type: Uint32                       | Change during operation: True |

Enter the speed controller integral time. Obtain quick control through a short integral time, though if the integral time is too short, the process becomes unstable. An excessively long integral time disables the integral action.

## Parameter 2-33 Speed PID Start Lowpass Filter Time

Table 181: Parameter 2-33 Speed PID Start Lowpass Filter Time

| 2-33 Speed PID Start Lowpass Filter Time |                                       |                               |
|--|---------------------------------------|-------------------------------|
| Default value: 2.0 ms                    | Parameter type: Range, 0.1 - 100.0 ms | Setup: All setups             |
| Conversion index: -4                     | Data type: Uint16                     | Change during operation: True |

Set a time constant for the speed control low-pass filter. The low-pass filter improves steady-state performance and dampens oscillations on the feedback signal. However, severe filtering can be detrimental to dynamic performance.

## Parameter 2-34 Zero Speed Position P Proportional Gain

Table 182: Parameter 2-34 Zero Speed Position P Proportional Gain

| 2-34 Zero Speed Position P Proportional Gain |  |                               |
|--|--|-------------------------------|
| Default value: 0.0000                        | Parameter type: Range, 0.0000 - 1.0000 | Setup: All setups             |
| Conversion index: -4                         | Data type: Uint32                      | Change during operation: True |

## N O T I C E

This parameter is only available with software version 48.XX.

Enter the proportional gain for position control at standstill in speed mode.

## 5.4 Parameter Group 3-\*\* Reference/Ramps

Parameters for handling of reference, definition of limitations, and configuration of the reaction of the drive to changes.

### 5.4.1 3-0\* Reference Limits

#### Parameter 3-00 Reference Range

Table 183: Parameter 3-00 Reference Range

| 3-00 Reference Range        |                        |                               |
|-----------------------------|------------------------|-------------------------------|
| Default value: Size related | Parameter type: Option | Setup: All setups             |
| Conversion index: -         | Data type: Uint8       | Change during operation: True |

Select the range of the reference signal and the feedback signal. Signal values can be positive only, or positive and negative. The minimum limit may have a negative value, unless [1] *Speed closed loop control* or [3] *Process* is selected in *parameter 1-00 Configuration Mode*.

| Option | Name        | Description  |
|--------|-------------|--|
| [0]    | Min - Max   | Select the range of the reference signal and the feedback signal. Signal values can be positive only, or positive and negative. The minimum limit may have a negative value, unless [1] <i>Speed closed loop control</i> or [3] <i>Process</i> is selected in <i>parameter 1-00 Configuration Mode</i> . |
| [1]    | -Max - +Max | For both positive and negative values (both directions, relative to <i>parameter 4-10 Motor Speed Direction</i> ).   |

## Parameter 3-01 Reference/Feedback Unit

Table 184: Parameter 3-01 Reference/Feedback Unit

| 3-01 Reference/Feedback Unit |                        |                               |
|------------------------------|------------------------|-------------------------------|
| Default value: Size related  | Parameter type: Option | Setup: All setups             |
| Conversion index: –          | Data type: Uint8       | Change during operation: True |

Select the unit to be used in process PID control references and feedbacks. *Parameter 1-00 Configuration Mode* must be either [3] *Process* or [8] *Extended PID Control*.

| Option | Name                | Description |
|--------|---------------------|-------------|
| [0]    | None                |             |
| [1]    | %                   |             |
| [2]    | RPM                 |             |
| [3]    | Hz                  |             |
| [4]    | Nm                  |             |
| [5]    | PPM                 |             |
| [10]   | l/min               |             |
| [12]   | Pulse/s             |             |
| [20]   | l/s                 |             |
| [21]   | l/min               |             |
| [22]   | l/h                 |             |
| [23]   | m <sup>3</sup> /s   |             |
| [24]   | m <sup>3</sup> /min |             |
| [25]   | m <sup>3</sup> /h   |             |
| [30]   | kg/s                |             |
| [31]   | kg/min              |             |
| [32]   | kg/h                |             |
| [33]   | t/min               |             |
| [34]   | t/h                 |             |
| [40]   | m/s                 |             |
| [41]   | m/min               |             |
| [45]   | m                   |             |

| Option | Name                 | Description |
|--------|----------------------|-------------|
| [60]   | °C                   |             |
| [70]   | mbar                 |             |
| [71]   | bar                  |             |
| [72]   | Pa                   |             |
| [73]   | kPa                  |             |
| [74]   | m WG                 |             |
| [80]   | kW                   |             |
| [120]  | GPM                  |             |
| [121]  | gal/s                |             |
| [122]  | gal/min              |             |
| [123]  | gal/h                |             |
| [124]  | CFM                  |             |
| [125]  | ft <sup>3</sup> /s   |             |
| [126]  | ft <sup>3</sup> /min |             |
| [127]  | ft <sup>3</sup> /h   |             |
| [130]  | lb/s                 |             |
| [131]  | lb/min               |             |
| [132]  | lb/h                 |             |
| [140]  | ft/s                 |             |
| [141]  | ft/min               |             |
| [145]  | ft                   |             |
| [150]  | lb ft                |             |
| [160]  | °F                   |             |
| [170]  | psi                  |             |
| [171]  | lb/in <sup>3</sup>   |             |
| [172]  | in WG                |             |
| [173]  | ft WG                |             |
| [180]  | HP                   |             |

## Parameter 3-02 Minimum Reference

Table 185: Parameter 3-02 Minimum Reference

| 3-02 Minimum Reference      |  |                               |
|-----------------------------|--|-------------------------------|
| Default value: Size related | Parameter type: Range, -999999.999 - 999999.999 Reference- Feed-backUnit | Setup: All setups             |
| Conversion index: -3        | Data type: Int32   | Change during operation: True |

Enter the minimum reference. The minimum reference is the lowest value obtainable by summing all references. Minimum reference is active only when *parameter 3-00 Reference Range* is set to [0] Min.- Max. The minimum reference unit matches:

- The configuration of *parameter 1-00 Configuration Mode*: For [1] Speed closed loop, RPM; for [2] Torque, Nm.
- The unit selected in *parameter 3-01 Reference/ Feedback Unit*.

If option [10] Synchronization is selected in *parameter 1-00 Configuration Mode*, this parameter defines the maximum speed deviation when performing the position offset defined in *parameter 3-26 Master Offset*. Also see *parameter 3-28 Master Offset Speed Ref*.  
Parameter 3-03 Maximum Reference

Table 186: Parameter 3-03 Maximum Reference

| 3-03 Maximum Reference      |  |                               |
|-----------------------------|--|-------------------------------|
| Default value: Size related | Parameter type: 0.000 - 999999.999 Reference- FeedbackUnit | Setup: All setups             |
| Conversion index: -3        | Data type: Int32   | Change during operation: True |

Enter the maximum reference. The maximum reference is the highest value obtainable by summing all references. The maximum reference unit matches:

- The configuration selected in *parameter 1-00 Configuration Mode*: For [1] Speed closed loop, RPM; for [2] Torque, Nm.
- The unit selected in *parameter 3-00 Reference Range*.

If [9] Positioning is selected in *parameter 1-00 Configuration Mode*, this parameter defines the default speed for positioning.

## Parameter 3-04 Reference Function

Table 187: Parameter 3-04 Reference Function

| 3-04 Reference Function |                        |                               |
|-------------------------|------------------------|-------------------------------|
| Default value: [0] Sum  | Parameter type: Option | Setup: All setups             |
| Conversion index: –     | Data type: Uint8       | Change during operation: True |

| Option | Name            | Description   |
|--------|-----------------|---|
| [0]*   | Sum             | Sums both external and preset reference sources.  |
| [1]    | External/Preset | Use either the preset or the external reference source. Shift between external and preset via a command or a digital input. |

## Parameter 3-05 On Reference Window

Table 188: Parameter 3-05 On Reference Window

| 3-05 On Reference Window    |   |                               |
|-----------------------------|---|-------------------------------|
| Default value: Size related | Parameter type: Range, 0 - 999999.999 Reference- FeedbackUnit | Setup: All setups             |
| Conversion index: -3        | Data type: Int32  | Change during operation: True |

## NOTICE

This parameter is only available with software version 48.XX

Enter the tolerance window for on-reference or on-target status. Depending on the option selected in *parameter 1-00 Configuration Mode*, this parameter defines the following:

- Speed mode: Speed window for on-reference status.
- Torque mode: Torque window for on-reference status.
- Position mode: Speed window for on-target status. See also *parameter 3-08 On Target Window*.

### Parameter 3-06 Minimum Position

Table 189: Parameter 3-06 Minimum Position

| 3-06 Minimum Position                        |  |                               |
|--|--|-------------------------------|
| Default value: -100000 Custom- Readout-Unit2 | Parameter type: Range, -2147483648 - 2147483647 CustomReadoutUnit2 | Setup: All setups             |
| Conversion index: 0                          | Data type: Int32   | Change during operation: True |

## NOTICE

This parameter is only available with software version 48.XX

Enter the minimum position. This parameter defines the position range in linear axis mode (*parameter 17-76 Position Axis Mode*) and in the position limit function (*parameter 4-73 Position Limit Function*).

### Parameter 3-07 Maximum Position

Table 190: Parameter 3-07 Maximum Position

| 3-07 Maximum Position                      |  |                               |
|--|--|-------------------------------|
| Default value: 100000 Custom- ReadoutUnit2 | Parameter type: Range, -2147483648 - 2147483647 CustomReadoutUnit2 | Setup: All setups             |
| Conversion index: 0                        | Data type: Int32   | Change during operation: True |

## NOTICE

This parameter is only available with software version 48.XX

Enter the maximum position. This parameter defines the position range in linear axis mode (*parameter 17-76 Position Axis Mode*). Position range limits:

- Linear: *Parameter 3-06 Minimum Position* to *parameter 3-07 Maximum Position*.
- Rotary: 0– *parameter 3-07 Maximum Position*.

The position limit function uses this parameter (*parameter 4-73 Position Limit Function*).

### Parameter 3-08 On Target Window

Table 191: Parameter 3-08 On Target Window

| 3-08 On Target Window                 |  |                               |
|---------------------------------------|--|-------------------------------|
| Default value: 5 Custom- ReadoutUnit2 | Parameter type: Range, 0 - 2147483647 CustomReadoutUnit2 | Setup: All setups             |
| Conversion index: 0                   | Data type: Int32   | Change during operation: True |

## NOTICE

This parameter is only available with software version 48.XX

The drive considers the positioning completed and sends the on target signal when the actual position is within *parameter 3-08 On Target Window* for the duration of *parameter 3-09 On Target Time* and the actual speed is less than *parameter 3-05 On Reference Window*.

Parameter 3-09 On Target Time

Table 192: Parameter 3-09 On Target Time

| 3-09 On Target Time  |                                     |                               |
|----------------------|-------------------------------------|-------------------------------|
| Default value: 1 ms  | Parameter type: Range, 0 - 60000 ms | Setup: All setups             |
| Conversion index: -3 | Data type: Uint16                   | Change during operation: True |

**NOTICE**

This parameter is only available with software version 48.XX

Enter the time for evaluating the on-target window, see also *parameter 3-08 On Target Window*.

### 5.4.2 3-1\* References

Select the preset reference(s). Select Preset ref. bit 0/1/2 [16], [17], or [18] for the corresponding digital inputs in *parameter group 5-1\* Digital Inputs*.

Parameter 3-10 Preset Reference

Table 193: Parameter 3-10 Preset Reference

| 3-10 Preset Reference |   |                               |
|-----------------------|---|-------------------------------|
| Default value: 0%     | Parameter type: Range, -100 - 100%, Array [8] | Setup: All setups             |
| Conversion index: -2  | Data type: Int16                              | Change during operation: True |

Enter up to 8 different preset references (0–7) in this parameter, using array programming. The preset reference is stated as a percentage of the value  $Ref_{MAX}$  (*parameter 3-03 Maximum Reference*). If a  $Ref_{MIN}$  different from 0 (*parameter 3-02 Minimum Reference*) is programmed, the preset reference is calculated as a percentage of the full reference range, that is on the basis of the difference between  $Ref_{MAX}$  and  $Ref_{MIN}$ . Afterwards, the value is added to  $Ref_{MIN}$ . When using preset references, select preset reference bit 0/1/2 [16], [17] or [18] for the corresponding digital inputs in *parameter group 5-1\* Digital Inputs*.

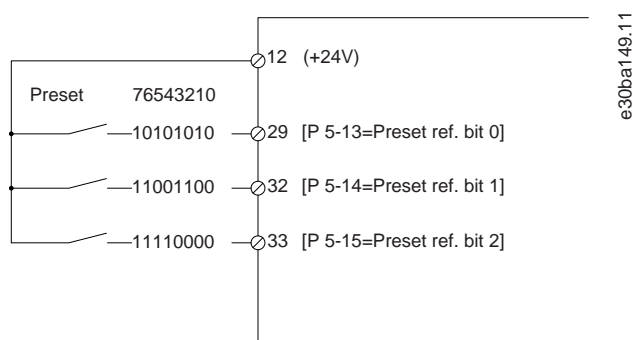

Illustration 47: Preset Reference



Table 194: Preset Reference Bits

| Preset ref. bit | 2 | 1 | 0 |
|-----------------|---|---|---|
| Preset ref. 0   | 0 | 0 | 0 |
| Preset ref. 1   | 0 | 0 | 1 |
| Preset ref. 2   | 0 | 1 | 0 |
| Preset ref. 3   | 0 | 1 | 1 |
| Preset ref. 4   | 1 | 0 | 0 |
| Preset ref. 5   | 1 | 0 | 1 |
| Preset ref. 6   | 1 | 1 | 0 |
| Preset ref. 7   | 1 | 1 | 1 |

## Parameter 3-11 Jog Speed [Hz]

Table 195: Parameter 3-11 Jog Speed [Hz]

| 3-11 Jog Speed [Hz]         |   |                               |
|-----------------------------|---|-------------------------------|
| Default value: Size related | Parameter type: Range, 0 - par. 4-14 Hz | Setup: All setups             |
| Conversion index: -1        | Data type: Uint16                       | Change during operation: True |

The jog speed is a fixed output speed at which the drive is running when the jog function is activated. See also *parameter 3-80 Jog/Homing Ramp Time*.

## Parameter 3-12 Catch Up/Slow Down Value

Table 196: Parameter 3-12 Catch Up/Slow Down Value

| 3-12 Catch Up/Slow Down Value |                                 |                               |
|-------------------------------|---------------------------------|-------------------------------|
| Default value: 0%             | Parameter type: Range, 0 - 100% | Setup: All setups             |
| Conversion index: -2          | Data type: Int16                | Change during operation: True |

Enter a percentage (relative) value to be either added to or deducted from the actual reference for catch up or slow down. If catch up is selected via 1 of the digital inputs (*parameter 5-10 Terminal 18 Digital Input* to *parameter 5-15 Terminal 33 Digital Input*), the percentage (relative) value is added to the total reference. If slow down is selected via 1 of the digital inputs (*parameter 5-10 Terminal 18 Digital Input* to *parameter 5-15 Terminal 33 Digital Input*), the percentage (relative) value is deducted from the total reference. Obtain extended functionality with the DigiPot function. See *parameter group 3-9\* Digital Potentiometer*.

## Parameter 3-13 Reference Site

Table 197: Parameter 3-13 Reference Site

| 3-13 Reference Site                    |                        |                               |
|--|------------------------|-------------------------------|
| Default value: [0] Linked to hand/auto | Parameter type: Option | Setup: All setups             |
| Conversion index: -                    | Data type: Uint8       | Change during operation: True |

Select which reference site to activate.

| Option | Name                | Description   |
|--------|---------------------|---|
| [0]*   | Linked to hand/auto | Use local reference when in hand-on mode, or remote reference when in auto-on mode.   |
| [1]    | Remote              | Use remote reference in both hand-on mode and auto-on mode.   |
| [2]    | Local               | Use local reference in both hand-on and auto-on mode.<br><br><div style="text-align: center; border: 1px solid black; padding: 5px;"> <p><b>NOTICE</b></p> <p>When set to [2] Local, the drive starts with this setting again after a power-down.</p> </div>  |
| [3]    | Linked to H/A MCO   | Select this option to enable the FFACC factor in <i>parameter 32-66 Acceleration Feed-Forward</i> . Enabling FFACC reduces jitter and makes the transmission from the motion controller to the control card of the drive faster. This leads to faster response times for dynamic applications and position control. For more information about FFACC, see VLT® Motion Control MCO 305 Operating Instructions. |

Parameter 3-14 Preset Relative Reference

Table 198: Parameter 3-14 Preset Relative Reference

| 3-14 Preset Relative Reference |                                    |                               |
|--------------------------------|------------------------------------|-------------------------------|
| Default value: 0%              | Parameter type: Range, -200 - 200% | Setup: All setups             |
| Conversion index: -2           | Data type: Int32                   | Change during operation: True |

The actual reference, X, is increased or decreased with percentage Y, which gives the resulting actual reference, Z. The actual reference (X) is the sum of the inputs selected in:

- Parameter 3-15 Reference Resource 1.
- Parameter 3-16 Reference Resource 2.
- Parameter 3-17 Reference Resource 3.
- Parameter 8-02 Control Word Source.

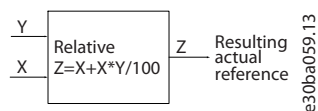

Illustration 48: Preset Relative Reference

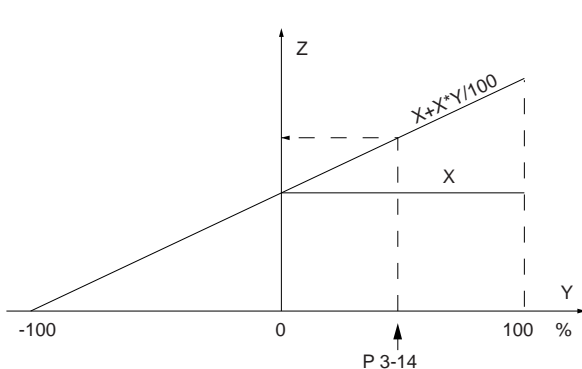

Illustration 49: Actual Reference

Parameter 3-15 Reference Resource 1

Table 199: Parameter 3-15 Reference Resource 1

| 3-15 Reference Resource 1          |                        |                               |
|------------------------------------|------------------------|-------------------------------|
| Default value: [1] Analog input 53 | Parameter type: Option | Setup: All setups             |
| Conversion index: –                | Data type: Uint8       | Change during operation: True |

Select the reference input to be used for the 1<sup>st</sup> reference signal. *Parameter 3-15 Resource Reference 1*, *parameter 3-16 Resource Reference 2*, and *parameter 3-17 Resource Reference 3* define up to 3 different reference signals. The sum of these reference signals defines the actual reference. Select the speed reference source in *parameter 3-15 Reference Resource 1* when *parameter 1-00 Configuration Mode* is set to [9] Positioning in positioning mode.

**NOTICE**

The options [3],[4],[5], [6], [12], [13], and [14] are only available with software version 48.XX.

| Option | Name                | Description  |
|--------|---------------------|--|
| [0]    | No function         |  |
| [1]*   | Analog Input 53     |  |
| [2]    | Analog Input 54     |  |
| [3]    | 24V Encoder 32/33   |  |
| [4]    | MCB 102             |  |
| [5]    | MCB 103             |  |
| [6]    | Virtual Master      |  |
| [7]    | Frequency Input 29  | <p style="text-align: center;"><b>NOTICE</b></p> <p>This option is only available in FC 302.</p>   |
| [8]    | Frequency Input 33  |  |
| [11]   | Local Bus Reference | Reference from terminals 68 and 69.  |
| [12]   | Preset Reference    | Select this option to set the speed reference in <i>parameter 3-10 Preset Reference</i> together with the preset target in <i>parameter 3-20 Preset Target</i> to calculate speed profile for positioning. |
| [13]   | 24V Encoder 27/29   |  |
| [14]   | MCB 102 Absolute    |  |
| [15]   | MCO Encoder 1 X56   |  |
| [16]   | MCO Encoder 2 X55   |  |
| [20]   | Digital Potmeter    |  |
| [21]   | Analog Input X30/11 | VLT® General Purpose I/O MCB 101   |
| [22]   | Analog Input X30/12 | VLT® General Purpose I/O MCB 101   |
| [29]   | Analog Input X48/2  |  |

| Option | Name               | Description |
|--------|--------------------|-------------|
| [37]   | Analog Input X49/1 |             |
| [38]   | Analog Input X49/3 |             |
| [39]   | Analog Input X49/5 |             |

Parameter 3-16 Reference Resource 2

Table 200: Parameter 3-16 Reference Resource 2

| 3-16 Reference Resource 2             |                        |                               |
|---------------------------------------|------------------------|-------------------------------|
| Default value: [20] Digital pot.meter | Parameter type: Option | Setup: All setups             |
| Conversion index: –                   | Data type: Uint8       | Change during operation: True |

Select the reference input to be used for the 2<sup>nd</sup> reference signal. *Parameter 3-15 Resource Reference 1*, *parameter 3-16 Resource Reference 2*, and *parameter 3-17 Resource Reference 3* define up to 3 different reference signals. The sum of these reference signals defines the actual reference. When *parameter 1-00 Configuration Mode* is set to [9] Positioning. Configure *parameter 3-16 Reference Resource 2* to select the source for target position.

**NOTICE**

The options [3],[4],[5], [6], [12], [13], and [14] are only available with software version 48.XX.

| Option | Name                | Description   |
|--------|---------------------|---|
| [0]    | No function         |   |
| [1]    | Analog Input 53     |   |
| [2]    | Analog Input 54     |   |
| [3]    | 24V Encoder 32/33   | Single signal generated from 24 V High Threshold Logic (HTL) encoder connected to terminals 32 and 33. Configure the 24 V encoder interface in <i>parameter group 5–7* 24 V Encoder Option</i> . Program terminals 32/33 to [0] No operation. |
| [4]    | MCB 102             | This is only available for VLT® Encoder Option MCB 102. Configure the encoder interface in <i>parameter groups 17-0*, 17-1*, and 17-2*</i> .  |
| [5]    | MCB 103             | This is only available for VLT® Resolver Option MCB 103. Configure the resolver interface in <i>parameter group 17-5* Resolver Interface</i> .  |
| [6]    | Virtual Master      | Master signal for the drive which hosts the virtual master without an external connection. This option is only active when option [10] Synchronization is selected in <i>parameter 1-00 Configuration Mode</i> .                              |
| [7]    | Frequency Input 29  | <p style="text-align: center;"><b>NOTICE</b></p> <p>This option is only available in FC 302.</p>  |
| [8]    | Frequency Input 33  |   |
| [11]   | Local Bus Reference | Reference from terminals 68 and 69.   |
| [12]   | Preset Reference    |   |

| Option | Name                | Description  |
|--------|---------------------|--|
| [13]   | 24V Encoder 27/29   | Single signal generated from 24 V High Threshold Logic (HTL) encoder connected to terminals 27 and 29. Configure the 24 V encoder interface in <i>parameter group 5.7* 24 V Encoder Input</i> . Program terminals 27/29 to [0] No operation. |
| [14]   | MCB 102 Absolute    | The option is only available for VLT® Encoder Option MCB 102 with version 4.00 and newer and when <i>parameter 17-00 Encoders Connected</i> is set to option [1] Two Encoders.   |
| [15]   | MCO Encoder 1 X56   |  |
| [16]   | MCO Encoder 2 X55   |  |
| [20]*  | Digital Potmeter    |  |
| [21]   | Analog Input X30/11 | VLT® General Purpose I/O MCB 101   |
| [22]   | Analog Input X30/12 | VLT® General Purpose I/O MCB 101   |
| [29]   | Analog Input X48/2  |  |
| [37]   | Analog Input X49/1  |  |
| [38]   | Analog Input X49/3  |  |
| [39]   | Analog Input X49/5  |  |

Parameter 3-17 Reference Resource 3

Table 201: Parameter 3-17 Reference Resource 3

| 3-17 Reference Resource 3               |                        |                               |
|---|------------------------|-------------------------------|
| Default value: [11] Local bus reference | Parameter type: Option | Setup: All setups             |
| Conversion index: –                     | Data type: Uint8       | Change during operation: True |

Select the reference input to be used for the 3<sup>rd</sup> reference signal. *Parameter 3-15 Resource Reference 1*, *parameter 3-16 Resource Reference 2*, and *parameter 3-17 Resource Reference 3* define up to 3 different reference signals. The sum of these reference signals defines the actual reference.

| Option | Name               | Description   |
|--------|--------------------|---|
| [0]    | No function        |   |
| [1]    | Analog Input 53    |   |
| [2]    | Analog Input 54    |   |
| [3]    | 24V Encoder 32/33  |   |
| [4]    | MCB 102            |   |
| [5]    | MCB 103            |   |
| [6]    | Virtual Master     |   |
| [7]    | Frequency Input 29 | <div style="text-align: center; background-color: #cccccc; padding: 5px;"><b>NOTICE</b></div> <div style="border: 1px solid black; padding: 5px; margin-top: 5px;">This option is only available in FC 302.</div> |
| [8]    | Frequency Input 33 |   |

| Option | Name                | Description                         |
|--------|---------------------|-------------------------------------|
| [11]*  | Local Bus Reference | Reference from terminals 68 and 69. |
| [12]   | Preset Reference    |                                     |
| [13]   | 24V Encoder 27/29   |                                     |
| [14]   | MCB 102 Absolute    |                                     |
| [15]   | MCO Encoder 1 X56   |                                     |
| [16]   | MCO Encoder 2 X55   |                                     |
| [20]   | Digital Potmeter    |                                     |
| [21]   | Analog Input X30/11 |                                     |
| [22]   | Analog Input X30/12 |                                     |
| [29]   | Analog Input X48/2  |                                     |
| [37]   | Analog Input X49/1  |                                     |
| [38]   | Analog Input X49/3  |                                     |
| [39]   | Analog Input X49/5  |                                     |

Parameter 3-18 Relative Scaling Reference Resource

Table 202: Parameter 3-18 Relative Scaling Reference Resource

| 3-18 Relative Scaling Reference Resource |                        |                               |
|--|------------------------|-------------------------------|
| Default value: [0] No Function           | Parameter type: Option | Setup: All setups             |
| Conversion index: –                      | Data type: Uint8       | Change during operation: True |

NOTICE

This parameter cannot be adjusted while the motor is running.

NOTICE

The options [3],[4],[5], [6], [12], [13], and [14] are only available with software version 48.XX.

Select a variable value to be added to the fixed value (defined in *parameter 3-14 Preset Relative Reference*). The sum of the fixed and variable values (labeled Y in [Illustration 50](#)) is multiplied by the actual reference (labeled X in [Illustration 50](#)). This product is then added to the actual reference (X+X\*Y/100) to give the resulting actual reference.

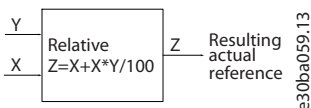

Illustration 50: Resulting Actual Reference

| Option | Name            | Description |
|--------|-----------------|-------------|
| [0]*   | No function     |             |
| [1]    | Analog Input 53 |             |
| [2]    | Analog Input 54 |             |

| Option | Name                | Description   |
|--------|---------------------|---|
| [3]    | 24V Encoder 32/33   |   |
| [4]    | MCB 102             |   |
| [5]    | MCB 103             |   |
| [6]    | Virtual Master      |   |
| [7]    | Frequency Input 29  | <div style="text-align: center; background-color: #cccccc; padding: 5px;"><b>NOTICE</b></div> <div style="border: 1px solid black; padding: 5px; margin-top: 5px;">This option is only available in FC 302.</div> |
| [8]    | Frequency Input 33  |   |
| [11]   | Local Bus Reference | Reference from terminals 68 and 69.   |
| [12]   | Preset Reference    |   |
| [13]   | 24V Encoder 27/29   |   |
| [14]   | MCB 102 Absolute    |   |
| [15]   | MCO Encoder 1 X56   |   |
| [16]   | MCO Encoder 2 X55   |   |
| [20]   | Digital Potmeter    |   |
| [21]   | Analog Input X30/11 |   |
| [22]   | Analog Input X30/12 |   |
| [29]   | Analog Input X48/2  |   |
| [37]   | Analog Input X49/1  |   |
| [38]   | Analog Input X49/3  |   |
| [39]   | Analog Input X49/5  |   |

### Parameter 3-19 Jog Speed [RPM]

Table 203: Parameter 3-19 Jog Speed [RPM]

| 3-19 Jog Speed [RPM]        |  |                               |
|-----------------------------|--|-------------------------------|
| Default value: Size related | Parameter type: Range, 0 - par. 4-13 RPM | Setup: All setups             |
| Conversion index: 67        | Data type: Uint16                        | Change during operation: True |

Enter a value for the jog speed  $n_{JOG}$ , which is a fixed output speed. The drive runs at this speed when the jog function is activated. The maximum limit is defined in *parameter 4-13 Motor Speed High Limit [RPM]*. See also *parameter 3-80 Jog/Homing Ramp Time*.

### 5.4.3 3-2\* References II

#### Parameter 3-20 Preset Target

Table 204: Parameter 3-20 Preset Target

| 3-20 Preset Target                    |   |                               |
|---------------------------------------|---|-------------------------------|
| Default value: 0 Custom- ReadoutUnit2 | Parameter type: Range, -2147483648 - 2147483647 CustomReadoutUnit2, Array [8] | Setup: All setups             |
| Conversion index: 0                   | Data type: Int32  | Change during operation: True |

### N O T I C E

This parameter is only available with software version 48.XX.

Set up to 8 target positions. Select from the 8 preset positions using digital inputs or the fieldbus control word.

#### Parameter 3-21 Touch Target

Table 205: Parameter 3-21 Touch Target

| 3-21 Touch Target                     |   |                               |
|---------------------------------------|---|-------------------------------|
| Default value: 0 Custom- ReadoutUnit2 | Parameter type: Range, -2147483648 - 2147483647 CustomReadoutUnit2, Array [8] | Setup: All setups             |
| Conversion index: 0                   | Data type: Int32  | Change during operation: True |

### N O T I C E

This parameter is only available with software version 48.XX.

2147483647 = Latch Only. With Latch Only actual position of touch sensor is latched and updated in *parameter 18-25 Latched Actual Pos* but no positioning is executed. Enter the target position in touch probe positioning mode. This parameter defines the distance from the detection event of the touch probe sensor to the final target position in position units.

#### Parameter 3-22 Master Scale Numerator

Table 206: Parameter 3-22 Master Scale Numerator

| 3-22 Master Scale Numerator |   |                               |
|-----------------------------|---|-------------------------------|
| Default value: 1            | Parameter type: Range, -2147483648 - 2147483647 | Setup: All setups             |
| Conversion index: 0         | Data type: Int32                                | Change during operation: True |

### N O T I C E

This parameter is only available with software version 48.XX.

*Parameter 3-22 Master Scale Numerator* and *parameter 3-23 Master Scale Denominator* define the gear ratio between the master and the follower in synchronization mode.

$$\text{Master revolutions} = \frac{\text{Par. 3-22}}{\text{Par. 3-23}} \times \text{Follower revolutions}$$

#### Parameter 3-23 Master Scale Denominator

Table 207: Parameter 3-23 Master Scale Denominator

| 3-23 Master Scale Denominator |   |                               |
|-------------------------------|---|-------------------------------|
| Default value: 1              | Parameter type: Range, -2147483648 - 2147483647 | Setup: All setups             |
| Conversion index: 0           | Data type: Int32                                | Change during operation: True |



**NOTICE**

This parameter is only available with software version 48.XX.

Refer to *Parameter 3-22 Master Scale Numerator*.

**Parameter 3-24 Master Lowpass Filter Time**

**Table 208: Parameter 3-24 Master Lowpass Filter Time**

| 3-24 Master Lowpass Filter Time |  |                               |
|---------------------------------|--|-------------------------------|
| Default value: 20 ms            | Parameter type: Range, 1.0 - 2000.0 ms | Setup: All setups             |
| Conversion index: -1            | Data type: Uint16                      | Change during operation: True |

**NOTICE**

This parameter is only available with software version 48.XX.

Enter the time constant for master speed calculation in synchronizing mode.

**Parameter 3-25 Fieldbus Sync. Resolution**

**Table 209: Parameter 3-25 Fieldbus Sync. Resolution**

| 3-25 Fieldbus Sync. Resolution |                                       |                               |
|--------------------------------|---------------------------------------|-------------------------------|
| Default value: 1048576         | Parameter type: Range, 0 - 2147483647 | Setup: All setups             |
| Conversion index: 0            | Data type: Uint32                     | Change during operation: True |

**NOTICE**

This parameter is only available with software version 48.XX.

Set the resolution of the fieldbus reference in synchronization mode. 0 sets the full unsigned 32-bit value,  $2^{32} = 429496729$ .

**Parameter 3-26 Master Offset**

**Table 210: Parameter 3-26 Master Offset**

| 3-26 Master Offset                  |  |                               |
|-------------------------------------|--|-------------------------------|
| Default value: 0 CustomReadoutUnit2 | Parameter type: Range, -2147483648 - 2147483647 CustomReadoutUnit2 | Setup: All setups             |
| Conversion index: 0                 | Data type: Int32   | Change during operation: True |

**NOTICE**

This parameter is only available with software version 48.XX.

Enter the position offset between the master and the follower in synchronization mode. This value is added to the follower position at each activation of a digital input with option [113] *Enable Reference* or bit 5 of the fieldbus control word. *Parameter 3-02 Minimum Reference* defines the maximum deviation from the actual master speed during the execution of the offset.

**Parameter 3-27 Virtual Master Max Ref**

**Table 211: Parameter 3-27 Virtual Master Max Ref**

| 3-27 Virtual Master Max Ref |                                       |                               |
|-----------------------------|---------------------------------------|-------------------------------|
| Default value: 50 Hz        | Parameter type: Range, 0.0 - 590.0 Hz | Setup: All setups             |
| Conversion index: -1        | Data type: Uint16                     | Change during operation: True |

**N O T I C E**

This parameter is only available with software version 48.XX.

Enter the maximum reference for the virtual master. The actual reference is set relative to this value using the source selected in *parameter 3-15 Reference Resource 1* or fieldbus reference 1. The rotation direction is controlled by the forward/reverse signal on a digital input or fieldbus. Use *parameter group 3-6\* Ramp 3* to configure acceleration and deceleration.

**Parameter 3-28 Master Offset Speed Ref**

**Table 212: Parameter 3-28 Master Offset Speed Ref**

| 3-28 Master Offset Speed Ref |                                      |                               |
|------------------------------|--------------------------------------|-------------------------------|
| Default value: 1500 RPM      | Parameter type: Range, 0 - 65000 RPM | Setup: All setups             |
| Conversion index: 67         | Data type: Uint16                    | Change during operation: True |

**N O T I C E**

This parameter is only available with software version 48.XX.

Enter the speed reference for changing the master offset in synchronization mode. To ensure compatibility with software versions 48.01 and 48.10, this parameter is only active when *parameter 3-02 Minimum Reference* is set to 0.

**Parameter 3-29 Interpolation Time Period**

**Table 213: Parameter 3-29 Interpolation Time Period**

| 3-29 Interpolation Time Period |  |                               |
|--------------------------------|--|-------------------------------|
| Default value: Size related    | Parameter type: Range, Size related, Array [2] | Setup: All setups             |
| Conversion index: 0            | Data type: Int16                               | Change during operation: True |

Set the time interval of the cyclic reference for CSV, CSP, or synchronizing. **CSV:** When providing only speed reference. Acceleration/ deceleration is interpolated based on this time interval. **CSP/Synchronizing:** When only providing position reference speed and acceleration/ deceleration is interpolated based on this time interval.

| Index           | Range  | Description   |
|-----------------|--------|---|
| [0], default 1  | 1–1000 | The time period in seconds but actual time is scaled by index 1.  |
| [1], default -3 | -3–0   | The exponent for the time period in index 0. Actual time = index 0 to the power of index 1. Example: Index 0 = 1 and index 1 = -3 ⇒ time set in ms. |

### 5.4.4 3-3\* Gen Ramp & Sync

**Parameter 3-32 Ramp Speed Ref**

**Table 214: Parameter 3-32 Ramp Speed Ref**

| 3-32 Ramp Speed Ref  |  |                               |
|----------------------|--|-------------------------------|
| Default value: 0 RPM | Parameter type: Range, 0 - 1000000 RPM | Setup: All setups             |
| Conversion index: 0  | Data type: Uint16                      | Change during operation: True |

**N O T I C E**

This parameter is only available with software version 48.XX.

Enter a value to specify the ramp speed reference. When 0 is specified, the ramp speed is selected based on the settings in *parameter 1-23 Motor Frequency* for induction motors and *parameter 1-25 Motor Nominal Speed* for synchronous motors. When a value greater than 0 is specified, the ramp speed reference is used to accelerate or decelerate irrespectively of motor type or data.

Parameter 3-33 Sync Mode & Start Behavior

Table 215: Parameter 3-33 Sync Mode & Start Behavior

| 3-33 Sync Mode & Start Behavior  |                        |                          |
|----------------------------------|------------------------|--------------------------|
| Default value: [0] Relative Sync | Parameter type: Option | Setup:                   |
| Conversion index: -              | Data type: Uint8       | Change during operation: |

**NOTICE**

This parameter is only available with software version 48.XX.

Select the type of synchronization and start mechanism for synchronization mode. Marker synchronization is enabled when options [10] *Marker Shortest*, [11] *Marker Catch Up*, or [12] *Marker Slow Down* is selected.

| Option | Name                | Description   |
|--------|---------------------|---|
| [0]*   | Relative Sync.      | The follower position is locked to the master position at start, then Enable Reference is active.   |
| [1]    | Relative Re-Sync.   | The position of the follower drive stays locked to the master drive's position when Enable Reference is active, though the drive is stopped or coasted. For example, when the drive is restarted after an alarm, the follower drive realigns with the master drive.   |
| [2]    | Absolute Sync.      | The position of the follower drive is always locked to the position of the master drive.  |
| [10]   | Marker Shortest     | Controls the behavior of the 1 <sup>st</sup> marker synchronization. Marker synchronization start-up behavior depends on <i>parameter 3-34 Marker Distance</i> : <ul style="list-style-type: none"> <li>When <i>parameter 3-34 Marker Distance</i> = 0 (OFF), the 1<sup>st</sup> follower marker is aligned with the 1<sup>st</sup> master marker.</li> <li>When <i>parameter 3-34 Marker Distance</i> &gt; 0, the 1<sup>st</sup> follower marker is aligned with the closest master marker to accelerate or decelerate to the correct position by a maximum of half the marker distance.</li> </ul>  |
| [11]   | Marker Catch Up     | Select this option to accelerate the follower to reach the position of the previous master marker during marker synchronization.  |
| [12]   | Marker Slow Down    | Select this option to decelerate the follower to align with the subsequent master marker during marker synchronization.   |
| [13]   | Mar. Dis. Meas. Fo. | Select this option to measure the follower marker distance while synchronizing without marker correction, when the master is running. The measured follower marker distance is set in <i>parameter 3-34 Marker Distance</i> .   |
| [14]   | Mar. Dis. Meas. Ma. | Select this option to measure master marker distance while synchronizing without marker correction, when the master is running. The measured master marker distance is set in <i>parameter 3-34 Marker Distance</i> .   |
| [15]   | Mar. meas. shortest | Continuous measurement of distance between master and follower marker where the behavior depends on <i>parameter 3-34 Marker Distance</i> . <ul style="list-style-type: none"> <li><i>Parameter 3-34 Marker Distance</i> = 0 (OFF): Distance is measure between the 1<sup>st</sup> follower marker and the 1<sup>st</sup> master marker no matter which one comes first, this is considered as the 1<sup>st</sup> pair of markers. Distance will then be measured between every following pairs of master and follower markers.</li> <li><i>Parameter 3-34 Marker Distance</i> &gt; 0: At every follower marker distance is measured to the closest master marker.</li> </ul> The result of the measurement is updated in <i>parameter 18-24 Marker Pos. Offset</i> in position units as defined in <i>parameter group 17-0* Position Scaling</i> . |

| Option | Name                 | Description  |
|--------|----------------------|--|
| [16]   | Mar. meas. catch up  | Continuous measurement of distance between master and follower marker. At every follower marker the distance is measured to the latest master marker. The result of the measurement is updated in <i>parameter 18-24 Marker Pos.</i> Offset in position units as defined in <i>parameter group 17-0* Position Scaling.</i> |
| [17]   | Mar. meas. slow down | Continuous measurement of distance between master and follower marker. At every master marker the distance is measured to the latest follower maker. The result of the measurement is updated in <i>parameter 18-24 Marker Po.</i> Offset in position units as defined in <i>parameter group 17-0* Position Scaling.</i>   |
| [20]   | CAM                  | Synchronizing according to the profile defined by <i>parameter 3-36 CAM Master Table</i> and <i>parameter 3-37 CAM Follower Table.</i>   |
| [21]   | CAM offset           | Synchronizing according to the profile defined by <i>parameter 3-36 CAM Master Table</i> and <i>parameter 3-37 CAM Follower Table</i> with master offset defined in <i>parameter 3-26 Master Offset.</i>   |

Parameter 3-34 Marker Distance

Table 216: Parameter 3-34 Marker Distance

| 3-34 Marker Distance                |  |                          |
|-------------------------------------|--|--------------------------|
| Default value: 0 CustomReadoutUnit2 | Parameter type: Range, 0 - 2147483647 CustomReadoutUnit2 | Setup:                   |
| Conversion index: 0                 | Data type: Int32   | Change during operation: |

**NOTICE**

This parameter is only available with software version 48.XX.

Enter the approximate distance between 2 markers. To measure the marker distance for follower or master marker, select the corresponding marker measuring function in *parameter 3-33 Sync. Mode & Start Behavior*. Marker distance is in position units as defined in *parameter group 17-1\* Position Scaling*. The value is converted to the position units of the follower using the master scale set in *parameter 3-22 Master Scale Numerator* and *parameter 3-23 Master Scale Denominator*. Configure the marker distance to utilize the marker window function.

Parameter 3-35 Marker Window

Table 217: Parameter 3-35 Marker Window

| 3-35 Marker Window                  |   |                          |
|-------------------------------------|---|--------------------------|
| Default value: 0 CustomReadoutUnit2 | Parameter type: Range, 0 - par. 3-34 CustomReadoutUnit2 | Setup:                   |
| Conversion index: 0                 | Data type: Int32  | Change during operation: |

**NOTICE**

This parameter is only available with software version 48.XX.

Make sure to configure *parameter 3-34 Marker Distance*. The marker window function is only active when the marker distance is set. Enter the window size around the expected marker position where the marker is accepted. The marker window is used for both master and follower marker and the position units are as defined in *parameter group 17-7\* Position Scaling*. Master position value is converted to follower position units using the master scale set in *parameter 3-22 Master Scale Numerator* and *parameter 3-23 Master Scale Denominator*.

Parameter 3-36 CAM Master Table

Table 218: Parameter 3-36 CAM Master Table

| 3-36 CAM Master Table |   |                               |
|-----------------------|---|-------------------------------|
| Default value: 0      | Parameter type: Range, -2147483648 - 2147483647 | Setup: All setups             |
| Conversion index: 0   | Data type: Int32, Array [20]                    | Change during operation: True |

**NOTICE**

This parameter is only available with software version 48.XX.

Master position which together with the corresponding element of *parameter 3-37 CAM Follower Table* forms a CAM position point.

Table 219: Parameter 3-37 CAM Follower Table

| 3-37 CAM Follower Table |  |                               |
|-------------------------|--|-------------------------------|
| Default value: 0        | Parameter type: Range, -2147483648 - 2147483647 [AbsolutePositionUnit] | Setup: All setups             |
| Conversion index: 0     | Data type: Int32, Array [20]   | Change during operation: True |

**NOTICE**

This parameter is only available with software version 48.XX.

Follower position which together with the corresponding element of *parameter 3-36 CAM Master Table* forms a CAM position point.

Table 220: Parameter 3-38 CAM Curve Table

| 3-38 CAM Curve Table    |                              |                               |
|-------------------------|------------------------------|-------------------------------|
| Default value: [0] None | Parameter type: Option       | Setup: All setups             |
| Conversion index: 0     | Data type: Uint8, Array [20] | Change during operation: True |

**NOTICE**

This parameter is only available with software version 48.XX.

| Option | Name         | Description   |
|--------|--------------|---|
| [0]*   | None         |   |
| [1]    | Linear       | Connects the CAM table point with a straight line, corresponds to a fixed gear ratio between master and follower.   |
| [2]    | Poly x'order | Connects the CAM table points with an x-order polynomial where x is determined by the number of consecutive points of this type.                                |
| [3]    | Poly 2'order | Connects the CAM table points with a 2 <sup>nd</sup> order polynomial.  |
| [4]    | Poly 3'order | Connects the CAM table points with a 3 <sup>rd</sup> order polynomial.  |
| [5]    | Poly 4'order | Connects the CAM table points with a 4 <sup>th</sup> order polynomial. At least 2 consecutive CAM table points of this type are required to use this selection. |

| Option | Name                       | Description   |
|--------|----------------------------|---|
| [6]    | Poly 5 <sup>th</sup> order | Connects the CAM table points with a 5 <sup>th</sup> order polynomial. At least 3 consecutive CAM table points of this type are required to use this selection. |
| [8]    | Sine                       | Connects the CAM table points with a full sine wave.  |
| [9]    | Cosine                     | Connects the CAM table points with a full cosine wave.  |
| [10]   | End                        | Always select this option for the last point of the curve.  |

Parameter 3-39 CAM Follower Gain

Table 221: Parameter 3-39 CAM Follower Gain

| 3-39 CAM Follower Gain |                                     |                               |
|------------------------|-------------------------------------|-------------------------------|
| Default value: 100.0   | Parameter type: Range, 0.0 - 500.0% | Setup: All setups             |
| Conversion index: -1   | Data type: Uint16                   | Change during operation: True |

**NOTICE**

This parameter is only available with software version 48.XX.

The follower table is multiplied by this gain which can be adjusted while running.

### 5.4.5 3-4\* Ramp 1

For each of the 4 ramps (*parameter groups 3-4\* Ramp 1, 3-5\* Ramp 2, 3-6\* Ramp 3, and 3-7\* Ramp 4*) configure the ramp parameters:

- Ramp type
- Ramping times (duration of acceleration and deceleration)
- Level of jerk compensation for S-ramps

Start by setting the linear ramping times corresponding to [Illustration 51](#) and [Illustration 52](#).

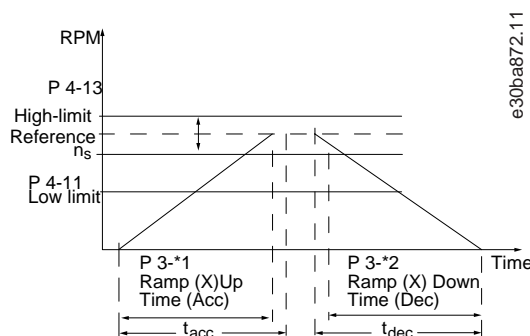

Illustration 51: Linear Ramping Times

If S-ramps are selected, set the level of non-linear jerk compensation required. Set jerk compensation by defining the proportion of ramp-up and ramp-down times where acceleration and deceleration are variable (that is, increasing or decreasing). The S-ramp acceleration and deceleration settings are defined as a percentage of the actual ramp time.

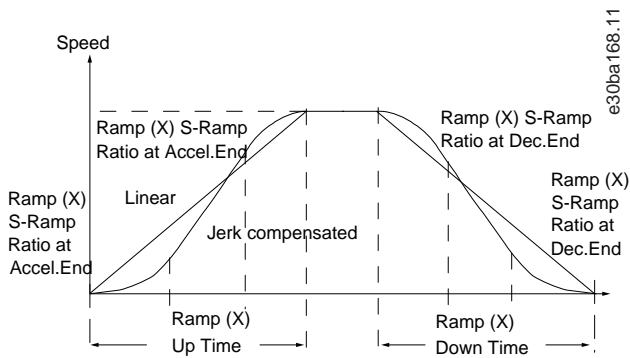

Illustration 52: Non-linear Ramping Times

Parameter 3-40 Ramp 1 Type

Table 222: Parameter 3-40 Ramp 1 Type

| 3-40 Ramp 1 Type          |                        |                               |
|---------------------------|------------------------|-------------------------------|
| Default value: [1] Linear | Parameter type: Option | Setup: All setups             |
| Conversion index: -       | Data type: Uint8       | Change during operation: True |

**NOTICE**

If [1] S-ramp Const Jerk is selected and the reference during ramping is changed, the ramp time may be prolonged to realize a jerk-free movement, which may result in a longer start or stop time. Extra adjustment of the S-ramp ratios or switching initiators may be necessary.

Select the ramp type, depending on requirements for acceleration/deceleration. A linear ramp gives constant acceleration during ramping. An S-ramp gives non-linear acceleration, compensating for jerk in the application.

| Option | Name              | Description   |
|--------|-------------------|---|
| [0]*   | Linear            |   |
| [1]    | S-ramp Const Jerk | Acceleration with lowest possible jerk.   |
| [2]    | S-ramp Const Time | S-ramp based on the values set in <i>parameter 3-41 Ramp 1 Ramp Up Time</i> and <i>parameter 3-42 Ramp 1 Ramp Down Time</i> . |

Parameter 3-41 Ramp 1 Ramp Up Time

Table 223: Parameter 3-41 Ramp 1 Ramp Up Time

| 3-41 Ramp 1 Ramp Up Time    |                                      |                               |
|-----------------------------|--------------------------------------|-------------------------------|
| Default value: Size related | Parameter type: Range, 0.01 - 3600 s | Setup: All setups             |
| Conversion index: -2        | Data type: Uint32                    | Change during operation: True |

Enter the ramp-up time, that is the acceleration time from 0 RPM to the synchronous motor speed  $n_s$ . Select a ramp-up time which prevents the output current from exceeding the current limit in *parameter 4-18 Current Limit during ramping*. The value 0.00 corresponds to 0.01 s in speed mode. See ramp-down time in *parameter 3-42 Ramp 1 Ramp Down Time*.

$$\text{Par. 3-41} = \frac{t_{acc}[s] \times n_s[\text{RPM}]}{\text{ref}[\text{RPM}]}$$

## Parameter 3-42 Ramp 1 Ramp Down Time

Table 224: Parameter 3-42 Ramp 1 Ramp Down Time

| 3-42 Ramp 1 Ramp Down Time  |                                      |                               |
|-----------------------------|--------------------------------------|-------------------------------|
| Default value: Size related | Parameter type: Range, 0.01 - 3600 s | Setup: All setups             |
| Conversion index: -2        | Data type: Uint32                    | Change during operation: True |

Enter the ramp-down time, that is the deceleration time from the synchronous motor speed  $n_s$  to 0 RPM. Select a ramp-down time such that no overvoltage occurs in the inverter due to regenerative operation of the motor, and such that the generated current does not exceed the current limit set in *parameter 4-18 Current Limit*. The value 0.00 corresponds to 0.01 s in speed mode. See ramp-up time in *parameter 3-41 Ramp 1 Ramp Up Time*.

$$\text{Par. 3-42} = \frac{t_{\text{dec}} [s] \times n_s [\text{RPM}]}{\text{ref} [\text{RPM}]}$$

## Parameter 3-45 Ramp 1 S-ramp Ratio at Accel. Start

Table 225: Parameter 3-45 Ramp 1 S-ramp Ratio at Accel. Start

| 3-45 Ramp 1 S-ramp Ratio at Accel. Start |                                |                               |
|--|--------------------------------|-------------------------------|
| Default value: 50%                       | Parameter type: Range, 1 - 99% | Setup: All setups             |
| Conversion index: 0                      | Data type: Uint8               | Change during operation: True |

Enter the proportion of the total ramp-up time (*parameter 3-41 Ramp 1 Ramp Up Time*) in which the acceleration torque increases. The larger the percentage value, the greater the jerk compensation achieved, and thus the lower the torque jerks occurring in the application.

## Parameter 3-46 Ramp 1 S-ramp Ratio Accel. End

Table 226: Parameter 3-46 Ramp 1 S-ramp Ratio at Accel. End

| 3-46 Ramp 1 S-ramp Ratio at Accel. End |                                |                               |
|--|--------------------------------|-------------------------------|
| Default value: 50%                     | Parameter type: Range, 1 - 99% | Setup: All setups             |
| Conversion index: 0                    | Data type: Uint8               | Change during operation: True |

Enter the proportion of the total ramp-up time (*parameter 3-41 Ramp 1 Ramp Up Time*) in which the acceleration torque decreases. The larger the percentage value, the greater the jerk compensation achieved, and thus the lower the torque jerks in the application.

## Parameter 3-47 Ramp 1 S-ramp Ratio at Decel. Start

Table 227: Parameter 3-47 Ramp 1 S-ramp Ratio at Decel. Start

| 3-47 Ramp 1 S-ramp Ratio at Decel. Start |                                |                               |
|--|--------------------------------|-------------------------------|
| Default value: 50%                       | Parameter type: Range, 1 - 99% | Setup: All setups             |
| Conversion index: 0                      | Data type: Uint8               | Change during operation: True |

Enter the proportion of the total ramp-down time (*parameter 3-42 Ramp 1 Ramp Down Time*) where the deceleration torque increases. The larger the percentage value, the greater the jerk compensation achieved, and thus the lower the torque jerks in the application.

## Parameter 3-48 Ramp 1 S-ramp Ratio at Decel. End

Table 228: Parameter 3-48 Ramp 1 S-ramp Ratio at Decel. End

| 3-48 Ramp 1 S-ramp Ratio at Decel. End |                                |                               |
|--|--------------------------------|-------------------------------|
| Default value: 50%                     | Parameter type: Range, 1 - 99% | Setup: All setups             |
| Conversion index: 0                    | Data type: Uint8               | Change during operation: True |



Enter the proportion of the total ramp-down time (*parameter 3-42 Ramp 1 Ramp Down Time*) where the deceleration torque decreases. The larger the percentage value, the greater the jerk compensation achieved, and thus the lower the torque jerks in the application.

### 5.4.6 3-5\* Ramp 2

#### Parameter 3-50 Ramp 2 Type

Table 229: Parameter 3-50 Ramp 2 Type

| 3-50 Ramp 2 Type          |                        |                               |
|---------------------------|------------------------|-------------------------------|
| Default value: [1] Linear | Parameter type: Option | Setup: All setups             |
| Conversion index: –       | Data type: Uint8       | Change during operation: True |

## NOTICE

If [1] *S-ramp Const Jerk* is selected and the reference during ramping is changed, the ramp time may be prolonged to realize a jerk-free movement, which may result in a longer start or stop time. Additional adjustment of the S-ramp ratios or switching initiators may be necessary.

Select the ramp type, depending on requirements for acceleration/deceleration. A linear ramp gives constant acceleration during ramping. An S-ramp gives non-linear acceleration, compensating for jerk in the application.

| Option | Name              | Description   |
|--------|-------------------|---|
| [0]*   | Linear            |   |
| [1]    | S-ramp Const Jerk | Acceleration with lowest possible jerk.   |
| [2]    | S-ramp Const Time | S-ramp based on the values set in <i>parameter 3-51 Ramp 2 Ramp Up Time</i> and <i>parameter 3-52 Ramp 2 Ramp Down Time</i> . |

#### Parameter 3-51 Ramp 2 Ramp Up Time

Table 230: Parameter 3-51 Ramp 2 Ramp Up Time

| 3-51 Ramp 2 Ramp Up Time    |                                      |                               |
|-----------------------------|--------------------------------------|-------------------------------|
| Default value: Size related | Parameter type: Range, 0.01 - 3600 s | Setup: All setups             |
| Conversion index: -2        | Data type: Uint32                    | Change during operation: True |

Enter the ramp-up time, that is the acceleration time from 0 RPM to the nominal motor speed  $n_s$ . Select a ramp-up time such that the output current does not exceed the current limit in *parameter 4-18 Current Limit* during ramping. The value 0.00 corresponds to 0.01 s in speed mode. See ramp-down time in *parameter 3-52 Ramp 2 Ramp Down Time*.

$$\text{Par. 3-51} = \frac{t_{\text{acc}}[\text{s}] \times n_s[\text{RPM}]}{\text{ref}[\text{RPM}]}$$

#### Parameter 3-52 Ramp 2 Ramp Down Time

Table 231: Parameter 3-52 Ramp 2 Ramp Down Time

| 3-52 Ramp 2 Ramp Down Time  |                                      |                               |
|-----------------------------|--------------------------------------|-------------------------------|
| Default value: Size related | Parameter type: Range, 0.01 - 3600 s | Setup: All setups             |
| Conversion index: -2        | Data type: Uint32                    | Change during operation: True |

Enter the ramp-down time, that is the deceleration time from the nominal motor speed  $n_s$  to 0 RPM. Select a ramp-down time such that no overvoltage occurs in the drive due to regenerative operation of the motor, and such that the generated current does not exceed the current limit set in *parameter 4-18 Current Limit*. The value 0.00 corresponds to 0.01 s in speed mode. See ramp-up time in *parameter 3-51 Ramp 2 Ramp Up Time*.

$$\text{Par. 3-52} = \frac{t_{\text{dec}} [\text{s}] \times n_s [\text{RPM}]}{\text{ref} [\text{RPM}]}$$

Parameter 3-55 Ramp 2 S-ramp Ratio at Accel. Start

Table 232: Parameter 3-55 Ramp 2 S-ramp Ratio at Accel. Start

| 3-55 Ramp 2 S-ramp Ratio at Accel. Start |                                |                               |
|--|--------------------------------|-------------------------------|
| Default value: 50%                       | Parameter type: Range, 1 - 99% | Setup: All setups             |
| Conversion index: 0                      | Data type: Uint8               | Change during operation: True |

Enter the proportion of the total ramp-up time (*parameter 3-51 Ramp 2 Ramp Up Time*) in which the acceleration torque increases. The larger the percentage value, the greater the jerk compensation achieved, and thus the lower the torque jerks occurring in the application.

Parameter 3-56 Ramp 2 S-ramp Ratio at Accel. End

Table 233: Parameter 3-56 Ramp 2 S-ramp Ratio at Accel. End

| 3-56 Ramp 2 S-ramp Ratio at Accel. End |                                |                               |
|--|--------------------------------|-------------------------------|
| Default value: 50%                     | Parameter type: Range, 1 - 99% | Setup: All setups             |
| Conversion index: 0                    | Data type: Uint8               | Change during operation: True |

Enter the proportion of the total ramp-up time (*parameter 3-51 Ramp 2 Ramp Up Time*) in which the acceleration torque decreases. The larger the percentage value, the greater the jerk compensation achieved, and thus the lower the torque jerks in the application.

Parameter 3-57 Ramp 2 S-ramp Ratio Decel. Start

Table 234: Parameter 3-57 Ramp 2 S-ramp Ratio at Decel. Start

| 3-57 Ramp 2 S-ramp Ratio at Decel. Start |                                |                               |
|--|--------------------------------|-------------------------------|
| Default value: 50%                       | Parameter type: Range, 1 - 99% | Setup: All setups             |
| Conversion index: 0                      | Data type: Uint8               | Change during operation: True |

Enter the proportion of the total ramp-down time (*parameter 3-52 Ramp 1 Ramp Down Time*) where the deceleration torque increases. The larger the percentage value, the greater the jerk compensation achieved, and thus the lower the torque jerks in the application.

Parameter 3-58 Ramp 2 S-ramp Ratio at Decel. End

Table 235: Parameter 3-58 Ramp 2 S-ramp Ratio at Decel. End

| 3-58 Ramp 2 S-ramp Ratio at Decel. End |                                |                               |
|--|--------------------------------|-------------------------------|
| Default value: 50%                     | Parameter type: Range, 1 - 99% | Setup: All setups             |
| Conversion index: 0                    | Data type: Uint8               | Change during operation: True |

Enter the proportion of the total ramp-down time (*parameter 3-52 Ramp 2 Ramp Down Time*) where the deceleration torque decreases. The larger the percentage value, the greater the jerk compensation achieved, and thus the lower the torque jerks in the application.

### 5.4.7 3-6\* Ramp 3

Parameter 3-60 Ramp 3 Type

Table 236: Parameter 3-60 Ramp 3 Type

| 3-60 Ramp 3 Type          |                        |                               |
|---------------------------|------------------------|-------------------------------|
| Default value: [1] Linear | Parameter type: Option | Setup: All setups             |
| Conversion index: -       | Data type: Uint8       | Change during operation: True |

## NOTICE

If [1] *S-ramp Const Jerk* is selected and the reference during ramping is changed, the ramp time may be prolonged to realize a jerk-free movement, which may result in a longer start or stop time. Additional adjustment of the S-ramp ratios or switching initiators may be necessary.

Select the ramp type, depending on requirements for acceleration/deceleration. A linear ramp gives constant acceleration during ramping. An S-ramp gives non-linear acceleration, compensating for jerk in the application.

| Option | Name              | Description   |
|--------|-------------------|---|
| [0]*   | Linear            |   |
| [1]    | S-ramp Const Jerk | Acceleration with lowest possible jerk.   |
| [2]    | S-ramp Const Time | S-ramp based on the values set in <i>parameter 3-61 Ramp 3 Ramp Up Time</i> and <i>parameter 3-62 Ramp 3 Ramp Down Time</i> . |

### Parameter 3-61 Ramp 3 Ramp Up Time

Table 237: Parameter 3-61 Ramp 3 Ramp Up Time

| 3-61 Ramp 3 Ramp Up Time    |                                      |                               |
|-----------------------------|--------------------------------------|-------------------------------|
| Default value: Size related | Parameter type: Range, 0.01 - 3600 s | Setup: All setups             |
| Conversion index: -2        | Data type: Uint32                    | Change during operation: True |

Enter the ramp-up time, that is the acceleration time from 0 RPM to the nominal motor speed  $n_s$ . Select a ramp-up time such that the output current does not exceed the current limit in *parameter 4-18 Current Limit* during ramping. The value 0.00 corresponds to 0.01 s in speed mode. See ramp-down time in *parameter 3-62 Ramp 3 Ramp Down Time*.

$$\text{Par. 3-61} = \frac{t_{\text{acc}}[\text{s}] \times n_s[\text{RPM}]}{\text{ref}[\text{RPM}]}$$

### Parameter 3-62 Ramp 3 Ramp Down Time

Table 238: Parameter 3-62 Ramp 3 Ramp Down Time

| 3-62 Ramp 3 Ramp Down Time  |                                      |                               |
|-----------------------------|--------------------------------------|-------------------------------|
| Default value: Size related | Parameter type: Range, 0.01 - 3600 s | Setup: All setups             |
| Conversion index: -2        | Data type: Uint32                    | Change during operation: True |

Enter the ramp-down time, that is the deceleration time from the nominal motor speed  $n_s$  to 0 RPM. Select a ramp-down time such that no overvoltage occurs in the drive due to regenerative operation of the motor, and such that the generated current does not exceed the current limit set in *parameter 4-18 Current Limit*. The value 0.00 corresponds to 0.01 s in speed mode. See ramp-up time in *parameter 3-61 Ramp 3 Ramp Up Time*.

$$\text{Par. 3-62} = \frac{t_{\text{dec}}[\text{s}] \times n_s[\text{RPM}]}{\text{ref}[\text{RPM}]}$$

### Parameter 3-65 Ramp 3 S-ramp Ratio at Accel. Start

Table 239: Parameter 3-65 Ramp 3 S-ramp Ratio at Accel. Start

| 3-65 Ramp 3 S-ramp Ratio at Accel. Start |                                |                               |
|--|--------------------------------|-------------------------------|
| Default value: 50%                       | Parameter type: Range, 1 - 99% | Setup: All setups             |
| Conversion index: 0                      | Data type: Uint8               | Change during operation: True |

Enter the proportion of the total ramp-up time (*parameter 3-61 Ramp 3 Ramp Up Time*) in which the acceleration torque increases. The larger the percentage value, the greater the jerk compensation achieved, and thus the lower the torque jerks occurring in the application.

Parameter 3-66 Ramp 3 S-ramp Ratio at Accel. End

Table 240: Parameter 3-66 Ramp 3 S-ramp Ratio at Accel. End

| 3-66 Ramp 3 S-ramp Ratio at Accel. End |                                |                               |
|--|--------------------------------|-------------------------------|
| Default value: 50%                     | Parameter type: Range, 1 - 99% | Setup: All setups             |
| Conversion index: 0                    | Data type: Uint8               | Change during operation: True |

Enter the proportion of the total ramp-up time (*parameter 3-61 Ramp 3 Ramp Up Time*) in which the acceleration torque decreases. The larger the percentage value, the greater the jerk compensation achieved, and thus the lower the torque jerks in the application. Parameter 3-67 Ramp 3 S-ramp Ratio at Decel. Start

Table 241: Parameter 3-67 Ramp 3 S-ramp Ratio at Decel. Start

| 3-67 Ramp 3 S-ramp Ratio at Decel. Start |                                |                               |
|--|--------------------------------|-------------------------------|
| Default value: 50%                       | Parameter type: Range, 1 - 99% | Setup: All setups             |
| Conversion index: 0                      | Data type: Uint8               | Change during operation: True |

Enter the proportion of the total ramp-down time (*parameter 3-52 Ramp 1 Ramp Down Time*) where the deceleration torque increases. The larger the percentage value, the greater the jerk compensation achieved, and thus the lower the torque jerks in the application. Parameter 3-68 Ramp 3 S-ramp Ratio at Decel. End

Parameter 3-68 Ramp 3 S-ramp Ratio at Decel. End

Table 242: Parameter 3-68 Ramp 3 S-ramp Ratio at Decel. End

| 3-68 Ramp 3 S-ramp Ratio at Decel. End |                                |                               |
|--|--------------------------------|-------------------------------|
| Default value: 50%                     | Parameter type: Range, 1 - 99% | Setup: All setups             |
| Conversion index: 0                    | Data type: Uint8               | Change during operation: True |

Enter the proportion of the total ramp-down time (*parameter 3-62 Ramp 3 Ramp Down Time*) where the deceleration torque decreases. The larger the percentage value, the greater the jerk compensation achieved, and thus the lower the torque jerks in the application.

### 5.4.8 3-7\* Ramp 4

Parameter 3-70 Ramp 4 Type

Table 243: Parameter 3-70 Ramp 4 Type

| 3-70 Ramp 4 Type          |                        |                               |
|---------------------------|------------------------|-------------------------------|
| Default value: [1] Linear | Parameter type: Option | Setup: All setups             |
| Conversion index: –       | Data type: Uint8       | Change during operation: True |

## NOTICE

If [1] *S-ramp Const Jerk* is selected and the reference during ramping is changed, the ramp time may be prolonged to realize a jerk-free movement, which may result in a longer start or stop time. Additional adjustment of the S-ramp ratios or switching initiators may be necessary.

Select the ramp type, depending on requirements for acceleration/deceleration. A linear ramp gives constant acceleration during ramping. An S-ramp gives non-linear acceleration, compensating for jerk in the application.

| Option | Name              | Description   |
|--------|-------------------|---|
| [0]*   | Linear            |   |
| [1]    | S-ramp Const Jerk | Acceleration with lowest possible jerk.   |
| [2]    | S-ramp Const Time | S-ramp based on the values set in <i>parameter 3-71 Ramp 4 Ramp Up Time</i> and <i>parameter 3-72 Ramp 4 Ramp Down Time</i> . |

### Parameter 3-71 Ramp 4 Ramp Up Time

Table 244: Parameter 3-71 Ramp 4 Ramp Up Time

| 3-71 Ramp 4 Ramp Up Time    |                                      |                               |
|-----------------------------|--------------------------------------|-------------------------------|
| Default value: Size related | Parameter type: Range, 0.01 - 3600 s | Setup: All setups             |
| Conversion index: -2        | Data type: Uint32                    | Change during operation: True |

Enter the ramp-up time, that is the acceleration time from 0 RPM to the nominal motor speed  $n_s$ . Select a ramp-up time such that the output current does not exceed the current limit in *parameter 4-18 Current Limit* during ramping. The value 0.00 corresponds to 0.01 s in speed mode. See ramp-down time in *parameter 3-72 Ramp 4 Ramp Down Time*.

$$\text{Par. 3-71} = \frac{t_{\text{acc}} [\text{s}] \times n_s [\text{RPM}]}{\text{ref} [\text{RPM}]}$$

### Parameter 3-72 Ramp 4 Ramp Down Time

Table 245: Parameter 3-72 Ramp 4 Ramp Down Time

| 3-72 Ramp 4 Ramp Down Time  |                                      |                               |
|-----------------------------|--------------------------------------|-------------------------------|
| Default value: Size related | Parameter type: Range, 0.01 - 3600 s | Setup: All setups             |
| Conversion index: -2        | Data type: Uint32                    | Change during operation: True |

Enter the ramp-down time, that is the deceleration time from the nominal motor speed  $n_s$  to 0 RPM. Select a ramp-down time such that no overvoltage occurs in the drive due to regenerative operation of the motor, and such that the generated current does not exceed the current limit set in *parameter 4-18 Current Limit*. The value 0.00 corresponds to 0.01 s in speed mode. See ramp-up time in *parameter 3-71 Ramp 4 Ramp Up Time*.

$$\text{Par. 3-72} = \frac{t_{\text{dec}} [\text{s}] \times n_s [\text{RPM}]}{\text{ref} [\text{RPM}]}$$

### Parameter 3-75 Ramp 4 S-ramp Ratio Accel. Start

Table 246: Parameter 3-75 Ramp 4 S-ramp Ratio at Accel. Start

| 3-75 Ramp 4 S-ramp Ratio at Accel. Start |                                |                               |
|--|--------------------------------|-------------------------------|
| Default value: 50%                       | Parameter type: Range, 1 - 99% | Setup: All setups             |
| Conversion index: 0                      | Data type: Uint8               | Change during operation: True |

Enter the proportion of the total ramp-up time (*parameter 3-71 Ramp 4 Ramp Up Time*) in which the acceleration torque increases. The larger the percentage value, the greater the jerk compensation achieved, and thus the lower the torque jerks occurring in the application.

### Parameter 3-76 Ramp 4 S-ramp Ratio at Accel. End

Table 247: Parameter 3-76 Ramp 4 S-ramp Ratio at Accel. End

| 3-76 Ramp 4 S-ramp Ratio at Accel. End |                                |                               |
|--|--------------------------------|-------------------------------|
| Default value: 50%                     | Parameter type: Range, 1 - 99% | Setup: All setups             |
| Conversion index: 0                    | Data type: Uint8               | Change during operation: True |

Enter the proportion of the total ramp-up time (*parameter 3-71 Ramp 4 Ramp Up Time*) in which the acceleration torque decreases. The larger the percentage value, the greater the jerk compensation achieved, and thus the lower the torque jerks in the application. Parameter 3-77 Ramp 4 S-ramp Ratio at Decel. Start

Table 248: Parameter 3-77 Ramp 4 S-ramp Ratio at Decel. Start

| 3-77 Ramp 4 S-ramp Ratio at Decel. Start |                                |                               |
|--|--------------------------------|-------------------------------|
| Default value: 50%                       | Parameter type: Range, 1 - 99% | Setup: All setups             |
| Conversion index: 0                      | Data type: Uint8               | Change during operation: True |

Enter the proportion of the total ramp-down time (*parameter 3-72 Ramp 4 Ramp Down Time*) where the deceleration torque increases. The larger the percentage value, the greater the jerk compensation achieved, and thus the lower the torque jerks in the application.

Parameter 3-78 Ramp 4 S-ramp Ratio at Decel. End

Table 249: Parameter 3-78 Ramp 4 S-ramp Ratio at Decel. End

| 3-78 Ramp 4 S-ramp Ratio at Decel. End |                                |                               |
|--|--------------------------------|-------------------------------|
| Default value: 50%                     | Parameter type: Range, 1 - 99% | Setup: All setups             |
| Conversion index: 0                    | Data type: Uint8               | Change during operation: True |

Enter the proportion of the total ramp-down time (*parameter 3-72 Ramp 4 Ramp Down Time*) where the deceleration torque decreases. The larger the percentage value, the greater the jerk compensation achieved, and thus the lower the torque jerks in the application.

### 5.4.9 3-8\* Other Ramps

Parameter 3-80 Jog/Homing Ramp Time

Table 250: Parameter 3-80 Jog/Homing Ramp Time

| 3-80 Jog/Homing Ramp Time   |                                      |                               |
|-----------------------------|--------------------------------------|-------------------------------|
| Default value: Size related | Parameter type: Range, 0.01 - 3600 s | Setup: All setups             |
| Conversion index: -2        | Data type: Uint32                    | Change during operation: True |

Enter the jog ramp time, that is the acceleration/deceleration time between 0 RPM and the rated motor frequency  $n_s$ . Ensure that the resulting output current required for the given jog ramp time does not exceed the current limit in *parameter 4-18 Current Limit*. The jog ramp time starts after activation of a jog signal via the LCP, a selected digital input, or the serial communication port. When jog state is disabled, then the normal ramping times are valid.

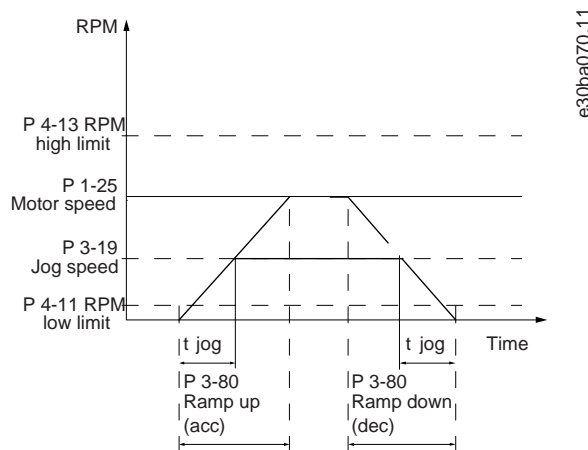

Illustration 53: Jog Ramp Time

$$\text{Par. 3-80} = \frac{t_{\text{jog}} [s] \times n_s [\text{RPM}]}{\Delta \text{jog speed (par. 3-19) [RPM]}}$$

Parameter 3-81 Quick Stop Ramp Time

Table 251: Parameter 3-81 Quick Stop Ramp Time

| 3-81 Quick Stop Ramp Time   |                                      |                               |
|-----------------------------|--------------------------------------|-------------------------------|
| Default value: Size related | Parameter type: Range, 0.01 - 3600 s | Setup: 2 setups               |
| Conversion index: -2        | Data type: Uint32                    | Change during operation: True |

Enter the quick-stop ramp-down time, that is the deceleration time from the synchronous motor speed to 0 RPM. Ensure that no resulting overvoltage occurs in the inverter due to regenerative operation of the motor required to achieve the given ramp-down time. Ensure also that the generated current required to achieve the given ramp-down time does not exceed the current limit (set in *parameter 4-18 Current Limit*). Quick stop is activated with a signal on a selected digital input, or via the serial communication port.

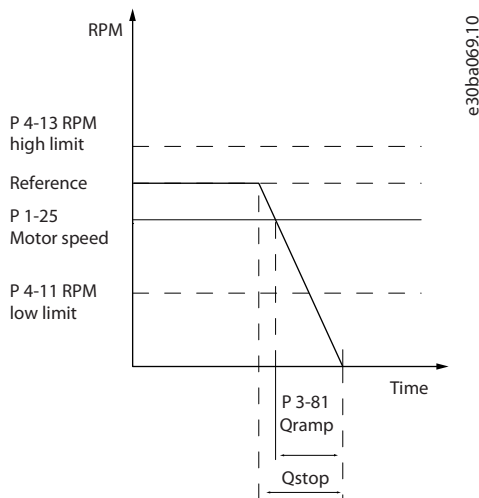

Illustration 54: Quick Stop Ramp Time

Parameter 3-82 Quick Stop Ramp Type

Table 252: Parameter 3-82 Quick Stop Ramp Type

| 3-82 Quick Stop Ramp Type |                        |                               |
|---------------------------|------------------------|-------------------------------|
| Default value: [1] Linear | Parameter type: Option | Setup: All setups             |
| Conversion index: -       | Data type: Uint8       | Change during operation: True |

Select the ramp type, depending on requirements for acceleration/deceleration. A linear ramp gives constant acceleration during ramping. An S-ramp gives non-linear acceleration, compensating for jerk in the application.

| Option | Name              | Description |
|--------|-------------------|-------------|
| [0]*   | Linear            |             |
| [1]    | S-ramp Const Jerk |             |
| [2]    | S-ramp Const Time |             |

Parameter 3-83 Quick Stop S-ramp Ratio at Decel. Start

Table 253: Parameter 3-83 Quick Stop S-ramp Ratio at Decel. Start

| 3-83 Quick Stop S-ramp Ratio at Decel. Start |                                |                               |
|--|--------------------------------|-------------------------------|
| Default value: 50%                           | Parameter type: Range, 1 - 99% | Setup: All setups             |
| Conversion index: 0                          | Data type: Uint8               | Change during operation: True |

Enter the proportion of the total ramp-up time (*parameter 3-41 Ramp 1 Ramp Up Time*) where the deceleration torque increases. The larger the percentage value, the greater the jerk compensation achieved, and thus the lower the torque jerks in the application.  
 Parameter 3-84 Quick Stop S-ramp at Decel. End

Table 254: Parameter 3-84 Quick Stop S-ramp at Decel. End

| 3-84 Quick Stop S-ramp at Decel. End |                                |                               |
|--------------------------------------|--------------------------------|-------------------------------|
| Default value: 50%                   | Parameter type: Range, 1 - 99% | Setup: All setups             |
| Conversion index: 0                  | Data type: Uint8               | Change during operation: True |

Enter the proportion of the total ramp-down time (*parameter 3-42 Ramp 1 Ramp Down Time*) where the deceleration torque decreases. The larger the percentage value, the greater the jerk compensation achieved, and thus the lower the torque jerks in the application.

Parameter 3-89 Ramp Lowpass Filter Time

Table 255: Parameter 3-89 Ramp Lowpass Filter Time

| 3-89 Ramp Lowpass Filter Time |                                    |                               |
|-------------------------------|------------------------------------|-------------------------------|
| Default value: 1 ms           | Parameter type: Range, 1 - 2000 ms | Setup: All setups             |
| Conversion index: -4          | Data type: Uint16                  | Change during operation: True |

Use this parameter to set how smoothly the speed changes.

### 5.4.10 3-9\* Digital Pot.Meter

The digital potentiometer enables increase or decrease of the actual reference by adjusting the setup of the digital inputs using the functions increase, decrease, or clear. To activate the function, set at least 1 digital input to increase or decrease.

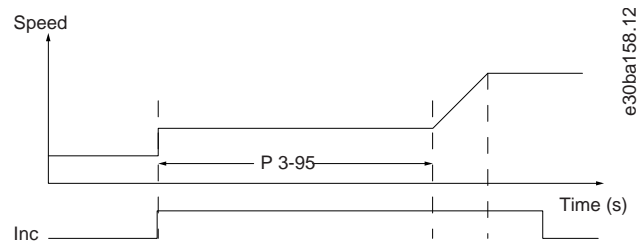

Illustration 55: Increase Actual Reference

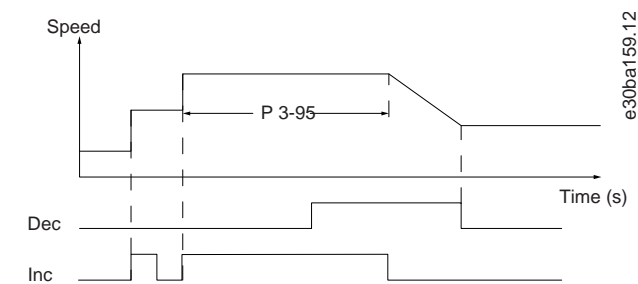

Illustration 56: Increase/Decrease Actual Reference

Parameter 3-90 Step Size

Table 256: Parameter 3-90 Step Size

| 3-90 Step Size       |                                    |                               |
|----------------------|------------------------------------|-------------------------------|
| Default value: 0.1%  | Parameter type: Range, 0.01 - 200% | Setup: All setups             |
| Conversion index: -2 | Data type: Uint16                  | Change during operation: True |



Enter the increment size required for increase/decrease as a percentage of the synchronous motor speed,  $n_s$ . If increase/decrease is activated, the resulting reference is increased or decreased by the value set in this parameter.

Parameter 3-91 Ramp Time

Table 257: Parameter 3-91 Ramp Time

| 3-91 Ramp Time       |                                   |                               |
|----------------------|-----------------------------------|-------------------------------|
| Default value: 0 s   | Parameter type: Range, 0 - 3600 s | Setup: All setups             |
| Conversion index: -2 | Data type: Uint32                 | Change during operation: True |

Enter the ramp time, that is the time for adjustment of the reference 0–100% of the specified digital potentiometer function (increase, decrease, or clear). If increase/decrease is activated for longer than the ramp delay period specified in *parameter 3-95 Ramp Delay*, the actual reference is ramped up/down according to this ramp time. The ramp time is defined as the time used to adjust the reference by the step size specified in *parameter 3-90 Step Size*.

Parameter 3-92 Power Restore

Table 258: Parameter 3-92 Power Restore

| 3-92 Power Restore     |                        |                               |
|------------------------|------------------------|-------------------------------|
| Default value: [0] Off | Parameter type: Option | Setup: All setups             |
| Conversion index: –    | Data type: Uint8       | Change during operation: True |

| Option | Name | Description   |
|--------|------|---|
| [0]*   | Off  | Resets the digital potentiometer reference to 0% after power-up.      |
| [1]    | On   | Restores the most recent digital potentiometer reference at power-up. |

Parameter 3-93 Maximum Limit

Table 259: Parameter 3-93 Maximum Limit

| 3-93 Maximum Limit  |                                    |                               |
|---------------------|------------------------------------|-------------------------------|
| Default value: 100% | Parameter type: Range, -200 - 200% | Setup: All setups             |
| Conversion index: 0 | Data type: Int16                   | Change during operation: True |

Set the maximum allowed value for the resulting reference. This is recommended if the digital potentiometer is used for fine-tuning of the resulting reference.

Parameter 3-94 Minimum Limit

Table 260: Parameter 3-94 Minimum Limit

| 3-94 Minimum Limit  |                                    |                               |
|---------------------|------------------------------------|-------------------------------|
| Default value: 100% | Parameter type: Range, -200 - 200% | Setup: All setups             |
| Conversion index: 0 | Data type: Int16                   | Change during operation: True |

Set the minimum allowed value for the resulting reference. This is recommended if the digital potentiometer is used for fine-tuning of the resulting reference.

Parameter 3-95 Ramp Delay

Table 261: Parameter 3-95 Ramp Delay

| 3-95 Ramp Delay             |                                     |                               |
|-----------------------------|-------------------------------------|-------------------------------|
| Default value: Size related | Parameter type: Range, 0 - 0        | Setup: All setups             |
| Conversion index: -3        | Data type: TimeDiff w/o Datelident. | Change during operation: True |

Enter the delay required from activation of the digital potentiometer function until the drive starts to ramp the reference. With a delay of 0 ms, the reference starts to ramp when increase/decrease is activated. See also *parameter 3-91 Ramp Time*.

## 5.5 Parameter Group 4-\*\* Limits/Warnings

### 5.5.1 4-1\* Motor Limits

Define torque, current, and speed limits for the motor, and the reaction of the drive when the limits are exceeded. A limit may generate a message in the display. A warning always generates a message in the display or on the fieldbus. A monitoring function may initiate a warning or a trip, after which the drive stops and generates an alarm message.

#### Parameter 4-10 Motor Speed Direction

Table 262: Parameter 4-10 Motor Speed Direction

| 4-10 Motor Speed Direction  |                        |                                |
|-----------------------------|------------------------|--------------------------------|
| Default value: Size related | Parameter type: Option | Setup: All setups              |
| Conversion index: –         | Data type: Uint8       | Change during operation: False |

## N O T I C E

This parameter cannot be adjusted while the motor is running.

Select the motor speed directions required. Use this parameter to prevent unwanted reversing. When *parameter 1-00 Configuration Mode* is set to [3] *Process*, *parameter 4-10 Motor Speed Direction* is set to [0] *Clockwise* as default. The setting in *parameter 4-10 Motor Speed Direction* does not limit options for setting *parameter 4-13 Motor Speed High Limit [RPM]*.

| Option | Name             | Description   |
|--------|------------------|---|
| [0]    | Clockwise        | The reference is set to CW rotation. Reversing input (default terminal 19) must be open.  |
| [1]    | Counterclockwise | The reference is set to CCW rotation. Reversing input (default terminal 19) must be closed. If reversing is required with reverse input open, the motor direction can be changed by <i>parameter 1-06 Clockwise Direction</i> . |
| [2]    | Both directions  | Allows the motor to rotate in both directions.  |

#### Parameter 4-11 Motor Speed Low Limit [RPM]

Table 263: Parameter 4-11 Motor Speed Low Limit [RPM]

| 4-11 Motor Speed Low Limit [RPM] |   |                               |
|----------------------------------|---|-------------------------------|
| Default value: Size related      | Parameter type: Range, 0 - setting in par. 4-13 RPM | Setup: All setups             |
| Conversion index: 67             | Data type: Uint16                                   | Change during operation: True |

Enter the minimum limit for motor speed. The motor speed low limit can be set to correspond to the manufacturer's recommended minimum motor speed. The motor speed low limit must not exceed the setting in *parameter 4-13 Motor Speed High Limit [RPM]*.

#### Parameter 4-12 Motor Speed Low Limit [Hz]

Table 264: Parameter 4-12 Motor Speed Low Limit [Hz]

| 4-12 Motor Speed Low Limit [Hz] |  |                               |
|---------------------------------|--|-------------------------------|
| Default value: Size related     | Parameter type: Range, 0 - setting in par. 4-14 Hz | Setup: All setups             |
| Conversion index: -1            | Data type: Uint16                                  | Change during operation: True |

Enter the minimum limit for motor speed. The motor speed low limit can be set to correspond to the minimum output frequency of the motor shaft. The motor speed low limit must not exceed the setting in *parameter 4-14 Motor Speed High Limit [Hz]*.

Parameter 4-13 Motor Speed High Limit [RPM]

Table 265: Parameter 4-13 Motor Speed High Limit [RPM]

| 4-13 Motor Speed High Limit [RPM] |   |                               |
|-----------------------------------|---|-------------------------------|
| Default value: Size related       | Parameter type: Range, Setting in par. 4-11 - 60000 RPM | Setup: All setups             |
| Conversion index: 67              | Data type: Uint16                                       | Change during operation: True |

Enter the maximum limit for motor speed. The motor speed high limit can be set to correspond to the manufacturer's maximum nominal motor speed. The motor speed high limit must exceed the setting in *parameter 4-11 Motor Speed Low Limit [RPM]*.

Parameter 4-14 Motor Speed High Limit [Hz]

Table 266: Parameter 4-14 Motor Speed High Limit [Hz]

| 4-14 Motor Speed High Limit [Hz] |  |                               |
|----------------------------------|--|-------------------------------|
| Default value: Size related      | Parameter type: Range, Setting in par. 4-12 - setting in par. 4-19 | Setup: All setups             |
| Conversion index: -1             | Data type: Uint16  | Change during operation: True |

Enter the maximum limit for motor speed in Hz. *Parameter 4-14 Motor Speed High Limit [Hz]* can be set to correspond to the manufacturer's recommended maximum motor speed. The motor speed high limit must exceed the value in *parameter 4-12 Motor Speed Low Limit [Hz]*. The output frequency must not exceed 10% of the switching frequency (*parameter 14-01 Switching Frequency*).

Parameter 4-16 Torque Limit Motor Mode

Table 267: Parameter 4-16 Torque Limit Motor Mode

| 4-16 Torque Limit Motor Mode |                                    |                               |
|------------------------------|------------------------------------|-------------------------------|
| Default value: Size related  | Parameter type: Range, 0 - 1000.0% | Setup: All setups             |
| Conversion index: -1         | Data type: Uint16                  | Change during operation: True |

**NOTICE**

If changing *parameter 4-16 Torque Limit Motor Mode* when *parameter 1-00 Configuration Mode* is set to [0] Speed open loop, *parameter 1-66 Min. Current at Low Speed* is automatically readjusted.

**NOTICE**

The torque limit reacts to the actual, non-filtered torque, including torque spikes. This is not the torque that is seen from the LCP or the fieldbus as the torque is filtered.

This function limits the torque on the shaft to protect the mechanical installation.

Parameter 4-17 Torque Limit Generator Mode

Table 268: Parameter 4-17 Torque Limit Generator Mode

| 4-17 Torque Limit Generator Mode |                                    |                               |
|----------------------------------|------------------------------------|-------------------------------|
| Default value: 100%              | Parameter type: Range, 0 - 1000.0% | Setup: All setups             |
| Conversion index: -1             | Data type: Uint16                  | Change during operation: True |

This function limits the torque on the shaft to protect the mechanical installation.

## Parameter 4-18 Current Limit

Table 269: Parameter 4-18 Current Limit

| 4-18 Current Limit          |                                      |                               |
|-----------------------------|--------------------------------------|-------------------------------|
| Default value: Size related | Parameter type: Range, 1.0 - 1000.0% | Setup: All setups             |
| Conversion index: -1        | Data type: Uint32                    | Change during operation: True |

## NOTICE

If [20] ATEX ETR is selected in *parameter 1-90 Motor Thermal Protection*, set *parameter 4-18 Current Limit* current limit to 150%.

This is a true current limit function that continues in the oversynchronous range. However, due to field weakening the motor torque at current limit will drop accordingly when the voltage increase stops above the synchronized speed of the motor.

## Parameter 4-19 Max Output Frequency

Table 270: Parameter 4-19 Max Output Frequency

| 4-19 Max Output Frequency   |                                   |                                |
|-----------------------------|-----------------------------------|--------------------------------|
| Default value: Size related | Parameter type: Range, 1 - 590 Hz | Setup: All setups              |
| Conversion index: -1        | Data type: Uint16                 | Change during operation: False |

## NOTICE

This parameter cannot be adjusted while the motor is running.

## NOTICE

Maximum output frequency cannot exceed 10% of the inverter switching frequency (*parameter 14-01 Switching Frequency*).

Provides a final limit on the output frequency for improved safety in applications where overspeeding is to be avoided. This limit is final in all configurations (independent of the setting in *parameter 1-00 Configuration Mode*).

## 5.5.2 4-2\* Limit Factors

## NOTICE

The following parameters are only available in FC 302.

- *Parameter 4-25 Power Limit Motor Factor Source*
- *Parameter 4-26 Power Limit Gener. Factor Source*

## Parameter 4-20 Torque Limit Factor Source

Table 271: Parameter 4-20 Torque Limit Factor Source

| 4-20 Torque Limit Factor Source |                        |                               |
|---------------------------------|------------------------|-------------------------------|
| Default value: [0] No function  | Parameter type: Option | Setup: All setups             |
| Conversion index: -             | Data type: Uint8       | Change during operation: True |

Select an analog input for scaling the settings in *parameter 4-16 Torque Limit Motor Mode* and *parameter 4-17 Torque Limit Generator Mode* 0–100% (or inverse). The signal levels corresponding to 0% and 100% are defined in the analog input scaling, for example *parameter group 6-1\* Analog Input 1*. This parameter is only active when *parameter 1-00 Configuration Mode* is in [0] Speed Open Loop or [1] Speed Closed Loop.

| Option | Name                 | Description |
|--------|----------------------|-------------|
| [0]*   | No function          |             |
| [2]    | Analog in 53         |             |
| [4]    | Analog in 53 inv     |             |
| [6]    | Analog in 54         |             |
| [8]    | Analog in 54 inv     |             |
| [10]   | Analog in X30-11     |             |
| [12]   | Analog in X30-11 inv |             |
| [14]   | Analog in X30-12     |             |
| [16]   | Analog in X30-12 inv |             |

## Parameter 4-21 Speed Limit Factor Source

Table 272: Parameter 4-21 Speed Limit Factor Source

| 4-21 Speed Limit Factor Source |                        |                               |
|--------------------------------|------------------------|-------------------------------|
| Default value: [0] No function | Parameter type: Option | Setup: All setups             |
| Conversion index: –            | Data type: Uint8       | Change during operation: True |

Select an analog input for scaling the settings in *parameter 4-19 Max Output Frequency* 0–100% (or the other way around). The signal levels corresponding to 0% and 100% are defined in the analog input scaling, for example *parameter group 6-1\* Analog Input 1*. This parameter is only active when *parameter 1-00 Configuration Mode* is in [4] Torque Open Loop.

| Option | Name                 | Description |
|--------|----------------------|-------------|
| [0]*   | No function          |             |
| [2]    | Analog in 53         |             |
| [4]    | Analog in 53 inv     |             |
| [6]    | Analog in 54         |             |
| [8]    | Analog in 54 inv     |             |
| [10]   | Analog in X30-11     |             |
| [12]   | Analog in X30-11 inv |             |
| [14]   | Analog in X30-12     |             |
| [16]   | Analog in X30-12 inv |             |

## Parameter 4-23 Brake Check Limit Factor Source

Table 273: Parameter 4-23 Brake Check Limit Factor Source

| 4-23 Brake Check Limit Factor Source |                        |                               |
|--------------------------------------|------------------------|-------------------------------|
| Default value: [0] DC-link Voltage   | Parameter type: Option | Setup: All setups             |
| Conversion index: –                  | Data type: Uint8       | Change during operation: True |

Select the input source for the function in *parameter 2-15 Brake Check*. If several drives are carrying out a brake check simultaneously, the resistance in the grid leads to a voltage drop on the mains or DC-link and a false brake check can occur. Use an external current sensor on every brake resistor. If an application requires a 100% valid brake check, connect the sensor to an analog input.

| Option | Name            | Description  |
|--------|-----------------|--|
| [0]*   | DC-link voltage | The drive performs the brake check by monitoring the DC-link voltage. The drive injects current in the brake resistor, which lowers the DC-link voltage. |
| [1]    | Analog input 53 | Select to use an external current sensor for brake monitoring.   |
| [2]    | Analog input 54 | Select to use an external current sensor for brake monitoring  |

#### Parameter 4-24 Brake Check Limit Factor

Table 274: Parameter 4-24 Brake Check Limit Factor

| 4-24 Brake Check Limit Factor |                                 |                               |
|-------------------------------|---------------------------------|-------------------------------|
| Default value: 98%            | Parameter type: Range, 0 - 100% | Setup: All setups             |
| Conversion index: -1          | Data type: Uint8                | Change during operation: True |

Enter the limit factor that *parameter 2-15 Brake Check* uses when performing the brake check. The drive uses the limit factor depending on the selection in *parameter 4-23 Brake Check Limit Factor Source*: [0] DC-link voltage - the drive applies the factor to the EEPROM data in the DC-link. [1] Analog Input 53 or [2] Analog Input 54 - the brake check fails if the input current on the analog input is lower than the maximum input current multiplied by the limit factor. For example, in the following configuration the brake check fails if the input current is lower than 16 mA:

- A current transducer with a range of 4-20 mA is connected to analog input 53.
- *Parameter 4-24 Brake Check Limit Factor* is set to 80%.

#### Parameter 4-25 Power Limit Motor Factor Source

Table 275: Parameter 4-25 Power Limit Motor Factor Source

| 4-25 Power Limit Motor Factor Source |                        |                               |
|--------------------------------------|------------------------|-------------------------------|
| Default value: [0] No function       | Parameter type: Option | Setup: All setups             |
| Conversion index: -                  | Data type: Uint8       | Change during operation: True |

Select the input that scales the value in *parameter 4-82 Power Limit Motor Mode* from 0% to 100%.

| Option | Name                 | Description |
|--------|----------------------|-------------|
| [0]*   | No function          |             |
| [2]    | Analog in 53         |             |
| [4]    | Analog in 53 inv     |             |
| [6]    | Analog in 54         |             |
| [8]    | Analog in 54 inv     |             |
| [10]   | Analog in X30-11     |             |
| [12]   | Analog in X30-11 inv |             |
| [14]   | Analog in X30-12     |             |
| [16]   | Analog in X30-12 inv |             |

## Parameter 4-26 Power Limit Gener. Factor Source

Table 276: Parameter 4-26 Power Limit Gener. Factor Source

| 4-26 Power Limit Gener. Factor Source |                        |                               |
|---------------------------------------|------------------------|-------------------------------|
| Default value: [0] No function        | Parameter type: Option | Setup: All setups             |
| Conversion index: –                   | Data type: Uint8       | Change during operation: True |

Select the input that scales the value in *parameter 4-83 Power Limit Generator Mode* from 0% to 100%.

| Option | Name                 | Description |
|--------|----------------------|-------------|
| [0]*   | No function          |             |
| [2]    | Analog in 53         |             |
| [4]    | Analog in 53 inv     |             |
| [6]    | Analog in 54         |             |
| [8]    | Analog in 54 inv     |             |
| [10]   | Analog in X30-11     |             |
| [12]   | Analog in X30-11 inv |             |
| [14]   | Analog in X30-12     |             |
| [16]   | Analog in X30-12 inv |             |

## 5.5.3 4-3\* Motor Feedback Monitoring

This parameter group includes monitoring and handling of motor feedback devices, such as encoders and resolvers.

## Parameter 4-30 Motor Feedback Monitoring Loss Function

Table 277: Parameter 4-30 Motor Feedback Loss Function

| 4-30 Motor Feedback Loss Function |                        |                               |
|-----------------------------------|------------------------|-------------------------------|
| Default value: Size related       | Parameter type: Option | Setup: All setups             |
| Conversion index: –               | Data type: Uint8       | Change during operation: True |

This function is used to monitor consistency in the feedback signal, that is if the feedback signal is available. Select which action the drive should take if a feedback fault is detected. The selected action is to take place when the feedback signal differs from the output speed by the value set in *parameter 4-31 Motor Feedback Speed Error* for longer than the value set in *parameter 4-32 Motor Feedback Loss Timeout*.

| Option | Name                | Description |
|--------|---------------------|-------------|
| [0]    | Disabled            |             |
| [1]    | Warning             |             |
| [2]    | Trip                |             |
| [3]    | Jog                 |             |
| [4]    | Freeze output       |             |
| [5]    | Max speed           |             |
| [6]    | Switch to open loop |             |
| [7]    | Select setup 1      |             |

| Option | Name           | Description |
|--------|----------------|-------------|
| [8]    | Select setup 2 |             |
| [9]    | Select setup 3 |             |
| [10]   | Select setup 4 |             |
| [11]   | Stop & trip    |             |

Warning 90, Feedback monitor is active as soon as the value in parameter 4-31 Motor Feedback Speed Error is exceeded, regardless of the setting in parameter 4-32 Motor Feedback Loss Timeout. Warning/Alarm 61, Feedback Error is related to the motor feedback loss function.

Parameter 4-31 Motor Feedback Speed Error

Table 278: Parameter 4-31 Motor Feedback Speed Error

| 4-31 Motor Feedback Speed Error |                                    |                               |
|---------------------------------|------------------------------------|-------------------------------|
| Default value: 300 RPM          | Parameter type: Range, 1 - 600 RPM | Setup: All setups             |
| Conversion index: 67            | Data type: Uint16                  | Change during operation: True |

Select the minimum allowed error in speed (output speed vs. feedback).

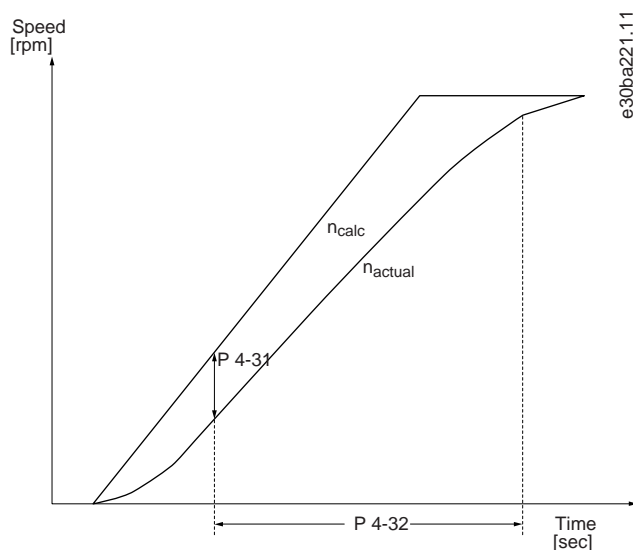

Illustration 57: Motor Feedback Speed Error

Parameter 4-32 Motor Feedback Loss Timeout

Table 279: Parameter 4-32 Motor Feedback Loss Timeout

| 4-32 Motor Feedback Loss Timeout |                                   |                               |
|----------------------------------|-----------------------------------|-------------------------------|
| Default value: Size related      | Parameter type: Range, 0 - 60 RPM | Setup: All setups             |
| Conversion index: -2             | Data type: Uint16                 | Change during operation: True |

Set the timeout value allowing the speed error set in parameter 4-31 Motor Feedback Speed Error to be exceeded before enabling the function selected in parameter 4-30 Motor Feedback Loss Function.



Parameter 4-34 Tracking Error Function

Table 280: Parameter 4-34 Tracking Error Function

| 4-34 Tracking Error Function |                        |                               |
|------------------------------|------------------------|-------------------------------|
| Default value: Size related  | Parameter type: Option | Setup: All setups             |
| Conversion index: –          | Data type: Uint8       | Change during operation: True |

This function is used to monitor that the application follows the expected speed profile. In closed loop, the speed reference to the PID is compared to the encoder feedback (filtered). In open loop, the speed reference to the PID is compensated for slip and compared to the frequency that is sent to the motor (*parameter 16-13 Frequency*). The reaction is activated if the measured difference is more than the value specified in *parameter 4-35 Tracking Error* for the time specified in *parameter 4-36 Tracking Error Timeout*. A tracking error in closed loop does not imply that there is a problem with the feedback signal. A tracking error can be the result of torque limit at too heavy loads.

| Option | Name            | Description |
|--------|-----------------|-------------|
| [0]    | Disable         |             |
| [1]    | Warning         |             |
| [2]    | Trip            |             |
| [3]    | Trip after stop |             |

*Warning/Alarm 78, Tracking Error* is related to the tracking error function.

Parameter 4-35 Tracking Error

Table 281: Parameter 4-35 Tracking Error

| 4-35 Tracking Error   |                                    |                               |
|-----------------------|------------------------------------|-------------------------------|
| Default value: 10 RPM | Parameter type: Range, 1 - 600 RPM | Setup: All setups             |
| Conversion index: 67  | Data type: Uint16                  | Change during operation: True |

Enter the maximum allowed speed error between the motor speed and the output of the ramp when not ramping. In open loop, the motor speed is estimated and in closed loop, it is the feedback from encoder/resolver.

Parameter 4-36 Tracking Error Timeout

Table 282: Parameter 4-36 Tracking Error Timeout

| 4-36 Tracking Error Timeout |                                 |                               |
|-----------------------------|---------------------------------|-------------------------------|
| Default value: 1 s          | Parameter type: Range, 0 - 60 s | Setup: All setups             |
| Conversion index: -2        | Data type: Uint16               | Change during operation: True |

Enter the timeout period during which an error greater than the value set in *parameter 4-35 Tracking Error* is allowed.

Parameter 4-37 Tracking Error Ramping

Table 283: Parameter 4-37 Tracking Error Ramping

| 4-37 Tracking Error Ramping |                                    |                               |
|-----------------------------|------------------------------------|-------------------------------|
| Default value: 100 RPM      | Parameter type: Range, 1 - 600 RPM | Setup: All setups             |
| Conversion index: 67        | Data type: Uint16                  | Change during operation: True |

Enter the maximum allowed speed error between the motor speed and the output of the ramp when ramping. In open loop, the motor speed is estimated and in closed loop, the encoder measures the speed.

Parameter 4-38 Tracking Error Ramping Timeout

Table 284: Parameter 4-38 Tracking Error Ramping Timeout

| 4-38 Tracking Error Ramping Timeout |                                 |                               |
|-------------------------------------|---------------------------------|-------------------------------|
| Default value: 1 s                  | Parameter type: Range, 0 - 60 s | Setup: All setups             |
| Conversion index: -2                | Data type: Uint16               | Change during operation: True |

Enter the timeout period during which an error greater than the value set in *parameter 4-37 Tracking Error Ramping* while ramping is allowed.

Parameter 4-39 Tracking Error After Ramping Timeout

Table 285: Parameter 4-39 Tracking Error After Ramping Timeout

| 4-39 Tracking Error After Ramping Timeout |                                 |                               |
|---|---------------------------------|-------------------------------|
| Default value: 5 s                        | Parameter type: Range, 0 - 60 s | Setup: All setups             |
| Conversion index: -2                      | Data type: Uint16               | Change during operation: True |

Enter the timeout period after ramping where *parameter 4-37 Tracking Error Ramping* and *parameter 4-38 Tracking Error Ramping Timeout* are still active.

### 5.5.4 4-4\* Speed Monitor

Parameter 4-43 Motor Speed Monitor Function

Table 286: Parameter 4-43 Motor Speed Monitor Function

| 4-43 Motor Speed Monitor Function |                        |                               |
|-----------------------------------|------------------------|-------------------------------|
| Default value: Size related       | Parameter type: Option | Setup: All setups             |
| Conversion index: -               | Data type: Uint8       | Change during operation: True |

## NOTICE

This parameter is only available in the flux control principle.

Select how the drive reacts when the motor speed monitor-function detects overspeed or wrong rotation direction. When the motor speed monitor is active, the drive detects an error if the following conditions are true for a time period specified in *parameter 4-45 Motor Speed Monitor Timeout*:

- The actual speed differs from the reference speed in *parameter 16-48 Speed Ref. After Ramp [RPM]*.
- The difference between the speeds exceeds the value in *parameter 4-44 Motor Speed Monitor Max*.

In speed closed loop, the actual speed is the feedback from the encoder measured during the time defined in *parameter 7-06 Speed PID Lowpass Filter Time*. In open loop, the actual speed is the estimated motor speed.

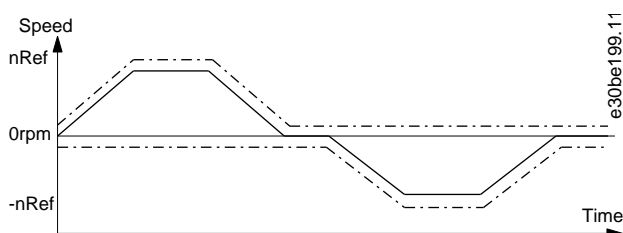

Illustration 58: Speed Reference and Maximum Allowed Speed Difference

Solid line     *Parameter 16-48 Speed Ref. After Ramp [RPM]*

Dotted line *Parameter 4-44 Motor Speed Monitor Max*

| Option | Name                | Description  |
|--------|---------------------|--|
| [0]    | Disabled            |  |
| [1]    | Warning             | The drive reports <i>warning 101, Speed monitor</i> when the speed is outside the limit.   |
| [2]    | Trip                | The drive trips and reports <i>alarm 101, Speed monitor</i> .  |
| [3]    | Jog                 |  |
| [4]    | Freeze output       |  |
| [5]    | Max speed           |  |
| [6]    | Switch to open loop |  |
| [7]    | Select setup 1      |  |
| [8]    | Select setup 2      |  |
| [9]    | Select setup 3      |  |
| [10]   | Select setup 4      |  |
| [11]   | Stop & trip         |  |
| [12]   | Trip/warning        | The drive reports <i>alarm 101, Speed monitor</i> in running mode and <i>warning 101, Speed monitor</i> in stop or coast mode. This option is only available in closed-loop operation.   |
| [13]   | Trip/catch          | Select when there is a need to catch a load, for example when mechanical braking fails. This option is available in closed loop only. The drive trips and reports <i>alarm 101, Speed monitor</i> in running mode. In stop mode, the drive catches the flying load and reports <i>warning 101, Speed monitor</i> . In catch mode, the drive applies holding torque to control the 0 speed on a potentially malfunctioning brake (closed loop). To exit this mode, send a new start signal to the drive. A coast or Safe Torque Off also terminates the function. |

Parameter 4-44 Motor Speed Monitor Max

Table 287: Parameter 4-44 Motor Speed Monitor Max

| 4-44 Motor Speed Monitor Max |                                     |                               |
|------------------------------|-------------------------------------|-------------------------------|
| Default value: 300 RPM       | Parameter type: Range, 10 - 500 RPM | Setup: All setups             |
| Conversion index: 67         | Data type: Uint16                   | Change during operation: True |

**NOTICE**

Only available in flux control principle.

Enter the maximum allowable speed deviation between the actual mechanical shaft speed and the value in *parameter 16-48 Speed Ref. After Ramp [RPM]*.

Parameter 4-45 Motor Speed Monitor Timeout

Table 288: Parameter 4-45 Motor Speed Monitor Timeout

| 4-45 Motor Speed Monitor Timeout |                                 |                               |
|----------------------------------|---------------------------------|-------------------------------|
| Default value: 0.1 s             | Parameter type: Range, 0 - 60 s | Setup: All setups             |
| Conversion index: -2             | Data type: Uint16               | Change during operation: True |

**NOTICE**

Only available in flux control principle.

Enter the timeout period during which a deviation defined in *parameter 4-44 Motor Speed Monitor Max* is allowable. The timer for this parameter is reset if the deviation stops exceeding the value in *parameter 4-44 Motor Speed Monitor Max*.

**Parameter 4-49 Motor Check Time Interval**

**Table 289: Parameter 4-49 Motor Check Time Interval**

| 4-49 Motor Check Time Interval         |                        |                               |
|--|------------------------|-------------------------------|
| Default value: [0] As fast as possible | Parameter type: Option | Setup: All setups             |
| Conversion index: -                    | Data type: Uint8       | Change during operation: True |

Select the time interval at which the connections between the motor and the drive are checked, when the motor is stopped. The motor check is performed at a specified interval, unless the motor is started in between.

| Option | Name                | Description  |
|--------|---------------------|--|
| [0]*   | As fast as possible | The motor time constant (x10) is used as the time interval to check the motor. |
| [5]    | Every 1 hour        |  |
| [10]   | Every 2 hours       |  |
| [15]   | Every 12 hours      |  |
| [20]   | Every 24 hours      |  |

### 5.5.5 4-5\* Adjustable Warnings

Use these parameters for adjusting warning limits for current, speed, reference, and feedback.

Warnings are shown on the LCP and can be programmed to be outputs or to be read out via fieldbus in the extended status word.

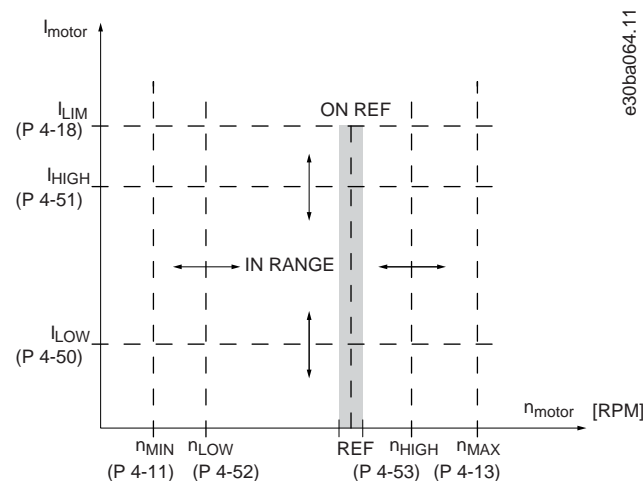

**Illustration 59: Adjustable Warnings**

#### Parameter 4-50 Warning Current Low

**Table 290: Parameter 4-50 Warning Current Low**

| 4-50 Warning Current Low |   |                               |
|--------------------------|---|-------------------------------|
| Default value: 0 A       | Parameter type: Range, 0 - setting in par. 4-51 | Setup: All setups             |
| Conversion index: -2     | Data type: Uint32                               | Change during operation: True |

Enter the  $I_{LOW}$  value. When the motor current drops below this limit, the display reads *Current Low*. The signal outputs can be programmed to produce a status signal on terminal 27 or 29 (FC 302 only) and on relay output 01 or 02 (FC 302 only). Refer to [Illustration 59](#).

Parameter 4-51 Warning Current High

Table 291: Parameter 4-51 Warning Current High

| 4-51 Warning Current High   |   |                               |
|-----------------------------|---|-------------------------------|
| Default value: Size related | Parameter type: Range, setting in par. 4-50 - setting in par. 16-37 | Setup: All setups             |
| Conversion index: -2        | Data type: Uint32   | Change during operation: True |

Enter the  $I_{HIGH}$  value. When the motor current exceeds this limit, the display reads *Current High*. The signal outputs can be programmed to produce a status signal on terminal 27 or 29 (FC 302 only) and on relay output 01 or 02 (FC 302 only). Refer to [Illustration 59](#).

Parameter 4-52 Warning Speed Low

Table 292: Parameter 4-52 Warning Speed Low

| 4-52 Warning Speed Low |   |                               |
|------------------------|---|-------------------------------|
| Default value: 0 RPM   | Parameter type: Range, 0 - setting in par. 4-53 RPM | Setup: All setups             |
| Conversion index: 67   | Data type: Uint16                                   | Change during operation: True |

Enter the  $n_{LOW}$  value. When the motor speed exceeds this limit, the display reads *Speed low*. The signal outputs can be programmed to produce a status signal on terminal 27 or 29 (FC 302 only) and on relay output 01 or 02 (FC 302 only).

Parameter 4-53 Warning Speed High

Table 293: Parameter 4-53 Warning Speed High

| 4-53 Warning Speed High     |   |                               |
|-----------------------------|---|-------------------------------|
| Default value: Size related | Parameter type: Range, setting in par. 4-52 - 60000 RPM | Setup: All setups             |
| Conversion index: 67        | Data type: Uint16                                       | Change during operation: True |

Enter the  $n_{HIGH}$  value. When the motor speed exceeds this value, the display reads *Speed high*. The signal outputs can be programmed to produce a status signal on terminals 27 or 29 (FC 302 only) and on relay outputs 01 or 02 (FC 302 only). Refer to [Illustration 59](#).

Parameter 4-54 Warning Reference Low

Table 294: Parameter 4-54 Warning Reference Low

| 4-54 Warning Reference Low |   |                               |
|----------------------------|---|-------------------------------|
| Default value: -999999.999 | Parameter type: Range, -999999.999 - setting in par. 4-55 | Setup: All setups             |
| Conversion index: -3       | Data type: Int32  | Change during operation: True |

Enter the lower reference limit. When the actual reference drops below this limit, the display indicates  $Ref_{LOW}$ . The signal outputs can be programmed to produce a status signal on terminal 27 or 29 (FC 302 only) and on relay output 01 or 02 (FC 302 only).

Parameter 4-55 Warning Reference High

Table 295: Parameter 4-55 Warning Reference High

| 4-55 Warning Reference High |  |                               |
|-----------------------------|--|-------------------------------|
| Default value: 999999.999   | Parameter type: Range, setting in par. 4-55 - 999999.999 | Setup: All setups             |
| Conversion index: -3        | Data type: Int32   | Change during operation: True |

Enter the upper reference limit. When the actual reference exceeds this limit, the display reads  $Ref_{high}$ . The signal outputs can be programmed to produce a status signal on terminal 27 or 29 (FC 302 only) and on relay output 01 or 02 (FC 302 only).

Parameter 4-56 Warning Feedback Low

Table 296: Parameter 4-56 Warning Feedback Low

| 4-56 Warning Feedback Low   |   |                               |
|-----------------------------|---|-------------------------------|
| Default value: Size related | Parameter type: Range, setting in par. 4-57 - -999999.999 ReferenceFeedbackUnit | Setup: All setups             |
| Conversion index: -3        | Data type: Int32  | Change during operation: True |

Enter the lower feedback limit. When the feedback drops below this limit, the display reads  $Feedb_{Low}$ . The signal outputs can be programmed to produce a status signal on terminal 27 or 29 (FC 302 only) and on relay output 01 or 02 (FC 302 only).

Parameter 4-57 Warning Feedback High

Table 297: Parameter 4-57 Warning Feedback High

| 4-57 Warning Feedback High  |   |                               |
|-----------------------------|---|-------------------------------|
| Default value: Size related | Parameter type: Range, par 4-56 - 999999.999 ReferenceFeedback-Unit | Setup: All setups             |
| Conversion index: -3        | Data type: Int32  | Change during operation: True |

Enter the upper feedback limit. When the feedback exceeds this limit, the display reads  $Feedb_{High}$ . The signal outputs can be programmed to produce a status signal on terminal 27 or 29 (FC 302 only) and on relay output 01 or 02 (FC 302 only).

Parameter 4-58 Missing Motor Phase Function

Table 298: Parameter 4-58 Missing Motor Phase Function

| 4-58 Missing Motor Phase Function |                        |                               |
|-----------------------------------|------------------------|-------------------------------|
| Default value: Size related       | Parameter type: Option | Setup: All setups             |
| Conversion index: -               | Data type: Uint8       | Change during operation: True |

The function detects missing motor phase while the motor is running. Shows alarms 30, 31, 32 if a motor phase is missing. Enable this function to protect the application and motor from malfunctioning if a motor phase is missing.

| Op-tion | Name                   | Description  |
|---------|------------------------|--|
| [0]     | Disabled               | The drive does not issue a missing motor phase alarm.  |
| [1]     | Trip 100 ms            | The drive performs a scan for 100 ms to detect missing motor phase. When a missing motor phase is detected, the drive trips. This selection is recommended when the motor is running at a speed of 10 Hz and above.                        |
| [2]     | Trip 1000 ms           | The drive performs a scan for 1000 ms to detect missing motor phase. When a missing motor phase is detected, the drive trips. This selection is recommended when the motor is running at a low speed of 1 Hz and above.                    |
| [3]     | Trip 100 ms 3ph detec. | <div style="text-align: center; background-color: #cccccc; padding: 5px;"><b>NOTICE</b></div> <p>Only available in FC 302 in flux closed loop. To activate for U/f and VVC+. set <i>parameter 4-59 Motor Check at Start</i> to [0] On.</p> |

| Option | Name        | Description  |
|--------|-------------|--|
|        |             | This option is relevant for applications where the motor load and motor currents are very low, such as lowering a lift. Selecting this option allows to prevent false motor phase detection due to low currents. The drive performs a scan for 100 ms to detect missing motor phases.  |
| [5]    | Motor check | <div style="text-align: center; background-color: #cccccc; padding: 5px;"><b>NOTICE</b></div> <p>This option is only available in FC 302.</p> <div style="text-align: center; background-color: #cccccc; padding: 5px;"><b>NOTICE</b></div> <p>The motor automatically resumes operation when the motor is reconnected.</p> <p>This option allows disconnection of the motor with a service switch without issuing an alarm. The drive coasts and automatically resumes operation when the motor is reconnected.</p> |

The following table details the detection of missing motor phase function for different motor control principles:

**Table 299: Missing Motor Phase for Different Motor Control Principles**

| Option | Missing motor phase function | U/f  | VVC <sup>+</sup>        | Flux open loop          | Flux closed loop  |
|--------|------------------------------|--|-------------------------|-------------------------|-------------------|
| [0]    | Disabled                     | No function  |                         |                         |                   |
| [1]    | Trip 100 ms                  | Detects missing 1 phase  | Detects missing 1 phase | Detects 1–3 phase       | Detects 1–3 phase |
| [2]    | Trip 1000 ms                 | Detects missing 1 phase  | Detects missing 1 phase | Detects missing 1 phase | N/A               |
| [3]    | Trip 100 ms 3 phase limit    | N/A <sup>(1)</sup>   |                         |                         | Detects 1–3 phase |
| [5]    | Motor check (service switch) | Coasts if motor is disconnected or auto started when the motor is reconnected. |                         |                         |                   |

<sup>1</sup> When parameter 4-59 Motor Check at Start is set to [1] On, then 3-phase detection is enabled for U/f and VVC+ motor control.

Parameter 4-59 Motor Check at Start

**Table 300: Parameter 4-59 Motor Check at Start**

| 4-59 Motor Check at Start |                        |                               |
|---------------------------|------------------------|-------------------------------|
| Default value: [0] Off    | Parameter type: Option | Setup: All setups             |
| Conversion index: –       | Data type: Uint8       | Change during operation: True |

**NOTICE**

Adjusting this parameter while the motor is running will not have effect until the next motor start.

This function detects missing motor phase before each start. Shows *alarm 30*, *alarm 31*, *alarm 32* if motor phases are missing. In these cases, the drive trips and an alarm is issued. The function has been developed to avoid disengaging a mechanical brake if motor phases are missing, for example, in lift applications.

| Option | Name | Description   |
|--------|------|---|
| [0]*   | Off  | <div style="text-align: center; background-color: #cccccc; padding: 5px;"><b>⚠ CAUTION ⚠</b></div> <p><b>RISK OF MOTOR DAMAGE</b><br/>Using this option may lead to motor damage.</p> <p>The drive does not issue a missing motor phase alarm.</p>                  |
| [1]    | On   | Before each start, the drive checks if all 3 motor phases are present. The check is performed without any shaft movement. The function also enables 3-phase detection in U/f and VVC+ mode. See description in <i>parameter 4-58 Missing Motor Phase Function</i> . |

The table details the motor check at start for different motor control principles.

**Table 301: Motor Check at Start for Different Motor Control Principles**

| Option | Motor Check at Start | U/f   | VVC <sup>+</sup> | Flux open loop | Flux closed loop |
|--------|----------------------|---|------------------|----------------|------------------|
| [0]    | Off                  | No function.  |                  |                |                  |
| [1]    | On                   | Check for missing motor phase before start is executed and enables 3-phase detection for U/f and VVC+ in <i>parameter 4-58 Missing Motor Phase Function</i> . |                  |                |                  |

### 5.5.6 4-6\* Speed Bypass

Some systems require that certain output frequencies or speeds are avoided due to resonance problems in the system. A maximum of 4 frequency or speed ranges can be avoided.

Parameter 4-60 Bypass Speed From [RPM]

**Table 302: Parameter 4-60 Bypass Speed From [RPM]**

| 4-60 Bypass Speed From [RPM] |  |                               |
|------------------------------|--|-------------------------------|
| Default value: Size related  | Parameter type: Range, 0 - setting in par. 4-13 RPM, Array [4] | Setup: All setups             |
| Conversion index: 67         | Data type: Uint16  | Change during operation: True |

Some systems call for avoiding certain output speeds due to resonance problems in the system. Enter the lower limits of the speeds to be avoided.

Parameter 4-61 Bypass Speed From [Hz]

**Table 303: Parameter 4-61 Bypass Speed From [Hz]**

| 4-61 Bypass Speed From [Hz] |   |                               |
|-----------------------------|---|-------------------------------|
| Default value: Size related | Parameter type: Range, 0 - setting in par. 4-14 Hz, Array [4] | Setup: All setups             |
| Conversion index: -1        | Data type: Uint16   | Change during operation: True |

Some systems require that certain output frequencies or speeds are avoided due to resonance problems in the system. Enter the lower limits of the speeds to be avoided.

Parameter 4-62 Bypass Speed To [RPM]

**Table 304: Parameter 4-62 Bypass Speed To [RPM]**

| 4-62 Bypass Speed To [RPM]  |  |                               |
|-----------------------------|--|-------------------------------|
| Default value: Size related | Parameter type: Range, 0 - setting in par. 4-13 RPM, Array [4] | Setup: All setups             |
| Conversion index: 67        | Data type: Uint16  | Change during operation: True |



Some systems call for avoiding certain output speeds due to resonance problems in the system. Enter the upper limits of the speeds to be avoided.

Parameter 4-63 Speed Bypass To [Hz]

Table 305: Parameter 4-63 Bypass Speed To [Hz]

| 4-63 Bypass Speed To [Hz]   |   |                               |
|-----------------------------|---|-------------------------------|
| Default value: Size related | Parameter type: Range, 0 - setting in par. 4-14 Hz, Array [4] | Setup: All setups             |
| Conversion index: -1        | Data type: Uint16   | Change during operation: True |

Some systems require that certain output frequencies or speeds are avoided due to resonance problems in the system. Enter the upper limits of the speeds to be avoided.

### 5.5.7 4-7\* Position Monitor

Parameter 4-70 Position Error Function

Table 306: Parameter 4-70 Position Error Function

| 4-70 Position Error Function |                        |                               |
|------------------------------|------------------------|-------------------------------|
| Default value: [0] Disabled  | Parameter type: Option | Setup: All setups             |
| Conversion index: -          | Data type: Uint8       | Change during operation: True |

## NOTICE

This parameter is only available with software version 48.XX.

Select the function which is activated when the position error exceeds the maximum allowed value. Position error is the difference between the actual position and the commanded position. The position error is the input for the position PI controller.

| Option | Name                | Description  |
|--------|---------------------|--|
| [0]*   | Disabled            | The drive does not monitor the position error.   |
| [1]    | Warning             | The drive issues a warning when the maximum allowed position error is exceeded. The drive continues operation. |
| [2]    | Trip                | The drive trips when the maximum allowed position error is exceeded.   |
| [3]    | Jog                 |  |
| [4]    | Freeze Output       |  |
| [5]    | Max Speed           |  |
| [6]    | Switch to Open Loop |  |
| [7]    | Select setup 1      |  |
| [8]    | Select setup 2      |  |
| [9]    | Select setup 3      |  |
| [10]   | Select setup 4      |  |
| [11]   | Stop & Trip         |  |
| [12]   | Trip/Warning        |  |
| [13]   | Trip/Catch          |  |

Parameter 4-71 Maximum Position Error

Table 307: Parameter 4-71 Maximum Position Error

| 4-71 Maximum Position Error            |   |                               |
|--|---|-------------------------------|
| Default value: 1000 CustomReadoutUnit2 | Parameter type: Range, 0 - 2147483647 Custom-ReadoutUnit2 | Setup: All setups             |
| Conversion index: 0                    | Data type: Int32  | Change during operation: True |

**NOTICE**

This parameter is only available with software version 48.XX.

Enter the maximum allowed position tracking error in position units defined in *parameter group 17-7\* Position Scaling*. If this value is exceeded during the time set in *parameter 4-72 Position Error Timeout*, the position error function in *parameter 4-70 Position Error Function* is activated.

Parameter 4-72 Position Error Timeout

Table 308: Parameter 4-72 Position Error Timeout

| 4-72 Position Error Timeout |   |                               |
|-----------------------------|---|-------------------------------|
| Default value: 0.100 s      | Parameter type: Range, 0.000 - 60.000 s | Setup: All setups             |
| Conversion index: -3        | Data type: Uint16                       | Change during operation: True |

**NOTICE**

This parameter is only available with software version 48.XX.

If the error defined in *parameter 4-71 Maximum Position Error* is present longer than the time in this parameter, the drive activates the function selected in *parameter 4-70 Position Error Function*.

Parameter 4-73 Position Limit Function

Table 309: Parameter 4-73 Position Limit Function

| 4-73 Position Limit Function           |                        |                               |
|--|------------------------|-------------------------------|
| Default value: [3] Abs. Pos. Mode Stop | Parameter type: Option | Setup: All setups             |
| Conversion index: -                    | Data type: Uint8       | Change during operation: True |

**NOTICE**

This parameter is only available with software version 48.XX.

Select the function which is activated when the position is outside the limits defined in *parameter 3-06 Minimum Position* and *parameter 3-07 Maximum Position*.

| Op-tion | Name                | Description   |
|---------|---------------------|---|
| [0]     | Disabled            | The drive does not monitor the position limits.   |
| [1]     | Warning             | The drive issues a warning when the position is outside the limits.   |
| [2]     | Warning & Trip      | The drive issues a warning when the set target is outside the position limits. The drive starts the positioning and then trips when the position limit is reached.                        |
| [3]*    | Abs. Pos. Mode Stop | The drive monitors position limits only in absolute positioning mode. The drive issues a warning and stops at the position limit when the target position is outside the position limits. |

| Option | Name                      | Description   |
|--------|---------------------------|---|
| [4]    | Abs. Pos. Md. Stop & Trip | The drive monitors position limits only in absolute positioning mode. The drive stops at the position limit and trips when the target position is outside the position limits.  |
| [5]    | Position Stop             | When the set target is outside the position limits, the drive uses the position limit as target. This option works in all modes of operation including speed and torque control. The drive issues a warning when at limit position. |
| [6]    | Position Stop & Trip      | When the set target is outside the position limits, the drive uses the position limit as target. This option works in all modes of operation including speed and torque control. The drive trips when at limit position.            |
| [7]    | Speed Stop                | When the set target is outside the position limits, the drive performs a ramp down and stops at the limit position. This option works in all modes of operation. The drive issues a warning stop.                                   |
| [8]    | Speed Stop & Trip         | When the set target is outside the position limits, the drive performs a ramp down and stops at the limit position. This option works in all modes of operation. The drive trips at stop.   |

## Parameter 4-74 Start Fwd/Rev Function

Table 310: Parameter 4-74 Start Fwd/Rev Function

| 4-74 Start Fwd/Rev Function |                        |                               |
|-----------------------------|------------------------|-------------------------------|
| Default value: [0] Stop     | Parameter type: Option | Setup: All setups             |
| Conversion index: -         | Data type: Uint8       | Change during operation: True |

## NOTICE

This parameter is only available with software version 48.XX.

Select the action that the drive executes when there is an active signal on a digital input with options [12] *Enable Start Forward* or [13] *Enable Start Reverse* selected. The drive executes the function selected in this parameter when running into an end limit switch and then the motion is only allowed in the opposite direction. When an option with trip is selected, the drive can resume motion only after reset.

| Option | Name                 | Description   |
|--------|----------------------|---|
| [0]*   | Stop                 | The drive stops the motor.  |
| [1]    | Stop & Warning       | The drive stops the motor and shows <i>warning 215, Start Fwd/Rev</i> .   |
| [2]    | Stop & Trip          | The drive stops the motor and trips with <i>alarm 215, Start Fwd/Rev</i> .  |
| [3]    | Qstop                | The drive performs the quick stop.  |
| [4]    | Qstop & Warning      | The drive performs the quick stop and shows <i>warning 215, Start Fwd/Rev</i> .   |
| [5]    | Qstop & Trip         | The drive performs the quick stop and trips with <i>alarm 215, Start Fwd/Rev</i> .  |
| [6]    | Coast                | The drive coasts the motor.   |
| [7]    | Coast & Warning      | The drive coasts the motor and trips with <i>warning 215, Start Fwd/Rev</i> .   |
| [8]    | Coast & Trip         | The drive coasts the motor and trips with <i>alarm 215, Start Fwd/Rev</i> .   |
| [9]    | Zero Speed Ref       | The drive ramps down and keeps the motor magnetized at 0 speed. In the positioning and the synchronization modes, the position controller stays active and retains the actual position. |
| [10]   | Zero Sp. Ref. & War. | Same as option [9] <i>Zero Speed Ref</i> and shows <i>warning 215, Start Fwd/Rev</i> .  |

## Parameter 4-75 Touch Timeout

Table 311: Parameter 4-75 Touch Timeout

| 4-75 Touch Timeout      |                                       |                               |
|-------------------------|---------------------------------------|-------------------------------|
| Default value: 6000.0 s | Parameter type: Range, 0.1 - 6000.0 s | Setup: All setups             |
| Conversion index: -1    | Data type: Uint16                     | Change during operation: True |

### N O T I C E

This parameter is only available with software version 48.XX.

Enter the timeout for the touch probe positioning. If the drive does not detect the touch probe sensor before the timeout when the touch probe positioning is active, the drive trips with *alarm 216, Touch Timeout*. The value 6000 equals Off.

## 5.5.8 4-8\* Power Limit

### N O T I C E

This parameter group is only available in FC 302.

## Parameter 4-80 Power Limit Func. Motor Mode

Table 312: Parameter 4-80 Power Limit Func. Motor Mode

| 4-80 Power Limit Func. Motor Mode |                        |                               |
|-----------------------------------|------------------------|-------------------------------|
| Default value: [0] Disabled       | Parameter type: Option | Setup: All setups             |
| Conversion index: –               | Data type: Uint8       | Change during operation: True |

Select whether the power limit function is enabled. Define the power limit motor mode in *parameter 4-82 Power Limit Motor Mode*.

| Option | Name           | Description                                   |
|--------|----------------|---|
| [0]*   | Disabled       |   |
| [1]    | Enabled        |   |
| [2]    | When activated | Activation via a digital input or a fieldbus. |

## Parameter 4-81 Power Limit Func. Generator Mode

Table 313: Parameter 4-81 Power Limit Func. Generator Mode

| 4-81 Power Limit Func. Generator Mode |                        |                               |
|---------------------------------------|------------------------|-------------------------------|
| Default value: [0] Disabled           | Parameter type: Option | Setup: All setups             |
| Conversion index: –                   | Data type: Uint8       | Change during operation: True |

Select whether the power limit function is enabled in generating mode. Define the power limit motor mode in *parameter 4-83 Power Limit Generator Mode*.

| Option | Name           | Description                                   |
|--------|----------------|---|
| [0]*   | Disabled       |   |
| [1]    | Enabled        |   |
| [2]    | When activated | Activation via a digital input or a fieldbus. |

Parameter 4-82 Power Limit Motor Mode

Table 314: Parameter 4-82 Power Limit Motor Mode

| 4-82 Power Limit Motor Mode |                                     |                               |
|-----------------------------|-------------------------------------|-------------------------------|
| Default value: 100.0%       | Parameter type: Range, 0.0 - 200.0% | Setup: All setups             |
| Conversion index: -1        | Data type: Uint16                   | Change during operation: True |

Enter the maximum output power when the power limit function is active. Related parameters: *parameter 1-20 Motor Power [kW]*, *parameter 1-21 Motor Power [HP]*.

Parameter 4-83 Power Limit Generator Mode

Table 315: Parameter 4-83 Power Limit Generator Mode

| 4-83 Power Limit Generator Mode |                                     |                               |
|---------------------------------|-------------------------------------|-------------------------------|
| Default value: 100.0%           | Parameter type: Range, 0.0 - 200.0% | Setup: All setups             |
| Conversion index: -1            | Data type: Uint16                   | Change during operation: True |

Enter the maximum generating power when the power limit function is active. Related parameters: *parameter 1-20 Motor Power [kW]*, *parameter 1-21 Motor Power [HP]*.

5.5.9 4-9\* Directional Limits

The directional limits functionality allows to specify different torque and speed limits for different combinations of torque application direction and rotation direction. In [Illustration 60](#), quadrants 1–4 show different combinations of rotation direction and torque application direction, and the parameters that act in different quadrants.

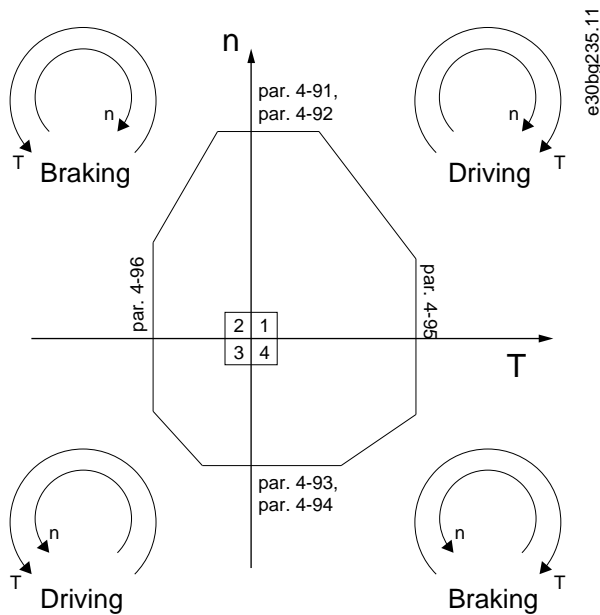

Illustration 60: Example of Directional Limits

A speed limit value cannot exceed the value of *parameter 4-13 Motor Speed High Limit [RPM]* or *parameter 4-14 Motor Speed High Limit [Hz]*. A torque limit value cannot exceed the value of *parameter 4-16 Torque Limit Motor Mode* or *parameter 4-17 Torque Limit Generator Mode*.

## Parameter 4-90 Directional Limit Mode

Table 316: Parameter 4-90 Directional Limit Mode

| 4-90 Directional Limit Mode |                        |                               |
|-----------------------------|------------------------|-------------------------------|
| Default value: [0] Disabled | Parameter type: Option | Setup: All setups             |
| Conversion index: –         | Data type: Uint8       | Change during operation: True |

Select whether the directional limits are enabled. With directional limits enabled, it is possible to specify different speed and torque limits for clockwise and counterclockwise rotation directions.

| Option | Name             | Description   |
|--------|------------------|---|
| [0]*   | Disabled         | Directional limits are disabled.                                |
| [1]    | Enabled          | Directional limits are active for the speed values.             |
| [2]    | Torque           | Directional limits are active for the torque values.            |
| [3]    | Speed and torque | Directional limits are active for both torque and speed values. |

## Parameter 4-91 Positive Speed Limit [RPM]

Table 317: Parameter 4-91 Positive Speed Limit [RPM]

| 4-91 Positive Speed Limit [RPM] |  |                               |
|---------------------------------|--|-------------------------------|
| Default value: Size related     | Parameter type: Range, 0.0 - par. 4-13 RPM | Setup: All setups             |
| Conversion index: 67            | Data type: Uint16                          | Change during operation: True |

Enter the limit for the motor speed when the rotation direction is clockwise.

## Parameter 4-92 Positive Speed Limit [Hz]

Table 318: Parameter 4-92 Positive Speed Limit [Hz]

| 4-92 Positive Speed Limit [Hz] |  |                               |
|--------------------------------|--|-------------------------------|
| Default value: Size related    | Parameter type: Range, 0.0 - par. 4-14 RPM | Setup: All setups             |
| Conversion index: -1           | Data type: Uint16                          | Change during operation: True |

Enter the limit for the motor speed when the rotation direction is clockwise.

## Parameter 4-93 Negative Speed Limit [RPM]

Table 319: Parameter 4-93 Negative Speed Limit [RPM]

| 4-93 Negative Speed Limit [RPM] |  |                               |
|---------------------------------|--|-------------------------------|
| Default value: Size related     | Parameter type: Range, 0.0 - par. 4-13 RPM | Setup: All setups             |
| Conversion index: 67            | Data type: Uint16                          | Change during operation: True |

Enter the limit for the motor speed when the rotation direction is counterclockwise.

## Parameter 4-94 Negative Speed Limit [Hz]

Table 320: Parameter 4-94 Negative Speed Limit [Hz]

| 4-94 Negative Speed Limit [Hz] |  |                               |
|--------------------------------|--|-------------------------------|
| Default value: Size related    | Parameter type: Range, 0.0 - par. 4-14 RPM | Setup: All setups             |
| Conversion index: -1           | Data type: Uint16                          | Change during operation: True |

Enter the limit for the motor speed when the rotation direction is counterclockwise.

## Parameter 4-95 Positive Torque Limit

Table 321: Parameter 4-95 Positive Torque Limit

| 4-95 Positive Torque Limit  |                                   |                               |
|-----------------------------|-----------------------------------|-------------------------------|
| Default value: Size related | Parameter type: Range, 1 - 160.0% | Setup: All setups             |
| Conversion index: -1        | Data type: Uint16                 | Change during operation: True |

Enter the limit for the motor torque when the rotation direction is clockwise.

## Parameter 4-96 Negative Torque Limit

Table 322: Parameter 4-96 Negative Torque Limit

| 4-96 Negative Torque Limit  |                                   |                               |
|-----------------------------|-----------------------------------|-------------------------------|
| Default value: Size related | Parameter type: Range, 1 - 160.0% | Setup: All setups             |
| Conversion index: -1        | Data type: Uint16                 | Change during operation: True |

Enter the limit for the motor torque when the rotation direction is counterclockwise.

## 5.6 Parameter Group 5-\*\* Digital In/Out

## 5.6.1 5-0\* Digital I/O Mode

### NOTICE

The following parameter is only available in FC 302:

- *Parameter 5-02 Terminal 29 Mode*

Parameters for configuring the input and output using NPN and PNP.

## Parameter 5-00 Digital I/O Mode

Table 323: Parameter 5-00 Digital I/O Mode

| 5-00 Digital I/O Mode  |                        |                                |
|------------------------|------------------------|--------------------------------|
| Default value: [0] PNP | Parameter type: Option | Setup: All setups              |
| Conversion index: -    | Data type: Uint8       | Change during operation: False |

### NOTICE

Perform a power cycle to activate the parameter once it has been changed.

Digital inputs and programmed digital outputs are preprogrammable for operation either in PNP or NPN systems.

| Option | Name | Description   |
|--------|------|---|
| [0]*   | PNP  | Action on positive directional pulses (↑). PNP systems are pulled down to GND.                          |
| [1]    | NPN  | Action on negative directional pulses (↓). NPN systems are pulled up to +24 V, internally in the drive. |

## Parameter 5-01 Terminal 27 Mode

Table 324: Parameter 5-01 Terminal 27 Mode

| 5-01 Terminal 27 Mode    |                        |                               |
|--------------------------|------------------------|-------------------------------|
| Default value: [0] Input | Parameter type: Option | Setup: All setups             |
| Conversion index: -      | Data type: Uint8       | Change during operation: True |

**N O T I C E**

This parameter cannot be adjusted while the motor is running.

| Option | Name   | Description                              |
|--------|--------|--|
| [0]*   | Input  | Defines terminal 27 as a digital input.  |
| [1]    | Output | Defines terminal 27 as a digital output. |

Parameter 5-02 Terminal 29 Mode

Table 325: Parameter 5-02 Terminal 29 Mode

| 5-02 Terminal 29 Mode    |                        |                               |
|--------------------------|------------------------|-------------------------------|
| Default value: [0] Input | Parameter type: Option | Setup: All setups             |
| Conversion index: –      | Data type: Uint8       | Change during operation: True |

| Option | Name   | Description                              |
|--------|--------|--|
| [0]*   | Input  | Defines terminal 29 as a digital input.  |
| [1]    | Output | Defines terminal 29 as a digital output. |

5.6.2 5-1\* Digital Inputs

**N O T I C E**

The following parameter is only available in FC 302:

- *Parameter 5-13 Terminal 29 Digital Input*

The digital inputs are used for selecting various functions in the drive. Refer to [Table 327](#) for functions which can be assigned to digital inputs.

Functions in function group 1 have higher priority than functions in function group 2.

Table 326: Function Groups

| Group | Functions  |
|-------|--|
| 1     | Reset, coast stop, reset, and coast stop, quick stop, DC brake, stop, and the [Off] key. |
| 2     | Start, latched start, reversing, start reversing, jog, and freeze output.                |

Table 327: Digital Input Functions and Terminals

| Digital input function  | Select | Terminal             |
|-------------------------|--------|----------------------|
| No operation            | [0]    | All, terminal 32, 33 |
| Reset                   | [1]    | All                  |
| Coast inverse           | [2]    | All, terminal 27     |
| Coast and reset inverse | [3]    | All                  |
| Quick stop inverse      | [4]    | All                  |
| DC brake inverse        | [5]    | All                  |
| Stop inverse            | [6]    | All                  |



| Digital input function       | Select | Terminal         |
|------------------------------|--------|------------------|
| Start                        | [8]    | All, terminal 18 |
| Latched start                | [9]    | All              |
| Reversing                    | [10]   | All, terminal 19 |
| Start reversing              | [11]   | All              |
| Enable start forward         | [12]   | All              |
| Enable start reverse         | [13]   | All              |
| Jog                          | [14]   | All, terminal 29 |
| Preset reference on          | [15]   | All              |
| Preset ref bit 0             | [16]   | All              |
| Preset ref bit 1             | [17]   | All              |
| Preset ref bit 2             | [18]   | All              |
| Freeze reference             | [19]   | All              |
| Freeze output                | [20]   | All              |
| Speed up                     | [21]   | All              |
| Speed down                   | [22]   | All              |
| Set-up select bit 0          | [23]   | All              |
| Set-up select bit 1          | [24]   | All              |
| Precise stop inverse         | [26]   | Terminal 18, 19  |
| Precise start, stop          | [27]   | Terminal 18, 19  |
| Catch up                     | [28]   | All              |
| Slow down                    | [29]   | All              |
| Counter input                | [30]   | Terminal 29, 33  |
| Pulse input edge triggered   | [31]   | Terminal 29, 33  |
| Pulse input time based       | [32]   | Terminal 29, 33  |
| Ramp bit 0                   | [34]   | All              |
| Ramp bit 1                   | [35]   | All              |
| Emergency mode               | [37]   | All              |
| Latched precise start        | [40]   | Terminal 18, 19  |
| Latched precise stop inverse | [41]   | Terminal 18, 19  |
| Restart drive                | [44]   |                  |
| External interlock           | [51]   | –                |
| DigiPot increase             | [55]   | All              |

| Digital input function       | Select | Terminal        |
|------------------------------|--------|-----------------|
| DigiPot decrease             | [56]   | All             |
| DigiPot clear                | [57]   | All             |
| DigiPot hoist                | [58]   | All             |
| Counter A (up)               | [60]   | Terminal 29, 33 |
| Counter A (down)             | [61]   | Terminal 29, 33 |
| Reset Counter A              | [62]   | All             |
| Counter B (up)               | [63]   | Terminal 29, 33 |
| Counter B (down)             | [64]   | Terminal 29, 33 |
| Reset Counter B              | [65]   | All             |
| Mech. brake feedb.           | [70]   | All             |
| Mech. brake feedb. inv.      | [71]   | All             |
| PID error inv.               | [72]   | All             |
| PID reset I-part             | [73]   | All             |
| PID enable                   | [74]   | All             |
| MCO specific                 | [75]   | All             |
| Reset maint. word            | [78]   |                 |
| PTC card 1                   | [80]   | All             |
| PROFIdrive OFF2              | [91]   | All             |
| PROFIdrive OFF3              | [92]   | All             |
| Light-load detection         | [94]   | All             |
| Evacuation                   | [95]   | All             |
| Mains loss                   | [96]   | Terminal 32, 33 |
| Mains loss inverse           | [97]   | Terminal 32, 33 |
| Start edge triggered         | [98]   | All             |
| Safety option reset          | [100]  | –               |
| Active CAM table             | [104]  |                 |
| Set vir. mas. pos. to actual | [105]  |                 |
| Enable master offset         | [108]  | All             |
| Start virtual master         | [109]  | All             |
| Start homing                 | [110]  | All             |
| Activate touch               | [111]  | All             |
| Relative position            | [112]  | All             |

| Digital input function  | Select | Terminal |
|-------------------------|--------|----------|
| Enable reference        | [113]  | All      |
| Sync. to pos. mode      | [114]  | All      |
| Home sensor             | [115]  | All      |
| Home sensor inverse     | [116]  | All      |
| Touch sensor            | [117]  | All      |
| Touch sensor inverse    | [118]  | All      |
| Speed mode              | [119]  | All      |
| Dir. home sensor        | [127]  | All      |
| Dir. home sen. inv.     | [128]  | All      |
| Emcy mode ref bit 0     | [190]  | All      |
| Emcy mod ref bit 1      | [191]  | All      |
| Emcy mode ref bit 2     | [192]  | All      |
| Emcy mode setup bit 0   | [193]  | All      |
| Emcy mode setup bit 1   | [194]  | All      |
| Test emcy mode          | [195]  | All      |
| Reset emcy mode         | [196]  | All      |
| Power limit mot.        | [231]  | All      |
| Power limit gen.        | [232]  | All      |
| Power limit both        | [233]  | All      |
| Light load + evacuation | [234]  | All      |

VLT® AutomationDrive FC 301/FC 302 standard terminals are 18, 19, 27, 29, 32, and 33. VLT® General Purpose I/O MCB 101 terminals are X30/2, X30/3, and X30/4. In FC 302, terminal 29 also functions as an output.

Functions dedicated to only 1 digital input are stated in the associated parameter.

All digital inputs can be programmed to these functions:

Table 328: Digital Inputs, Function Descriptions - 1

| Option                      | Function   |
|-----------------------------|--|
| [0] No operation            | No reaction to signals transmitted to the terminal.  |
| [1] Reset                   | Resets the drive after a trip/alarm. Not all alarms can be reset.  |
| [2] Coast inverse           | (Default digital input 27): Coast stop, inverted input (NC). The drive leaves the motor in free mode. Logic 0⇒coast stop.  |
| [3] Coast and reset inverse | Reset and coast stop inverted input (NC). Leaves the motor in free mode and resets the drive. Logic 0⇒coast stop and reset.  |
| [4] Quick stop inverse      | Inverted input (NC). Generates a stop in accordance with quick stop ramp time set in <i>parameter 3-81 Quick Stop Ramp Time</i> . When the motor stops, the shaft is in free mode. Logic 0⇒quick stop. |

| Option |                      | Function   |
|--------|----------------------|--|
| [5]    | DC brake inverse     | Inverted input for DC brake (NC). Stops motor by energizing it with a DC current for a certain time period. See <i>parameter 2-01 DC Brake Current</i> to <i>parameter 2-03 DC Brake Cut In Speed [RPM]</i> . The function is only active when the value in <i>parameter 2-02 DC Braking Time</i> is different from 0. Logic 0⇒DC brake.   |
| [6]    | Stop inverse         | <p>Stop inverted function. Generates a stop function when the selected terminal goes from logical level 1 to logical level 0.</p> <p>The stop is performed according to the selected ramp time:</p> <ul style="list-style-type: none"> <li>• <i>Parameter 3-42 Ramp 1 Ramp Down Time</i>,</li> <li>• <i>Parameter 3-52 Ramp 2 Ramp Down Time</i>,</li> <li>• <i>Parameter 3-62 Ramp 3 Ramp down Time</i>, and</li> <li>• <i>Parameter 3-72 Ramp 4 Ramp Down Time</i>.</li> </ul> <div style="background-color: #cccccc; text-align: center; padding: 5px;"><b>NOTICE</b></div> <p>When the drive is at the torque limit and has received a stop command, it may not stop by itself. To ensure that the drive stops, configure a digital output to <i>[27] Torque limit and stop</i>. Connect this digital output to a digital input that is configured as coast.</p> |
| [8]    | Start                | (Default digital input 18): Select start for a start/stop command. Logic 1 = start, logic 0 = stop.  |
| [9]    | Latched start        | If a pulse is applied for minimum 2 ms, the motor starts. The motor stops when stop inverse is activated, or a reset command (via DI, bus, or LCP) is given.   |
| [10]   | Reversing            | (Default digital input 19): Change the direction of motor shaft rotation. Select logic 1 to reverse. The reversing signal only changes the direction of rotation. It does not activate the start function. Select both directions in <i>parameter 4-10 Motor Speed Direction</i> . The function is not active in process closed loop.  |
| [11]   | Start reversing      | Used for start/stop and for reversing on the same wire. Signals on start are not allowed at the same time.   |
| [12]   | Enable start forward | Disengages the counterclockwise movement and allows clockwise direction.   |
| [13]   | Enable start reverse | Disengages the clockwise movement and allows counterclockwise direction.   |
| [14]   | Jog                  | (Default digital input 29): Activate jog speed. See <i>parameter 3-11 Jog Speed [Hz]</i> .   |
| [15]   | Preset reference on  | Shifts between external reference and preset reference. It is assumed that <i>[1] External/preset</i> has been selected in <i>parameter 3-04 Reference Function</i> . Logic 0 = external reference active; logic 1 = 1 of the 8 preset references is active.   |
| [16]   | Preset ref bit 0     | Preset reference bit 0, 1, and 2 enable a choice between 1 of the 8 preset references according to <a href="#">Table 329</a> .   |
| [17]   | Preset ref bit 1     | Same as <i>[16] Preset ref bit 0</i> .   |
| [18]   | Preset ref bit 2     | Same as <i>[16] Preset ref bit 0</i> .   |

Table 329: Preset Reference Bit

| Preset ref. bit | 2 | 1 | 0 |
|-----------------|---|---|---|
| Preset ref. 0   | 0 | 0 | 0 |
| Preset ref. 1   | 0 | 0 | 1 |
| Preset ref. 2   | 0 | 1 | 0 |

| Preset ref. bit | 2 | 1 | 0 |
|-----------------|---|---|---|
| Preset ref. 3   | 0 | 1 | 1 |
| Preset ref. 4   | 1 | 0 | 0 |
| Preset ref. 5   | 1 | 0 | 1 |
| Preset ref. 6   | 1 | 1 | 0 |
| Preset ref. 7   | 1 | 1 | 1 |

Table 330: Digital Inputs, Function Descriptions - 2

| Option  | Function  |
|---|---|
| [19] Freeze ref   | Freezes the actual reference, which is now the point of enable/condition to be used for [21] Speed up and [22] Speed down. If speed up/speed down is used, the speed change always follows ramp 2 (parameter 3-51 Ramp 2 Ramp Up Time and parameter 3-52 Ramp 2 Ramp Down Time) in the range 0–parameter 3-03 Maximum Reference.  |
| [20] Freeze output  | Freezes the actual motor frequency (Hz), which is now the point of enable/condition to be used for [21] Speed up and [22] Speed down. If speed up/speed down is used, the speed change always follows ramp 2 (parameter 3-51 Ramp 2 Ramp Up Time and parameter 3-52 Ramp 2 Ramp Down Time) in the range 0–parameter 1-23 Motor Frequency.   |
| <b>NOTICE</b>   |   |
| When freeze output is active, the drive cannot be stopped via a low [8] Start signal. Stop the drive via a terminal programmed for [2] Coasting inverse or [3] Coast and reset inverse. |   |
| [21] Speed up   | Select [21] Speed up and [22] Speed down for digital control of the up/down speed (motor potentiometer). Activate this function by selecting either [19] Freeze ref or [20] Freeze output. When speed up/speed down is activated for less than 400 ms, the resulting reference is increased/decreased by 0.1%. If speed up/speed down is activated for more than 400 ms, the resulting reference follows the setting in ramping up/down parameters 3-x1/3-x2. |

Table 331: Shut Down/Catch Up

|                      | Shut down | Catch up |
|----------------------|-----------|----------|
| Unchanged speed      | 0         | 0        |
| Reduced by %-value   | 1         | 0        |
| Increased by %-value | 0         | 1        |
| Reduced by %-value   | 1         | 1        |

Table 332: Digital Inputs, Function Descriptions - 3

| Option                   | Function   |
|--------------------------|--|
| [22] Speed down          | Same as [21] Speed up.   |
| [23] Set-up select bit 0 | Select [23] Set-up select bit 0 or select [24] Set-up select bit 1 to select 1 of the 4 set-ups. Set parameter 0-10 Active Set-up to [9] Multi Set-up. |
| [24] Set-up select bit 1 | (Default digital input 32): Same as [23] Set-up select bit 0.  |

| Option |                      | Function   |
|--------|----------------------|--|
| [26]   | Precise stop inv.    | Sends an inverted stop signal when the precise stop function is activated in <i>parameter 1-83 Precise Stop Function</i> . Precise stop inverse function is available for terminals 18 or 19.  |
| [27]   | Precise start, stop  | Use when [0] <i>Precise ramp stop</i> is selected in <i>parameter 1-83 Precise Stop Function</i> . Precise start, stop is available for terminals 18 and 19. Precise start ensures that the rotor turning angle from standing still to reference is the same for each start (for same ramp time, same setpoint). This function is the equivalent to the precise stop where the rotor turning angle from reference to standstill is the same for each stop. When using <i>parameter 1-83 Precise Stop Function</i> option [1] <i>Cnt stop with reset</i> or [2] <i>Cnt stop w/o reset</i> : The drive needs a precise stop signal before reaching the value of <i>parameter 1-84 Precise Stop Counter Value</i> . If this signal is not supplied, the drive does not stop when the value in <i>parameter 1-84 Precise Stop Counter Value</i> is reached. Trigger precise start, stop by a digital input. The function is available for terminals 18 and 19. |
| [28]   | Catch up             | Increases reference value by percentage (relative) set in <i>parameter 3-12 Catch up/slow Down Value</i> .   |
| [29]   | Slow down            | Reduces reference value by percentage (relative) set in <i>parameter 3-12 Catch up/slow Down Value</i> .   |
| [30]   | Counter input        | Precise stop function in <i>parameter 1-83 Precise Stop Function</i> acts as counter stop or speed-compensated counter stop with or without reset. Set the counter value in <i>parameter 1-84 Precise Stop Counter Value</i> .   |
| [31]   | Pulse edge triggered | Counts the number of pulse flanks per sample time. This gives a higher resolution at high frequencies, but is not as precise at lower frequencies. Use this pulse principle for encoders with low resolution (for example 30 PPR).<br><br> <p><b>Illustration 61: Pulse Flanks per Sample Time</b></p>   |
| [32]   | Pulse time-based     | Measures the duration between pulse flanks. This gives a higher resolution at lower frequencies, but is not as precise at higher frequencies. This principle has a cutoff frequency, which makes it unsuited for encoders with low resolutions (for example 30 PPR) at low speeds.<br><br> <p><b>Illustration 62: Duration Between Pulse Flanks</b></p>   |
| [34]   | Ramp bit 0           | Enables a selection between 1 of the 4 ramps available, according to <a href="#">Table 333</a> .   |
| [35]   | Ramp bit 1           | Same as [34] <i>Ramp bit 0</i> .   |

Table 333: Preset Ramp Bit

| Preset ramp bit | 1 | 0 |
|-----------------|---|---|
| Ramp 1          | 0 | 0 |
| Ramp 2          | 0 | 1 |
| Ramp 3          | 1 | 0 |
| Ramp 4          | 1 | 1 |

Table 334: Digital Inputs, Function Descriptions - 4

| Option                            | Function  |
|-----------------------------------|---|
| [37] Emergency mode               | A signal applied puts the drive into emergency mode and the preset ref bits 0–2 define the operation mode of emergency mode where all other commands are disregarded. See <i>parameter group 24-0* Emergency Mode</i> and <i>parameter group 24-2* Emergency Mode 2</i> .   |
| [40] Latched precise start        | A latched precise start only requires a pulse of 3 ms on terminals 18 or 19. When using for <i>parameter 1-83 Precise Stop Function</i> [1] <i>Cnt stop with reset</i> or [2] <i>Cnt stop w/o reset</i> : When the reference is reached, the drive internally enables the precise stop signal. This means that the drive does the precise stop when the counter value of <i>parameter 1-84 Precise Stop Counter Value</i> is reached. |
| [41] Latched precise stop inverse | Sends a latched stop signal when the precise stop function is activated in <i>parameter 1-83 Precise Stop Function</i> . The latched precise stop inverse function is available for terminals 18 or 19.   |
| [44] Restart drive                |   |
| [51] External interlock           | This function makes it possible to give an external fault to the drive. This fault is treated in the same way as an internally generated alarm.   |
| [55] DigiPot increase             | Increase signal to the digital potentiometer function described in <i>parameter group 3-9* Digital Pot. Meter</i> .   |
| [56] DigiPot Decrease             | Decrease signal to the digital potentiometer function described in <i>parameter group 3-9* Digital Pot. Meter</i> .   |
| [57] DigiPot Clear                | Clears the digital potentiometer reference described in <i>parameter group 3-9* Digital Pot. Meter</i> .  |
| [58] DigiPot hoist                |   |
| [60] Counter A (up)               | (Terminal 29 or 33 only). Input for increment counting in the SLC counter.  |
| [61] Counter A (down)             | (Terminal 29 or 33 only). Input for decrement counting in the SLC counter.  |
| [62] Reset Counter A              | Input for reset of counter A.   |
| [63] Counter B (up)               | (Terminal 29 or 33 only). Input for increment counting in the SLC counter.  |
| [64] Counter B (down)             | (Terminal 29 or 33 only). Input for decrement counting in the SLC counter.  |
| [65] Reset Counter B              | Input for reset of counter B.   |
| [70] Mech. Brake Feedback         | Brake feedback for hoisting applications: Set <i>parameter 1-01 Motor Control Principle</i> to [3] <i>Flux w/ motor feedback</i> ; set <i>parameter 1-72 Start Function</i> to [6] <i>Hoist mech brake Ref</i> .  |
| [71] Mech. Brake Feedback inv.    | Inverted brake feedback for hoisting applications.  |
| [72] PID error inverse            | When enabled, this option inverts the resulting error from the process PID controller. Available only if <i>parameter 1-00 Configuration Mode</i> is set to [6] <i>Surface Winder</i> , [7] <i>Extended PID Speed OL</i> , or [8] <i>Extended PID Speed CL</i> .  |
| [73] PID reset I-part             | When enabled, this option resets the I-part of the process PID controller. Equivalent to <i>parameter 7-40 Process PID I-part Reset</i> . Available only if <i>parameter 1-00 Configuration Mode</i> is set to [6] <i>Surface Winder</i> , [7] <i>Extended PID Speed OL</i> , or [8] <i>Extended PID Speed CL</i> .   |
| [74] PID enable                   | Enables the extended process PID controller. Equivalent to <i>parameter 7-50 Process PID Extended PID</i> . Available only if <i>parameter 1-00 Configuration Mode</i> is set to [7] <i>Extended PID Speed OL</i> or [8] <i>Extended PID Speed CL</i> .   |

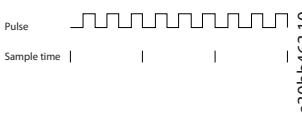
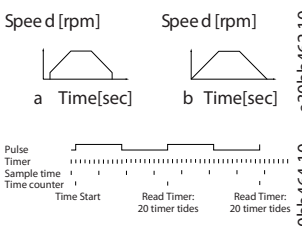
| Option |                      | Function   |
|--------|----------------------|--|
| [75]   | MCO specific         |  |
| [78]   | Preset main. word    |  |
| [80]   | PTC Card 1           | All digital inputs can be set to [80] PTC Card 1. However, only 1 digital input must be set to this option.  |
| [91]   | PROFIdrive OFF2      | The functionality is the same as the corresponding control word bit of the PROFIBUS/PROFINET option.   |
| [92]   | PROFIdrive OFF3      | The functionality is the same as the corresponding control word bit of the PROFIBUS/PROFINET option.   |
| [94]   | Light Load Detection | <p>Light-load detection is a feature for lift application to ensure that the lift runs in the evacuation direction which requires the least energy (UPS capacity), during an emergency. See <i>parameter 30-25 Light Load Delay [s]</i>, <i>parameter 30-26 Delay Before Measurements</i>, <i>parameter 30-27 Light Load Speed [%]</i>, <i>parameter 30-28 Evacuation Speed [%]</i>, and <i>parameter 30-29 Ramp Time</i> for light-load detection configurations.</p> <div style="text-align: center; background-color: #cccccc; padding: 5px;"><b>NOTICE</b></div> <p>Flying start overrules light load detection.</p> |
| [95]   | Evacuation           | Evacuation Mode is a feature for lift application to enable drives to operate at reduced DC voltage for evacuation of people if there is power failure. When the feature is activated, undervoltage limits and enable voltage limits are reduced so that the drive can be operated with 230 V single-phase UPS-supply.   |
| [96]   | Mains loss           | <p>Select to improve kinetic back-up. When the mains voltage goes back to a level that is close to (but still lower than) the detection level, the output speed increases and kinetic back-up remains active. To avoid this situation, send a status signal to the drive. When the signal on the digital input is low (0), the drive forcibly turns off the kinetic back-up.</p> <div style="text-align: center; background-color: #cccccc; padding: 5px;"><b>NOTICE</b></div> <p>Only available for pulse inputs at terminals 32/33.</p>  |
| [97]   | Mains loss inverse   | <p>When the signal on the digital input is high (1), the drive forcibly turns off the kinetic back-up. For more details, see the description of [96] Mains loss.</p> <div style="text-align: center; background-color: #cccccc; padding: 5px;"><b>NOTICE</b></div> <p>Only available for pulse inputs at terminals 32/33.</p>  |
| [98]   | Start edge triggered | Edge-triggered start command. Keeps the start command alive. It can be used for a start push key.  |
| [100]  | Safety option reset  | Resets the safety option. Available only when the safety option is mounted.  |
| [104]  | Activate CAM table   | <div style="text-align: center; background-color: #cccccc; padding: 5px;"><b>NOTICE</b></div> <p>This option is only available with software version 48.XX.</p> <p>Signal for activation of new CAM table while running with bumpless transfer.</p>  |



| Option |                              | Function  |
|--------|------------------------------|---|
| [105]  | Set vir. mas. pos. to actual | <p style="text-align: center;"><b>NOTICE</b></p> <p>This option is only available with software version 48.XX.</p> <p>Signal for setting virtual master position = actual follower position. This is needed for setting the correct starting position for position-controlled virtual master ensuring that the virtual master position is aligned with the physical position of the follower.</p> |
| [106]  | Set master home              | <p style="text-align: center;"><b>NOTICE</b></p> <p>This option is only available with software version 48.XX.</p> <p>Sets the actual master position to the value of <i>parameter 17-88 Master Home Position</i>.</p>  |
| [107]  | Target inverse               | <p style="text-align: center;"><b>NOTICE</b></p> <p>This option is only available with software version 48.XX.</p> <p>Changes the sign of the set target position. For example, if the set target is 1000, the activation of this option changes the value to -1000.</p>  |
| [108]  | Enable master offset         | <p style="text-align: center;"><b>NOTICE</b></p> <p>This option is only available with software version 48.XX.</p> <p>Activates the master offset selected in <i>parameter 3-26 Master Offset</i> when <i>parameter 17-93 Master Offset Selection</i> has a selection from [1] Absolute to [5] Relative Touch Sensor.</p>   |
| [109]  | Enable. vir.mas-ter          | <p style="text-align: center;"><b>NOTICE</b></p> <p>This option is only available with software version 48.XX.</p> <p>Enable signal for the virtual master function. Only applicable when option [10] Synchronization is selected in <i>parameter 1-00 Configuration Mode</i>.</p>  |
| [110]  | Start homing                 | <p style="text-align: center;"><b>NOTICE</b></p> <p>This option is only available with software version 48.XX.</p> <p>Starts the homing function selected in <i>parameter 17-80 Homing Function</i>. Must remain high until homing is done, otherwise homing is aborted.</p>  |
| [111]  | Activate touch               | <p style="text-align: center;"><b>NOTICE</b></p> <p>This option is only available with software version 48.XX.</p> <p>Activates monitoring of the touch sensor input.</p>   |
| [112]  | Relative position            | <p style="text-align: center;"><b>NOTICE</b></p> <p>This option is only available with software version 48.XX.</p>  |

| Option |                    | Function   |
|--------|--------------------|--|
|        |                    | This option selects between absolute and relative positioning. The option is valid for the next positioning command.   |
| [113]  | Enable reference   | <div style="background-color: #cccccc; text-align: center; padding: 2px;"><b>NOTICE</b></div> <div style="border: 1px solid black; padding: 2px; margin: 2px 0;">This option is only available with software version 48.XX.</div> <p>Positioning mode: The drive activates the selected positioning type and target, and starts the motion towards the new target. The motion starts either immediately or when active positioning is completed, depending on the settings of <i>parameter 17-90 Absolute Position Mode</i> and <i>parameter 17-91 Relative Position Mode</i>.</p> <p>Synchronization mode: High signal locks the actual follower position to the actual master position. The follower starts and catches up with the master. Low signal stops the synchronization and the follower makes a controlled stop.</p> |
| [114]  | Sync. to pos. mode | <div style="background-color: #cccccc; text-align: center; padding: 2px;"><b>NOTICE</b></div> <div style="border: 1px solid black; padding: 2px; margin: 2px 0;">This option is only available with software version 48.XX.</div> <p>Select positioning in synchronization mode.</p>   |
| [115]  | Home sensor        | <div style="background-color: #cccccc; text-align: center; padding: 2px;"><b>NOTICE</b></div> <div style="border: 1px solid black; padding: 2px; margin: 2px 0;">This option is only available with software version 48.XX.</div> <p>Normally-open contact for defining the home position. The function is defined in <i>parameter 17-80 Homing Function</i>.</p>  |
| [116]  | Home sensor inv.   | <div style="background-color: #cccccc; text-align: center; padding: 2px;"><b>NOTICE</b></div> <div style="border: 1px solid black; padding: 2px; margin: 2px 0;">This option is only available with software version 48.XX.</div> <p>Normally-closed contact for defining the home position. The function is defined in <i>parameter 17-80 Homing Function</i>.</p>  |
| [117]  | Touch sensor       | <div style="background-color: #cccccc; text-align: center; padding: 2px;"><b>NOTICE</b></div> <div style="border: 1px solid black; padding: 2px; margin: 2px 0;">This option is only available with software version 48.XX.</div> <p>Normally-open contact. Serves as a reference for touch probe positioning.</p>   |
| [118]  | Touch sensor inv   | <div style="background-color: #cccccc; text-align: center; padding: 2px;"><b>NOTICE</b></div> <div style="border: 1px solid black; padding: 2px; margin: 2px 0;">This option is only available with software version 48.XX.</div> <p>Normally-closed contact. Serves as a reference for touch probe positioning.</p>   |
| [119]  | Speed mode         | <div style="background-color: #cccccc; text-align: center; padding: 2px;"><b>NOTICE</b></div> <div style="border: 1px solid black; padding: 2px; margin: 2px 0;">This option is only available with software version 48.XX.</div>  |

| Option |                      | Function   |
|--------|----------------------|--|
|        |                      | Select the speed mode when [9] Positioning or [10] Synchronization is selected in parameter 1-00 Configuration Mode. Speed reference is set by reference resource 1 or fieldbus REF1 relative to parameter 3-03 Maximum Reference.   |
| [122]  | Position vir. master | <div style="text-align: center; background-color: #cccccc; padding: 5px;"><b>NOTICE</b></div> <div style="border: 1px solid black; padding: 5px; margin: 5px 0;">This option is only available with software version 48.XX.</div> Activates position-controlled virtual master when [10] Synchronization is selected in parameter 1-00 Configuration Mode. When the option is selected, the following occurs: <ul style="list-style-type: none"> <li>Target position is set by Fieldbus Pos. Ref. or preset target is as defined in parameter 3-20 Preset Target.</li> <li>Speed is set relative to parameter 3-27 Virtual Master Max Ref by the source selected in parameter 3-15 Reference Resource 1 or fieldbus REF1.</li> <li>Acceleration and deceleration are set as defined in parameter group 3-6* Ramp 3.</li> </ul> |
| [123]  | Master marker        | <div style="text-align: center; background-color: #cccccc; padding: 5px;"><b>NOTICE</b></div> <div style="border: 1px solid black; padding: 5px; margin: 5px 0;">This option is only available with software version 48.XX.</div> Normally-open contact. Serves as input for master marker signal during marker synchronization based on the option selected in parameter 3-33 Sync. Mode & Start behavior.  |
| [124]  | Master marker inv.   | <div style="text-align: center; background-color: #cccccc; padding: 5px;"><b>NOTICE</b></div> <div style="border: 1px solid black; padding: 5px; margin: 5px 0;">This option is only available with software version 48.XX.</div> Normally-closed contact. Activates master marker signal for marker synchronization based on the option selected in parameter 3-33 Sync. Mode & Start Behavior.   |
| [125]  | Follower marker      | <div style="text-align: center; background-color: #cccccc; padding: 5px;"><b>NOTICE</b></div> <div style="border: 1px solid black; padding: 5px; margin: 5px 0;">This option is only available with software version 48.XX.</div> Normally-open contact. Serves as input for follower marker signal during marker synchronization based on the option selected in parameter 3-33 Sync. Mode & Start Behavior.  |
| [126]  | Follow marker inv    | <div style="text-align: center; background-color: #cccccc; padding: 5px;"><b>NOTICE</b></div> <div style="border: 1px solid black; padding: 5px; margin: 5px 0;">This option is only available with software version 48.XX.</div> Normally-closed contact. Serves as input for follower marker signal during marker synchronization based on the option selected in parameter 3-33 Sync. Mode & Start Behavior.  |
| [127]  | Dir. home sensor     | <div style="text-align: center; background-color: #cccccc; padding: 5px;"><b>NOTICE</b></div> <div style="border: 1px solid black; padding: 5px; margin: 5px 0;">This option is only available with software version 48.XX.</div> Normally open contact for defining the home position at the same edge of the sensor signal independent of running direction. Only for the 2 homing types [2] Home Sync and [9] Direction with Sensor.  |

| Option |                         | Function  |
|--------|-------------------------|---|
| [128]  | Dir. home sen. inv.     | <p style="text-align: center;"><b>NOTICE</b></p> <p>This option is only available with software version 48.XX.</p> <p>Normally closed contact for defining the home position at the same edge of the sensor signal independent of running direction. Only for the 2 homing types [2] <i>Home Sync</i> and [9] <i>Direction with Sensor</i>.</p> |
| [190]  | Emcy mode ref bit 0     | Enables a choice between 1 of the 8 preset reference according to <a href="#">Table 329</a> .   |
| [191]  | Emcy mode ref bit 1     | Enables a choice between 1 of the 8 preset reference according to <a href="#">Table 329</a> .   |
| [192]  | Emcy mode ref bit 2     | Enables a choice between 1 of the 8 preset reference according to <a href="#">Table 329</a> .   |
| [193]  | Emcy mode setup bit 0   | Switch between emergency mode setup 1 to 4 in <i>parameter group 24-0* Emergency Mode</i> and <i>parameter group 24-4* Emergency Mode 2</i> without changing starting setup mode for the rest of the parameters.  |
| [194]  | Emcy mode setup bit 1   | Switch between emergency mode setup 1 to 4 in <i>parameter group 24-0* Emergency Mode</i> and <i>parameter group 24-4* Emergency Mode 2</i> without changing starting setup mode for the rest of the parameters.  |
| [195]  | Test emcy mode          | Activation of emergency mode via <i>parameter 24-09 Emergency Mode Alarm Handling</i> , option [2] <i>Trip all alarms/test</i> with stop on all alarms and in normal operation mode. The test timer is set in <i>parameter 24-42 Timeout for Emergency Mode Test</i> , and countdown starts when the test signal is active.                     |
| [196]  | Reset emcy mode         | When operating in emergency mode with impulse signals ( <i>parameter 24-43 Emergency Mode Signal Operation</i> , option [2] <i>Impulse, set-reset</i> ) the reset signal stops the emergency mode operation.  |
| [231]  | Power limit mot.        | <p style="text-align: center;"><b>NOTICE</b></p> <p>This option is only available in FC 302.</p> <p>Serves as input to activate the power limit function in the motor mode. See <i>parameter group 4-8* Power Limit</i>.</p>  |
| [232]  | Power limit gen.        | <p style="text-align: center;"><b>NOTICE</b></p> <p>This option is only available in FC 302.</p> <p>Serves as input to activate the power limit function in the generating mode. See <i>parameter group 4-8* Power Limit</i>.</p>   |
| [233]  | Power limit both        | <p style="text-align: center;"><b>NOTICE</b></p> <p>This option is only available in FC 302.</p> <p>Serves as input to activate the power limit function in both the motor and the generating mode. See <i>parameter group 4-8* Power Limit</i>.</p>  |
| [234]  | Light load + evacuation | <p style="text-align: center;"><b>NOTICE</b></p> <p>This option is only available in FC 302.</p> <p>Use this option to activate both light-load detection and evacuation.</p>   |

## Parameter 5-10 Terminal 18 Digital Input

Table 335: Parameter 5-10 Terminal 18 Digital Input

| 5-10 Terminal 18 Digital Input |                        |                               |
|--------------------------------|------------------------|-------------------------------|
| Default value: Size related    | Parameter type: Option | Setup: All setups             |
| Conversion index: –            | Data type: Uint8       | Change during operation: True |

Select the function from the available digital input range and the additional options [60] Counter A (up), [61] Counter A (down), [63] Counter B (up), and [64] Counter B (down). Counters are used in smart logic control functions. All functions are described in [Table 328](#), [Table 330](#), [Table 332](#), and [Table 334](#).

| Option | Name                 | Description |
|--------|----------------------|-------------|
| [0]    | No operation         |             |
| [1]    | Reset                |             |
| [2]    | Coast inverse        |             |
| [3]    | Coast and reset inv  |             |
| [4]    | Quick stop inverse   |             |
| [5]    | DC-brake inverse     |             |
| [6]    | Stop inverse         |             |
| [8]    | Start                |             |
| [9]    | Latched              |             |
| [10]   | Reversing            |             |
| [11]   | Start reversing      |             |
| [12]   | Enable start forward |             |
| [13]   | Enable start reverse |             |
| [14]   | Jog                  |             |
| [15]   | Preset reference on  |             |
| [16]   | Preset ref bit 0     |             |
| [17]   | Preset ref bit 1     |             |
| [18]   | Preset ref bit 2     |             |
| [19]   | Freeze reference     |             |
| [20]   | Freeze output        |             |
| [21]   | Speed up             |             |
| [22]   | Speed down           |             |
| [23]   | Set-up select bit 0  |             |
| [24]   | Set-up select bit 1  |             |
| [26]   | Precise stop inverse |             |
| [27]   | Precise start, stop  |             |

| Option | Name                    | Description |
|--------|-------------------------|-------------|
| [28]   | Catch up                |             |
| [29]   | Slow down               |             |
| [34]   | Ramp bit 0              |             |
| [35]   | Ramp bit 1              |             |
| [37]   | Emergency mode          |             |
| [40]   | Latched precise start   |             |
| [41]   | Latch prec stop inv     |             |
| [44]   | Restart drive           |             |
| [51]   | External interlock      |             |
| [55]   | DigiPot increase        |             |
| [56]   | DigiPot decrease        |             |
| [57]   | DigiPot clear           |             |
| [58]   | DigiPot hoist           |             |
| [62]   | Reset counter A         |             |
| [65]   | Reset counter B         |             |
| [70]   | Mech. brake feedb.      |             |
| [71]   | Mech. brake feedb. inv. |             |
| [72]   | PID error inverse       |             |
| [73]   | PID reset 1 part        |             |
| [74]   | PID enable              |             |
| [75]   | MCO specific            |             |
| [78]   | Reset maint. word       |             |
| [80]   | PTC card 1              |             |
| [91]   | PROFIdrive OFF2         |             |
| [92]   | PROFIdrive OFF3         |             |
| [94]   | Light load detection    |             |
| [95]   | Evacuation mode         |             |
| [96]   | Mains loss              |             |
| [97]   | Mains loss inverse      |             |
| [98]   | Start edge triggered    |             |
| [100]  | Safe option reset       |             |
| [104]  | Active CAM table        |             |

| Option | Name                         | Description |
|--------|------------------------------|-------------|
| [105]  | Set vir. mas. pos. to actual |             |
| [106]  | Set master home              |             |
| [107]  | Target inverse               |             |
| [108]  | Enable mast. offset          |             |
| [109]  | Enable vir. master           |             |
| [110]  | Start homing                 |             |
| [111]  | Activate touch               |             |
| [112]  | Relative position            |             |
| [113]  | Enable reference             |             |
| [114]  | Sync. to pos. mode           |             |
| [115]  | Home sensor                  |             |
| [116]  | Home sensor inv.             |             |
| [117]  | Touch sensor                 |             |
| [118]  | Touch sensor inv.            |             |
| [119]  | Speed mode                   |             |
| [122]  | Position vir. master         |             |
| [123]  | Master marker                |             |
| [124]  | Master marker inv.           |             |
| [125]  | Follower marker              |             |
| [126]  | Follow. marker inv.          |             |
| [127]  | Dir. home sensor             |             |
| [128]  | Dir. home sen. inv.          |             |
| [190]  | Emcy mode ref bit 0          |             |
| [191]  | Emcy mode ref bit 1          |             |
| [192]  | Emcy mode ref bit 2          |             |
| [193]  | Emcy mode setup bit 0        |             |
| [194]  | Emcy mode setup bit 1        |             |
| [195]  | Test emcy mode               |             |
| [196]  | Reset emcy mode              |             |
| [231]  | Power limit mot.             |             |

| Option | Name                    | Description |
|--------|-------------------------|-------------|
| [232]  | Power limit gen.        |             |
| [233]  | Power limit both        |             |
| [234]  | Light load + evacuation |             |

## Parameter 5-11 Terminal 19 Digital Input

Table 336: Parameter 5-11 Terminal 19 Digital Input

| 5-11 Terminal 19 Digital Input |                        |                               |
|--------------------------------|------------------------|-------------------------------|
| Default value: Size related    | Parameter type: Option | Setup: All setups             |
| Conversion index: –            | Data type: Uint8       | Change during operation: True |

The options for this parameter are the same as those listed for *parameter 5-10 Terminal 18 Digital Input*.

## Parameter 5-12 Terminal 27 Digital Input

Table 337: Parameter 5-12 Terminal 27 Digital Input

| 5-12 Terminal 27 Digital Input |                        |                               |
|--------------------------------|------------------------|-------------------------------|
| Default value: Size related    | Parameter type: Option | Setup: All setups             |
| Conversion index: –            | Data type: Uint8       | Change during operation: True |

The options for this parameter are the same as those listed for *parameter 5-10 Terminal 18 Digital Input*.

## Parameter 5-13 Terminal 29 Digital Input

Table 338: Parameter 5-13 Terminal 29 Digital Input

| 5-13 Terminal 29 Digital Input |                        |                               |
|--------------------------------|------------------------|-------------------------------|
| Default value: Size related    | Parameter type: Option | Setup: All setups             |
| Conversion index: –            | Data type: Uint8       | Change during operation: True |

The options for this parameter are the same as those listed for *parameter 5-10 Terminal 18 Digital Input*.

## Parameter 5-14 Terminal 32 Digital Input

Table 339: Parameter 5-14 Terminal 32 Digital Input

| 5-14 Terminal 32 Digital Input |                        |                               |
|--------------------------------|------------------------|-------------------------------|
| Default value: Size related    | Parameter type: Option | Setup: All setups             |
| Conversion index: –            | Data type: Uint8       | Change during operation: True |

The options for this parameter are the same as those listed for *parameter 5-10 Terminal 18 Digital Input*.

## Parameter 5-15 Terminal 33 Digital Inputs

Table 340: Parameter 5-15 Terminal 33 Digital Input

| 5-15 Terminal 33 Digital Input |                        |                               |
|--------------------------------|------------------------|-------------------------------|
| Default value: Size related    | Parameter type: Option | Setup: All setups             |
| Conversion index: –            | Data type: Uint8       | Change during operation: True |

The options for this parameter are the same as those listed for *parameter 5-10 Terminal 18 Digital Input*.



## Parameter 5-16 Terminal X30/2 Digital Input

Table 341: Parameter 5-16 Terminal X30/2 Digital Input

| 5-16 Terminal X30/2 Digital Input |                        |                               |
|-----------------------------------|------------------------|-------------------------------|
| Default value: Size related       | Parameter type: Option | Setup: All setups             |
| Conversion index: –               | Data type: Uint8       | Change during operation: True |

The options for this parameter are the same as those listed for *parameter 5-10 Terminal 18 Digital Input*.

## Parameter 5-17 Terminal X30/3 Digital Input

Table 342: Parameter 5-17 Terminal X30/3 Digital Input

| 5-17 Terminal X30/3 Digital Input |                        |                               |
|-----------------------------------|------------------------|-------------------------------|
| Default value: Size related       | Parameter type: Option | Setup: All setups             |
| Conversion index: –               | Data type: Uint8       | Change during operation: True |

The options for this parameter are the same as those listed for *parameter 5-10 Terminal 18 Digital Input*.

## Parameter 5-18 Terminal X30/4 Digital Input

Table 343: Parameter 5-18 Terminal X30/4 Digital Input

| 5-18 Terminal X30/4 Digital Input |                        |                               |
|-----------------------------------|------------------------|-------------------------------|
| Default value: Size related       | Parameter type: Option | Setup: All setups             |
| Conversion index: –               | Data type: Uint8       | Change during operation: True |

The options for this parameter are the same as those listed for *parameter 5-10 Terminal 18 Digital Input*.

## Parameter 5-19 Terminal 37 Safe Stop

Table 344: Parameter 5-19 Terminal 37 Safe Stop

| 5-19 Terminal 37 Safe Stop  |                        |                               |
|-----------------------------|------------------------|-------------------------------|
| Default value: Size related | Parameter type: Option | Setup: 1 setup                |
| Conversion index: –         | Data type: Uint8       | Change during operation: True |

## NOTICE

Options [4] PTC 1 Alarm to [9] PTC 1 & Relay W/A are only available when the VLT® PTC Thermistor Card MCB 112 is connected.

## NOTICE

Selecting Auto Reset/Warning enables automatic restart of the drive.

Use this parameter to configure the Safe Torque Off functionality. A warning message makes the drive coast the motor and enables the automatic restart. An alarm message makes the drive coast the motor and requires a manual restart (via a fieldbus, Digital I/O, or by pressing [RESET] on the LCP). When the VLT® PTC Thermistor Card MCB 112 is mounted, configure the PTC options to get the full benefit from the alarm handling.

| Op-tion | Name               | Description   |
|---------|--------------------|---|
| [1]     | Safe stop alarm    | Coasts the drive when Safe Torque Off is activated. Manual reset from LCP, digital input, or fieldbus.  |
| [3]     | Safe stop warn-ing | Coasts the drive when Safe Torque Off is activated (terminal 37 off). When the Safe Torque Off circuit is re-established, the drive continues without manual reset. |
| [4]     | PTC 1 alarm        | Coasts the drive when Safe Torque Off is activated. Manual reset from LCP, digital input, or fieldbus.  |

| Option | Name              | Description  |
|--------|-------------------|--|
| [5]    | PTC 2 warning     | Coasts the drive when Safe Torque Off is activated (terminal 37 off). When the Safe Torque Off circuit is re-established, the drive continues without manual reset, unless a digital input set to [80] PTC Card 1 is still enabled.  |
| [6]    | PTC 1 & Relay A   | This option is used when the VLT® PTC Thermistor Card MCB 112 gates with a stop key through a safety relay to terminal 37. Coasts the drive when Safe Torque Off is activated. Manual reset from LCP, digital input, or fieldbus.  |
| [7]    | PTC 1 & Relay W   | This option is used when the VLT® PTC Thermistor Card MCB 112 gates with a stop key through a safety relay to terminal 37. Coasts the drive when Safe Torque Off is activated (terminal 37 off). When the Safe Torque Off circuit is re-established, the drive continues without manual reset, unless a digital input set to [80] PTC Card 1 is still enabled. |
| [8]    | PTC 1 & Relay A/W | This option enables using a combination of alarm and warning.  |
| [9]    | PTC 1 & Relay W/A | This option enables using a combination of warning and alarm.  |

Table 345: Overview of Functions, Alarms, and Warnings

| Function                | Number | PTC | Relay                                 |
|-------------------------|--------|-----|---------------------------------------|
| No function             | [0]    | –   | –                                     |
| Safe Torque Off alarm   | [1]*   | –   | Safe Torque Off [A68 <sup>(1)</sup> ] |
| Safe Torque Off warning | [3]    | –   | Safe Torque Off [W68 <sup>(1)</sup> ] |

<sup>1</sup> W means warning and A means alarm.

A dangerous failure related to STO issues *alarm 72, Dangerous Failure*.  
 Parameter 5-20 Terminal X46/1 Digital Input

Table 346: Parameter 5-20 Terminal X46/1 Digital Input

| 5-20 Terminal X46/1 Digital Input |                        |                               |
|-----------------------------------|------------------------|-------------------------------|
| Default value: [0] No operation   | Parameter type: Option | Setup: All setups             |
| Conversion index: –               | Data type: Uint8       | Change during operation: True |

All functions are described in [Table 328](#), [Table 330](#), [Table 332](#), and [Table 334](#).

| Option | Name                | Description |
|--------|---------------------|-------------|
| [0]*   | No operation        |             |
| [1]    | Reset               |             |
| [2]    | Coast inverse       |             |
| [3]    | Coast and reset inv |             |
| [4]    | Quick stop inverse  |             |
| [5]    | DC-brake inverse    |             |
| [6]    | Stop inverse        |             |
| [8]    | Start               |             |

| Option | Name                  | Description |
|--------|-----------------------|-------------|
| [9]    | Latched               |             |
| [10]   | Reversing             |             |
| [11]   | Start reversing       |             |
| [12]   | Enable start forward  |             |
| [13]   | Enable start reverse  |             |
| [14]   | Jog                   |             |
| [15]   | Preset reference on   |             |
| [16]   | Preset ref bit 0      |             |
| [17]   | Preset ref bit 1      |             |
| [18]   | Preset ref bit 2      |             |
| [19]   | Freeze reference      |             |
| [20]   | Freeze output         |             |
| [21]   | Speed up              |             |
| [22]   | Speed down            |             |
| [23]   | Set-up select bit 0   |             |
| [24]   | Set-up select bit 1   |             |
| [26]   | Precise stop inverse  |             |
| [27]   | Precise start, stop   |             |
| [28]   | Catch up              |             |
| [29]   | Slow down             |             |
| [34]   | Ramp bit 0            |             |
| [35]   | Ramp bit 1            |             |
| [37]   | Emergency mode        |             |
| [40]   | Latched precise start |             |
| [41]   | Latch prec stop inv   |             |
| [44]   | Restart drive         |             |
| [51]   | External interlock    |             |
| [55]   | DigiPot increase      |             |
| [56]   | DigiPot decrease      |             |
| [57]   | DigiPot clear         |             |
| [58]   | DigiPot hoist         |             |
| [62]   | Reset counter A       |             |

| Option | Name                    | Description  |
|--------|-------------------------|--|
| [65]   | Reset counter B         |  |
| [70]   | Mech. brake feedb.      |  |
| [71]   | Mech. brake feedb. inv. |  |
| [72]   | PID error inverse       |  |
| [73]   | PID reset 1 part        |  |
| [74]   | PID enable              |  |
| [75]   | MCO specific            |  |
| [78]   | Reset maint. word       |  |
| [80]   | PTC card 1              |  |
| [91]   | PROFIdrive OFF2         |  |
| [92]   | PROFIdrive OFF3         |  |
| [94]   | Light load detection    | <p style="text-align: center;"><b>NOTICE</b></p> <p>This option is only available in FC 302.</p> |
| [95]   | Evacuation mode         | <p style="text-align: center;"><b>NOTICE</b></p> <p>This option is only available in FC 302.</p> |
| [96]   | Mains loss              |  |
| [97]   | Mains loss inverse      |  |
| [98]   | Start edge triggered    |  |
| [100]  | Safe option reset       |  |
| [106]  | Set master home         |  |
| [107]  | Target inverse          |  |
| [122]  | Position vir. master    |  |
| [123]  | Master marker           |  |
| [124]  | Master marker inv       |  |
| [125]  | Follower marker         |  |
| [126]  | Follow. marker inv.     |  |
| [190]  | Emcy mode ref bit 0     |  |
| [191]  | Emcy mode ref bit 1     |  |
| [192]  | Emcy mode ref bit 2     |  |
| [195]  | Test emcy mode          |  |

| Option | Name                    | Description  |
|--------|-------------------------|--|
| [196]  | Reset emcy mode         |  |
| [231]  | Power limit mot.        | <p style="text-align: center;"><b>NOTICE</b></p> <p>This option is only available in FC 302.</p> |
| [232]  | Power limit gen.        | <p style="text-align: center;"><b>NOTICE</b></p> <p>This option is only available in FC 302.</p> |
| [233]  | Power limit both        | <p style="text-align: center;"><b>NOTICE</b></p> <p>This option is only available in FC 302.</p> |
| [234]  | Light load + evacuation | <p style="text-align: center;"><b>NOTICE</b></p> <p>This option is only available in FC 302.</p> |

## Parameter 5-21 Terminal X46/3 Digital Input

Table 347: Parameter 5-21 Terminal X46/3 Digital Input

| 5-21 Terminal X46/3 Digital Input |                        |                               |
|-----------------------------------|------------------------|-------------------------------|
| Default value: [0] No operation   | Parameter type: Option | Setup: All setups             |
| Conversion index: –               | Data type: Uint8       | Change during operation: True |

The options for this parameter are the same as those listed for *parameter 5-20 Terminal X46/1 Digital Input*.

## Parameter 5-22 Terminal X46/5 Digital Input

Table 348: Parameter 5-22 Terminal X46/5 Digital Input

| 5-22 Terminal X46/5 Digital Input |                        |                               |
|-----------------------------------|------------------------|-------------------------------|
| Default value: [0] No operation   | Parameter type: Option | Setup: All setups             |
| Conversion index: –               | Data type: Uint8       | Change during operation: True |

The options for this parameter are the same as those listed for *parameter 5-20 Terminal X46/1 Digital Input*.

## Parameter 5-23 Terminal X46/7 Digital Input

Table 349: Parameter 5-23 Terminal X46/7 Digital Input

| 5-23 Terminal X46/7 Digital Input |                        |                               |
|-----------------------------------|------------------------|-------------------------------|
| Default value: [0] No operation   | Parameter type: Option | Setup: All setups             |
| Conversion index: –               | Data type: Uint8       | Change during operation: True |

The options for this parameter are the same as for those listed for *parameter 5-20 Terminal X46/1 Digital Input*.

Parameter 5-24 Terminal X46/9 Digital Input

Table 350: Parameter 5-24 Terminal X46/9 Digital Input

| 5-24 Terminal X46/9 Digital Input |                        |                               |
|-----------------------------------|------------------------|-------------------------------|
| Default value: [0] No operation   | Parameter type: Option | Setup: All setups             |
| Conversion index: –               | Data type: Uint8       | Change during operation: True |

The options for this parameter are the same as those listed for *parameter 5-20 Terminal X46/1 Digital Input*.

Parameter 5-25 Terminal X46/11 Digital Input

Table 351: Parameter 5-25 Terminal X46/11 Digital Input

| 5-25 Terminal X46/11 Digital Input |                        |                               |
|------------------------------------|------------------------|-------------------------------|
| Default value: [0] No operation    | Parameter type: Option | Setup: All setups             |
| Conversion index: –                | Data type: Uint8       | Change during operation: True |

The options for this parameter are the same as those listed for *parameter 5-20 Terminal X46/1 Digital Input*.

Parameter 5-26 Terminal X46/13 Digital Input

Table 352: Parameter 5-26 Terminal X46/13 Digital Input

| 5-26 Terminal X46/13 Digital Input |                        |                               |
|------------------------------------|------------------------|-------------------------------|
| Default value: [0] No operation    | Parameter type: Option | Setup: All setups             |
| Conversion index: –                | Data type: Uint8       | Change during operation: True |

The options for this parameter are the same as those listed for *parameter 5-20 Terminal X46/1 Digital Input*.

### 5.6.3 5-3\* Digital Outputs

## NOTICE

The following parameter is only available in FC 302:

- *Parameter 5-31 Terminal 29 Digital Output*

The 2 solid-state digital outputs are common for terminals 27 and 29. Set the I/O function for terminal 27 in *parameter 5-01 Terminal 27 Mode*, and set the I/O function for terminal 29 in *parameter 5-02 Terminal 29 Mode*.

## NOTICE

These parameters cannot be adjusted while the motor is running.

Table 353: Digital Outputs, Function Descriptions - 1

| Option                 | Function  |
|------------------------|---|
| [0] No operation       | Default for all digital outputs and relay outputs.  |
| [1] Control ready      | The control card is ready.  |
| [2] Drive ready        | The drive is ready for operation and applies a supply signal on the control card.                     |
| [3] Drive rdy/rem ctrl | The drive is ready for operation and is in auto-on mode.  |
| [4] Enable/no warning  | Ready for operation. No start or stop command has been given (start/disable). No warnings are active. |
| [5] Running            | The motor runs, and shaft torque is present.  |

| Option |                       | Function  |
|--------|-----------------------|---|
| [6]    | Running/no warning    | The output speed is higher than the speed set in <i>parameter 1-81 Min Speed for Function at Stop [RPM]</i> . The motor runs and there are no warnings.                             |
| [7]    | Run in range/no warn  | The motor runs within the programmed current and speed ranges set in <i>parameter 4-50 Warning Current Low</i> to <i>parameter 4-53 Warning Speed High</i> . There are no warnings. |
| [8]    | Run on ref/no warn    | The motor runs at reference speed. There are no warnings.   |
| [9]    | Alarm                 | An alarm activates the output. There are no warnings.   |
| [10]   | Alarm or warning      | An alarm or warning activates the output.   |
| [11]   | At torque limit       | The torque limit set in <i>parameter 4-16 Torque Limit Motor Mode</i> or <i>parameter 4-17 Torque Limit Generator Mode</i> has been exceeded.                                       |
| [12]   | Out of current range  | The motor current is outside the range set in <i>parameter 4-18 Current Limit</i> .   |
| [13]   | Below current, low    | The motor current is lower than set in <i>parameter 4-50 Warning Current Low</i> .  |
| [14]   | Above current, high   | The motor current is higher than set in <i>parameter 4-51 Warning Current High</i> .  |
| [15]   | Out of speed range    | The output frequency is outside the frequency range set in <i>parameter 4-52 Warning Speed Low</i> and <i>parameter 4-53 Warning Speed High</i> .                                   |
| [16]   | Below speed, low      | Output speed is lower than the setting in <i>parameter 4-52 Warning Speed Low</i> .   |
| [17]   | Above speed, high     | The output speed is higher than the setting in <i>parameter 4-53 Warning Speed High</i> .   |
| [18]   | Out of feedb. range   | Feedback is below the limit set in <i>parameter 4-56 Warning Feedback Low</i> and <i>parameter 4-57 Warning Feedback High</i> .   |
| [19]   | Below feedback, low   | Feedback is below the limit set in <i>parameter 4-56 Warning Feedback Low</i> .   |
| [20]   | Above feedback, high  | Feedback is above the limit set in <i>parameter 4-57 Warning Feedback High</i> .  |
| [21]   | Thermal warning       | The thermal warning turns on when the temperature exceeds the limit in the motor, the drive, the brake resistor, or the thermistor.   |
| [22]   | Ready, no thermal W   | The drive is ready for operation, and there is no overtemperature warning.  |
| [23]   | Remote, ready, no TW  | The drive is ready for operation and is in auto-on mode. There is no overtemperature warning.   |
| [24]   | Ready, voltage OK     | The drive is ready for operation and the mains voltage is within the specified voltage range.   |
| [25]   | Reverse               | The motor runs (or is ready to run) clockwise when logic = 0 and runs counterclockwise when logic = 1. The output changes when the reversing signal is applied.                     |
| [26]   | Bus OK                | Active communication (no timeout) via the serial communication port.  |
| [27]   | Torque limit & stop   | Used for coast stop and in torque limit conditions. If the drive has received a stop signal and is at the torque limit, the signal is logic 0.                                      |
| [28]   | Brake, no brake war   | Brake is active, and there are no warnings.   |
| [29]   | Brake ready, no fault | Brake is ready for operation and there are no faults.   |

| Option |                         | Function   |
|--------|-------------------------|--|
| [30]   | Brake fault (IGBT)      | Output is logic 1 when the brake IGBT is short-circuited. Use this function to protect the drive if there is a fault on the brake modules. To cut out the main voltage from the drive, use the output/relay. |
| [31]   | Relay 123               | Relay is activated when [0] Control Word is selected in parameter group 8-** Communications and Options.   |
| [32]   | Mech brake ctrl         | Enables control of an external mechanical brake. For more information on mechanical brake control, refer to the drive-specific design guide.   |
| [33]   | Safe stop active        | Indicates that the Safe Torque Off on terminal 37 is activated.  |
| [35]   | External interlock      |  |
| [38]   | Motor feedback error    |  |
| [39]   | Tracking Error          |  |
| [40]   | Out of ref range        | Active when the actual speed is outside settings in parameter 4-52 Warning Speed Low in parameter 4-55 Warning Reference High.   |
| [41]   | Below reference, low    | Active when the actual speed is below speed reference setting.   |
| [42]   | Above ref, high         | Active when the actual speed is above speed reference setting.   |
| [43]   | Extended PID limit      |  |
| [45]   | Bus ctrl.               | Controls output via bus. The state of the output is set in parameter 5-90 Digital & Relay Bus Control. If a bus timeout occurs, the output state is retained.  |
| [46]   | Bus ctrl, 1 if timeout  | Controls output via bus. The state of the output is set in parameter 5-90 Digital & Relay Bus Control. If a bus timeout occurs, the output state is set high (on).   |
| [47]   | Bus ctrl, 0 if timeout  | Controls output via bus. The state of the output is set in parameter 5-90 Digital & Relay Bus Control. If a bus timeout occurs, the output state is set low (off).   |
| [50]   | On reference            | Active when a VLT® Advanced Cascade Controller MCO 102 or VLT® Motion Control MCO 305 is connected. The output is controlled from the option.  |
| [51]   | MCO controlled          | Active when a VLT® Advanced Cascade Controller MCO 102 or VLT® Motion Control MCO 305 is connected. The output is controlled from the option.  |
| [54]   | 24V encoder sim         | Digital outputs 27 and 29 simulate a single-signal HTL encoder. Select source for the signal generation in parameter 5-78 Term 27/29 Encoder Sim.  |
| [55]   | Pulse output            |  |
| [58]   | Actual position         |  |
| [59]   | Actual position 4–20 mA |  |
| [60]   | Comparator 0            | See parameter group 13-1* Comparators. If comparator 0 is evaluated as true, the output goes high. Otherwise, it is low.   |
| [61]   | Comparator 1            | See parameter group 13-1* Comparators. If comparator 1 is evaluated as true, the output goes high. Otherwise, it is low.   |
| [62]   | Comparator 2            | See parameter group 13-1* Comparators. If comparator 2 is evaluated as true, the output goes high. Otherwise, it is low.   |



| Option |                     | Function  |
|--------|---------------------|---|
| [63]   | Comparator 3        | See <i>parameter group 13-1* Comparators</i> . If comparator 3 is evaluated as true, the output goes high. Otherwise, it is low.  |
| [64]   | Comparator 4        | See <i>parameter group 13-1* Comparators</i> . If comparator 4 is evaluated as true, the output goes high. Otherwise, it is low.  |
| [65]   | Comparator 5        | See <i>parameter group 13-1* Comparators</i> . If comparator 5 is evaluated as true, the output goes high. Otherwise, it is low.  |
| [66]   | Comparator 6        | See <i>parameter group 13-1* Comparators</i> . If comparator 6 is evaluated as true, the output goes high. Otherwise, it is low.  |
| [67]   | Comparator 7        | See <i>parameter group 13-1* Comparators</i> . If comparator 7 is evaluated as true, the output goes high. Otherwise, it is low.  |
| [68]   | Comparator 8        | See <i>parameter group 13-1* Comparators</i> . If comparator 8 is evaluated as true, the output goes high. Otherwise, it is low.  |
| [69]   | Comparator 9        | See <i>parameter group 13-1* Comparators</i> . If comparator 9 is evaluated as true, the output goes high. Otherwise, it is low.  |
| [70]   | Logic rule 0        | See <i>parameter group 13-4* Logic Rules</i> . If logic rule 0 is evaluated as true, the output goes high. Otherwise, it is low.  |
| [71]   | Logic rule 1        | See <i>parameter group 13-4* Logic Rules</i> . If logic rule 1 is evaluated as true, the output goes high. Otherwise, it is low.  |
| [72]   | Logic rule 2        | See <i>parameter group 13-4* Logic Rules</i> . If logic rule 2 is evaluated as true, the output goes high. Otherwise, it is low.  |
| [73]   | Logic rule 3        | See <i>parameter group 13-4* Logic Rules</i> . If logic rule 3 is evaluated as true, the output goes high. Otherwise, it is low.  |
| [74]   | Logic rule 4        | See <i>parameter group 13-4* Logic Rules</i> . If logic rule 4 is evaluated as true, the output goes high. Otherwise, it is low.  |
| [75]   | Logic rule 5        | See <i>parameter group 13-4* Logic Rules</i> . If logic rule 5 is evaluated as true, the output goes high. Otherwise, it is low.  |
| [80]   | SL digital output A | See <i>parameter 13-52 SL Controller Action</i> . The output goes high whenever the smart logic action [38] <i>Set dig. out. A high</i> is executed. The output goes low whenever the smart logic action [32] <i>Set dig. out. A low</i> is executed. |
| [81]   | SL digital output B | See <i>parameter 13-52 SL Controller Action</i> . The output goes high whenever the smart logic action [39] <i>Set dig. out. B high</i> is executed. The output goes low whenever the smart logic action [33] <i>Set dig. out. B low</i> is executed. |
| [82]   | SL digital output C | See <i>parameter 13-52 SL Controller Action</i> . The output goes high whenever the smart logic action [40] <i>Set dig. out. C high</i> is executed. The output goes low whenever the smart logic action [34] <i>Set dig. out. C low</i> is executed. |
| [83]   | SL digital output D | See <i>parameter 13-52 SL Controller Action</i> . The output goes high whenever the smart logic action [41] <i>Set dig. out. D high</i> is executed. The output goes low whenever the smart logic action [35] <i>Set dig. out. D low</i> is executed. |
| [84]   | SL digital output E | See <i>parameter 13-52 SL Controller Action</i> . The output goes high whenever the smart logic action [42] <i>Set dig. out. E high</i> is executed. The output goes low whenever the smart logic action [36] <i>Set dig. out. E low</i> is executed. |
| [85]   | SL digital output F | See <i>parameter 13-52 SL Controller Action</i> . The output goes high whenever the smart logic action [43] <i>Set dig. out. F high</i> is executed. The output goes low whenever the smart logic action [37] <i>Set dig. out. F low</i> is executed. |

| Option |                     | Function  |
|--------|---------------------|---|
| [90]   | kWh counter pulse   | Sends a pulse (200 ms pulse width) to output terminal whenever kWh counter changes ( <i>parameter 15-02 kWh Counter</i> ).  |
| [90]   | kWh counter pulse   | <div style="text-align: center; background-color: #cccccc; padding: 5px;"><b>NOTICE</b></div> <p>This option is only available with software version 48.XX.</p> <p>Sends a pulse (200 ms pulse width) to the output terminal whenever kWh counter changes (<i>parameter 15-02 kWh Counter</i>).</p> |
| [98]   | Virtual master dir. | <div style="text-align: center; background-color: #cccccc; padding: 5px;"><b>NOTICE</b></div> <p>This option is only available with software version 48.XX.</p> <p>A virtual master signal that controls the rotation direction of followers.</p>   |
| [120]  | Local ref active    | Output is high when <i>parameter 313 Reference Site = [2] Local</i> .   |

Table 354: Local Reference Active

| Reference site set in <i>parameter 3-13 Reference Site</i>             | Local reference active [120] | Remote reference active [121] |
|--|------------------------------|-------------------------------|
| Reference site: Local <i>parameter 3-13 Reference Site [2] Local</i>   | 1                            | 0                             |
| Reference site: Remote <i>parameter 3-13 Reference Site [1] Remote</i> | 0                            | 1                             |
| Reference site: Linked to Hand/ Auto                                   | –                            | –                             |
| Hand   | 1                            | 0                             |
| Hand⇒off   | 1                            | 0                             |
| Auto⇒off   | 0                            | 0                             |
| Auto   | 0                            | 1                             |

Table 355: 5-30 Digital Outputs - 2

| Option |                      | Function   |
|--------|----------------------|--|
| [121]  | Remote ref active    | Output is high when <i>parameter 3-13 Reference Site = [1] Remote</i> or <i>[0] Linked to hand/auto</i> while the LCP is in auto-on mode. See <a href="#">Table 354</a> .                        |
| [122]  | No alarm             | Output is high when no alarm is present.   |
| [123]  | Start command active | Output is high when there is an active start command (that is via digital input bus connection, hand-on, or auto-on), and no stop or start command is active.                                    |
| [124]  | Running reverse      | Output is high when the drive runs counterclockwise (the logical product of the status bits running AND reverse).  |
| [125]  | Drive in hand mode   | Output is high when the drive is in hand-on mode (as indicated by the LED light above [Hand On]).  |
| [126]  | Drive in auto mode   | Output is high when the drive is in auto-on mode (as indicated by the LED light above [Auto On]).  |
| [151]  | ATEX ETR cur. alarm  | Selectable if <i>parameter 1-90 Motor Thermal Protection</i> is set to <i>[20] ATEX ETR</i> or <i>[21] Advanced ETR</i> . If <i>Alarm 164 ATEX ETR cur.lim.alarm</i> is active, the output is 1. |

| Option |                        | Function   |
|--------|------------------------|--|
| [152]  | ATEX ETR freq. alarm   | Selectable if <i>parameter 1-90 Motor Thermal Protection</i> is set to [20] ATEX ETR or [21] Advanced ETR. If <i>Alarm 166, ATEX ETR freq.lim.alarm</i> is active, the output is 1.  |
| [153]  | ATEX ETR cur. warning  |  |
| [154]  | ATEX ETR freq. warning | Selectable if <i>parameter 1-90 Motor Thermal Protection</i> is set to [20] ATEX ETR or [21] Advanced ETR. If <i>Warning 165, ATEX ETR freq.lim.warning</i> is active, the output is 1.  |
| [173]  | 10Wh counter pulse     |  |
| [178]  | RS Flipflop 8          |  |
| [179]  | RS Flipflop 9          |  |
| [180]  | Clock fault            |  |
| [181]  | Prev. maintenance      |  |
| [188]  | AHF capacitor connect  | The capacitors are turned on at 20% (hysteresis of 50% gives an interval of 10– 30%). The capacitors are disconnected below 10%. The off delay is 10 s and restarts if the nominal power goes above 10% during the delay. <i>Parameter 5-80 AHF Cap Reconnect Delay</i> is used to guarantee a minimum off time for the capacitors.            |
| [189]  | External fan control   | The internal logics for the internal fan control is transferred to this output to make it possible to control an external fan (relevant for hp duct cooling).  |
| [190]  | Safe function active   |  |
| [191]  | Safe opt. reset req.   |  |
| [192]  | RS Flipflop 0          | See <i>parameter group 13-1* Comparators</i> .   |
| [193]  | RS Flipflop 1          | See <i>parameter group 13-1* Comparators</i> .   |
| [194]  | RS Flipflop 2          | See <i>parameter group 13-1* Comparators</i> .   |
| [195]  | RS Flipflop 3          | See <i>parameter group 13-1* Comparators</i> .   |
| [196]  | RS Flipflop 4          | See <i>parameter group 13-1* Comparators</i> .   |
| [197]  | RS Flipflop 5          | See <i>parameter group 13-1* Comparators</i> .   |
| [198]  | RS Flipflop 6          | See <i>parameter group 13-1* Comparators</i> .   |
| [199]  | RS Flipflop 7          | See <i>parameter group 13-1* Comparators</i> .   |
| [221]  | IGBT cooling           | Use this option for handling the overcurrent trips. When the drive detects an overcurrent condition, it shows <i>alarm 13, Overcurrent</i> and triggers a reset. If the overcurrent condition occurs for the 3 <sup>rd</sup> time in a row, the drive shows <i>alarm 13, Overcurrent</i> and initiates a 3-minute delay before the next reset. |
| [222]  | Homing OK              | <div style="text-align: center; background-color: #cccccc; padding: 5px;"><b>NOTICE</b></div> <p>This option is only available with software version 48.XX.</p> <p>Homing is completed with the selected homing function in <i>parameter 17-80 Homing Function</i>.</p>  |

| Option |                     | Function  |
|--------|---------------------|---|
| [223]  | On target           | <p style="text-align: center;"><b>NOTICE</b></p> <p>This option is only available with software version 48.XX.</p> <p>Positioning is completed and the on-target signal is sent when the actual position is within <i>parameter 3-05 On Reference Window</i> for the duration of <i>parameter 3-09 On Target Time</i> and the actual speed does not exceed <i>parameter 3-05 On Reference Window</i>.</p> |
| [224]  | Position limit      | <p style="text-align: center;"><b>NOTICE</b></p> <p>This option is only available with software version 48.XX.</p> <p>The position error exceeds the value in <i>parameter 4-71 Maximum Position Error</i> for the time set in <i>parameter 4-72 Position Error Timeout</i>.</p>  |
| [225]  | Position error      | <p style="text-align: center;"><b>NOTICE</b></p> <p>This option is only available with software version 48.XX.</p> <p>The position is outside the limits set in <i>parameter 3-06 Minimum Position</i> and <i>parameter 3-07 Maximum Position</i>.</p>  |
| [226]  | Touch on target     | <p style="text-align: center;"><b>NOTICE</b></p> <p>This option is only available with software version 48.XX.</p> <p>The target position is reached in touch probe position mode.</p>  |
| [227]  | Touch activated     | <p style="text-align: center;"><b>NOTICE</b></p> <p>This option is only available with software version 48.XX.</p> <p>Touch probe positioning is active. The drive monitors the touch probe sensor input.</p>   |
| [228]  | Touch sensor found  | <p style="text-align: center;"><b>NOTICE</b></p> <p>This option is only available with software version 48.XX.</p> <p>The touch sensor has been detected.</p>   |
| [229]  | Vir. master on ref. | <p style="text-align: center;"><b>NOTICE</b></p> <p>This option is only available with software version 48.XX.</p> <p>The virtual master is running on the set reference.</p>   |
| [231]  | In power lim. mot.  |   |
| [232]  | In power lim. gen.  |   |
| [233]  | In power limit      |   |
| [234]  | PE power off        |   |

| Option |                         | Function  |
|--------|-------------------------|---|
| [246]  | Emcy mode was act.      | The drive has been operating in emergency mode.   |
| [247]  | Emergency mode          | The drive is operating in emergency mode. See <i>parameter group 24-0* Emergency Mode</i> .   |
| [249]  | Emcy m. OPR unex-pected | Emergency mode input or safe stop is not operating as expected, for example, live zero monitoring on an analog input is activated.  |
| [250]  | Emcy mode limits        | During emergency mode operation, 1 of the critical alarms has been activated and suppressed by emergency mode. This may lead to reduced drive performance and expected operation lifetime before service is required. |
| [254]  | Testing emcy mode       | Emergency mode is activated in a special test mode where the drive stops on all alarms.   |

## Parameter 5-30 Terminal 27 Digital Output

Table 356: Parameter 5-30 Terminal 27 Digital Output

| 5-30 Terminal 27 Digital Output |                        |                               |
|---------------------------------|------------------------|-------------------------------|
| Default value: Size related     | Parameter type: Option | Setup: All setups             |
| Conversion index: –             | Data type: Uint8       | Change during operation: True |

Select the function from the available digital output range and the additional options [60] Counter A (up), [61] Counter A (down), [63] Counter B (up), and [64] Counter B (down). Counters are used in smart logic control functions. All functions are described in [Table 353](#) and [Table 355](#).

| Option | Name                 | Description |
|--------|----------------------|-------------|
| [0]    | No operation         |             |
| [1]    | Control ready        |             |
| [2]    | Drive ready          |             |
| [3]    | Coast and reset inv  |             |
| [4]    | Enable/no warning    |             |
| [5]    | Running              |             |
| [6]    | Running/no warning   |             |
| [7]    | Run in range/no warn |             |
| [8]    | Run on ref/no warn   |             |
| [9]    | Alarm                |             |
| [10]   | Alarm or warning     |             |
| [11]   | At torque limit      |             |
| [12]   | Out of current range |             |
| [13]   | Below current, low   |             |
| [14]   | Above current, high  |             |
| [15]   | Out of speed range   |             |
| [16]   | Below speed, low     |             |
| [17]   | Above speed, high    |             |

| Option | Name                   | Description |
|--------|------------------------|-------------|
| [18]   | Out of feedb. range    |             |
| [19]   | Below feedback, low    |             |
| [20]   | Above feedback, high   |             |
| [21]   | Thermal warning        |             |
| [22]   | Ready,no thermal W     |             |
| [23]   | Remote,ready, no TW    |             |
| [24]   | Ready, Voltage OK      |             |
| [25]   | Reverse                |             |
| [26]   | Bus OK                 |             |
| [27]   | Torque limit & stop    |             |
| [28]   | Brake, no brake war    |             |
| [29]   | Brake ready, no fault  |             |
| [30]   | Brake fault (IGBT)     |             |
| [31]   | Relay 123              |             |
| [32]   | Mech brake ctrl        |             |
| [33]   | Safe stop active       |             |
| [35]   | External interlock     |             |
| [38]   | Motor feedback error   |             |
| [39]   | Tracking error         |             |
| [40]   | Out of ref range       |             |
| [41]   | Below reference, low   |             |
| [42]   | Above ref, high        |             |
| [43]   | Extended PID Limit     |             |
| [45]   | Bus ctrl.              |             |
| [46]   | Bus ctrl, 1 if timeout |             |
| [47]   | Bus ctrl, 0 if timeout |             |
| [50]   | On reference           |             |
| [54]   | 24V Encoder Sim        |             |
| [55]   | Pulse output           |             |
| [58]   | Actual position        |             |
| [59]   | Actual position 4–20mA |             |
| [60]   | Comparator 0           |             |

| Option | Name                | Description |
|--------|---------------------|-------------|
| [61]   | Comparator 1        |             |
| [62]   | Comparator 2        |             |
| [63]   | Comparator 3        |             |
| [64]   | Comparator 4        |             |
| [65]   | Comparator 5        |             |
| [66]   | Comparator 6        |             |
| [67]   | Comparator 7        |             |
| [68]   | Comparator 8        |             |
| [69]   | Comparator 9        |             |
| [70]   | Logic rule 0        |             |
| [71]   | Logic rule 1        |             |
| [72]   | Logic rule 2        |             |
| [73]   | Logic rule 3        |             |
| [74]   | Logic rule 4        |             |
| [75]   | Logic rule 5        |             |
| [79]   | PE power off        |             |
| [80]   | SL digital output A |             |
| [81]   | SL digital output B |             |
| [82]   | SL digital output C |             |
| [83]   | SL digital output D |             |
| [84]   | SL digital output E |             |
| [85]   | SL digital output F |             |
| [90]   | kWh counter pulse   |             |
| [96]   | Reverse after ramp  |             |
| [98]   | Virtual master dir  |             |
| [120]  | Local ref active    |             |
| [121]  | Remote ref active   |             |
| [122]  | No alarm            |             |
| [123]  | Start command activ |             |
| [124]  | Running reverse     |             |
| [125]  | Drive in hand mode  |             |
| [126]  | Drive in auto mode  |             |

| Option | Name                   | Description |
|--------|------------------------|-------------|
| [151]  | ATEX ETR cur. alarm    |             |
| [152]  | ATEX ETR freq. alarm   |             |
| [153]  | ATEX ETR cur. warning  |             |
| [154]  | ATEX ETR freq. warning |             |
| [173]  | 10Wh counter pulse     |             |
| [178]  | RS Flipflops 8         |             |
| [179]  | RS flipflops 9         |             |
| [180]  | Clock fault            |             |
| [181]  | Prev. Maintenance      |             |
| [188]  | AHF Capacitor Connect  |             |
| [189]  | External Fan Control   |             |
| [190]  | Safe Function active   |             |
| [191]  | Safe Opt. Reset req.   |             |
| [192]  | RS Flipflop 0          |             |
| [193]  | RS Flipflop 1          |             |
| [194]  | RS Flipflop 2          |             |
| [195]  | RS Flipflop 3          |             |
| [196]  | RS Flipflop 4          |             |
| [197]  | RS Flipflop 5          |             |
| [198]  | RS Flipflop 6          |             |
| [199]  | RS Flipflop 7          |             |
| [221]  | IGBT-cooling           |             |
| [222]  | Homing OK              |             |
| [223]  | On target              |             |
| [224]  | Position limit         |             |
| [225]  | Position error         |             |
| [226]  | Touch on target        |             |
| [227]  | Touch activated        |             |
| [228]  | Touch sensor found     |             |
| [229]  | Vir. master on ref.    |             |
| [231]  | In Power Lim. Mot.     |             |
| [232]  | In Power Lim. Gen.     |             |



| Option | Name                   | Description |
|--------|------------------------|-------------|
| [233]  | In Power Limit         |             |
| [234]  | PE power off           |             |
| [246]  | Emcy mode was act.     |             |
| [247]  | Emergency mode         |             |
| [249]  | Emcy m. OPR unexpected |             |
| [250]  | Emcy mode limits       |             |
| [254]  | Testing emcy mode      |             |

### Parameter 5-31 Terminal 29 Digital Output

**Table 357: Parameter 5-31 Terminal 29 Digital Output**

| 5-31 Terminal 29 Digital Output |                        |                               |
|---------------------------------|------------------------|-------------------------------|
| Default value: Size related     | Parameter type: Option | Setup: All setups             |
| Conversion index: –             | Data type: Uint8       | Change during operation: True |

The options for this parameter are the same as those listed for *parameter 5-30 Terminal 27 Digital Output*.

### Parameter 5-32 Term X30/6 Digi Out (MCB 101)

**Table 358: Parameter 5-32 Term X30/6 Digi Out (MCB 101)**

| 5-32 Term X30/6 Digi Out (MCB 101) |                        |                               |
|------------------------------------|------------------------|-------------------------------|
| Default value: Size related        | Parameter type: Option | Setup: All setups             |
| Conversion index: –                | Data type: Uint8       | Change during operation: True |

This parameter is active when option module VLT® General Purpose I/O MCB 101 is mounted in the drive. The options for this parameter are the same as those listed for *parameter 5-30 Terminal 27 Digital Output*.

**Table 359: Parameter 5-33 Term X30/7 Digi Out (MCB 101)**

| 5-33 Term X30/7 Digi Out (MCB 101) |                        |                               |
|------------------------------------|------------------------|-------------------------------|
| Default value: Size related        | Parameter type: Option | Setup: All setups             |
| Conversion index: –                | Data type: Uint8       | Change during operation: True |

This parameter is active when option module VLT® General Purpose I/O MCB 101 is mounted in the drive. The options for this parameter are the same as those listed for *parameter 5-30 Terminal 27 Digital Output*.

## 5.6.4 5-4\* Relays

Parameters for configuring the timing and the output functions for the relays.

### Parameter 5-40 Function Relay

**Table 360: Parameter 5-40 Function Relay**

| 5-40 Function Relay         |                                   |                               |
|-----------------------------|-----------------------------------|-------------------------------|
| Default value: Size related | Parameter type: Option, Array [9] | Setup: All setups             |
| Conversion index: –         | Data type: Uint8                  | Change during operation: True |

Select options to define the function of the relays. Relay 1 [0], relay 2 [1]. With VLT® Extended Relay Card MCB 113 installed: Relay 3 [2], Relay 4 [3], Relay 5 [4], Relay 6 [5]. With VLT® Relay Card MCB 105 installed: Relay 7 [6], relay 8 [7], Relay 9 [8].

| Option | Name                 | Description  |
|--------|----------------------|--|
| [0]    | No operation         | All digital and relay outputs are by default set to No Operation.  |
| [1]    | Control ready        | The control card is ready.   |
| [2]    | Drive ready          | The drive is ready to operate. Mains and control supplies are OK.  |
| [3]    | Drive rdy/rem ctrl   | The drive is ready for operation and is in auto-on mode.   |
| [4]    | Enable/no warning    | Ready for operation. No start or stop commands have been applied (start/disable). No warnings are active.  |
| [5]    | Running              | The motor is running, and shaft torque is present.   |
| [6]    | Running/no warning   | Output speed is higher than the speed set in <i>parameter 1-81 Min Speed for Function at Stop [RPM]</i> . The motor runs and there are no warnings.                            |
| [7]    | Run in range/no warn | The motor runs within the programmed current and the speed ranges set in <i>parameter 4-50 Warning Current Low</i> and <i>parameter 4-53 Warning Speed High</i> . No warnings. |
| [8]    | Run on ref/no warn   | The motor runs at reference speed. No warnings.  |
| [9]    | Alarm                | An alarm activates the output. No warnings.  |
| [10]   | Alarm or warning     | An alarm or a warning activates the output.  |
| [11]   | At torque limit      | The torque limit set in <i>parameter 4-16 Torque Limit Motor Mode</i> or <i>parameter 4-17 Torque Limit Generator Mode</i> has been exceeded.                                  |
| [12]   | Out of current range | The motor current is outside the range set in <i>parameter 4-18 Current Limit</i> .  |
| [13]   | Below current, low   | The motor current is lower than set in <i>parameter 4-50 Warning Current Low</i> .   |
| [14]   | Above current, high  | The motor current is higher than set in <i>parameter 4-51 Warning Current High</i> .   |
| [15]   | Out of speed range   | Output speed/frequency is outside the frequency range set in <i>parameter 4-52 Warning Speed Low</i> and <i>parameter 4-53 Warning Speed High</i> .                            |
| [16]   | Below speed, low     | Output speed is lower than the setting in <i>parameter 4-52 Warning Speed Low</i> .  |
| [17]   | Above speed, high    | Output speed is higher than the setting in <i>parameter 4-53 Warning Speed High</i> .  |
| [18]   | Out of feedb. range  | Feedback is outside the range set in <i>parameter 4-56 Warning Feedback Low</i> and <i>parameter 4-57 Warning Feedback High</i> .  |
| [19]   | Below feedback, low  | Feedback is below the limit set in <i>parameter 4-56 Warning Feedback Low</i> .  |
| [20]   | Above feedback, high | Feedback is above the limit set in <i>parameter 4-57 Warning Feedback High</i> .   |
| [21]   | Thermal warning      | Thermal warning turns on when the temperature exceeds the limit either in motor, drive, brake resistor, or connected thermistor.   |
| [22]   | Ready,no thermal W   | The drive is ready for operation and there is no overtemperature warning.  |
| [23]   | Remote,ready, no TW  | The drive is ready for operation and is in auto-on mode. There is no overtemperature warning.  |
| [24]   | Ready, Voltage OK    | The drive is ready for operation and the mains voltage is within the specified voltage range.  |
| [25]   | Reverse              | The motor runs (or is ready to run) clockwise when logic = 0 and counterclockwise when logic = 1. The output changes as soon as the reversing signal is applied.               |
| [26]   | Bus OK               | Active communication (no timeout) via the serial communication port.   |

| Option | Name                   | Description   |
|--------|------------------------|---|
| [27]   | Torque limit & stop    | Use for performing a coasted stop in a torque limit condition. If the drive has received a stop signal and is in torque limit, the signal is logic 0.   |
| [28]   | Brake, no brake war    | Brake is active and there are no warnings.  |
| [29]   | Brake ready, no fault  | Brake is ready for operation and there are no faults.   |
| [30]   | Brake fault (IGBT)     | Output is logic 1 when the brake IGBT is short-circuited. Use this function to protect the drive if there is a fault on the brake module. Use the digital output/relay to cut out the main voltage from the drive.  |
| [31]   | Relay 123              | Digital output/relay is activated when [0] Control Word is selected in <i>parameter group 8-*** Comm. and Options</i> .   |
| [32]   | Mech brake ctrl        | Selection of mechanical brake control. When selected parameters in <i>parameter group 2-2* Mechanical Brake</i> are active. The output must be reinforced to carry the current for the coil in the brake. Usually solved by connecting an external relay to the selected digital output.  |
| [33]   | Safe stop active       | <div style="text-align: center; background-color: #cccccc; padding: 5px;"><b>NOTICE</b></div> <p>This option is only available in FC 302.</p> <p>Indicates that the Safe Torque Off on terminal 37 has been activated.</p>  |
| [35]   | External interlock     |   |
| [36]   | Control word bit 11    | Activate relay 1 by control word from fieldbus. No other functional impact in the drive. Typical application: Controlling auxiliary device from fieldbus. The function is valid when [0] FC profile in <i>parameter 8-10 Control Word Profile</i> is selected.  |
| [37]   | Control word bit 12    | <div style="text-align: center; background-color: #cccccc; padding: 5px;"><b>NOTICE</b></div> <p>This option is only available in FC 302.</p> <p>Activate relay 2 by control word from fieldbus. No other functional impact in the drive. Typical application: Controlling auxiliary device from fieldbus. The function is valid when [0] FC profile in <i>parameter 8-10 Control Word Profile</i> is selected.</p> |
| [38]   | Motor feedback error   | Failure in the speed feedback loop from motor running in closed loop. The output can eventually be used to prepare switching the drive in open loop in an emergency case.   |
| [39]   | Tracking error         | When the difference between calculated speed and actual speed in <i>parameter 4-35 Tracking Error</i> is larger than selected, the digital output/relay is active.  |
| [40]   | Out of ref range       | Active when the actual speed is outside the settings in <i>parameter 4-52 Warning Speed Low</i> to <i>parameter 4-55 Warning Reference High</i> .   |
| [41]   | Below reference, low   | Active when the actual speed is below speed reference setting.  |
| [42]   | Above ref, high        | Active when actual speed is above speed reference setting.  |
| [43]   | Extended PID Limit     |   |
| [45]   | Bus ctrl.              | Controls digital output/relay via bus. The state of the output is set in <i>parameter 5-90 Digital &amp; Relay Bus Control</i> . The output state is retained in the event of bus timeout.  |
| [46]   | Bus ctrl, 1 if timeout | Controls output via bus. The state of the output is set in <i>parameter 5-90 Digital &amp; Relay Bus Control</i> . If a bus timeout occurs, the output state is set high (on).  |

| Option | Name                   | Description  |
|--------|------------------------|--|
| [47]   | Bus ctrl, 0 if timeout | Controls output via bus. The state of the output is set in parameter <i>5-90 Digital &amp; Relay Bus Control</i> . If a bus timeout occurs, the output state is set low (off). |
| [50]   | On reference           |  |
| [51]   | MCO controlled         |  |
| [59]   | Remote, enable, no TW  |  |
| [60]   | Comparator 0           | See <i>parameter group 13-1* Comparators</i> . If comparator 0 in SLC is true, the output goes high. Otherwise, it is low.   |
| [61]   | Comparator 1           | See <i>parameter group 13-1* Comparators</i> . If comparator 1 in SLC is true, the output goes high. Otherwise, it is low.   |
| [62]   | Comparator 2           | See <i>parameter group 13-1* Comparators</i> . If comparator 2 in SLC is true, the output goes high. Otherwise, it is low.   |
| [63]   | Comparator 3           | See <i>parameter group 13-1* Comparators</i> . If comparator 3 in SLC is true, the output goes high. Otherwise, it is low.   |
| [64]   | Comparator 4           | See <i>parameter group 13-1* Comparators</i> . If comparator 4 in SLC is true, the output goes high. Otherwise, it is low.   |
| [65]   | Comparator 5           | See <i>parameter group 13-1* Comparators</i> . If comparator 5 in SLC is true, the output goes high. Otherwise, it is low.   |
| [66]   | Comparator 6           | See <i>parameter group 13-1* Comparators</i> . If comparator 6 in SLC is true, the output goes high. Otherwise, it is low.   |
| [67]   | Comparator 7           | See <i>parameter group 13-1* Comparators</i> . If comparator 7 in SLC is true, the output goes high. Otherwise, it is low.   |
| [68]   | Comparator 8           | See <i>parameter group 13-1* Comparators</i> . If comparator 8 in SLC is true, the output goes high. Otherwise, it is low.   |
| [69]   | Comparator 9           | See <i>parameter group 13-1* Comparators</i> . If comparator 9 in SLC is true, the output goes high. Otherwise, it is low.   |
| [70]   | Logic rule 0           | See <i>parameter group 13-4* Logic Rules</i> . If logic rule 0 in SLC is true, the output goes high. Otherwise, it is low.   |
| [71]   | Logic rule 1           | See <i>parameter group 13-4* Logic Rules</i> . If logic rule 1 in SLC is true, the output goes high. Otherwise, it is low.   |
| [72]   | Logic rule 2           | See <i>parameter group 13-4* Logic Rules</i> . If logic rule 2 in SLC is true, the output goes high. Otherwise, it is low.   |
| [73]   | Logic rule 3           | See <i>parameter group 13-4* Logic Rules</i> . If logic rule 3 in SLC is true, the output goes high. Otherwise, it is low.   |
| [74]   | Logic rule 4           | See <i>parameter group 13-4* Logic Rules</i> . If logic rule 4 in SLC is true, the output goes high. Otherwise, it is low.   |
| [75]   | Logic rule 5           | See <i>parameter group 13-4* Logic Rules</i> . If logic rule 5 in SLC is true, the output goes high. Otherwise, it is low.   |
| [76]   | Logic rule 6           | See <i>parameter group 13-4* Logic Rules</i> . If logic rule 6 in SLC is true, the output goes high. Otherwise, it is low.   |
| [77]   | Logic rule 7           | See <i>parameter group 13-4* Logic Rules</i> . If logic rule 7 in SLC is true, the output goes high. Otherwise, it is low.   |

| Option | Name                | Description   |
|--------|---------------------|---|
| [78]   | Logic rule 8        | See <i>parameter group 13-4* Logic Rules</i> . If logic rule 8 in SLC is true, the output goes high. Otherwise, it is low.  |
| [79]   | Logic rule 9        | See <i>parameter group 13-4* Logic Rules</i> . If logic rule 9 in SLC is true, the output goes high. Otherwise, it is low.  |
| [80]   | SL digital output A | See <i>parameter 13-52 SL Controller Action</i> . Output A is low on smart logic action [32] <i>Set digital out A low</i> . Output A is high on smart logic action [38].                      |
| [81]   | SL digital output B | See <i>parameter 13-52 SL Controller Action</i> . Output B is low on smart logic action [33] <i>Set digital out B low</i> . Output B is high on smart logic action [39].                      |
| [82]   | SL digital output C | See <i>parameter 13-52 SL Controller Action</i> . Output C is low on smart logic action [34] <i>Set digital out C low</i> . Output C is high on smart logic action [40].                      |
| [83]   | SL digital output D | See <i>parameter 13-52 SL Controller 1 Action</i> . Output D is low on smart logic action [35] <i>Set digital out D low</i> . Output D is high on smart logic action [41].                    |
| [84]   | SL digital output E | See <i>parameter 13-52 SL Controller Action</i> . Output E is low on smart logic action [36] <i>Set digital out E low</i> . Output E is high on smart logic action [42].                      |
| [85]   | SL digital output F | See <i>parameter 13-52 SL Controller Action</i> . Output F is low on smart logic action [37] <i>Set digital out F low</i> . Output F is high on smart logic action [43].                      |
| [90]   | kWh counter pulse   |   |
| [96]   | Reverse after ramp  | <p style="text-align: center;"><b>NOTICE</b></p> <p>This option is only available with software version 48.XX.</p> <p>See the description in <i>parameter group 5-3* Digital Outputs</i>.</p> |
| [98]   | Virtual master dir. | <p style="text-align: center;"><b>NOTICE</b></p> <p>This option is only available with software version 48.XX.</p> <p>See the description in <i>parameter group 5-3* Digital Outputs</i>.</p> |
| [120]  | Local ref active    | Output is high when <i>parameter 3-13 Reference Site = [2] Local</i> or when <i>parameter 3-13 Reference Site = [0] Linked</i> to hand auto at the same time as the LCP is in hand-on mode.   |

Table 361: Local Reference Active

| Reference site set in <i>parameter 3-13 Reference Site</i>             | Local reference active [120] | Remote reference active [121] |
|--|------------------------------|-------------------------------|
| Reference site: Local <i>parameter 3-13 Reference Site [2] Local</i>   | 1                            | 0                             |
| Reference site: Remote <i>parameter 3-13 Reference Site [1] Remote</i> | 0                            | 1                             |
| Reference site: Linked to Hand/ Auto                                   |                              |                               |
| Hand   | 1                            | 0                             |
| Hand⇒off   | 1                            | 0                             |
| Auto⇒off   | 0                            | 0                             |
| Auto   | 0                            | 1                             |

| Option | Name                   | Description   |
|--------|------------------------|---|
| [121]  | Remote ref active      | Output is high when <i>parameter 3-13 Reference Site</i> = [1] Remote or [0] Linked to hand/auto while the LCP.   |
| [122]  | No alarm               | Output is high when no alarm is present.  |
| [123]  | Start command active   | Output is high when the start command is high (that is via digital input, bus connection, [Hand On], or [Auto On]), and a stop has been the last command.                               |
| [124]  | Running reverse        | Output is high when the drive is running counterclockwise (the logical product of the status bits running AND reverse).   |
| [125]  | Drive in hand mode     | Output is high when the drive is in hand-on mode (as indicated by the LED light above [Hand On]).   |
| [126]  | Drive in auto mode     | Output is high when the drive is in auto-on mode (as indicated by LED light on above [Auto On]).  |
| [151]  | ATEX ETR cur. alarm    | Selectable if <i>parameter 1-90 Motor Thermal Protection</i> is set to [20] ATEX ETR or [21] Advanced ETR. If <i>alarm 164, ATEX ETR cur.lim.alarm</i> is active, the output is 1.      |
| [152]  | ATEX ETR freq. alarm   | Selectable if <i>parameter 1-90 Motor Thermal Protection</i> is set to [20] ATEX ETR or [21] Advanced ETR. If <i>alarm 166, ATEX ETR freq.lim.alarm</i> is active, the output is 1.     |
| [153]  | ATEX ETR cur. warning  | Selectable if <i>parameter 1-90 Motor Thermal Protection</i> is set to [20] ATEX ETR or [21] Advanced ETR. If <i>alarm 163, ATEX ETR cur.lim.warning</i> is active, the output is 1.    |
| [154]  | ATEX ETR freq. warning | Selectable if <i>parameter 1-90 Motor Thermal Protection</i> is set to [20] ATEX ETR or [21] Advanced ETR. If <i>warning 165, ATEX ETR freq.lim.warning</i> is active, the output is 1. |
| [173]  | 10Wh counter pulse     |   |
| [178]  | RS Flipflop 8          | See <i>parameter group 13-1* Comparators</i> .  |
| [179]  | RS Flipflop 9          | See <i>parameter group 13-1* Comparators</i> .  |
| [180]  | Clock fault            |   |
| [181]  | Prev. Maintenance      |   |
| [188]  | AHF Capacitor Connect  |   |
| [189]  | External Fan Control   | The internal logics for the internal fan control is transferred to this output to make it possible to control an external fan (relevant for hp duct cooling).                           |
| [190]  | Safe Function active   |   |
| [191]  | Safe Opt. Reset req.   |   |
| [192]  | RS Flipflop 0          | See <i>parameter group 13-1* Comparators</i> .  |
| [193]  | RS Flipflop 1          | See <i>parameter group 13-1* Comparators</i> .  |
| [194]  | RS Flipflop 2          | See <i>parameter group 13-1* Comparators</i> .  |
| [195]  | RS Flipflop 3          | See <i>parameter group 13-1* Comparators</i> .  |
| [196]  | RS Flipflop 4          | See <i>parameter group 13-1* Comparators</i> .  |
| [197]  | RS Flipflop 5          | See <i>parameter group 13-1* Comparators</i> .  |
| [198]  | RS Flipflop 6          | See <i>parameter group 13-1* Comparators</i> .  |

| Option | Name               | Description   |
|--------|--------------------|---|
| [199]  | RS Flipflop 7      | See <i>parameter group 13-1* Comparators</i> .  |
| [221]  | IGBT-cooling       | Use this option for handling the overcurrent trips. When the drive detects an overcurrent condition, it shows <i>alarm 13, Overcurrent</i> and triggers a reset. If the overcurrent condition occurs 3 times in a row, the drive shows <i>alarm 13, Overcurrent</i> and initiates a 3 minute delay before the next reset.   |
| [222]  | Homing OK          | <p style="text-align: center;"><b>NOTICE</b></p> <p>This option is available only with software version 48.XX.</p> <p>Homing is completed with the selected homing function (<i>parameter 17-80 Homing Function</i>).</p>   |
| [223]  | On target          | <p style="text-align: center;"><b>NOTICE</b></p> <p>This option is available only with software version 48.XX.</p> <p>Positioning is completed and the on target signal is sent when the actual position is within <i>parameter 3-05 On Reference Window</i> for the duration of <i>parameter 3-09 On Target Time</i> and the actual speed does not exceed <i>parameter 3-05 On Reference Window</i>.</p> |
| [224]  | Position limit     | <p style="text-align: center;"><b>NOTICE</b></p> <p>This option is available only with software version 48.XX.</p> <p>The position error exceeds the value in <i>parameter 4-71 Maximum Position Error</i> for the time set in <i>parameter 4-72 Position Error Timeout</i>.</p>  |
| [225]  | Position error     | <p style="text-align: center;"><b>NOTICE</b></p> <p>This option is available only with software version 48.XX.</p> <p>The position is outside the limits set in <i>parameter 3-06 Minimum Position</i> and <i>parameter 3-07 Maximum Position</i>.</p>  |
| [226]  | Touch on target    | <p style="text-align: center;"><b>NOTICE</b></p> <p>This option is available only with software version 48.XX.</p> <p>Target position is reached in touch probe position mode.</p>  |
| [227]  | Touch activated    | <p style="text-align: center;"><b>NOTICE</b></p> <p>This option is available only with software version 48.XX.</p> <p>Touch probe positioning active. The drive monitors the touch probe sensor input.</p>  |
| [228]  | Touch sensor found | <p style="text-align: center;"><b>NOTICE</b></p> <p>This option is available only with software version 48.XX.</p> <p>The touch sensor has been detected.</p>   |

| Option | Name                    | Description   |
|--------|-------------------------|---|
| [229]  | Vir. master on ref.     | <p style="text-align: center;"><b>NOTICE</b></p> <p>This option is available only with software version 48.XX.</p> <p>The virtual master is running on the set reference.</p>                               |
| [231]  | In power lim. mot.      | <p style="text-align: center;"><b>NOTICE</b></p> <p>This option is only available in FC 302.</p>  |
| [232]  | In power lim. gen.      | <p style="text-align: center;"><b>NOTICE</b></p> <p>This option is only available in FC 302.</p>  |
| [233]  | In power limit          | <p style="text-align: center;"><b>NOTICE</b></p> <p>This option is only available in FC 302.</p>  |
| [234]  | PE power off            |   |
| [246]  | Emcy mode was act.      | The drive has been operating in emergency mode.   |
| [247]  | Emergency mode          | The drive is operating in emergency mode. See <i>parameter group 24-0* Emergency Mode</i> .   |
| [249]  | Emcy m. OPR un-expected | Emergency mode is not operating as expected, for example, live zero monitoring on an analog input is activated.   |
| [250]  | Emcy mode limits        | During emergency mode operation, 1 of the critical alarms has been activated and suppressed by emergency mode. This may lead to reduced drive performance and expected lifetime before service is required. |
| [254]  | Testing emcy mode       | Emergency mode was activated in a special test mode where the drive stops on all alarms.  |

## Parameter 5-41 On Delay, Relay

Table 362: Parameter 5-41 On Delay, Relay

| 5-41 On Delay, Relay  |  |                               |
|-----------------------|--|-------------------------------|
| Default value: 0.01 s | Parameter type: Range, 0.01 – 600 s, Array [9] | Setup: All setups             |
| Conversion index: -2  | Data type: Uint16                              | Change during operation: True |

Enter the delay of the relay cut in time. Select 1 of 2 internal mechanical relays in an array function. See *parameter 5-40 Function Relay* for details.



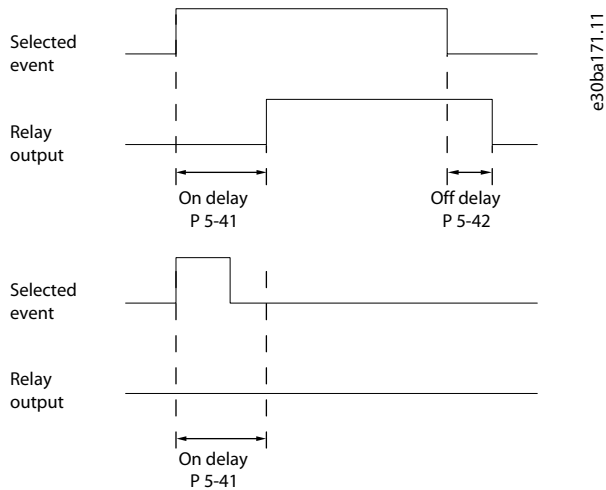

Illustration 63: On Delay, Relay

Parameter 5-42 Off Delay, Relay

Table 363: Parameter 5-42 Off Delay, Relay

| 5-42 Off Delay, Relay |  |                               |
|-----------------------|--|-------------------------------|
| Default value: 0.01 s | Parameter type: Range, 0.01 – 600 s, Array [9] | Setup: All setups             |
| Conversion index: -2  | Data type: Uint16                              | Change during operation: True |

Enter the delay of the relay cutout time. Select 1 of 2 internal mechanical relays in an array function. See *parameter 5-40 Function Relay* for details. If the selected event condition changes before a delay timer expires, the relay output is unaffected.

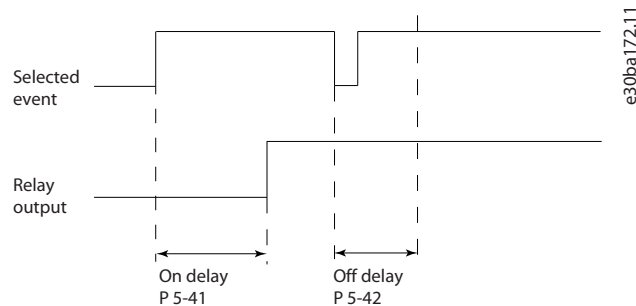

Illustration 64: Off Delay, Relay

5.6.5 5-5\* Pulse Input

**NOTICE**

The following parameters are only available in FC 302:

- Parameter 5-50 Term. 29 Low Frequency
- Parameter 5-51 Term. 29 High Frequency
- Parameter 5-52 Term. 29 Low Ref./Feedb. Value
- Parameter 5-53 Term. 29 High Ref./Feedb. Value
- Parameter 5-54 Pulse Filter Time Constant #29

The pulse input parameters are used to define an appropriate window for the impulse reference area by configuring the scaling and filter settings for the pulse inputs. Input terminals 29 or 33 act as frequency reference inputs. Set terminal 29 (*parameter 5-13 Terminal 29 Digital Input*) or terminal 33 (*parameter 5-15 Terminal 33 Digital Input*) to [32] Pulse input. If terminal 29 is used as an input, set *parameter 5-01 Terminal 27 Mode* to [0] Input.

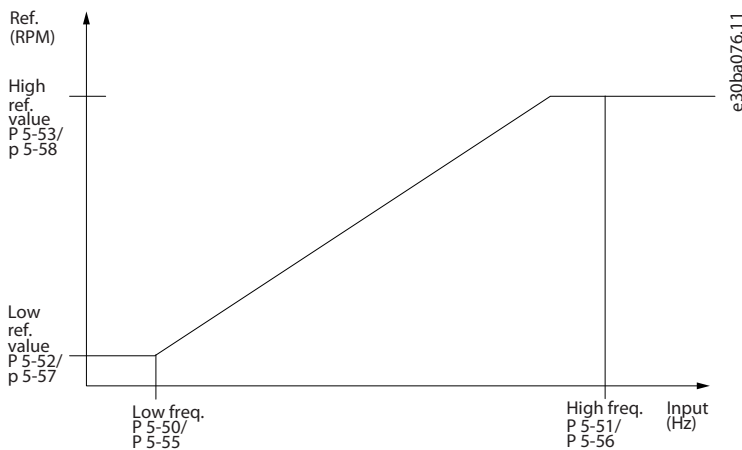

Illustration 65: Pulse Input

Parameter 5-50 Term. 29 Low Frequency

Table 364: Parameter 5-50 Term. 29 Low Frequency

| 5-50 Term. 29 Low Frequency |                                      |                               |
|-----------------------------|--------------------------------------|-------------------------------|
| Default value: 100 Hz       | Parameter type: Range, 0 – 110000 Hz | Setup: All setups             |
| Conversion index: 0         | Data type: Uint32                    | Change during operation: True |

Enter the low frequency limit corresponding to the low motor shaft speed (that is low reference value) in *parameter 5-52 Term. 29 Low Ref./Feedb. Value*. Refer to [Illustration 65](#).

Parameter 5-51 Term. 29 High Frequency

Table 365: Parameter 5-51 Term. 29 High Frequency

| 5-51 Term. 29 High Frequency |                                      |                               |
|------------------------------|--------------------------------------|-------------------------------|
| Default value: Size related  | Parameter type: Range, 0 – 110000 Hz | Setup: All setups             |
| Conversion index: 0          | Data type: Uint32                    | Change during operation: True |

Enter the high frequency limit corresponding to the high motor shaft speed (that is high reference value) in *parameter 5-53 Term. 29 High Ref./Feedb. Value*.

Parameter 5-52 Term. 29 Low Ref./Feedb. Value

Table 366: Parameter 5-52 Term. 29 Low Ref./Feedb. Value

| 5-52 Term. 29 Low Ref./Feedb. Value |  |                               |
|-------------------------------------|--|-------------------------------|
| Default value: Size related         | Parameter type: Range, -999999.999 - 999999.999 Reference- Feed-backUnit | Setup: All setups             |
| Conversion index: -3                | Data type: Int32   | Change during operation: True |

Enter the low reference value limit for the motor shaft speed [RPM]. This is also the lowest feedback value, see also *parameter 5-57 Term. 33 Low Ref./Feedb. Value*. Set terminal 29 to digital input (*parameter 5-02 Terminal 29 Mode = [0] Input* (default) and *parameter 5-13 Terminal 29 Digital Input = applicable value*).

Parameter 5-53 Term. 29 High Ref./Feedb. Value

Table 367: Parameter 5-53 Term. 29 High Ref./Feedb. Value

| 5-53 Term. 29 High Ref./Feedb. Value |  |                               |
|--------------------------------------|--|-------------------------------|
| Default value: Size related          | Parameter type: Range, -999999.999 - 999999.999 Reference- Feed-backUnit | Setup: All setups             |
| Conversion index: -3                 | Data type: Int32   | Change during operation: True |

Enter the high reference value [RPM] for the motor shaft speed and the high feedback value, see also *parameter 5-58 Term. 33 High Ref./Feedb. Value*. Select terminal 29 as a digital input (*parameter 5-02 Terminal 29 Mode = [0] Input* (default) and *parameter 5-13 Terminal 29 Digital Input = applicable* value).

Parameter 5-54 Pulse Filter Time Constant #29

Table 368: Parameter 5-54 Pulse Filter Time Constant #29

| 5-54 Pulse Filter Time Constant #29 |                                    |                                |
|-------------------------------------|------------------------------------|--------------------------------|
| Default value: 100 ms               | Parameter type: Range, 1 - 1000 ms | Setup: All setups              |
| Conversion index: -3                | Data type: Uint16                  | Change during operation: False |

Enter the pulse filter time constant. The pulse filter dampens oscillations of the feedback signal. If there is much noise in the system this is an advantage. A high time constant value results in better dampening but also increases the time delay through the filter.

Parameter 5-55 Term. 33 Low Frequency

Table 369: Parameter 5-55 Term. 33 Low Frequency

| 5-55 Term. 33 Low Frequency |                                      |                               |
|-----------------------------|--------------------------------------|-------------------------------|
| Default value: 100 Hz       | Parameter type: Range, 0 - 110000 Hz | Setup: All setups             |
| Conversion index: 0         | Data type: Uint32                    | Change during operation: True |

Enter the low frequency corresponding to the low motor shaft speed (that is low reference value) in *parameter 5-57 Term. 33 Low Ref./Feedb. Value*.

Parameter 5-56 Term. 33 High Frequency

Table 370: Parameter 5-56 Term. 33 High Frequency

| 5-56 Term. 33 High Frequency |                                      |                               |
|------------------------------|--------------------------------------|-------------------------------|
| Default value: Size related  | Parameter type: Range, 0 - 110000 Hz | Setup: All setups             |
| Conversion index: 0          | Data type: Uint32                    | Change during operation: True |

Enter the high frequency corresponding to the high motor shaft speed (that is high reference value) in *parameter 5-58 Term. 33 High Ref./Feedb. Value*.

Parameter 5-57 Term. 33 Low Ref./Feedb. Value

Table 371: Parameter 5-57 Term. 33 Low Ref./Feedb. Value

| 5-57 Term. 33 Low Ref./Feedb. Value |  |                               |
|-------------------------------------|--|-------------------------------|
| Default value: Size related         | Parameter type: Range, -999999.999 - 999999.999 ReferenceFeed-backUnit | Setup: All setups             |
| Conversion index: -3                | Data type: Int32   | Change during operation: True |

Enter the low reference value [RPM] for the motor shaft speed. This is also the low feedback value, see also *parameter 5-52 Term. 29 Low Ref./Feedb. Value*.

Parameter 5-58 Term. 33 High Ref./Feedb. Value

Table 372: Parameter 5-58 Term. 33 High Ref./Feedb. Value

| 5-58 Term. 33 High Ref./Feedb. Value |  |                               |
|--------------------------------------|--|-------------------------------|
| Default value: Size related          | Parameter type: Range, -999999.999 - 999999.999 ReferenceFeed-backUnit | Setup: All setups             |
| Conversion index: -3                 | Data type: Int32   | Change during operation: True |

Enter the high reference value [RPM] for the motor shaft speed. See also *parameter 5-53 Term. 29 High Ref./Feedb. Value*.  
Parameter 5-59 Pulse Filter Time Constant #33

Table 373: Parameter 5-59 Pulse Filter Time Constant #33

| 5-59 Pulse Filter Time Constant #33 |                                    |                                |
|-------------------------------------|------------------------------------|--------------------------------|
| Default value: 100 ms               | Parameter type: Range, 1 - 1000 ms | Setup: All setups              |
| Conversion index: -3                | Data type: Uint16                  | Change during operation: False |

**NOTICE**

This parameter cannot be adjusted while the motor is running.

Enter the pulse filter time constant. The low-pass filter reduces the influence and dampens oscillations on the feedback signal from the control. This is an advantage if there is a lot of noise in the system.

### 5.6.6 5-6\* Pulse Outputs

**NOTICE**

These parameters cannot be adjusted while the motor is running.

**NOTICE**

The following parameters are only available in FC 302:

- *Parameter 5-63 Terminal 29 Pulse Output Variable*
- *Parameter 5-65 Pulse Output Max Freq #29*

These parameters configure pulse outputs with their functions and scaling. Terminals 27 and 29 are allocated to pulse output via *parameter 5-01 Terminal 27 Mode* and *parameter 5-02 Terminal 29 Mode*, respectively.

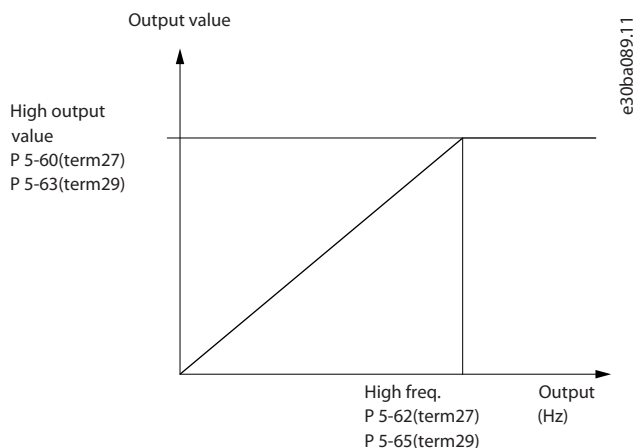

Illustration 66: Configuration of Pulse Outputs

Table 374: Options for Readout Output Variables

| Option | Name                     | Description   |
|--------|--------------------------|---|
|        |                          | Parameters for configuring the scaling and output functions of pulse outputs. The pulse outputs are designated to terminals 27 or 29. Select terminal 27 output in <i>parameter 5-01 Terminal 27 Mode</i> and terminal 29 output in <i>parameter 5-02 Terminal 29 Mode</i> .  |
| [0]    | No operation             |   |
| [45]   | Bus control              |   |
| [48]   | Bus control timeout      |   |
| [51]   | MCO-controlled           |   |
| [97]   | Reference after ramp     | <p style="text-align: center;"><b>NOTICE</b></p> <p>This option is available only with software version 48.XX.</p> <p>Actual speed reference after the ramp. Use this output as master signal for speed synchronization of follower drives. The reference is set in <i>parameter 16-48 Speed Ref. After Ramp [RPM]</i>.</p> |
| [99]   | Virtual master speed     | <p style="text-align: center;"><b>NOTICE</b></p> <p>This option is only available with software version 48.XX.</p> <p>Virtual master signal for controlling the speed or position the followers.</p>  |
| [100]  | Output frequency         |   |
| [101]  | Reference                |   |
| [102]  | Feedback                 |   |
| [103]  | Motor current            |   |
| [104]  | Torque relative to limit |   |
| [105]  | Torque relative to rated |   |
| [106]  | Power                    |   |
| [107]  | Speed                    |   |
| [108]  | Torque                   |   |
| [109]  | Max. out freq            |   |

Parameter 5-60 Terminal 27 Pulse Output Variable

Table 375: Parameter 5-60 Terminal 27 Pulse Output Variable

| 5-60 Terminal 27 Pulse Output Variable |                        |                               |
|--|------------------------|-------------------------------|
| Default value: Size related            | Parameter type: Option | Setup: All setups             |
| Conversion index: –                    | Data type: Uint8       | Change during operation: True |

| Option | Name                    | Description   |
|--------|-------------------------|---|
| [0]    | No operation            | Select the display output for terminal 27.  |
| [45]   | Bus ctrl.               |   |
| [48]   | Bus ctrl., timeout      |   |
| [51]   | MCO controlled          |   |
| [97]   | Reference after ramp    | <p style="text-align: center;"><b>NOTICE</b></p> <p>This option is only available with software version 48.XX.</p> <p>Actual speed reference after the ramp. Use this output as master signal for speed synchronization of follower drives. The reference is set in <i>parameter 16-48 Speed Ref. After Ramp [RPM]</i>.</p> |
| [99]   | Virtual master speed    | <p style="text-align: center;"><b>NOTICE</b></p> <p>This option is only available with software version 48.XX.</p> <p>Virtual master signal for controlling the speed or position of the followers.</p>   |
| [100]  | Output frequency        |   |
| [101]  | Reference               |   |
| [102]  | Feedback                |   |
| [103]  | Motor current           |   |
| [104]  | Torque rel to limit     |   |
| [105]  | Torque related to rated |   |
| [106]  | Power                   |   |
| [107]  | Speed                   |   |
| [108]  | Torque                  |   |
| [109]  | Max out freq            |   |
| [119]  | Torque % lim            |   |

Parameter 5-62 Pulse Output Max Freq #27

Table 376: Parameter 5-62 Pulse Output Max Freq #27

| 5-62 Pulse Output Max Freq #27 |                                      |                               |
|--------------------------------|--------------------------------------|-------------------------------|
| Default value: Size related    | Parameter type: Range, 0 - 110000 Hz | Setup: All setups             |
| Conversion index: 0            | Data type: Uint32                    | Change during operation: True |

Set the maximum frequency for terminal 27 corresponding to the output variable selected in *parameter 5-60 Terminal 27 Pulse Output Variable*.

## Parameter 5-63 Terminal 29 Pulse Output Variable

Table 377: Parameter 5-63 Terminal 29 Pulse Output Variable

| 5-63 Terminal 29 Pulse Output Variable |                        |                               |
|--|------------------------|-------------------------------|
| Default value: Size related            | Parameter type: Option | Setup: All setups             |
| Conversion index: –                    | Data type: Uint8       | Change during operation: True |

| Option | Name                    | Description   |
|--------|-------------------------|---|
| [0]    | No operation            | Select the display output for terminal 27.  |
| [45]   | Bus ctrl.               |   |
| [48]   | Bus ctrl., timeout      |   |
| [51]   | MCO controlled          |   |
| [97]   | Reference after ramp    | <p style="text-align: center;"><b>NOTICE</b></p> <p>This option is only available with software version 48.XX.</p> <p>Actual speed reference after the ramp. Use this output as master signal for speed synchronization of follower drives. The reference is set in <i>parameter 16-48 Speed Ref. After Ramp [RPM]</i>.</p> |
| [99]   | Virtual master speed    | <p style="text-align: center;"><b>NOTICE</b></p> <p>This option is only available with software version 48.XX.</p> <p>Virtual master signal for controlling the speed or position of the followers.</p>   |
| [100]  | Output frequency        |   |
| [101]  | Reference               |   |
| [102]  | Feedback                |   |
| [103]  | Motor current           |   |
| [104]  | Torque rel to limit     |   |
| [105]  | Torque related to rated |   |
| [106]  | Power                   |   |
| [107]  | Speed                   |   |
| [108]  | Torque                  |   |
| [109]  | Max out freq            |   |
| [119]  | Torque % lim            |   |

## Parameter 5-65 Pulse Output Max Freq #29

Table 378: Parameter 5-65 Pulse Output Max Freq #29

| 5-65 Pulse Output Max Freq #29 |                                      |                               |
|--------------------------------|--------------------------------------|-------------------------------|
| Default value: Size related    | Parameter type: Range, 0 - 110000 Hz | Setup: All setups             |
| Conversion index: 0            | Data type: Uint32                    | Change during operation: True |

Set the maximum frequency for terminal 29 corresponding to the output variable selected in *parameter 5-63 Terminal 29 Pulse Output Variable*.

Parameter 5-66 Terminal X30/6 Pulse Output Variable

Table 379: Parameter 5-66 Terminal X30/6 Pulse Output Variable

| 5-66 Terminal X30/6 Pulse Output Variable |                        |                               |
|---|------------------------|-------------------------------|
| Default value: Size related               | Parameter type: Option | Setup: All setups             |
| Conversion index: –                       | Data type: Uint8       | Change during operation: True |

Select the variable for readout on terminal X30/6. This parameter is active when VLT® General Purpose I/O MCB 101 is installed in the drive. The options and functions are the same as in *parameter group 5-6\* Pulse Outputs*.

| Option | Name                    | Description   |
|--------|-------------------------|---|
| [0]    | No operation            | Select the display output for terminal 27.  |
| [45]   | Bus ctrl.               |   |
| [48]   | Bus ctrl., timeout      |   |
| [51]   | MCO controlled          |   |
| [97]   | Reference after ramp    | <p style="text-align: center;"><b>NOTICE</b></p> <p>This option is only available with software version 48.XX.</p> <p>Actual speed reference after the ramp. Use this output as master signal for speed synchronization of follower drives. The reference is set in <i>parameter 16-48 Speed Ref. After Ramp [RPM]</i>.</p> |
| [99]   | Virtual master speed    | <p style="text-align: center;"><b>NOTICE</b></p> <p>This option is only available with software version 48.XX.</p> <p>Virtual master signal for controlling the speed or position of the followers.</p>   |
| [100]  | Output frequency        |   |
| [101]  | Reference               |   |
| [102]  | Feedback                |   |
| [103]  | Motor current           |   |
| [104]  | Torque rel to limit     |   |
| [105]  | Torque related to rated |   |
| [106]  | Power                   |   |
| [107]  | Speed                   |   |
| [108]  | Torque                  |   |
| [109]  | Max out freq            |   |
| [119]  | Torque % lim            |   |



Parameter 5-68 Pulse Output Max Freq #30/6

Table 380: Parameter 5-68 Pulse Output Max Freq #30/6

| 5-68 Pulse Output Max Freq #30/6 |                                      |                               |
|----------------------------------|--------------------------------------|-------------------------------|
| Default value: Size related      | Parameter type: Range, 0 - 110000 Hz | Setup: All setups             |
| Conversion index: 0              | Data type: Uint32                    | Change during operation: True |

**NOTICE**

This parameter cannot be changed while the motor is running.

Set the maximum frequency on terminal X30/6 referring to the output variable selected in *parameter 5-66 Terminal X30/6 Pulse Output Variable*. This parameter is active when VLT® General Purpose I/O MCB 101 is installed in the drive.

### 5.6.7 5-7\* 24 V Encoder Input

Connect the 24 V encoder to terminal 12 (24 V DC supply), terminal 32 (channel A), terminal 33 (channel B), and terminal 20 (GND). The digital inputs 32/33 are active for encoder inputs when [1] 24 V encoder is selected in *parameter 1-02 Flux Motor Feedback Source* and *parameter 7-00 Speed PID Feedback Source*. The encoder used is a dual-channel (A and B) 24 V type. Maximum input frequency: 110 kHz.

#### Encoder connection to the drive

24 V incremental encoder. Maximum cable length is 5 m (16.4 ft).

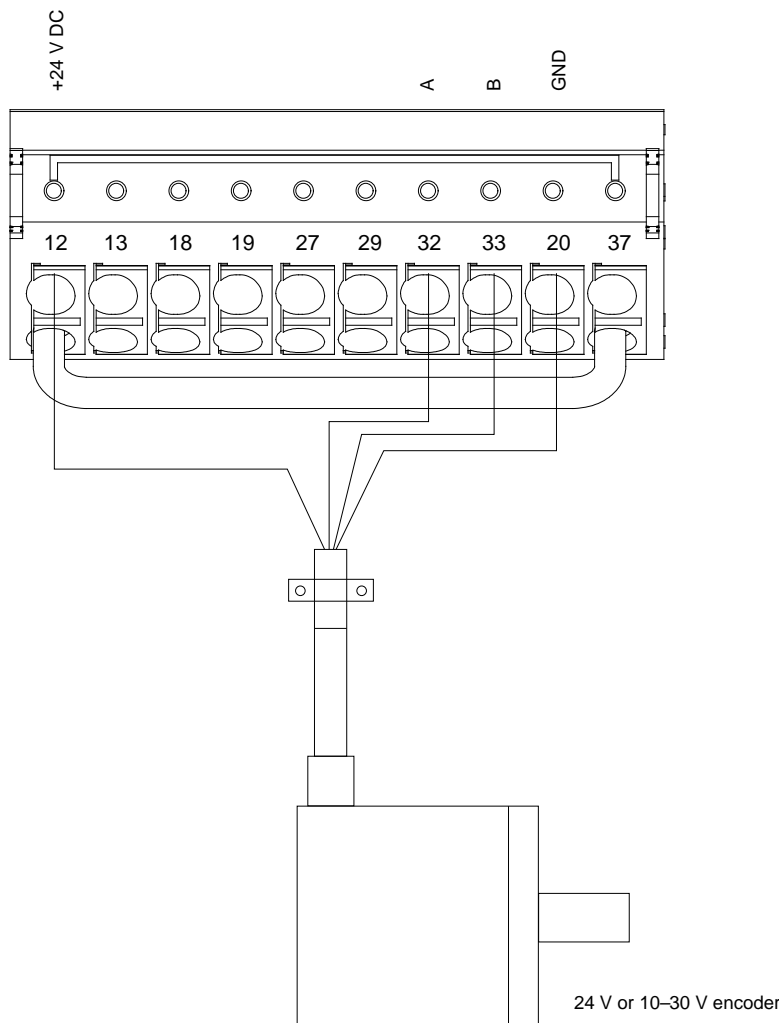

e30ba090.12

Illustration 67: Encoder Connection

e30ba646.10

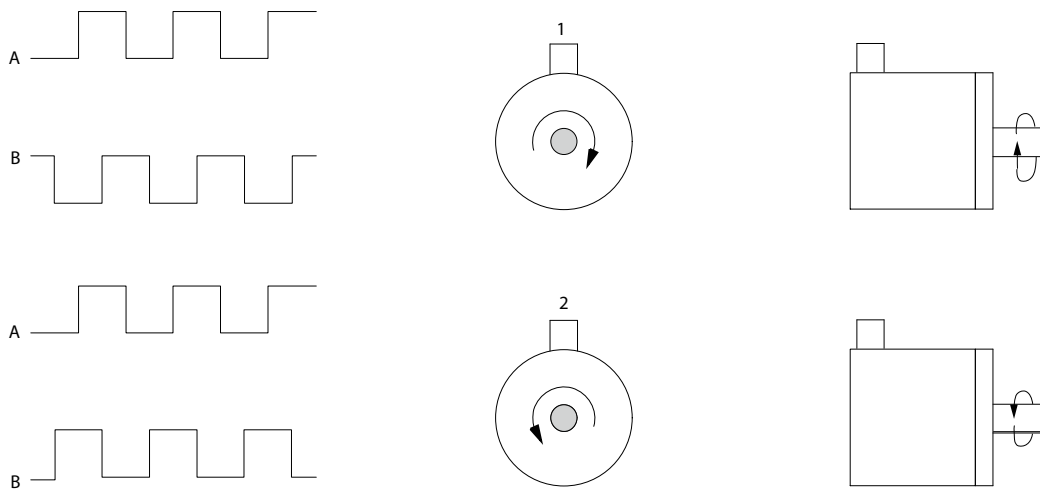

Illustration 68: Encoder Rotation Direction

Parameter 5-70 Term 32/33 Pulses Per Revolution

Table 381: Parameter 5-70 Term 32/33 Pulses Per Revolution

| 5-70 Term 32/33 Pulses Per Revolution |                                 |                                |
|---------------------------------------|---------------------------------|--------------------------------|
| Default value: 1024                   | Parameter type: Range, 1 - 4096 | Setup: All setups              |
| Conversion index: 0                   | Data type: Uint16               | Change during operation: False |

Set the resolution of the encoder connected to terminal 32/33 in pulses per revolution.

Parameter 5-71 Term 32/33 Encoder Direction

Table 382: Parameter 5-71 Term 32/33 Encoder Direction

| 5-71 Term 32/33 Encoder Direction |                        |                                |
|-----------------------------------|------------------------|--------------------------------|
| Default value: [0] Clockwise      | Parameter type: Option | Setup: All setups              |
| Conversion index: –               | Data type: Uint8       | Change during operation: False |

**NOTICE**

This parameter cannot be adjusted while the motor is running.

Change the detected encoder rotation direction without changing the wiring to the encoder.

| Option | Name              | Description  |
|--------|-------------------|--|
| [0]*   | Clockwise         | Sets channel A 90° (electrical degrees) behind channel B upon clockwise rotation of the encoder shaft.   |
| [1]    | Counter clockwise | Sets channel A 90° (electrical degrees) ahead of channel B upon clockwise rotation of the encoder shaft. |

Parameter 5-72 Term 32/33 Encoder Type

Table 383: Parameter 5-72 Term 32/33 Encoder Type

| 5-72 Term 32/33 Encoder Type             |                        |                                |
|--|------------------------|--------------------------------|
| Default value: [0] Quadrature A/B format | Parameter type: Option | Setup: All setups              |
| Conversion index: –                      | Data type: Uint8       | Change during operation: False |

**NOTICE**

This parameter is only available with software version 48.XX.

Select the signal type of the encoder connected to terminals 32, 33.

| Option | Name                  | Description   |
|--------|-----------------------|---|
| [0]*   | Quadrature A/B format | Encoder with 2 tracks: A and B, displaced 90° for detecting the rotational direction.   |
| [1]    | Single channel 33     | Encoder with 1 track connected to terminal 33.  |
| [2]    | Single channel w/dir. | Encoder with 1 track connected to terminal 33. The direction is set with a signal on terminal 32: 0 V = forward/clockwise, 24 V = reverse/counterclockwise. |

Parameter 5-75 Term 27/29 Pulses Per Revolution

Table 384: Parameter 5-75 Term 27/29 Pulses Per Revolution

| 5-75 Term 27/29 Pulses Per Revolution |                                 |                                |
|---------------------------------------|---------------------------------|--------------------------------|
| Default value: 1024                   | Parameter type: Range, 1 - 4096 | Setup: All setups              |
| Conversion index: 0                   | Data type: Uint16               | Change during operation: False |

Set the resolution of the encoder connected to terminal 27/29 in pulses per revolution.

Parameter 5-76 Term 27/29 Encoder Direction

Table 385: Parameter 5-76 Term 27/29 Encoder Direction

| 5-76 Term 27/29 Encoder Direction |                        |                                |
|-----------------------------------|------------------------|--------------------------------|
| Default value: [0] Clockwise      | Parameter type: Option | Setup: All setups              |
| Conversion index: -               | Data type: Uint8       | Change during operation: False |

**NOTICE**

This parameter cannot be adjusted while the motor is running.

Change the detected encoder rotation direction without changing the wiring to the encoder.

| Option | Name              | Description  |
|--------|-------------------|--|
| [0]*   | Clockwise         | Sets channel A 90° (electrical degrees) behind channel B upon clockwise rotation of the encoder shaft.   |
| [1]    | Counter clockwise | Sets channel A 90° (electrical degrees) ahead of channel B upon clockwise rotation of the encoder shaft. |

Parameter 5-77 Term 27/29 Encoder Type

Table 386: Parameter 5-77 Term 27/29 Encoder Type

| 5-77 Term 27/29 Encoder Type             |                        |                                |
|--|------------------------|--------------------------------|
| Default value: [0] Quadrature A/B format | Parameter type: Option | Setup: All setups              |
| Conversion index: -                      | Data type: Uint8       | Change during operation: False |

**NOTICE**

This parameter is only available with software version 48.XX.

Select the signal type of the encoder connected to terminals 27, 29.

| Option | Name                  | Description   |
|--------|-----------------------|---|
| [0]*   | Quadrature A/B format | Encoder with 2 tracks: A and B, displaced 90° for detecting the rotational direction.   |
| [1]    | Single channel 33     | Encoder with 1 track connected to terminal 29.  |
| [2]    | Single channel w/dir. | Encoder with 1 track connected to terminal 29. The direction is set with a signal on terminal 32: 0 V = forward/clockwise, 24 V = reverse/counterclockwise. |

## Parameter 5-78 Term 27/29 Encoder Sim

Table 387: Parameter 5-78 Term 27/29 Encoder Sim

| 5-78 Term 27/29 Encoder Sim        |                        |                                |
|------------------------------------|------------------------|--------------------------------|
| Default value: [1] Actual position | Parameter type: Option | Setup: All setups              |
| Conversion index: –                | Data type: Uint8       | Change during operation: False |

Select the source for generation of the encoder simulation output. To enable 24 V encoder simulation on terminal 27/29, set *parameter 5-30 Terminal 27 Digital Output* and *parameter 5-31 Terminal 29 Digital Output* to [54] 24V Encoder Sim.

| Op-tion | Name                 | Description  |
|---------|----------------------|--|
| [1]*    | Actual position      | The encoder simulation is a mirror of the actual position. The output is scaled by <i>parameter 5-75 Term 27/29 Pulses Per Revolution</i> related to 1 motor revolution. One motor revolution is represented by the number of pulses set in <i>parameter 5-75 Term 27/29 Pulses Per Revolution</i> . This means that 1 motor revolution is represented by the number of pulses set in <i>parameter 5-75 Term 27/29 Pulses Per Revolution</i> .   |
| [2]     | Commanded position   | The encoder simulation is a mirror of the commanded position (position setpoint for the position PI controller). The output is scaled by <i>parameter 5-75 Term 27/29 Pulses Per Revolution</i> related to 1 motor revolution. This means that 1 motor revolution is represented by the number of pulses set in <i>parameter 5-75 Term 27/29 Pulses Per Revolution</i> .   |
| [3]     | Vir. master position | The encoder simulation is generated by the virtual master function. The output is scaled by <i>parameter 5-75 Term 27/29 Pulses Per Revolution</i> . Virtual master speed reference can be set by fieldbus REF 1 or the source selected in <i>parameter 3-16 Reference Resource 2</i> relative to <i>parameter 3-27 Virtual Master Max Ref</i> . Example: With <i>parameter 3-27 Virtual Master Max Ref</i> = 50 Hz and a reference of 50% the output corresponds to a master speed of $50 \text{ Hz} * 60/\text{min} * 50\% = 1500 \text{ RPM}$ . The pulse frequency will be <i>parameter 5-75 Term 27/29 Pulses Per Revolution</i> , for example, $1024 * 1500 \text{ RPM} / 60 = 25.6 \text{ kHz}$ . Speed of the individual followers is determined by their scaling in <i>parameter 3-22 Master Scale Numerator</i> , <i>parameter 3-23 Master Scale Denominator</i> , <i>parameter 17-72 Position Unit Numerator</i> , and <i>parameter 17-73 Position Unit Denominator</i> . |
| [4]     | 24V encoder 32/33    | The encoder simulation is a mirror of the encoder signal on terminal 32/33. The drive can be used as repeater.   |

## 5.6.8 5-8\* I/O Options

## NOTICE

This parameter group is only available in FC 302.

## Parameter 5-80 AHF Cap Reconnect Delay

Table 388: Parameter 5-80 AHF Cap Reconnect Delay

| 5-80 AHF Cap Reconnect Delay |                                  |                               |
|------------------------------|----------------------------------|-------------------------------|
| Default value: 25 s          | Parameter type: Range, 1 - 120 s | Setup: 2 setups               |
| Conversion index: 0          | Data type: Uint16                | Change during operation: True |

Guarantees a minimum off-time for the capacitors. The timer starts once the AHF capacitor disconnects and has to expire before the output is allowed to be on again. It only turns on again if the drive power is 20–30%.

### 5.6.9 5-9\* Bus-controlled

#### N O T I C E

The following parameters are only available in FC 302:

- *Parameter 5-95 Pulse Out #29 Bus Control*
- *Parameter 5-96 Pulse Out #29 Timeout Preset*

This parameter group selects digital and relay outputs via a fieldbus setting.

#### Parameter 5-90 Digital & Relay Bus Control

**Table 389: Parameter 5-90 Digital & Relay Bus Control**

| 5-90 Digital & Relay Bus Control |                                       |                               |
|----------------------------------|---------------------------------------|-------------------------------|
| Default value: 0                 | Parameter type: Range, 0 - 0xFFFFFFFF | Setup: All setups             |
| Conversion index: 0              | Data type: Uint32                     | Change during operation: True |

This parameter holds the state of the digital outputs and relays that is controlled by bus. A logical 1 indicates that the output is high or active. A logical 0 indicates that the output is low or inactive.

**Table 390: Bus-controlled Digital Outputs and Relays**

| Bit  | Output/Relay                     |
|------|----------------------------------|
| 0    | Digital output terminal 27       |
| 1    | Digital output terminal 29       |
| 2    | Digital output terminal X30/6    |
| 3    | Digital output terminal X30/7    |
| 4    | Relay 1 output terminal          |
| 5    | Relay 2 output terminal          |
| 6    | Option B relay 1 output terminal |
| 7    | Option B relay 2 output terminal |
| 8    | Option B relay 3 output terminal |
| 9-15 | Reserved for future terminals    |
| 16   | Option C relay 1 output terminal |
| 17   | Option C relay 2 output terminal |
| 18   | Option C relay 3 output terminal |
| 19   | Option C relay 4 output terminal |
| 20   | Option C relay 5 output terminal |
| 21   | Option C relay 6 output terminal |

| Bit   | Output/Relay                     |
|-------|----------------------------------|
| 22    | Option C relay 7 output terminal |
| 23    | Option C relay 8 output terminal |
| 21–31 | Reserved for future terminals    |

## Parameter 5-93 Pulse Out #27 Bus Control

Table 391: Parameter 5-93 Pulse Out #27 Bus Control

| 5-93 Pulse Out #27 Bus Control |                                 |                               |
|--------------------------------|---------------------------------|-------------------------------|
| Default value: 0%              | Parameter type: Range, 0 - 100% | Setup: All setups             |
| Conversion index: -2           | Data type: N2                   | Change during operation: True |

Set the output frequency transferred to output terminal 27 when the terminal is configured as [45] *Bus Controlled* in parameter 5-60 *Terminal 27 Pulse Output Variable*.

## Parameter 5-94 Pulse Out #27 Timeout Preset

Table 392: Parameter 5-94 Pulse Out #27 Timeout Preset

| 5-94 Pulse Out #27 Timeout Preset |                                 |                               |
|-----------------------------------|---------------------------------|-------------------------------|
| Default value: 0%                 | Parameter type: Range, 0 - 100% | Setup: 1 setup                |
| Conversion index: -2              | Data type: Uint16               | Change during operation: True |

Set the output frequency transferred to output terminal 27 when the terminal is configured as [48] *Bus Ctrl Timeout* in parameter 5-60 *Terminal 27 Pulse Output Variable* and a timeout is detected.

## Parameter 5-95 Pulse Out #29 Bus Control

Table 393: Parameter 5-95 Pulse Out #29 Bus Control

| 5-95 Pulse Out #29 Bus Control |                                 |                               |
|--------------------------------|---------------------------------|-------------------------------|
| Default value: 0%              | Parameter type: Range, 0 - 100% | Setup: All setups             |
| Conversion index: -2           | Data type: N2                   | Change during operation: True |

Set the output frequency transferred to output terminal 29 when the terminal is configured as [45] *Bus Controlled* in parameter 5-63 *Terminal 29 Pulse Output Variable*.

## Parameter 5-96 Pulse Out #29 Timeout Preset

Table 394: Parameter 5-96 Pulse Out #29 Timeout Preset

| 5-96 Pulse Out #29 Timeout Preset |                                 |                               |
|-----------------------------------|---------------------------------|-------------------------------|
| Default value: 0%                 | Parameter type: Range, 0 - 100% | Setup: 1 setup                |
| Conversion index: -2              | Data type: Uint16               | Change during operation: True |

Set the output frequency transferred to output terminal 29 when the terminal is configured as [48] *Bus Ctrl Timeout* in parameter 5-63 *Terminal 29 Pulse Output Variable* and a timeout is detected.

## Parameter 5-97 Pulse Out #X30/6 Bus Control

Table 395: Parameter 5-97 Pulse Out #30/6 Bus Control

| 5-97 Pulse Out #30/6 Bus Control |                                 |                               |
|----------------------------------|---------------------------------|-------------------------------|
| Default value: 0%                | Parameter type: Range, 0 - 100% | Setup: All setups             |
| Conversion index: -2             | Data type: N2                   | Change during operation: True |

Set the output frequency transferred to output terminal X30/6 when the terminal is configured as [45] *Bus ctrl.* in parameter 5-66 *Terminal X30/6 Pulse Output Variable*.

Parameter 5-98 Pulse Out #X30/6 Timeout Preset

**Table 396: Parameter 5-98 Pulse Out #30/6 Timeout Preset**

| 5-98 Pulse Out #30/6 Timeout Preset |                                 |                               |
|-------------------------------------|---------------------------------|-------------------------------|
| Default value: 0%                   | Parameter type: Range, 0 - 100% | Setup: 1 setup                |
| Conversion index: -2                | Data type: Uint16               | Change during operation: True |

Set the output frequency transferred to output terminal X30/6 when the terminal is configured as [48] *Bus Ctrl Timeout* in parameter 5-66 *Terminal X30/6 Pulse Output Variable* and a timeout is detected.

## 5.7 Parameter Group 6-\*\* Analog In/Out

### 5.7.1 6-0\* Analog I/O Mode

The analog inputs can be allocated to be either voltage (FC 301: 0–10 V, FC 302: 0 to ±10 V) or current input (0/4–20 mA).

#### N O T I C E

Thermistors may be connected to either an analog or a digital input.

Parameter 6-00 Live Zero Timeout Time

**Table 397: Parameter 6-00 Live Zero Timeout Time**

| 6-00 Live Zero Timeout Time |                                 |                               |
|-----------------------------|---------------------------------|-------------------------------|
| Default value: 10 s         | Parameter type: Range, 0 - 99 s | Setup: All setup              |
| Conversion index: 0         | Data type: Int16                | Change during operation: True |

Enter the live zero timeout in s. Live zero timeout time is active for analog inputs, that is terminal 53 or terminal 54, used as reference or feedback sources. If the reference signal value associated with the selected current input drops below 50% of the value set in:

- *Parameter 6-10 Terminal 53 Low Voltage*
- *Parameter 6-12 Terminal 53 Low Current*
- *Parameter 6-20 Terminal 54 Low Voltage*
- *Parameter 6-22 Terminal 54 Low Current*

for a time period longer than the time set in parameter 6-00 *Live Zero Timeout Time*, the function selected in parameter 6-01 *Live Zero Timeout Function* is activated.

Parameter 6-01 Live Zero Timeout Function

**Table 398: Parameter 6-01 Live Zero Timeout Function**

| 6-01 Live Zero Timeout Function |                        |                               |
|---------------------------------|------------------------|-------------------------------|
| Default value: [0] Off          | Parameter type: Option | Setup: All setups             |
| Conversion index: –             | Data type: Uint8       | Change during operation: True |

Select the timeout function. If the input signal on terminal 53 or 54 is below 50% of the value in

- *Parameter 6-10 Terminal 53 Low Voltage*
- *Parameter 6-12 Terminal 53 Low Current*
- *Parameter 6-20 Terminal 54 Low Voltage*
- *Parameter 6-22 Terminal 54 Low Current*

for a time period defined in *parameter 6-00 Live Zero Timeout Time*, then the function set in *parameter 6-01 Live Zero Timeout Function* is activated. If several timeouts occur simultaneously, the drive prioritizes the timeout functions as follows:

- *Parameter 6-01 Live Zero Timeout Function*
- *Parameter 8-04 Control Word Timeout Function*

| Option | Name           | Description                             |
|--------|----------------|---|
| [0]*   | Off            |   |
| [1]    | Freeze output  | Frozen at the present value.            |
| [2]    | Stop           | Overruled to stop.                      |
| [3]    | Jogging        | Overruled to jog speed.                 |
| [4]    | Max. speed     | Overruled to maximum speed.             |
| [5]    | Stop and trip  | Overruled to stop with subsequent trip. |
| [20]   | Coast          |   |
| [21]   | Coast and trip |   |

#### Parameter 6-02 Emergency Mode Live Zero Timeout Function

Table 399: Parameter 6-02 Emergency Mode Live Zero Timeout Function

| 6-02 Emergency Mode Live Zero Timeout Function |                        |                               |
|--|------------------------|-------------------------------|
| Default value: [0] Off                         | Parameter type: Option | Setup: All setups             |
| Conversion index: –                            | Data type: Uint8       | Change during operation: True |

Select the timeout function when emergency mode is active. The function set in this parameter is activated if the input signal on analog inputs is below 50% of the low value for a period defined in *parameter 6-00 Live Zero Timeout Time*.

| Option | Name          | Description                  |
|--------|---------------|------------------------------|
| [0]*   | Off           |                              |
| [1]    | Freeze output | Frozen at the present value. |
| [2]    | Stop          | Overruled to stop.           |
| [3]    | Jogging       | Overruled to jog speed.      |
| [4]    | Max. speed    | Overruled to maximum speed.  |

### 5.7.2 6-1\* Analog Input 1

Parameters for configuring the scaling and limits for analog input 1 (terminal 53).



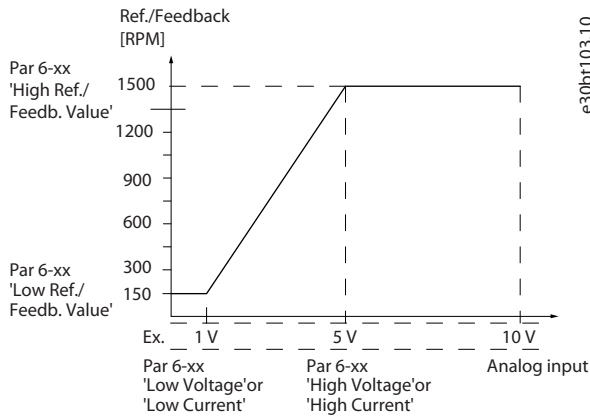

Illustration 69: Analog Input 1

Parameter 6-10 Terminal 53 Low Voltage

Table 400: Parameter 6-10 Terminal 53 Low Voltage

| 6-10 Terminal 53 Low Voltage |   |                               |
|------------------------------|---|-------------------------------|
| Default value: Size related  | Parameter type: Range, -10.00 - par. 6-11 V | Setup: All setups             |
| Conversion index: -2         | Data type: Int16                            | Change during operation: True |

Enter the low voltage value. This analog input scaling value should correspond to the minimum reference value set in *parameter 6-14 Terminal 53 Low Ref./Feedb. Value*.

Parameter 6-11 Terminal 53 High Voltage

Table 401: Parameter 6-11 Terminal 53 High Voltage

| 6-11 Terminal 53 High Voltage |   |                               |
|-------------------------------|---|-------------------------------|
| Default value: 10 V           | Parameter type: Range, par. 6-10 V - 10 V | Setup: All setups             |
| Conversion index: -2          | Data type: Int16                          | Change during operation: True |

Enter the high voltage value. This analog input scaling value should correspond to the high reference feedback value set in *parameter 6-15 Terminal 53 High Ref./Feedb. Value*.

Parameter 6-12 Terminal 53 Low Current

Table 402: Parameter 6-12 Terminal 53 Low Current

| 6-12 Terminal 53 Low Current |  |                               |
|------------------------------|--|-------------------------------|
| Default value: 0.14 mA       | Parameter type: Range, par. 0 - par. 6-13 mA | Setup: All setups             |
| Conversion index: -5         | Data type: Int16                             | Change during operation: True |

Enter the low current value. This reference signal should correspond to the minimum reference value, set in *parameter 3-02 Minimum Reference*. Set the value to exceed 2 mA to activate the live zero timeout function in *parameter 6-01 Live Zero Timeout Function*.

Parameter 6-13 Terminal 53 High Current

Table 403: Parameter 6-13 Terminal 53 High Current

| 6-13 Terminal 53 High Current |  |                               |
|-------------------------------|--|-------------------------------|
| Default value: 20 mA          | Parameter type: Range, par. par. 6-12 mA - 20 mA | Setup: All setups             |
| Conversion index: -5          | Data type: Int16                                 | Change during operation: True |

Enter the high current value corresponding to the high reference/feedback set in *parameter 6-15 Terminal 53 High Ref./Feedb. Value*.

## Parameter 6-14 Terminal 53 Low Ref./Feedb. Value

Table 404: Parameter 6-14 Terminal 53 Low Ref./Feedb. Value

| 6-14 Terminal 53 Low Ref./Feedb. Value |  |                               |
|--|--|-------------------------------|
| Default value: Size related            | Parameter type: Range, -999999.999 - 999999.999 ReferenceFeed-backUnit | Setup: All setups             |
| Conversion index: -3                   | Data type: Int32   | Change during operation: True |

Enter the analog input scaling value that corresponds to the low voltage/low current set in *parameter 6-10 Terminal 53 Low Voltage* and *parameter 6-12 Terminal 53 Low Current*.

## Parameter 6-15 Terminal 53 High Ref./Feedb. Value

Table 405: Parameter 6-15 Terminal 53 High Ref./Feedb. Value

| 6-15 Terminal 53 High Ref./Feedb. Value |  |                               |
|---|--|-------------------------------|
| Default value: Size related             | Parameter type: Range, -999999.999 - 999999.999 ReferenceFeed-backUnit | Setup: All setups             |
| Conversion index: -3                    | Data type: Int32   | Change during operation: True |

Enter the analog input scaling value that corresponds to the maximum reference feedback value set in *parameter 6-11 Terminal 53 High Voltage* and *parameter 6-13 Terminal 53 High Current*.

## Parameter 6-16 Terminal 53 Filter Time Constant

Table 406: Parameter 6-16 Terminal 53 Filter Time Constant

| 6-16 Terminal 53 Filter Time Constant |                                     |                               |
|---------------------------------------|-------------------------------------|-------------------------------|
| Default value: 0.001 s                | Parameter type: Range, 0.001 - 10 s | Setup: All setups             |
| Conversion index: -3                  | Data type: Uint16                   | Change during operation: True |

## NOTICE

This parameter cannot be adjusted while the motor is running.

Enter the filter time constant. This constant is a first-order digital low-pass filter time for suppressing electrical noise in terminal 53. A high value improves dampening but also increases the delay through the filter.

### 5.7.3 6-2\* Analog Input 2

Parameters for configuring the scaling and limits for analog input 2 (terminal 54).

## Parameter 6-20 Terminal 54 Low Voltage

Table 407: Parameter 6-20 Terminal 54 Low Voltage

| 6-20 Terminal 54 Low Voltage |   |                               |
|------------------------------|---|-------------------------------|
| Default value: Size related  | Parameter type: Range, -10.00 - par. 6-21 V | Setup: All setups             |
| Conversion index: -2         | Data type: Int16                            | Change during operation: True |

Enter the low voltage value. This analog input scaling value should correspond to the minimum reference value set in *parameter 3-02 Minimum Reference*.

## Parameter 6-21 Terminal 54 High Voltage

Table 408: Parameter 6-21 Terminal 54 High Voltage

| 6-21 Terminal 54 High Voltage |   |                               |
|-------------------------------|---|-------------------------------|
| Default value: 10 V           | Parameter type: Range, par. 6-20 V - 10 V | Setup: All setups             |
| Conversion index: -2          | Data type: Int16                          | Change during operation: True |

Enter the high voltage value. This analog input scaling value should correspond to the high reference feedback value set in *parameter 6-25 Terminal 54 High Ref./Feedb. Value*.

## Parameter 6-22 Terminal 54 Low Current

Table 409: Parameter 6-22 Terminal 54 Low Current

| 6-22 Terminal 54 Low Current |  |                               |
|------------------------------|--|-------------------------------|
| Default value: Size related  | Parameter type: Range, par. 0 - par. 6-23 mA | Setup: All setups             |
| Conversion index: -5         | Data type: Int16                             | Change during operation: True |

Enter the low current value. This reference signal should correspond to the minimum reference value, set in *parameter 3-02 Minimum Reference*. Enter the value that exceeds 2 mA to activate the live zero timeout function in *parameter 6-01 Live Zero Timeout Function*.

## Parameter 6-23 Terminal 54 High Current

Table 410: Parameter 6-23 Terminal 54 High Current

| 6-23 Terminal 54 High Current |  |                               |
|-------------------------------|--|-------------------------------|
| Default value: 20 mA          | Parameter type: Range, par. par. 6-22 mA - 20 mA | Setup: All setups             |
| Conversion index: -5          | Data type: Int16                                 | Change during operation: True |

Enter the high current value corresponding to the high reference feedback value set in *parameter 6-25 Terminal 54 High Ref./Feedb. Value*.

## Parameter 6-24 Terminal 54 Low Ref./Feedb. Value

Table 411: Parameter 6-24 Terminal 54 Low Ref./Feedb. Value

| 6-24 Terminal 54 Low Ref./Feedb. Value |  |                               |
|--|--|-------------------------------|
| Default value: Size related            | Parameter type: Range, -999999.999 - 999999.999 ReferenceFeed-backUnit | Setup: All setup              |
| Conversion index: -3                   | Data type: Int32   | Change during operation: True |

Enter the analog input scaling value that corresponds to the minimum reference feedback value set in *parameter 3-02 Minimum Reference*.

## Parameter 6-25 Terminal 54 High Ref./Feedb. Value

Table 412: Parameter 6-25 Terminal 54 High Ref./Feedb. Value

| 6-25 Terminal 54 High Ref./Feedb. Value |  |                               |
|---|--|-------------------------------|
| Default value: Size related             | Parameter type: Range, -999999.999 - 999999.999 ReferenceFeed-backUnit | Setup: All setups             |
| Conversion index: -3                    | Data type: Int32   | Change during operation: True |

Enter the analog input scaling value that corresponds to the maximum reference feedback value set in *parameter 3-03 Maximum Reference*.

## Parameter 6-26 Terminal 54 Filter Time Constant

Table 413: Parameter 6-26 Terminal 54 Filter Time Constant

| 6-26 Terminal 54 Filter Time Constant |                                     |                               |
|---------------------------------------|-------------------------------------|-------------------------------|
| Default value: 0.001 s                | Parameter type: Range, 0.001 - 10 s | Setup: All setups             |
| Conversion index: -3                  | Data type: Uint16                   | Change during operation: True |

## N O T I C E

This parameter cannot be adjusted while the motor is running.

Enter the filter time constant. This is a first-order digital low-pass filter time constant for suppressing electrical noise in terminal 54. Increasing the value improves dampening but also increases the time delay through the filter.

### 5.7.4 6-3\* Analog Input 3 General Purpose I/O MCB 101

Parameter group for configuring the scale and limits for analog input 3 (X30/11) in VLT® General Purpose I/O MCB 101.

## Parameter 6-30 Terminal X30/11 Low Voltage

Table 414: Parameter 6-30 Terminal X30/11 Low Voltage

| 6-30 Terminal X30/11 Low Voltage |   |                               |
|----------------------------------|---|-------------------------------|
| Default value: Size related      | Parameter type: Range, -10.00 - par. 6-31 V | Setup: All setups             |
| Conversion index: -2             | Data type: Int16                            | Change during operation: True |

Sets the analog input scaling value to correspond to the low reference feedback value (set in *parameter 6-34 Term. X30/11 Low Ref./Feedb. Value*).

## Parameter 6-31 Terminal X30/11 High Voltage

Table 415: Parameter 6-31 Terminal X30/11 High Voltage

| 6-31 Terminal X30/11 High Voltage |   |                               |
|-----------------------------------|---|-------------------------------|
| Default value: 10 V               | Parameter type: Range, par. 6-30 V - 10 V | Setup: All setups             |
| Conversion index: -2              | Data type: Int16                          | Change during operation: True |

Sets the analog input scaling value to correspond to the high reference feedback value (set in *parameter 6-35 Term. X30/11 High Ref./Feedb. Value*).

## Parameter 6-34 Term. X30/11 Low Ref./Feedb. Value

Table 416: Parameter 6-34 Term. X30/11 Low Ref./Feedb. Value

| 6-34 Term. X30/11 Low Ref./Feedb. Value |  |                               |
|---|--|-------------------------------|
| Default value: Size related             | Parameter type: Range, -999999.999 - 999999.999 ReferenceFeed-backUnit | Setup: All setup              |
| Conversion index: -3                    | Data type: Int32   | Change during operation: True |

Sets the analog input scaling value to correspond to the low voltage value (set in *parameter 6-30 Terminal X30/11 Low Voltage*).

Parameter 6-35 Term. X30/11 High Ref./Feedb. Value

Table 417: Parameter 6-35 Term. X30/11 High Ref./Feedb. Value

| 6-35 Term. X30/11 High Ref./Feedb. Value |  |                               |
|--|--|-------------------------------|
| Default value: Size related              | Parameter type: Range, -999999.999 - 999999.999 ReferenceFeed-backUnit | Setup: All setups             |
| Conversion index: -3                     | Data type: Int32   | Change during operation: True |

Sets the analog input scaling value to correspond to the high-voltage value (set in *parameter 6-31 Terminal X30/11 High Voltage*).

Parameter 6-36 Term. X30/11 Filter Time Constant

Table 418: Parameter 6-36 Term. X30/11 Filter Time Constant

| 6-36 Term. X30/11 Filter Time Constant |                                     |                               |
|--|-------------------------------------|-------------------------------|
| Default value: 0.001 s                 | Parameter type: Range, 0.001 - 10 s | Setup: All setups             |
| Conversion index: -3                   | Data type: Uint16                   | Change during operation: True |

## N O T I C E

This parameter cannot be adjusted while the motor is running.

Enter the filter time constant. This is a first-order digital low-pass filter time constant for suppressing electrical noise in terminal X30/11. Increasing the value improves dampening but also increases the time delay through the filter.

### 5.7.5 6-4\* Analog Input X30/12

Parameter group for configuring the scale and limits for analog input 4 (X30/12) in VLT® General Purpose I/O MCB 101.

Parameter 6-40 Terminal X30/12 Low Voltage

Table 419: Parameter 6-40 Terminal X30/12 Low Voltage

| 6-40 Terminal X30/12 Low Voltage |   |                               |
|----------------------------------|---|-------------------------------|
| Default value: Size related      | Parameter type: Range, -10.00 - par. 6-41 V | Setup: All setups             |
| Conversion index: -2             | Data type: Int16                            | Change during operation: True |

Sets the analog input scaling value to correspond to the low reference feedback value set in *parameter 6-44 Term. X30/12 Low Ref./Feedb. Value*.

Parameter 6-41 Terminal X30/12 High Voltage

Table 420: Parameter 6-41 Terminal X30/12 High Voltage

| 6-41 Terminal X30/12 High Voltage |   |                               |
|-----------------------------------|---|-------------------------------|
| Default value: 10 V               | Parameter type: Range, par. 6-40 V - 10 V | Setup: All setups             |
| Conversion index: -2              | Data type: Int16                          | Change during operation: True |

Sets the analog input scaling value to correspond to the high reference feedback value set in *parameter 6-45 Term. X30/12 High Ref./Feedb. Value*.

Parameter 6-44 Term. X30/12 Low Ref./Feedb. Value

Table 421: Parameter 6-44 Term. X30/12 Low Ref./Feedb. Value

| 6-44 Term. X30/12 Low Ref./Feedb. Value |  |                               |
|---|--|-------------------------------|
| Default value: Size related             | Parameter type: Range, -999999.999 - 999999.999 ReferenceFeed-backUnit | Setup: All setup              |
| Conversion index: -3                    | Data type: Int32   | Change during operation: True |

Sets the analog output scaling value to correspond to the low voltage value set in *parameter 6-40 Terminal X30/12 Low Voltage*.

Parameter 6-45 Term. X30/12 High Ref./Feedb. Value

Table 422: Parameter 6-45 Term. X30/12 High Ref./Feedb. Value

| 6-45 Term. X30/12 High Ref./Feedb. Value |  |                               |
|--|--|-------------------------------|
| Default value: Size related              | Parameter type: Range, -999999.999 - 999999.999 ReferenceFeed-backUnit | Setup: All setups             |
| Conversion index: -3                     | Data type: Int32   | Change during operation: True |

Sets the analog input scaling value to correspond to the high voltage value set in *parameter 6-41 Terminal X30/12 High Voltage*.

Parameter 6-46 Term. X30/12 Filter Time Constant

Table 423: Parameter 6-46 Term. X30/12 Filter Time Constant

| 6-46 Term. X30/12 Filter Time Constant |                                     |                               |
|--|-------------------------------------|-------------------------------|
| Default value: 0.001 s                 | Parameter type: Range, 0.001 - 10 s | Setup: All setups             |
| Conversion index: -3                   | Data type: Uint16                   | Change during operation: True |

## NOTICE

This parameter cannot be adjusted while the motor is running.

Enter the filter time constant. This is a first-order digital low-pass filter time constant for suppressing electrical noise in terminal X30/12. Increasing the value improves dampening but also increases the time delay through the filter.

### 5.7.6 6-5\* Analog Output 1

Parameters for configuring the scaling and limits for analog output 1, that is terminal 42. Analog outputs are current outputs of 0/4–20 mA. Common terminal (terminal 39) is the same terminal and has the same electrical potential for analog common and digital common connection. The resolution on analog output is 12 bit.

Parameter 6-50 Terminal 42 Output

Table 424: Parameter 6-50 Terminal 42 Output

| 6-50 Terminal 42 Output         |                        |                               |
|---------------------------------|------------------------|-------------------------------|
| Default value: [0] No operation | Parameter type: Option | Setup: All setups             |
| Conversion index: –             | Data type: Uint8       | Change during operation: True |

Select the function of terminal 42 as an analog current output. Depending on the selection, the output is either a 0–20 mA or 4–20 mA output. The current value can be read out in the LCP in *parameter 16-65 Analog Output 42 [mA]*.

| Option | Name         | Description                               |
|--------|--------------|---|
| [0]*   | No operation | Indicates no signal on the analog output. |
| [52]   | MCO          |   |
| [53]   | MCO 4–20mA   |   |

| Option | Name                       | Description  |
|--------|----------------------------|--|
| [58]   | Actual position            | <p style="text-align: center;"><b>NOTICE</b></p> <p>This option is available only with software version 48.XX.</p> <p>The actual position. 0–20 mA corresponds to <i>parameter 3-06 Minimum Position</i> to <i>parameter 3-07 Maximum Position</i>.</p>  |
| [59]   | Actual position<br>4–20 mA | <p style="text-align: center;"><b>NOTICE</b></p> <p>This option is available only with software version 48.XX.</p> <p>The actual position. 4–20 mA corresponds to <i>parameter 3-06 Minimum Position</i> to <i>parameter 3-07 Maximum Position</i>.</p>  |
| [100]  | Output frequency           | 0 Hz = 0 mA; 100 Hz = 20 mA.   |
| [101]  | Reference                  | <i>Parameter 3-00 Reference Range [Min - Max]</i> 0% = 0 mA; 100% = 20 mA<br><i>Parameter 3-00 Reference Range [-Max - Max]</i> -100% = 0 mA; 0% = 10 mA; +100% = 20 mA.   |
| [102]  | Feedback                   |  |
| [103]  | Motor current              | <p>The value is taken from <i>parameter 16-37 Inv. Max. Current</i>. The inverter maximum current (160% current) is equal to 20 mA.</p> <p><b>Example:</b> Inverter normal current (11 kW) is 24 A. 160 %=38.4 A. Motor normal current is 22 A, the readout is 11.46 mA.</p> $\frac{20 \text{ mA} \times 22 \text{ A}}{38.4 \text{ A}} = 11.46 \text{ mA}$ <p>When the normal motor current is equal to 20 mA, the output setting of <i>parameter 6-52 Terminal 42 Output Max Scale</i> is:</p> $\frac{I_{VLT,MAX} \times 100}{I_{Motor,Nom}} = \frac{38.4 \times 100}{22} = 175 \%$ |
| [104]  | Torque rel to limit        | The torque setting is related to the setting in <i>parameter 4-16 Torque Limit Motor Mode</i> .  |
| [105]  | Torque relate to rated     | The torque is related to the motor torque setting.   |
| [106]  | Power                      | Taken from <i>parameter 1-20 Motor Power [kW]</i> .  |
| [107]  | Speed                      | Taken from <i>parameter 3-03 Maximum Reference</i> . 20 mA equals the value in <i>parameter 3-03 Maximum Reference</i> .   |
| [108]  | Torque                     | Torque reference related to 160% torque.   |
| [109]  | Max out freq               | 0 Hz = 0 mA, <i>parameter 4-19 Max Output Frequency</i> = 20 mA.   |
| [113]  | PID clamped output         |  |
| [119]  | Torque % lim               |  |
| [123]  | Speed both dir             |  |

| Option | Name                   | Description   |
|--------|------------------------|---|
| [124]  | Speed both dir 4–20 mA |   |
| [130]  | Output freq. 4–20mA    | 0 Hz = 4 mA, 100 Hz = 20 mA.  |
| [131]  | Reference 4–20mA       | <i>Parameter 3-00 Reference Range [Min-Max]</i> 0% = 4 mA; 100% = 20 mA<br><i>Parameter 3-00 Reference Range [-Max-Max]</i> -100% = 4 mA; 0% = 12 mA; +100% = 20 mA.  |
| [132]  | Feedback 4–20mA        |   |
| [133]  | Motor cur. 4–20mA      | The value is taken from <i>parameter 16-37 Inv. Max. Current</i> . The inverter maximum current (160% current) is equal to 16 mA. Example: Inverter normal current (11 kW) is 24 A. 160% = 38.4 A. Motor normal current is 22 A, the readout is 13.17 mA.<br><br>$\frac{16 \text{ mA} \times 22 \text{ A}}{38.4 \text{ A}} = 13.17 \text{ mA}$ <p>If the normal motor current is equal to 20 mA, the output setting of <i>parameter 6-52 Terminal 42 Output Max Scale</i> is:</p> $\frac{I_{VLT,MAX} \times 100}{I_{Motor,Nom}} = \frac{38.4 \times 100}{22} = 175\%$ |
| [134]  | Torq.% lim 4–20mA      | The torque setting is related to the setting in <i>parameter 4-16 Torque Limit Motor Mode</i> .   |
| [135]  | Torq.% nom 4–20mA      | The torque setting is related to the motor torque setting.  |
| [136]  | Power 4–20mA           | Taken from <i>parameter 1-20 Motor Power [kW]</i> .   |
| [137]  | Speed 4–20mA           | Taken from <i>parameter 3-03 Maximum Reference</i> . 20 mA = value in <i>parameter 3-03 Maximum Reference</i> .   |
| [138]  | Torque 4–20mA          | Torque reference related to 160% torque.  |
| [139]  | Bus ctrl.              | An output value set from fieldbus process data. The output works independently of internal functions in the drive.  |
| [140]  | Bus ctrl. 4-20mA       | An output value set from fieldbus process data. The output works independently of internal functions in the drive.  |
| [141]  | Bus ctrl t.o.          | <i>Parameter 4-54 Warning Reference Low</i> defines the behavior of the analog output in case of fieldbus timeout.  |
| [142]  | Bus ctrl 4-20mA t.o.   | <i>Parameter 4-54 Warning Reference Low</i> defines the behavior of the analog output in case of fieldbus timeout.  |
| [147]  | Main act val           |   |
| [148]  | Main act val 4-20mA    |   |
| [149]  | Torque % lim 4-20mA    | Analog output at 0 torque is 12 mA. Motoring torque increases the output current to maximum torque limit 20 mA (set in <i>parameter 4-16 Torque Limit Motor Mode</i> ). Generating torque decreases the output to torque limit in generator mode (set in <i>parameter 4-17 Torque Limit Generator Mode</i> )<br>Example: <i>Parameter 4-16 Torque Limit Motor Mode</i> = 200% and <i>parameter 4-17 Torque Limit Generator Mode</i> = 200%. 20 mA = 200% motoring and 4 mA = 200% generating.   |



| Option | Name                  | Description  |
|--------|-----------------------|--|
| [150]  | Max Out Fr<br>4-20mA  | 0 Hz = 0 mA, <i>parameter 4-19 Max Output Frequency</i> = 20 mA. |
| [158]  | Motor Volt.           |  |
| [159]  | Motor Volt.<br>4-20mA |  |

Parameter 6-51 Terminal 42 Output Min Scale

Table 425: Parameter 6-51 Terminal 42 Output Min Scale

| 6-51 Terminal 42 Output Min Scale |                                 |                               |
|-----------------------------------|---------------------------------|-------------------------------|
| Default value: 0%                 | Parameter type: Range, 0 - 200% | Setup: All setups             |
| Conversion index: -2              | Data type: Int16                | Change during operation: True |

Scale for the minimum output (0 mA or 4 mA) of the analog signal at terminal 42. Set the value to be the percentage of the full range of the variable selected in *parameter 6-50 Terminal 42 Output*.

Parameter 6-52 Terminal 42 Output Max Scale

Table 426: Parameter 6-52 Terminal 42 Output Max Scale

| 6-52 Terminal 42 Output Max Scale |                                 |                               |
|-----------------------------------|---------------------------------|-------------------------------|
| Default value: 100%               | Parameter type: Range, 0 - 200% | Setup: All setups             |
| Conversion index: -2              | Data type: Int16                | Change during operation: True |

Scale the maximum output of the selected analog signal at terminal 42. Set the value to the maximum value of the current signal output. Scale the output to give a current lower than 20 mA at full scale; or 20 mA at an output below 100% of the maximum signal value. If 20 mA is the required output current at a value 0–100% of the full-scale output, program the percentage value in the parameter, that is 50% = 20 mA. If a current 4–20 mA is required at maximum output (100%), calculate the percentage value as follows: 20 mA/desired maximum current x 100%

10 mA:  $\frac{20}{10} \times 100 = 200\%$

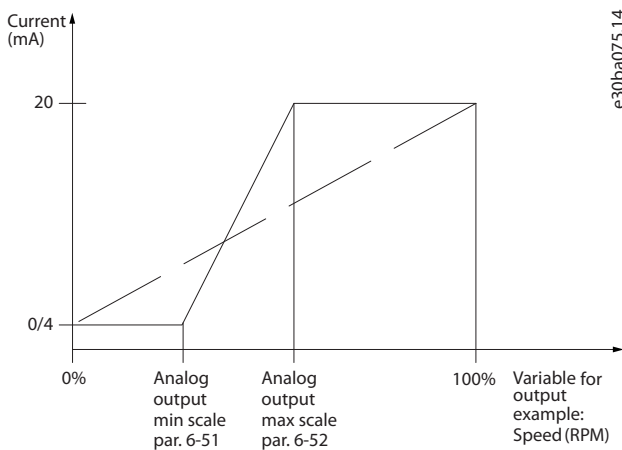

Illustration 70: Output Maximum Scale

## Parameter 6-53 Term 42 Output Bus Ctrl

Table 427: Parameter 6-53 Term 42 Output Bus Ctrl

| 6-53 Term 42 Output Bus Ctrl |                                 |                               |
|------------------------------|---------------------------------|-------------------------------|
| Default value: 0%            | Parameter type: Range, 0 - 100% | Setup: All setups             |
| Conversion index: -2         | Data type: N2                   | Change during operation: True |

Holds the level of output 42 if controlled by bus.

## Parameter 6-54 Term 42 Output Timeout Preset

Table 428: Parameter 6-54 Term 42 Output Timeout Preset

| 6-54 Term 42 Output Timeout Preset |                                 |                               |
|------------------------------------|---------------------------------|-------------------------------|
| Default value: 0%                  | Parameter type: Range, 0 - 100% | Setup: 1 setup                |
| Conversion index: -2               | Data type: Uint16               | Change during operation: True |

Holds the preset level of output 42. If a timeout function is selected in *parameter 6-50 Terminal 42 Output*, the output is preset to this level if a fieldbus timeout occurs.

## Parameter 6-55 Analog Output Filter

Table 429: Parameter 6-55 Analog Output Filter

| 6-55 Analog Output Filter |                        |                               |
|---------------------------|------------------------|-------------------------------|
| Default value: [0] Off    | Parameter type: Option | Setup: 1 setup                |
| Conversion index: -       | Data type: Uint8       | Change during operation: True |

The following readout parameters from selection in *parameter 6-50 Terminal 42 Output* have a filter selected when *parameter 6-55 Analog Output Filter* is on.

Table 430: Readout Parameters

| Selection                    | 0–20 mA | 4–20 mA |
|------------------------------|---------|---------|
| Motor current ( $I_{max}$ )  | [103]   | [133]   |
| Torque limit ( $0-T_{lim}$ ) | [104]   | [134]   |
| Rated torque ( $0-T_{nom}$ ) | [105]   | [135]   |
| Power ( $0-P_{nom}$ )        | [106]   | [136]   |
| Speed ( $0-Speed_{max}$ )    | [107]   | [137]   |

| Option | Name | Description |
|--------|------|-------------|
| [0]*   | Off  | Filter off. |
| [1]    | On   | Filter on.  |

## 5.7.7 6-6\* Analog Output 2 MCB 101

Analog outputs are current outputs: 0/4–20 mA. Common terminal (terminal X30/8) is the same terminal and electrical potential for analog common communication. Resolution on analog output is 12 bit.

Parameter 6-60 Terminal X30/8 Output

Table 431: Parameter 6-60 Terminal X30/8 Output

| 6-60 Terminal X30/8 Output      |                        |                               |
|---------------------------------|------------------------|-------------------------------|
| Default value: [0] No operation | Parameter type: Option | Setup: All setups             |
| Conversion index: –             | Data type: Uint8       | Change during operation: True |

Select the function of terminal X30/8 as an analog current output. Depending on the selection, the output is either a 0–20 mA or 4–20 mA output. The current value can be read out in the LCP in *parameter 16-65 Analog Output 42 [mA]*.

| Option | Name                    | Description  |
|--------|-------------------------|--|
| [0]*   | No operation            | Indicates no signal on the analog output.  |
| [52]   | MCO                     |  |
| [53]   | MCO 4–20mA              |  |
| [58]   | Actual position         | <p style="text-align: center;"><b>NOTICE</b></p> <p>This option is available only with software version 48.XX.</p> <p>The actual position. 0–20 mA corresponds to <i>parameter 3-06 Minimum Position</i> to <i>parameter 3-07 Maximum Position</i>.</p>  |
| [59]   | Actual position 4–20 mA | <p style="text-align: center;"><b>NOTICE</b></p> <p>This option is available only with software version 48.XX.</p> <p>The actual position. 4–20 mA corresponds to <i>parameter 3-06 Minimum Position</i> to <i>parameter 3-07 Maximum Position</i>.</p>  |
| [100]  | Output frequency        | 0 Hz = 0 mA; 100 Hz = 20 mA.   |
| [101]  | Reference               | <i>Parameter 3-00 Reference Range [Min - Max]</i> 0% = 0 mA; 100% = 20 mA<br><i>Parameter 3-00 Reference Range [-Max - Max]</i> -100% = 0 mA; 0% = 10 mA; +100% = 20 mA.   |
| [102]  | Feedback                |  |
| [103]  | Motor current           | <p>The value is taken from <i>parameter 16-37 Inv. Max. Current</i>. The inverter maximum current (160% current) is equal to 20 mA.</p> <p><b>Example:</b> Inverter normal current (11 kW) is 24 A. 160 %=38.4 A. Motor normal current is 22 A, the readout is 11.46 mA.</p> $\frac{20 \text{ mA} \times 22 \text{ A}}{38.4 \text{ A}} = 11.46 \text{ mA}$ <p>When the normal motor current is equal to 20 mA, the output setting of <i>parameter 6-52 Terminal 42 Output Max Scale</i> is:</p> $\frac{I_{VLT,MAX} \times 100}{I_{Motor,Nom}} = \frac{38.4 \times 100}{22} = 175 \%$ |
| [104]  | Torque rel to limit     | The torque setting is related to the setting in <i>parameter 4-16 Torque Limit Motor Mode</i> .  |
| [105]  | Torque relate to rated  | The torque is related to the motor torque setting.   |
| [106]  | Power                   | Taken from <i>parameter 1-20 Motor Power [kW]</i> .  |

| Option | Name                   | Description   |
|--------|------------------------|---|
| [107]  | Speed                  | Taken from <i>parameter 3-03 Maximum Reference</i> . 20 mA equals the value in <i>parameter 3-03 Maximum Reference</i> .  |
| [108]  | Torque                 | Torque reference related to 160% torque.  |
| [109]  | Max out freq           | 0 Hz = 0 mA, <i>parameter 4-19 Max Output Frequency</i> = 20 mA.  |
| [113]  | PID clamped output     |   |
| [117]  | Shaft power            |   |
| [118]  | Shaft power 4–20mA     |   |
| [119]  | Torque % lim           |   |
| [123]  | Speed both dir         |   |
| [124]  | Speed both dir 4–20 mA |   |
| [130]  | Output freq. 4–20mA    | 0 Hz = 4 mA, 100 Hz = 20 mA.  |
| [131]  | Reference 4–20mA       | <i>Parameter 3-00 Reference Range [Min-Max]</i> 0% = 4 mA; 100% = 20 mA<br><i>Parameter 3-00 Reference Range [-Max-Max]</i> -100% = 4 mA; 0% = 12 mA; +100% = 20 mA.  |
| [132]  | Feedback 4–20mA        |   |
| [133]  | Motor cur. 4–20mA      | <p>The value is taken from <i>parameter 16-37 Inv. Max. Current</i>. The inverter maximum current (160% current) is equal to 20 mA. Example: Inverter normal current (11 kW) is 24 A. 160% = 38.4 A. Motor normal current is 22 A, the readout is 11.46 mA.</p> $\frac{16 \text{ mA} \times 22 \text{ A}}{38.4 \text{ A}} = 13.17 \text{ mA}$ <p>If the normal motor current is equal to 20 mA, the output setting of <i>parameter 6-52 Terminal 42 Output Max Scale</i> is:</p> $\frac{I_{VLT, MAX} \times 100}{I_{Motor, Nom}} = \frac{38.4 \times 100}{22} = 175 \%$ |
| [134]  | Torq.% lim 4–20mA      | The torque setting is related to the setting in <i>parameter 4-16 Torque Limit Motor Mode</i> .   |
| [135]  | Torq.% nom 4–20mA      | The torque setting is related to the motor torque setting.  |
| [136]  | Power 4–20mA           | Taken from <i>parameter 1-20 Motor Power [kW]</i> .   |
| [137]  | Speed 4–20mA           | Taken from <i>parameter 3-03 Maximum Reference</i> . 20 mA = value in <i>parameter 3-03 Maximum Reference</i> .   |
| [138]  | Torque 4–20mA          | Torque reference related to 160% torque.  |
| [139]  | Bus ctrl.              | An output value set from fieldbus process data. The output works independently of internal functions in the drive.  |
| [140]  | Bus ctrl. 4–20mA       | An output value set from fieldbus process data. The output works independently of internal functions in the drive.  |

| Option | Name                 | Description   |
|--------|----------------------|---|
| [141]  | Bus ctrl t.o.        | <i>Parameter 4-54 Warning Reference Low</i> defines the behavior of the analog output in case of field-bus timeout.   |
| [142]  | Bus ctrl 4-20mA t.o. | <i>Parameter 4-54 Warning Reference Low</i> defines the behavior of the analog output in case of field-bus timeout.   |
| [147]  | Main act val         |   |
| [148]  | Main act val 4-20mA  |   |
| [149]  | Torque % lim 4-20mA  | Analog output at 0 torque is 12 mA. Motoring torque increases the output current to maximum torque limit 20 mA (set in <i>parameter 4-16 Torque Limit Motor Mode</i> ). Generating torque decreases the output to torque limit in generator mode (set in <i>parameter 4-17 Torque Limit Generator Mode</i> )<br>Example: <i>Parameter 4-16 Torque Limit Motor Mode</i> = 200% and <i>parameter 4-17 Torque Limit Generator Mode</i> = 200%. 20 mA = 200% motoring and 4 mA = 200% generating. |
| [150]  | Max Out Fr 4-20mA    | 0 Hz = 0 mA, <i>parameter 4-19 Max Output Frequency</i> = 20 mA.  |
| [158]  | Motor Volt.          |   |
| [159]  | Motor Volt. 4-20mA   |   |

Parameter 6-61 Terminal X30/8 Min. Scale

Table 432: Parameter 6-61 Terminal X30/8 Min. Scale

| 6-61 Terminal X30/8 Min. Scale |                                 |                               |
|--------------------------------|---------------------------------|-------------------------------|
| Default value: 0%              | Parameter type: Range, 0 - 200% | Setup: All setups             |
| Conversion index: -2           | Data type: Int16                | Change during operation: True |

Scales the minimum output of the selected analog signal on terminal X30/8. Scale the minimum value as a percentage of the maximum signal value. For example, enter the value 25% if the output should be 0 mA at 25% of the maximum output value. The value can never exceed the corresponding setting in *parameter 6-62 Terminal X30/8 Max. Scale* if the value is below 100%. This parameter is active when VLT® General Purpose I/O MCB 101 is mounted in the drive.

Parameter 6-62 Terminal X30/8 Max. Scale

Table 433: Parameter 6-62 Terminal X30/8 Max. Scale

| 6-62 Terminal X30/8 Max. Scale |                                 |                               |
|--------------------------------|---------------------------------|-------------------------------|
| Default value: 100%            | Parameter type: Range, 0 - 200% | Setup: All setups             |
| Conversion index: -2           | Data type: Int16                | Change during operation: True |

Scales the maximum output of the selected analog signal on terminal X30/8. Scale the value to the required maximum value of the current signal output. Scale the output to give a lower current than 20 mA at full scale or 20 mA at an output below 100% of the maximum signal value. If 20 mA is the required output current at a value between 0–100% of the fullscale output, program the percentage value in the parameter, that is 50%=20 mA. If a current 4–20 mA is required at maximum output (100%), calculate the percentage value as follows: 20 mA/desired maximum current x 100%

$$10 \text{ mA} : \frac{20 - 4}{10} \times 100 = 160\%$$

Parameter 6-63 Terminal X30/8 Bus Control

Table 434: Parameter 6-63 Terminal X30/8 Bus Control

| 6-63 Terminal X30/8 Bus Control |                                 |                               |
|---------------------------------|---------------------------------|-------------------------------|
| Default value: 0%               | Parameter type: Range, 0 - 100% | Setup: All setups             |
| Conversion index: -2            | Data type: N2                   | Change during operation: True |

Holds the level of output X30/8 if controlled by bus.  
 Parameter 6-64 Terminal X30/8 Output Timeout Preset

Table 435: Parameter 6-64 Terminal X30/8 Output Timeout Preset

| 6-64 Terminal X30/8 Output Timeout Preset |                                 |                               |
|---|---------------------------------|-------------------------------|
| Default value: 0%                         | Parameter type: Range, 0 - 100% | Setup: 1 setup                |
| Conversion index: -2                      | Data type: Uint16               | Change during operation: True |

Holds the preset level of output X30/8. If a timeout function is selected in *parameter 6-60 Terminal X30/8 Output*, the output is preset to this level if a fieldbus timeout occurs.

### 5.7.8 6-7\* Analog Output 3 MCB 113

Parameters for configuring the scaling and limits for analog output 3, terminals X45/1, and X45/2. Analog outputs are current outputs: 0/4–20 mA. Resolution on analog output is 11 bit.

Parameter 6-70 Terminal X45/1 Output

Table 436: Parameter 6-70 Terminal X45/1 Output

| 6-70 Terminal X45/1 Output      |                        |                               |
|---------------------------------|------------------------|-------------------------------|
| Default value: [0] No operation | Parameter type: Option | Setup: All setups             |
| Conversion index: –             | Data type: Uint8       | Change during operation: True |

Select the function of terminal X45/1 as an analog current output.

| Option | Name             | Description   |
|--------|------------------|---|
| [0]*   | No operation     | Indicates no signal on the analog output.   |
| [52]   | MCO              |   |
| [100]  | Output frequency | 0 Hz = 0 mA; 100 Hz = 20 mA.  |
| [101]  | Reference        | <i>Parameter 3-00 Reference Range [Min - Max]</i> 0% = 0 mA; 100% = 20 mA<br><i>Parameter 3-00 Reference Range [-Max - Max]</i> -100% = 0 mA; 0% = 10 mA; +100% = 20 mA.  |
| [102]  | Feedback         |   |
| [103]  | Motor current    | The value is taken from <i>parameter 16-37 Inv. Max. Current</i> . The inverter maximum current (160% current) is equal to 20 mA.<br><b>Example:</b> Inverter normal current (11 kW) is 24 A. 160 %=38.4 A. Motor normal current is 22 A, the readout is 11.46 mA.<br>$\frac{20 \text{ mA} \times 22 \text{ A}}{38.4 \text{ A}} = 11.46 \text{ mA}$ When the normal motor current is equal to 20 mA, the output setting of <i>parameter 6-52 Terminal 42 Output Max Scale</i> is: |

| Option | Name                   | Description   |
|--------|------------------------|---|
|        |                        | $\frac{I_{VLT,MAX} \times 100}{I_{Motor, Nom}} = \frac{38.4 \times 100}{22} = 175\%$  |
| [104]  | Torque rel to limit    | The torque setting is related to the setting in <i>parameter 4-16 Torque Limit Motor Mode</i> .   |
| [105]  | Torque relate to rated | The torque is related to the motor torque setting.  |
| [106]  | Power                  | Taken from <i>parameter 1-20 Motor Power [kW]</i> .   |
| [107]  | Speed                  | Taken from <i>parameter 3-03 Maximum Reference</i> . 20 mA equals the value in <i>parameter 3-03 Maximum Reference</i> .  |
| [108]  | Torque                 | Torque reference related to 160% torque.  |
| [109]  | Max out freq           | 0 Hz = 0 mA, <i>parameter 4-19 Max Output Frequency</i> = 20 mA.  |
| [113]  | PID clamped output     |   |
| [117]  | Shaft power            |   |
| [118]  | Shaft power 4–20mA     |   |
| [119]  | Torque % lim           |   |
| [123]  | Speed both dir         |   |
| [124]  | Speed both dir 4–20mA  |   |
| [130]  | Output freq. 4–20mA    | 0 Hz = 4 mA, 100 Hz = 20 mA.  |
| [131]  | Reference 4–20mA       | <i>Parameter 3-00 Reference Range [Min-Max]</i> 0% = 4 mA; 100% = 20 mA<br><i>Parameter 3-00 Reference Range [-Max-Max]</i> -100% = 4 mA; 0% = 12 mA; +100% = 20 mA.  |
| [132]  | Feedback 4–20mA        |   |
| [133]  | Motor cur. 4–20mA      | <p>The value is taken from <i>parameter 16-37 Inv. Max. Current</i>. The inverter maximum current (160% current) is equal to 20 mA. Example: Inverter normal current (11 kW) is 24 A. 160% = 38.4 A. Motor normal current is 22 A, the readout is 11.46 mA.</p> $\frac{16 \text{ mA} \times 22 \text{ A}}{38.4 \text{ A}} = 13.17 \text{ mA}$ <p>If the normal motor current is equal to 20 mA, the output setting of <i>parameter 6-52 Terminal 42 Output Max Scale</i> is:</p> $\frac{I_{VLT,MAX} \times 100}{I_{Motor, Nom}} = \frac{38.4 \times 100}{22} = 175\%$ |
| [134]  | Torq.% lim 4–20mA      | The torque setting is related to the setting in <i>parameter 4-16 Torque Limit Motor Mode</i> .   |
| [135]  | Torq.% nom 4–20mA      | The torque setting is related to the motor torque setting.  |
| [136]  | Power 4–20mA           | Taken from <i>parameter 1-20 Motor Power [kW]</i> .   |

| Option | Name                 | Description   |
|--------|----------------------|---|
| [137]  | Speed 4–20mA         | Taken from <i>parameter 3-03 Maximum Reference</i> . 20 mA = value in <i>parameter 3-03 Maximum Reference</i> .   |
| [138]  | Torque 4–20mA        | Torque reference related to 160% torque.  |
| [139]  | Bus ctrl.            | An output value set from fieldbus process data. The output works independently of internal functions in the drive.  |
| [140]  | Bus ctrl. 4–20mA     | An output value set from fieldbus process data. The output works independently of internal functions in the drive.  |
| [141]  | Bus ctrl t.o.        | <i>Parameter 4-54 Warning Reference Low</i> defines the behavior of the analog output in case of fieldbus timeout.  |
| [142]  | Bus ctrl 4-20mA t.o. | <i>Parameter 4-54 Warning Reference Low</i> defines the behavior of the analog output in case of fieldbus timeout.  |
| [147]  | Main act val         |   |
| [148]  | Main act val 4-20mA  |   |
| [149]  | Torque % lim 4-20mA  | Analog output at 0 torque is 12 mA. Motoring torque increases the output current to maximum torque limit 20 mA (set in <i>parameter 4-16 Torque Limit Motor Mode</i> ). Generating torque decreases the output to torque limit in generator mode (set in <i>parameter 4-17 Torque Limit Generator Mode</i> )<br>Example: <i>Parameter 4-16 Torque Limit Motor Mode</i> = 200% and <i>parameter 4-17 Torque Limit Generator Mode</i> = 200%. 20 mA = 200% motoring and 4 mA = 200% generating. |
| [150]  | Max Out Fr 4-20mA    | 0 Hz = 0 mA, <i>parameter 4-19 Max Output Frequency</i> = 20 mA.  |
| [158]  | Motor Volt.          |   |
| [159]  | Motor Volt. 4-20mA   |   |

## Parameter 6-71 Terminal X45/1 Min. Scale

Table 437: Parameter 6-71 Terminal X45/1 Min. Scale

| 6-71 Terminal X45/1 Min. Scale |                                 |                               |
|--------------------------------|---------------------------------|-------------------------------|
| Default value: 0%              | Parameter type: Range, 0 - 200% | Setup: All setups             |
| Conversion index: -2           | Data type: Int16                | Change during operation: True |

Scale the minimum output of the selected analog signal at terminal X45/1 as a percentage of the maximum signal value. For example, if 0 mA (or 0 Hz) is required at 25% of the maximum output value, then program 25%. Scaling values up to 100% can never exceed the corresponding setting in *parameter 6-72 Terminal X45/1 Max. Scale*.

## Parameter 6-72 Terminal X45/1 Max. Scale

Table 438: Parameter 6-72 Terminal X45/1 Max. Scale

| 6-72 Terminal X45/1 Max. Scale |                                 |                               |
|--------------------------------|---------------------------------|-------------------------------|
| Default value: 100%            | Parameter type: Range, 0 - 200% | Setup: All setups             |
| Conversion index: -2           | Data type: Int16                | Change during operation: True |

Scale the maximum output of the selected analog signal at terminal X45/1. Set the value to the maximum value of the current signal output. Scale the output to give a current lower than 20 mA at full scale, or 20 mA at an output below 100% of the maximum signal value. If 20 mA is the required output current at a value between 0–100% of the full-scale output, program the percentage value in



the parameter, for example 50% = 20 mA. If a current 4–20 mA is required at maximum output (100%), calculate the percentage value as follows (example where required maximum output is 10 mA):

$$\frac{I_{\text{RANGE}} [\text{mA}]}{I_{\text{DESIRED MAX}} [\text{mA}]} \times 100 \% = \frac{20 - 4 \text{ mA}}{10 \text{ mA}} \times 100 \% = 160 \%$$

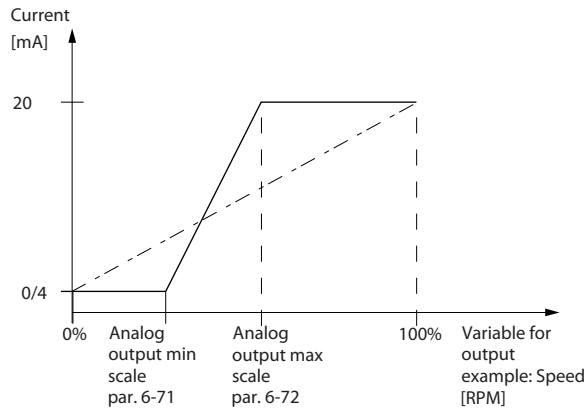

Illustration 71: Output Maximum Scale

Parameter 6-73 Terminal X45/1 Bus Control

Table 439: Parameter 6-73 Terminal X45/1 Bus Control

| 6-73 Terminal X45/1 Bus Control |                                 |                               |
|---------------------------------|---------------------------------|-------------------------------|
| Default value: 0%               | Parameter type: Range, 0 - 100% | Setup: All setups             |
| Conversion index: -2            | Data type: N2                   | Change during operation: True |

Holds the level of analog output 3 (terminal X45/1) if controlled by bus.

Parameter 6-74 Terminal X45/1 Output Timeout Preset

Table 440: Parameter 6-74 Terminal X45/1 Output Timeout Preset

| 6-74 Terminal X45/1 Output Timeout Preset |                                 |                               |
|---|---------------------------------|-------------------------------|
| Default value: 0%                         | Parameter type: Range, 0 - 100% | Setup: 1 setup                |
| Conversion index: -2                      | Data type: Uint16               | Change during operation: True |

Holds the preset level of analog output 3 (terminal X45/1). If there is a fieldbus timeout and a timeout function is selected in parameter 6-70 Terminal X45/1 Output, the output is preset to this level.

5.7.9 6-8\* Analog Output 4 MCB 113

Parameters for configuring the scaling and limits for analog output 4, terminals X45/3 and X45/4. Analog outputs are current outputs: 0/4–20 mA. Resolution on analog output is 11 bit.

Parameter 6-80 Terminal X45/3 Output

Table 441: Parameter 6-80 Terminal X45/3 Output

| 6-80 Terminal X45/3 Output      |                        |                               |
|---------------------------------|------------------------|-------------------------------|
| Default value: [0] No operation | Parameter type: Option | Setup: All setups             |
| Conversion index: -             | Data type: Uint8       | Change during operation: True |

Select the function of terminal X45/3 as an analog current output.

| Option | Name                   | Description   |
|--------|------------------------|---|
| [0]*   | No operation           | Indicates no signal on the analog output.   |
| [52]   | MCO                    |   |
| [100]  | Output frequency       | 0 Hz = 0 mA; 100 Hz = 20 mA.  |
| [101]  | Reference              | <i>Parameter 3-00 Reference Range [Min - Max]</i> 0% = 0 mA; 100% = 20 mA<br><i>Parameter 3-00 Reference Range [-Max - Max]</i> -100% = 0 mA; 0% = 10 mA; +100% = 20 mA.  |
| [102]  | Feedback               |   |
| [103]  | Motor current          | The value is taken from <i>parameter 16-37 Inv. Max. Current</i> . The inverter maximum current (160% current) is equal to 20 mA.<br><b>Example:</b> Inverter normal current (11 kW) is 24 A. 160 %=38.4 A. Motor normal current is 22 A, the readout is 11.46 mA.<br>$\frac{20 \text{ mA} \times 22 \text{ A}}{38.4 \text{ A}} = 11.46 \text{ mA}$ When the normal motor current is equal to 20 mA, the output setting of <i>parameter 6-52 Terminal 42 Output Max Scale</i> is:<br>$\frac{I_{\text{VLT,MAX}} \times 100}{I_{\text{Motor,Nom}}} = \frac{38.4 \times 100}{22} = 175 \%$ |
| [104]  | Torque rel to limit    | The torque setting is related to the setting in <i>parameter 4-16 Torque Limit Motor Mode</i> .   |
| [105]  | Torque relate to rated | The torque is related to the motor torque setting.  |
| [106]  | Power                  | Taken from <i>parameter 1-20 Motor Power [kW]</i> .   |
| [107]  | Speed                  | Taken from <i>parameter 3-03 Maximum Reference</i> . 20 mA equals the value in <i>parameter 3-03 Maximum Reference</i> .  |
| [108]  | Torque                 | Torque reference related to 160% torque.  |
| [109]  | Max out freq           | 0 Hz = 0 mA, <i>parameter 4-19 Max Output Frequency</i> = 20 mA.  |
| [113]  | PID clamped output     |   |
| [117]  | Shaft power            |   |
| [118]  | Shaft power 4–20mA     |   |
| [119]  | Torque % lim           |   |
| [123]  | Speed both dir         |   |
| [124]  | Speed both dir 4–20mA  |   |
| [130]  | Output freq. 4–20mA    | 0 Hz = 4 mA, 100 Hz = 20 mA.  |
| [131]  | Reference 4–20mA       | <i>Parameter 3-00 Reference Range [Min-Max]</i> 0% = 4 mA; 100% = 20 mA<br><i>Parameter 3-00 Reference Range [-Max-Max]</i> -100% = 4 mA; 0% = 12 mA; +100% = 20 mA.  |

| Option | Name                 | Description  |
|--------|----------------------|--|
| [132]  | Feedback 4–20mA      |  |
| [133]  | Motor cur. 4–20mA    | <p>The value is taken from <i>parameter 16-37 Inv. Max. Current</i>. The inverter maximum current (160% current) is equal to 20 mA. Example: Inverter normal current (11 kW) is 24 A. 160% = 38.4 A. Motor normal current is 22 A, the readout is 11.46 mA.</p> $\frac{16 \text{ mA} \times 22 \text{ A}}{38.4 \text{ A}} = 13.17 \text{ mA}$ <p>If the normal motor current is equal to 20 mA, the output setting of <i>parameter 6-52 Terminal 42 Output Max Scale</i> is:</p> $\frac{I_{\text{VLT,MAX}} \times 100}{I_{\text{Motor, Nom}}} = \frac{38.4 \times 100}{22} = 175 \%$ |
| [134]  | Torq.% lim 4–20mA    | The torque setting is related to the setting in <i>parameter 4-16 Torque Limit Motor Mode</i> .  |
| [135]  | Torq.% nom 4–20mA    | The torque setting is related to the motor torque setting.   |
| [136]  | Power 4–20mA         | Taken from <i>parameter 1-20 Motor Power [kW]</i> .  |
| [137]  | Speed 4–20mA         | Taken from <i>parameter 3-03 Maximum Reference</i> . 20 mA = value in <i>parameter 3-03 Maximum Reference</i> .  |
| [138]  | Torque 4–20mA        | Torque reference related to 160% torque.   |
| [139]  | Bus ctrl.            | An output value set from fieldbus process data. The output works independently of internal functions in the drive.   |
| [140]  | Bus ctrl. 4–20mA     | An output value set from fieldbus process data. The output works independently of internal functions in the drive.   |
| [141]  | Bus ctrl t.o.        | <i>Parameter 4-54 Warning Reference Low</i> defines the behavior of the analog output in case of fieldbus timeout.   |
| [142]  | Bus ctrl 4-20mA t.o. | <i>Parameter 4-54 Warning Reference Low</i> defines the behavior of the analog output in case of fieldbus timeout.   |
| [147]  | Main act val         |  |
| [148]  | Main act val 4-20mA  |  |
| [149]  | Torque % lim 4-20mA  | Analog output at 0 torque is 12 mA. Motoring torque increases the output current to maximum torque limit 20 mA (set in <i>parameter 4-16 Torque Limit Motor Mode</i> ). Generating torque decreases the output to torque limit in generator mode (set in <i>parameter 4-17 Torque Limit Generator Mode</i> ) Example: <i>Parameter 4-16 Torque Limit Motor Mode</i> = 200% and <i>parameter 4-17 Torque Limit Generator Mode</i> = 200%. 20 mA = 200% motoring and 4 mA = 200% generating.   |
| [150]  | Max Out Fr 4-20mA    | 0 Hz = 0 mA, <i>parameter 4-19 Max Output Frequency</i> = 20 mA.   |
| [158]  | Motor Volt.          |  |
| [159]  | Motor Volt. 4-20mA   |  |

## Parameter 6-81 Terminal X45/3 Min. Scale

Table 442: Parameter 6-81 Terminal X45/3 Min. Scale

| 6-81 Terminal X45/3 Min. Scale |                                 |                               |
|--------------------------------|---------------------------------|-------------------------------|
| Default value: 0%              | Parameter type: Range, 0 - 200% | Setup: All setups             |
| Conversion index: -2           | Data type: Int16                | Change during operation: True |

Scales the minimum output of the selected analog signal on terminal X45/3. Scale the minimum value as a percentage of the maximum signal value, for example, 0 mA (or 0 Hz) is required at 25% of the maximum output value and 25% is programmed. The value can never exceed the corresponding setting in *parameter 6-82 Terminal X45/3 Max. Scale* if the value is below 100%. This parameter is active when VLT® Extended Relay Card MCB 113 is mounted in the drive.

## Parameter 6-82 Terminal X45/3 Max. Scale

Table 443: Parameter 6-82 Terminal X45/3 Max. Scale

| 6-82 Terminal X45/3 Max. Scale |                                 |                               |
|--------------------------------|---------------------------------|-------------------------------|
| Default value: 100%            | Parameter type: Range, 0 - 200% | Setup: All setups             |
| Conversion index: -2           | Data type: Int16                | Change during operation: True |

Scale the maximum output of the selected analog signal at terminal X45/3. Set the value to the maximum value of the current signal output. Scale the output to give a current lower than 20 mA at full scale, or 20 mA at an output below 100% of the maximum signal value. If 20 mA is the required output current at a value between 0–100% of the full-scale output, program the percentage value in the parameter, for example 50% = 20 mA. If a current 4–20 mA is required at maximum output (100%), calculate the percentage value as follows (example where required maximum output is 10 mA):

$$\frac{I_{\text{RANGE}} [\text{mA}]}{I_{\text{DESIRED MAX}} [\text{mA}]} \times 100\%$$

=

$$\frac{20 - 4 \text{ mA}}{10 \text{ mA}} \times 100\% = 160\%$$

## Parameter 6-83 Terminal X45/3 Bus Control

Table 444: Parameter 6-83 Terminal X45/3 Bus Control

| 6-83 Terminal X45/3 Bus Control |                                 |                               |
|---------------------------------|---------------------------------|-------------------------------|
| Default value: 0%               | Parameter type: Range, 0 - 100% | Setup: All setups             |
| Conversion index: -2            | Data type: N2                   | Change during operation: True |

Holds the level of analog output 4 (terminal X45/3) if controlled by bus.

## Parameter 6-84 Terminal X45/3 Output Timeout Preset

Table 445: Parameter 6-84 Terminal X45/3 Output Timeout Preset

| 6-84 Terminal X45/3 Output Timeout Preset |                                 |                               |
|---|---------------------------------|-------------------------------|
| Default value: 0%                         | Parameter type: Range, 0 - 100% | Setup: 1 setup                |
| Conversion index: -2                      | Data type: Uint16               | Change during operation: True |

Holds the preset level of output 4 (X45/3). If there is a fieldbus timeout and a timeout function is selected in *parameter 6-80 Terminal X45/3 Output*, the output is preset to this level.

## 5.8 Parameter Group 7-\*\* Controllers

### 5.8.1 Speed PID Droop

This feature implements precise torque sharing between multiple motors on a common mechanical shaft. Speed PID droop is useful for marine and mining applications where redundancy and higher dynamics are required. Speed PID droop allows to reduce inertia by utilizing multiple small motors instead of 1 large motor.

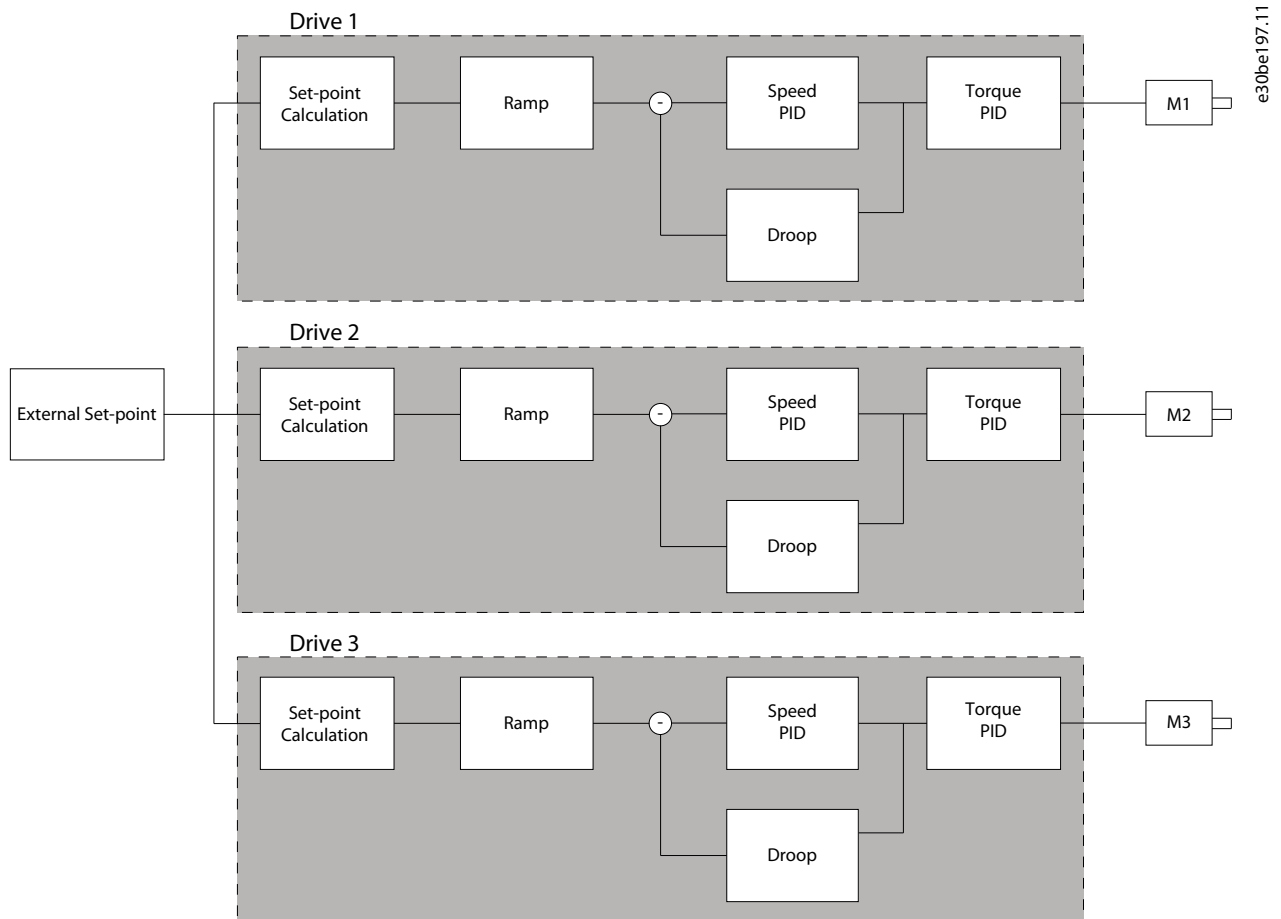

Illustration 72: Concept of Speed PID Droop

The value in *parameter 7-01 Speed PID Droop* ensures that the load is shared equally between the motors. If the torque on the motor is 100% of nominal motor torque, the drive reduces its output to this motor by 100% of the value in *parameter 7-01 Speed PID Droop*. If the torque is 50% of nominal motor torque, the drive reduces its output to this motor by 50% of the value in *parameter 7-01 Speed PID Droop*. This ensures that the motors share the load evenly. A side effect of using speed PID droop is that the actual shaft speed does not match the reference exactly. Speed PID droop is not efficient in low-speed applications because the adjustment range may be insufficient.

Use speed trim if the application requires the following features:

- Accurate speed (the actual shaft speed matches the reference speed).
- Precise speed adjustment down to 0 RPM.

#### Enabling PID droop

To enable speed PID droop:

- Run the drive in 1 of the following modes:
  - Flux closed loop (*parameter 1-01 Motor Control Principle, [3] Flux w/ motor feedb*).
  - Flux sensorless (*parameter 1-01 Motor Control Principle, [2] Flux sensorless*).
- Run the drive in speed mode (*parameter 1-00 Configuration Mode, option [0] Speed open loop or [1] Speed closed loop*).
- Ensure that *parameter 1-62 Slip Compensation* contains the default value (0%).
- Ensure that all drives in the torque sharing system use the same speed reference and start and stop signal.

- Ensure that all drives in the torque sharing system use the same parameter settings.
- Adjust the value in *parameter 7-01 Speed PID Droop*.

**NOTICE**

Do not use overvoltage control when using the PID droop function (select [0] Disabled in *parameter 2-17 Over-voltage Control*).

**NOTICE**

If the speed reference is lower than the value in *parameter 7-01 Speed PID Droop*, the drive makes the PID droop factor equal to the speed reference.

### 5.8.2 Speed Trim

The speed trim function is an add-on to the speed PID droop. The speed trim provides torque sharing with precise speed down to 0 RPM. The function requires wiring of analog signals.

In speed trim, the master drive runs normal speed PID without droop. The follower drives use the speed PID droop, but instead of reacting on their own load, they compare their own load to the load of other drives in the system. The follower drives then use that data as input for the speed PID droop. A setup with a single source, where the master drive sends information about torque to all followers, is limited by the number of available analog outputs on the master drive. It is possible to use a cascade principle which overcomes this limitation, but makes the control slower and less accurate. The master drive operates in speed mode. The follower drives operate in speed mode with the speed trim. The trim function uses torque data from all drives in the system.

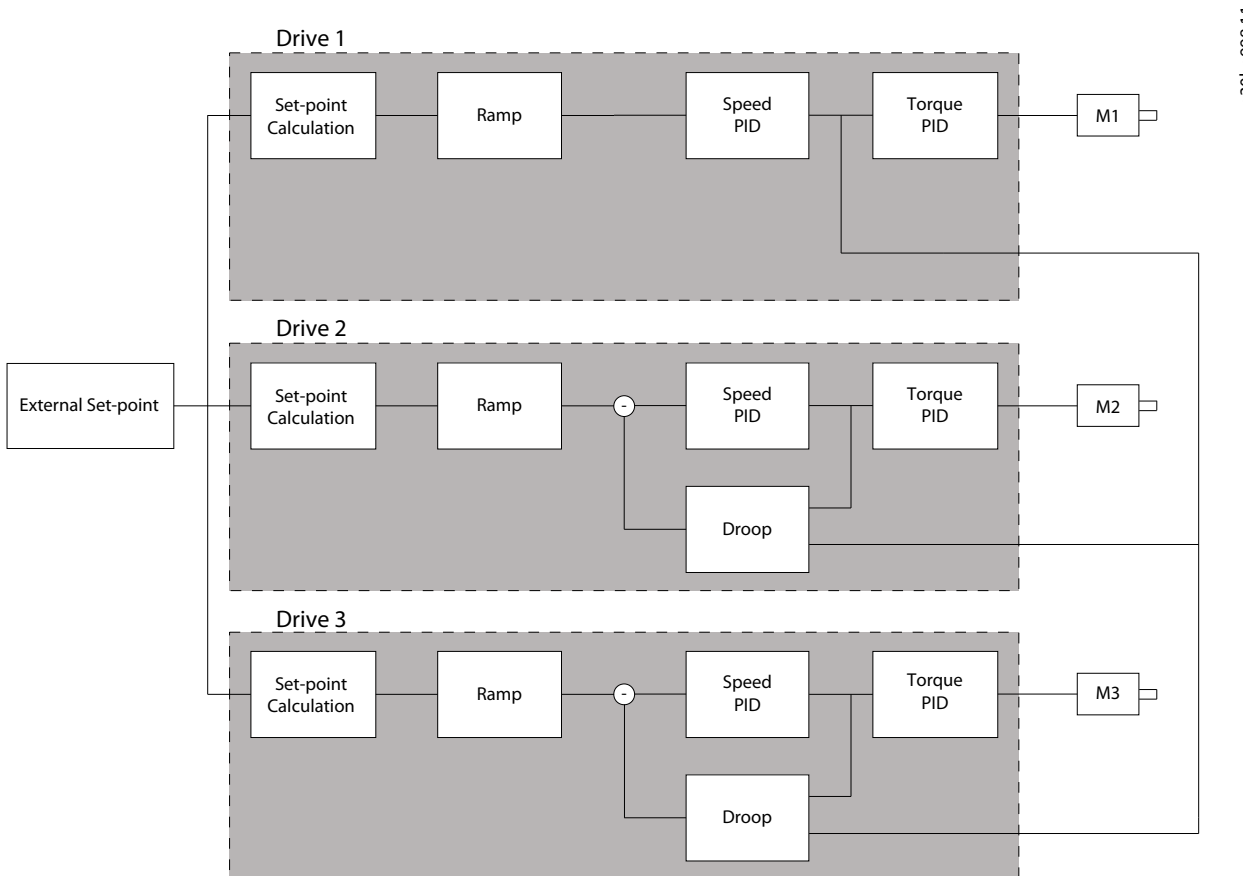

e30be998.11

**Illustration 73: Speed Trim**

The drawing shows a single-source setup where the master sends the torque signal to all followers. The number of available analog outputs on the master limits this setup. To overcome the limitation of the number of analog outputs, use a cascade principle. The cascade principle makes the control slower and less accurate compared with the setup using analog outputs.

## 5.8.3 7-0\* Speed PID Ctrl.

### N O T I C E

If separate encoders are used (FC 302 only), adjust the ramp-related parameters according to the gear ratio between the 2 encoders.

## Parameter 7-00 Speed PID Feedback Source

Table 446: Parameter 7-00 Speed PID Feedback Source

| 7-00 Speed PID Feedback Source |                        |                                |
|--------------------------------|------------------------|--------------------------------|
| Default value: Size related    | Parameter type: Option | Setup: All setups              |
| Conversion index: –            | Data type: Uint8       | Change during operation: False |

| Op-tion | Name               | Description   |
|---------|--------------------|---|
| [0]     | Motor feedb. P1-02 | <div style="text-align: center;"> <h3 style="margin: 0;">N O T I C E</h3> <p style="margin: 0;">This option is only available FC 302.</p> </div> <p>Use the feedback source selected as motor feedback in <i>parameter 1-02 Flux Motor Feedback Source</i>.</p> |
| [1]     | 24V encoder 32/33  | Single signal generated from 24 V High Threshold Logic (HTL) encoder connected to terminals 32 and 33. Configure the 24 V encoder interface in <i>parameter group 5-7* 24V Encoder Input</i> . Program terminals 32/33 to [0] No operation.                     |
| [2]     | MCB 102            | This is only available for VLT® Encoder Option MCB 102. Configure the encoder interface in <i>parameter groups 17-0*, 17-1*, and 17-2*</i> .  |
| [3]     | MCB 103            | This is only available for VLT® Resolver Option MCB 103. Configure the resolver interface in <i>parameter group 17-5* Resolver Interface</i> .  |
| [4]     | MCO Encoder 1 X56  | The MCO encoder 1 X56 is only available with motion control options MCO 305, MCO 350, and MCO 351. Configure the encoder interface in <i>parameter group 32-3* Encoder 1</i> .  |
| [5]     | MCO Encoder 2 X55  | The MCO encoder 1 X56 is only available with motion control options MCO 305, MCO 350, and MCO 351. Configure the encoder interface in <i>parameter group 32-0* Encoder 2</i> .  |
| [6]     | Analog input 53    |   |
| [7]     | Analog input 54    |   |
| [8]     | Frequency input 29 | <div style="text-align: center;"> <h3 style="margin: 0;">N O T I C E</h3> <p style="margin: 0;">This option is only available FC 302.</p> </div>  |
| [9]     | Frequency input 33 |   |

| Option | Name              | Description   |
|--------|-------------------|---|
| [11]   | MCB15X            |   |
| [12]   | MCB 102 Absolute  | The option is only available for VLT® Encoder Option MCB 102 module option with version 4.00 and newer and when <i>parameter 17-00 Encoders Connected</i> is set to [1] <i>Two Encoders</i> .   |
| [13]   | 24V encoder 27/29 | Single signal generated from 24 V High Threshold Logic (HTL) encoder connected to terminals 27 and 29. Configure the 24 V encoder interface in <i>parameter group 5-7* 24V Encoder Input</i> . Program terminals 27/29 to [0] <i>No operation</i> . |

### Parameter 7-01 Speed PID Droop

Table 447: Parameter 7-01 Speed PID Droop

| 7-01 Speed PID Droop |                                    |                               |
|----------------------|------------------------------------|-------------------------------|
| Default value: 0 RPM | Parameter type: Range, 0 - 200 RPM | Setup: All setups             |
| Conversion index: 67 | Data type: Uint16                  | Change during operation: True |

The droop function allows the drive to decrease the motor speed proportional to the load. The droop value is directly proportional to the load value. Use the droop function when several motors are mechanically connected and the load on motors can differ. Ensure that *parameter 1-62 Slip Compensation* has a default setting. Enter the droop value at 100% load.

### Parameter 7-02 Speed PID Proportional Gain

Table 448: Parameter 7-02 Speed PID Proportional Gain

| 7-02 Speed PID Proportional Gain |                              |                               |
|----------------------------------|------------------------------|-------------------------------|
| Default value: 0.015             | Parameter type: Range, 0 - 1 | Setup: All setups             |
| Conversion index: -3             | Data type: Uint16            | Change during operation: True |

Enter the speed controller proportional gain. The proportional gain amplifies the error (that is the deviation between the feedback signal and the setpoint). This parameter is used with *parameter 1-00 Configuration Mode* [0] *Speed open loop* and [1] *Speed closed loop control*. Quick control is obtained at high amplification. Increasing amplification makes the process less stable. For values with 4 decimals, use *parameter 30-83 Speed PID Proportional Gain*.

### Parameter 7-03 Speed PID Integral Time

Table 449: Parameter 7-03 Speed PID Integral Time

| 7-03 Speed PID Integral Time |                                       |                               |
|------------------------------|---------------------------------------|-------------------------------|
| Default value: Size related  | Parameter type: Range, 1.0 - 20000 ms | Setup: All setups             |
| Conversion index: -4         | Data type: Uint32                     | Change during operation: True |

Enter the speed controller integral time, which determines the time the internal PID control takes to correct errors. The greater the error, the more quickly the gain increases. The integral time causes a delay of the signal and therefore a dampening effect and can be used to eliminate steady-state speed error. Obtain quick control through a short integral time, though if the integral time is too short, the process becomes unstable. An excessively long integral time disables the integral action, leading to major deviations from the required reference, since the process regulator takes too long to regulate errors. This parameter is used with [0] *Speed open loop* and [1] *Speed closed loop control*, set in *parameter 1-00 Configuration Mode*.

### Parameter 7-04 Speed PID Differentiation Time

Table 450: Parameter 7-04 Speed PID Differentiation Time

| 7-04 Speed PID Differentiation Time |                                   |                               |
|-------------------------------------|-----------------------------------|-------------------------------|
| Default value: Size related         | Parameter type: Range, 0 - 200 ms | Setup: All setups             |
| Conversion index: -4                | Data type: Uint16                 | Change during operation: True |



Enter the speed controller differentiation time. The differentiator does not react to constant error. It provides gain proportional to the rate of change of the speed feedback. The quicker the error changes, the stronger the gain from the differentiator. The gain is proportional with the speed at which errors change. Setting this parameter to 0 disables the differentiator. This parameter is used with *parameter 1-00 Configuration Mode, [1] Speed closed loop control*.

Parameter 7-05 Speed PID Diff. Gain Limit

Table 451: Parameter 7-05 Speed PID Diff. Gain Limit

| 7-05 Speed PID Diff. Gain Limit |                               |                               |
|---------------------------------|-------------------------------|-------------------------------|
| Default value: 5                | Parameter type: Range, 1 - 20 | Setup: All setups             |
| Conversion index: -1            | Data type: Uint16             | Change during operation: True |

Set a limit for the gain provided by the differentiator. Consider limiting the gain at higher frequencies. For example, set up a pure D-link at low frequencies and a constant D-link at higher frequencies. This parameter is used with *parameter 1-00 Configuration Mode, [1] Speed closed loop control*.

Parameter 7-06 Speed PID Lowpass Filter Time

Table 452: Parameter 7-06 Speed PID Lowpass Filter Time

| 7-06 Speed PID Lowpass Filter Time |                                     |                               |
|------------------------------------|-------------------------------------|-------------------------------|
| Default value: Size related        | Parameter type: Range, 0.1 - 100 ms | Setup: All setups             |
| Conversion index: -4               | Data type: Uint16                   | Change during operation: True |

## NOTICE

Severe filtering can be detrimental to dynamic performance. This parameter is used with *parameter 1-00 Configuration Mode, [1] Speed closed loop and [2] Torque control*. Adjust the filter time in flux sensorless to 3–5 ms.

Set a time constant for the speed control low-pass filter. The low-pass filter improves steady-state performance and dampens oscillations on the feedback signal. This is an advantage if there is a great amount of noise in the system. For example, if a time constant ( $\tau$ ) of 100 ms is programmed, the cut-off frequency for the low-pass filter is  $1/0.1 = 10 \text{ RAD/s}$ , corresponding to  $(10/2 \times \pi) = 1.6 \text{ Hz}$ . The PID regulator only regulates a feedback signal that varies by a frequency of less than 1.6 Hz. If the feedback signal varies by a higher frequency than 1.6 Hz, the PID regulator does not react. Practical settings of *parameter 7-06 Speed PID Lowpass Filter Time* taken from the number of pulses per revolutions from encoder:

Table 453: Speed PID Low-pass Filter Time

| Encoder PPR | Parameter 7-06 Speed PID Lowpass Filter Time [ms] |
|-------------|---|
| 512         | 10  |
| 1024        | 5   |
| 2048        | 2   |
| 4096        | 1   |

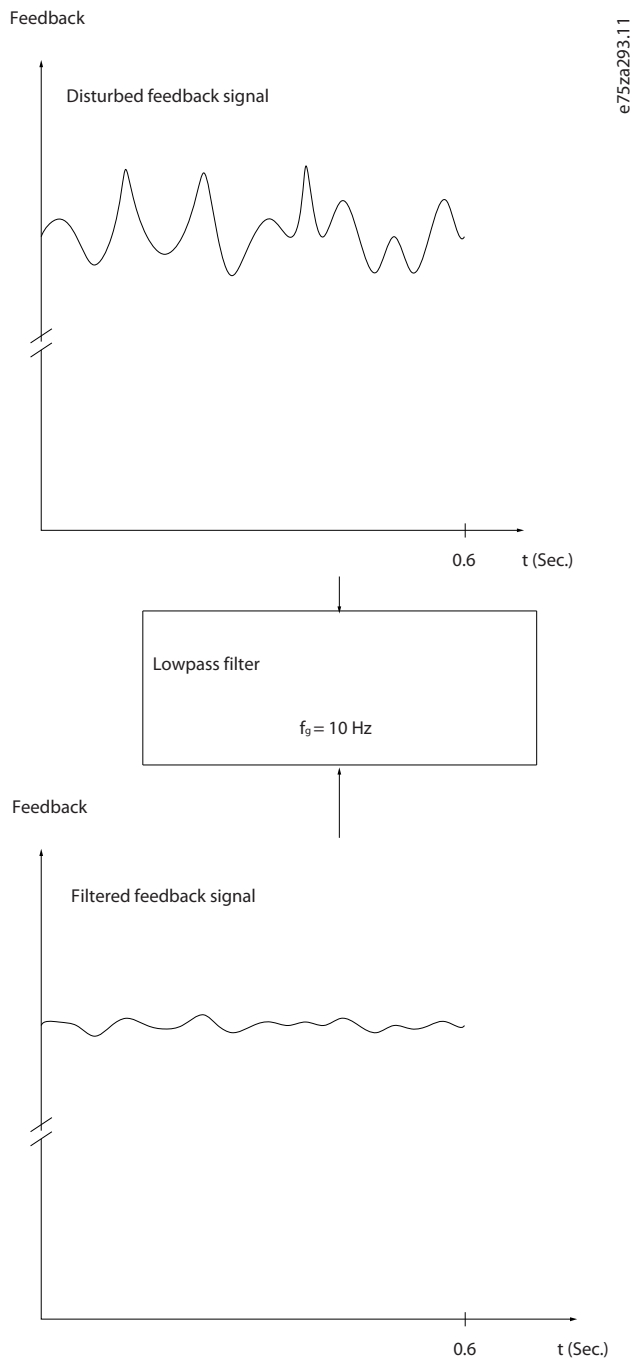

Illustration 74: Feedback Signal

Parameter 7-07 Speed PID Feedback Gear Ratio

Table 454: Parameter 7-07 Speed PID Feedback Gear Ratio

| 7-07 Speed PID Feedback Gear Ratio |   |                                |
|------------------------------------|---|--------------------------------|
| Default value: 1                   | Parameter type: Range, 0.0001 - 32.0000 | Setup: All setups              |
| Conversion index: -4               | Data type: Uint32                       | Change during operation: False |

The drive multiplies the speed feedback by this ratio.

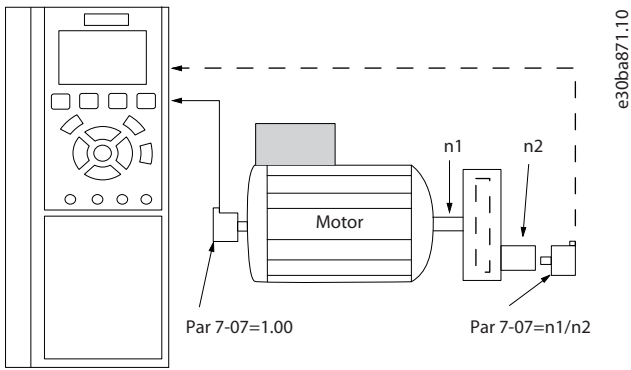

Illustration 75: Speed PID Feedback Gear Ratio

Parameter 7-08 Speed PID Feed Forward Factor

Table 455: Parameter 7-08 Speed PID Feed Forward Factor

| 7-08 Speed PID Feed Forward Factor |                                 |                                |
|------------------------------------|---------------------------------|--------------------------------|
| Default value: 0%                  | Parameter type: Range, 0 - 500% | Setup: All setups              |
| Conversion index: 0                | Data type: Uint16               | Change during operation: False |

The reference signal bypasses the speed controller by the amount specified. This feature increases the dynamic performance of the speed control loop.

Parameter 7-09 Speed PID Error Correction w/Ramp

Table 456: Parameter 7-09 Speed PID Error Correction w/Ramp

| 7-09 Speed PID Error Correction w/Ramp |  |                               |
|--|--|-------------------------------|
| Default value: Size related            | Parameter type: Range, 10 - 100000 RPM | Setup: All setups             |
| Conversion index: 67                   | Data type: Uint32                      | Change during operation: True |

The speed error between ramp and actual speed is held up against the setting in this parameter. If the speed error exceeds this parameter entry, the speed error is corrected via ramping in a controlled way.

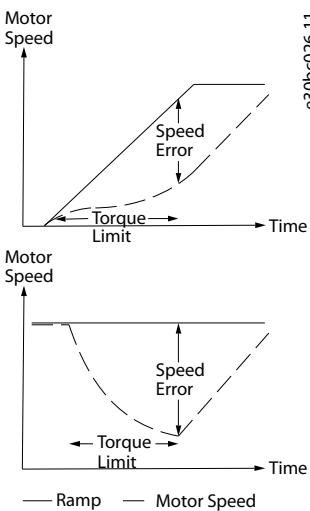

Illustration 76: Speed Error Between Ramp and Actual Speed

5.8.4 7-1\* Torque PI Control

Parameters for configuring the torque PI control.

Parameter 7-10 Torque PI Feedback Source  
 Parameter 7-12 Torque PI Proportional Gain  
 Parameter 7-13 Torque PI Integration Time  
 Parameter 7-16 Torque PI Lowpass Filter Time

Table 457: Parameter 7-16 Torque PI Lowpass Filter Time

| 7-16 Torque PI Lowpass Filter Time |                                     |                               |
|------------------------------------|-------------------------------------|-------------------------------|
| Default value: 5 ms                | Parameter type: Range, 0.1 - 100 ms | Setup: All setups             |
| Conversion index: -4               | Data type: Uint16                   | Change during operation: True |

Enter the time constant for the torque control low-pass filter.  
 Parameter 7-18 Torque PI Feed Forward Factor

Table 458: Parameter 7-18 Torque PI Feed Forward Factor

| 7-18 Torque PI Feed Forward Factor |                                 |                               |
|------------------------------------|---------------------------------|-------------------------------|
| Default value: 0%                  | Parameter type: Range, 0 - 100% | Setup: All setups             |
| Conversion index: 0                | Data type: Uint16               | Change during operation: True |

Enter the torque feed-forward factor value. The reference signal bypasses the torque controller by this value.  
 Parameter 7-19 Current Controller Rise Time

Table 459: Parameter 7-19 Current Controller Rise Time

| 7-19 Current Controller Rise Time |                                  |                               |
|-----------------------------------|----------------------------------|-------------------------------|
| Default value: Size related       | Parameter type: Range, 15 - 100% | Setup: All setups             |
| Conversion index: 0               | Data type: Uint16                | Change during operation: True |

Enter the value for the rise time of the current controller as a percentage of the control period.

### 5.8.5 7-2\* Process Ctrl. Feedb.

Select the feedback sources for the process PID control, and how this feedback should be handled.

Parameter 7-20 Process CL Feedback 1 Resource

Table 460: Parameter 7-20 Process CL Feedback 1 Resource

| 7-20 Process CL Feedback 1 Resource |                        |                               |
|-------------------------------------|------------------------|-------------------------------|
| Default value: [0] No function      | Parameter type: Option | Setup: All setups             |
| Conversion index: -                 | Data type: Uint8       | Change during operation: True |

The effective feedback signal is made up of the sum of up to 2 different input signals. Select which drive input should be treated as the source of the 1<sup>st</sup> of these signals. The 2<sup>nd</sup> input signal is defined in *parameter 7-22 Process CL Feedback 2 Resource*.

| Option | Name               | Description  |
|--------|--------------------|--|
| [0]*   | No function        |  |
| [1]    | Analog input 53    |  |
| [2]    | Analog input 54    |  |
| [3]    | Frequency input 29 | <div style="text-align: center; background-color: #cccccc; padding: 5px;"><b>NOTICE</b></div> This option is only available in FC 302. |

| Option | Name                | Description |
|--------|---------------------|-------------|
| [4]    | Frequency input 33  |             |
| [7]    | Analog input X30/11 |             |
| [8]    | Analog input X30/12 |             |
| [15]   | Analog input X48/2  |             |
| [16]   | Analog input X49/1  |             |
| [17]   | Analog input X49/3  |             |
| [18]   | Analog input X49/5  |             |

## Parameter 7-22 Process CL Feedback 2 Resource

Table 461: Parameter 7-22 Process CL Feedback 2 Resource

| 7-22 Process CL Feedback 2 Resource |                        |                               |
|-------------------------------------|------------------------|-------------------------------|
| Default value: [0] No function      | Parameter type: Option | Setup: All setups             |
| Conversion index: –                 | Data type: Uint8       | Change during operation: True |

The effective feedback signal is made up of the sum of up to 2 different input signals. Select which drive input should be treated as the source of the 2<sup>nd</sup> of these signals. The 1<sup>st</sup> input signal is defined in *parameter 7-20 Process CL Feedback 1 Resource*.

| Option | Name                | Description   |
|--------|---------------------|---|
| [0]*   | No function         |   |
| [1]    | Analog input 53     |   |
| [2]    | Analog input 54     |   |
| [3]    | Frequency input 29  | <div style="text-align: center; background-color: #cccccc; padding: 5px;"><b>NOTICE</b></div> <div style="border: 1px solid black; padding: 5px; margin-top: 5px;">This option is only available in FC 302.</div> |
| [4]    | Frequency input 33  |   |
| [7]    | Analog input X30/11 |   |
| [8]    | Analog input X30/12 |   |
| [15]   | Analog input X48/2  |   |
| [16]   | Analog input X49/1  |   |
| [17]   | Analog input X49/3  |   |
| [18]   | Analog input X49/5  |   |

### 5.8.6 7-3\* Process PID Ctrl.

#### Parameter 7-30 Process PID Normal/ Inverse Control

Table 462: Parameter 7-30 Process PID Normal/ Inverse Control

| 7-30 Process PID Normal/ Inverse Control |                        |                               |
|--|------------------------|-------------------------------|
| Default value: [0] Normal                | Parameter type: Option | Setup: All setups             |
| Conversion index: –                      | Data type: Uint8       | Change during operation: True |

Normal and inverse controls are implemented by introducing a difference between the reference signal and the feedback signal.

| Option | Name    | Description                                       |
|--------|---------|---|
| [0]*   | Normal  | Set the process to increase the output frequency. |
| [1]    | Inverse | Set the process to decrease the output frequency. |

#### Parameter 7-31 Process PID Anti Windup

Table 463: Parameter 7-31 Process PID Anti Windup

| 7-31 Process PID Anti Windup |                        |                               |
|------------------------------|------------------------|-------------------------------|
| Default value: [1] On        | Parameter type: Option | Setup: All setups             |
| Conversion index: –          | Data type: Uint8       | Change during operation: True |

Normal and inverse controls are implemented by introducing a difference between the reference signal and the feedback signal.

| Option | Name | Description  |
|--------|------|--|
| [0]    | Off  | Continue regulation of an error even when the output frequency cannot be increased or decreased. |
| [1]*   | On   | Cease regulation of an error when the output frequency can no longer be adjusted.                |

#### Parameter 7-32 Process PID Start Speed

Table 464: Parameter 7-32 Process PID Start Speed

| 7-32 Process PID Start Speed |                                     |                               |
|------------------------------|-------------------------------------|-------------------------------|
| Default value: 0 RPM         | Parameter type: Range, 0 - 6000 RPM | Setup: All setups             |
| Conversion index: 67         | Data type: Uint16                   | Change during operation: True |

Enter the motor speed to be attained as a start signal for commencement of PID control. When the power is switched on, the drive starts to ramp and then operates under speed open-loop control. When the process PID start speed is reached, the drive changes to process PID control.

#### Parameter 7-33 Process PID Proportional Gain

Table 465: Parameter 7-33 Process PID Proportional Gain

| 7-33 Process PID Proportional Gain |                               |                               |
|------------------------------------|-------------------------------|-------------------------------|
| Default value: 0.10                | Parameter type: Range, 0 - 10 | Setup: All setups             |
| Conversion index: -2               | Data type: Uint16             | Change during operation: True |

Enter the PID proportional gain. The proportional gain multiplies the error between the setpoint and the feedback signal.

## Parameter 7-34 Process PID Integral Time

Table 466: Parameter 7-34 Process PID Integral Time

| 7-34 Process PID Integral Time |                                       |                               |
|--------------------------------|---------------------------------------|-------------------------------|
| Default value: 10000 s         | Parameter type: Range, 0.01 - 10000 s | Setup: All setups             |
| Conversion index: -2           | Data type: Uint32                     | Change during operation: True |

Enter the PID integral time. The integrator provides an increasing gain at a constant error between the setpoint and the feedback signal. The integral time is the time needed by the integrator to reach the same gain as the proportional gain.

## Parameter 7-35 Process PID Differentiation Time

Table 467: Parameter 7-35 Process PID Differentiation Time

| 7-35 Process PID Differentiation Time |                                 |                               |
|---------------------------------------|---------------------------------|-------------------------------|
| Default value: 0 s                    | Parameter type: Range, 0 - 10 s | Setup: All setups             |
| Conversion index: -2                  | Data type: Uint16               | Change during operation: True |

Enter the PID differentiation time. The differentiator does not react to a constant error, but provides a gain only when the error changes. The shorter the PID differentiation time, the stronger the gain from the differentiator.

## Parameter 7-36 Process PID Diff. Gain Limit

Table 468: Parameter 7-36 Process PID Diff. Gain Limit

| 7-36 Process PID Diff. Gain Limit |                               |                               |
|-----------------------------------|-------------------------------|-------------------------------|
| Default value: 5                  | Parameter type: Range, 1 - 50 | Setup: All setups             |
| Conversion index: -1              | Data type: Uint16             | Change during operation: True |

Enter a limit for the differentiator gain. If there is no limit, the differentiator gain increases when there are fast changes. To obtain a pure differentiator gain at slow changes and a constant differentiator gain where fast changes occur, limit the differentiator gain.

## Parameter 7-38 Process PID Feed Forward Factor

Table 469: Parameter 7-38 Process PID Feed Forward Factor

| 7-38 Process PID Feed Forward Factor |                                 |                               |
|--------------------------------------|---------------------------------|-------------------------------|
| Default value: 0%                    | Parameter type: Range, 0 - 200% | Setup: All setups             |
| Conversion index: 0                  | Data type: Uint16               | Change during operation: True |

Enter the PID feed-forward factor. The factor sends a constant fraction of the reference signal to bypass the PID control, so the PID control only affects the remaining fraction of the control signal. Any change to this parameter affects the motor speed. When the feed-forward factor is activated, it provides less overshoot and high dynamics when changing the setpoint. *Parameter 7-38 Process PID Feed Forward Factor* is active when *parameter 1-00 Configuration Mode* is set to [3] Process.

## Parameter 7-39 On Reference Bandwidth

Table 470: Parameter 7-39 On Reference Bandwidth

| 7-39 On Reference Bandwidth |                                 |                               |
|-----------------------------|---------------------------------|-------------------------------|
| Default value: 5%           | Parameter type: Range, 0 - 200% | Setup: All setups             |
| Conversion index: 0         | Data type: Uint8                | Change during operation: True |

Enter the on-reference bandwidth. When the PID control error (the difference between the reference and the feedback) is less than the value of this parameter, the on-reference status bit is 1.

### 5.8.7 7-4\* Advanced Process PID Ctrl.

#### NOTICE

The following parameter is only available in FC 302:

- Parameter 7-48 PCD Feed Forward

This parameter group is only used if *parameter 1-00 Configuration Mode* is set to [7] *Extended PID speed CL* or [8] *Extended PID Speed OL*.

#### Parameter 7-40 Process PID I-part Reset

**Table 471: Parameter 7-40 Process PID I-part Reset**

| 7-40 Process PID I-part Reset |                        |                               |
|-------------------------------|------------------------|-------------------------------|
| Default value: [0] No         | Parameter type: Option | Setup: All setups             |
| Conversion index: -           | Data type: Uint8       | Change during operation: True |

Select the feedback source for the torque controller.

| Option | Name | Description   |
|--------|------|---|
| [0]*   | No   |   |
| [1]    | Yes  | Select [1] Yes to reset the I-part of the process PID controller. The selection automatically returns to [0] No. Re-setting the I-part makes it possible to start from a well-defined point after changing something in the process, for example changing a textile roll. |

#### Parameter 7-41 Process PID Output Neg. Clamp

**Table 472: Parameter 7-41 Process PID Output Neg. Clamp**

| 7-41 Process PID Output Neg. Clamp |   |                               |
|------------------------------------|---|-------------------------------|
| Default value: -100%               | Parameter type: Range, -100 - par. 7-42 % | Setup: All setups             |
| Conversion index: 0                | Data type: Int16                          | Change during operation: True |

Enter a negative limit for the process PID controller output.

#### Parameter 7-42 Process PID Output Pos. Clamp

**Table 473: Parameter 7-42 Process PID Output Pos. Clamp**

| 7-42 Process PID Output Pos. Clamp |   |                               |
|------------------------------------|---|-------------------------------|
| Default value: 100%                | Parameter type: Range, par. 7-41 % - 100% | Setup: All setups             |
| Conversion index: 0                | Data type: Int16                          | Change during operation: True |

Enter a positive limit for the process PID controller output.

#### Parameter 7-43 Process PID Gain Scale at Min. Ref.

**Table 474: Parameter 7-43 Process PID Gain Scale at Min. Ref.**

| 7-43 Process PID Gain Scale at Min. Ref. |                                 |                               |
|--|---------------------------------|-------------------------------|
| Default value: -100%                     | Parameter type: Range, 0 - 100% | Setup: All setups             |
| Conversion index: 0                      | Data type: Int16                | Change during operation: True |

Enter a scaling percentage to apply to the process PID output when operating at the minimum reference. The scaling percentage is adjusted linearly between the scale at minimum reference (*parameter 7-43 Process PID Gain Scale at Min. Ref.*) and the scale at maximum reference (*parameter 7-44 Process PID Gain Scale at Max. Ref.*).



Parameter 7-44 Process PID Gain Scale at Max. Ref.

Table 475: Parameter 7-44 Process PID Gain Scale at Max. Ref.

| 7-44 Process PID Gain Scale at Max. Ref. |                                 |                               |
|--|---------------------------------|-------------------------------|
| Default value: -100%                     | Parameter type: Range, 0 - 100% | Setup: All setups             |
| Conversion index: 0                      | Data type: Int16                | Change during operation: True |

Enter a scaling percentage to apply to the process PID output when operating at the maximum reference. The scaling percentage is adjusted linearly between the scale at minimum reference (*parameter 7-43 Process PID Gain Scale at Min. Ref.*) and the scale at maximum reference (*parameter 7-44 Process PID Gain Scale at Max. Ref.*).

Parameter 7-45 Process PID Feed Fwd Resource

Table 476: Parameter 7-45 Process PID Feed Fwd Resource

| 7-45 Process PID Feed Fwd Resource |                        |                               |
|------------------------------------|------------------------|-------------------------------|
| Default value: [0] No function     | Parameter type: Option | Setup: All setups             |
| Conversion index: -                | Data type: Uint8       | Change during operation: True |

| Option | Name                | Description   |
|--------|---------------------|---|
| [0]*   | No function         | Select which drive input should be used as the feed-forward factor. The factor is added to the output of the PID controller. This increases dynamic performance.  |
| [1]    | Analog input 53     |   |
| [2]    | Analog input 54     |   |
| [7]    | Frequency input 29  | <div style="text-align: center; background-color: #cccccc; padding: 5px;"><b>NOTICE</b></div> <p>This option is only available in FC 302.</p>   |
| [8]    | Frequency input 33  |   |
| [11]   | Local bus reference |   |
| [20]   | Digital pot.meter   |   |
| [21]   | Analog input X30/11 |   |
| [22]   | Analog input X30/12 |   |
| [29]   | Analog input X48/2  |   |
| [32]   | Bus PCD             | <div style="text-align: center; background-color: #cccccc; padding: 5px;"><b>NOTICE</b></div> <p>This option is only available in FC 302.</p> <p>Selects a fieldbus reference configured by <i>parameter 8-02 Control Word Source</i>. Change <i>parameter 8-42 PCD Write Configuration</i> for the bus used to make the feed forward available in <i>parameter 7-48 PCD Feed Forward</i>. Use index 1 for feed forward [748] (and index 2 for reference [1682]).</p> |

Parameter 7-46 Process PID Feed Fwd Normal/Inv. Ctrl.

Table 477: Parameter 7-46 Process PID Feed Fwd Normal/Inv. Ctrl.

| 7-46 Process PID Feed Fwd Normal/Inv. Ctrl. |                        |                               |
|---|------------------------|-------------------------------|
| Default value: [0] Normal                   | Parameter type: Option | Setup: All setups             |
| Conversion index: –                         | Data type: Uint8       | Change during operation: True |

| Option | Name    | Description   |
|--------|---------|---|
| [0]*   | Normal  | Select [0] <i>Normal</i> to set the feed-forward factor to treat the FF resource as a positive value. |
| [1]    | Inverse | Select [1] <i>Inverse</i> to treat the feed-forward resource as a negative value.                     |

Parameter 7-48 PCD Feed Forward

Table 478: Parameter 7-48 PCD Feed Forward

| 7-48 PCD Feed Forward |                                  |                               |
|-----------------------|----------------------------------|-------------------------------|
| Default value: 0      | Parameter type: Range, 0 - 65535 | Setup: All setups             |
| Conversion index: 0   | Data type: Uint16                | Change during operation: True |

This parameter contains the value of *parameter 7-45 Process PID Feed Fwd Resource*, [32] *Bus PCD*.

Parameter 7-49 Process PID Output Normal/Inv. Ctrl.

Table 479: Parameter 7-49 Process PID Output Normal/Inv. Ctrl.

| 7-49 Process PID Output Normal/Inv. Ctrl. |                        |                               |
|---|------------------------|-------------------------------|
| Default value: [0] Normal                 | Parameter type: Option | Setup: All setups             |
| Conversion index: –                       | Data type: Uint8       | Change during operation: True |

| Option | Name    | Description   |
|--------|---------|---|
| [0]*   | Normal  | Select [0] <i>Normal</i> to use the resulting output from the process PID controller as is.   |
| [1]    | Inverse | Select [1] <i>Inverse</i> to invert the resulting output from the process PID controller. This operation is performed after the feed-forward factor is applied. |

### 5.8.8 7-5\* Ext. Process PID Ctrl.

This parameter group is only used if *parameter 1-00 Configuration Mode* is set to [7] *Extended PID speed CL* or [8] *Extended PID Speed OL*.

Parameter 7-50 Process PID Extended PID

Table 480: Parameter 7-50 Process PID Extended PID

| 7-50 Process PID Extended PID |                        |                               |
|-------------------------------|------------------------|-------------------------------|
| Default value: [1] Enabled    | Parameter type: Option | Setup: All setups             |
| Conversion index: –           | Data type: Uint8       | Change during operation: True |

| Option | Name     | Description   |
|--------|----------|---|
| [0]    | Disabled | Disable the extended parts of the process PID controller. |
| [1]*   | Enabled  | Enable the extended parts of the PID controller.          |

## Parameter 7-51 Process PID Feed Fwd Gain

Table 481: Parameter 7-51 Process PID Feed Fwd Gain

| 7-51 Process PID Feed Fwd Gain |                                |                               |
|--------------------------------|--------------------------------|-------------------------------|
| Default value: 1               | Parameter type: Range, 0 - 100 | Setup: All setups             |
| Conversion index: -2           | Data type: Uint16              | Change during operation: True |

The feed forward is used to obtain the required level based on a well-known signal available. The PID controller then only takes care of the smaller part of the control, necessary because of unknown characters. The standard feed-forward factor in *parameter 7-38 Process PID Feed Forward Factor* is always related to the reference, whereas *parameter 7-51 Process PID Feed Fwd Gain* has more options. In winder applications, the feed-forward factor is typically the line speed of the system.

## Parameter 7-52 Process PID Feed Fwd Ramp Up

Table 482: Parameter 7-52 Process PID Feed Fwd Ramp Up

| 7-52 Process PID Feed Fwd Ramp Up |                                    |                               |
|-----------------------------------|------------------------------------|-------------------------------|
| Default value: 0.01 s             | Parameter type: Range, 0.01 - 10 s | Setup: All setups             |
| Conversion index: -2              | Data type: Uint32                  | Change during operation: True |

Controls the dynamics of the feed-forward signal when ramping up.

## Parameter 7-53 Process PID Feed Fwd Ramp Down

Table 483: Parameter 7-53 Process PID Feed Fwd Ramp Down

| 7-53 Process PID Feed Fwd Ramp Down |                                    |                               |
|-------------------------------------|------------------------------------|-------------------------------|
| Default value: 0.01 s               | Parameter type: Range, 0.01 - 10 s | Setup: All setups             |
| Conversion index: -2                | Data type: Uint32                  | Change during operation: True |

Controls the dynamics of the feed-forward signal when ramping down.

## Parameter 7-56 Process PID Ref. Filter Time

Table 484: Parameter 7-56 Process PID Ref. Filter Time

| 7-56 Process PID Ref. Filter Time |                                    |                               |
|-----------------------------------|------------------------------------|-------------------------------|
| Default value: 0.001 s            | Parameter type: Range, 0.001 - 1 s | Setup: All setups             |
| Conversion index: -3              | Data type: Uint16                  | Change during operation: True |

Set a time constant for the reference first-order low-pass filter. The low-pass filter improves steady-state performance and dampens oscillations on the reference/feedback signals. However, severe filtering can be detrimental to dynamic performance.

## Parameter 7-57 Process PID Fb. Filter Time

Table 485: Parameter 7-57 Process PID Fb. Filter Time

| 7-57 Process PID Fb. Filter Time |                                    |                               |
|----------------------------------|------------------------------------|-------------------------------|
| Default value: 0.001 s           | Parameter type: Range, 0.001 - 1 s | Setup: All setups             |
| Conversion index: -3             | Data type: Uint16                  | Change during operation: True |

Set a time constant for the feedback first-order low-pass filter. The low-pass filter improves steady-state performance and dampens oscillations on the reference/ feedback signals. However, severe filtering can be detrimental to dynamic performance.

### 5.8.9 7-9\* Position PI Ctrl.

#### Parameter 7-90 Position PI Feedback Source

Table 486: Parameter 7-90 Position PI Feedback Source

| 7-90 Position PI Feedback Source      |                        |                               |
|---------------------------------------|------------------------|-------------------------------|
| Default value: [0] Motor feedb. P1-02 | Parameter type: Option | Setup: All setups             |
| Conversion index: –                   | Data type: Uint8       | Change during operation: True |

## N O T I C E

This parameter is only available with software version 48.XX.

Select the feedback source for the position PI controller.

| Op-tion | Name               | Description   |
|---------|--------------------|---|
| [0]*    | Motor feedb. P1-02 | Use the feedback source selected as motor feedback in <i>parameter 1-02 Flux Motor Feedback Source</i> .  |
| [1]     | 24V encoder 32/33  | Single signal generated from 24 V High Threshold Logic (HTL) encoder connected to terminals 32 and 33. Configure the 24 V encoder interface in <i>parameter group 5.7* 24V Encoder Input</i> . Program terminals 32/33 to [0] No operation. |
| [2]     | MCB 102            | This is only available for VLT® Encoder Option MCB 102. Configure the encoder interface in <i>parameter groups 17-0*, 17-1*, and 17-2*</i> .  |
| [3]     | MCB 103            | This is only available for VLT® Resolver Option MCB 103. Configure the resolver interface in <i>parameter group 17-5* Resolver Interface</i> .  |
| [4]     | MCO encoder 1 X56  | The MCO encoder 1 X56 is only available with motion control options MCO 305, MCO 350, and MCO 351. Configure the encoder interface in <i>parameter group 32-3* Encoder 1</i> .  |
| [5]     | MCO encoder 2 X55  | The MCO encoder 2 X55 is only available with motion control options MCO 305, MCO 350, and MCO 351. Configure the encoder interface in <i>parameter group 32-0* Encoder 2</i> .  |
| [11]    | MCB 15X            |   |
| [12]    | MCB 102 absolute   | The option is only available for VLT® Encoder Option MCB 102 with version 4.00 and newer and when <i>parameter 17-00 Encoders Connected</i> is set to [1] Two Encoders.   |
| [13]    | 24V encoder 27/29  | Single signal generated from 24 V High Threshold Logic (HTL) encoder connected to terminals 27 and 29. Configure the 24 V encoder interface in <i>parameter group 5.7* 24V Encoder Input</i> . Program terminals 27/29 to [0] No operation. |
| [20]    | None               | No position feedback is received. This means that actual position remains unchanged. For example, when the drive is used for operating a 2 <sup>nd</sup> motor without change in position via setup change.                                 |

#### Parameter 7-91 Position PI Droop

Table 487: Parameter 7-91 Position PI Droop

| 7-91 Position PI Droop |                                      |                               |
|------------------------|--------------------------------------|-------------------------------|
| Default value: 0.0 °   | Parameter type: Range, 0.0 - 360.0 ° | Setup: All setups             |
| Conversion index: -1   | Data type: Uint16                    | Change during operation: True |

## N O T I C E

This parameter is only available with software version 48.XX.

Enter the motor angle deviation at 100% load in a load sharing system. The system is 2 or more mechanically connected motors in positioning or synchronization mode. In positioning mode, configure *parameter 7-01 Speed PID Droop* to allow a speed deviation. Parameter 7-92 Position PI Proportional Gain

Table 488: Parameter 7-92 Position PI Proportional Gain

| 7-92 Position PI Proportional Gain |                                      |                               |
|------------------------------------|--------------------------------------|-------------------------------|
| Default value: 0.0150              | Parameter type: Range, 0.000 - 1.000 | Setup: All setups             |
| Conversion index: -4               | Data type: Uint32                    | Change during operation: True |

### N O T I C E

This parameter is only available with software version 48.XX.

Enter the proportional gain for the position PI controller. Increasing the gain value makes the control more dynamic but less stable. 0=Off.

Parameter 7-93 Position PI Integral Time

Table 489: Parameter 7-93 Position PI Integral Time

| 7-93 Position PI Integral Time |   |                               |
|--------------------------------|---|-------------------------------|
| Default value: 20000.0 ms      | Parameter type: Range, 1.0 - 20000.0 ms | Setup: All setups             |
| Conversion index: -4           | Data type: Uint32                       | Change during operation: True |

### N O T I C E

This parameter is only available with software version 48.XX.

Enter the integral time for the position PI controller. Decreasing the value makes the control more dynamic but less stable. 20000=Off.

Parameter 7-94 Position PI Feedback Scale Numerator

Table 490: Parameter 7-94 Position PI Feedback Scale Numerator

| 7-94 Position PI Feedback Scale Numerator |   |                               |
|---|---|-------------------------------|
| Default value: 1                          | Parameter type: Range, -2000000000 - 2000000000 | Setup: All setups             |
| Conversion index: 0                       | Data type: Int32                                | Change during operation: True |

### N O T I C E

This parameter is only available with software version 48.XX.

This parameter is the numerator in the equation which defines the gear ratio between the motor and the feedback device when the feedback device is not mounted on the motor shaft. Encoder revolutions =

$$\frac{\text{Par. 7-94}}{\text{Par. 7-95}} \times \text{Motor revolutions}$$

Parameter 7-95 Position PI Feedback Scale Denominator

Table 491: Parameter 7-95 Position PI Feedback Scale Denominator

| 7-95 Position PI Feedback Scale Denominator |   |                               |
|---|---|-------------------------------|
| Default value: 1                            | Parameter type: Range, -2000000000 - 2000000000 | Setup: All setups             |
| Conversion index: 0                         | Data type: Int32                                | Change during operation: True |

## N O T I C E

This parameter is only available with software version 48.XX.

See *parameter 7-94 Position PI Feedback Scale Numerator*.

Parameter 7-97 Position PI Max Speed Above Master

**Table 492: Parameter 7-97 Position PI Max Speed Above Master**

| 7-97 Position PI Max Speed Above Master |                                 |                               |
|---|---------------------------------|-------------------------------|
| Default value: 98%                      | Parameter type: Range, 0 - 110% | Setup: All setups             |
| Conversion index: 67                    | Data type: Uint16               | Change during operation: True |

## N O T I C E

This parameter is only available with software version 48.XX.

Enter the value by which the follower speed is allowed to exceed the actual master speed. Valid only in synchronization mode.

Parameter 7-98 Position PI Feed Forward Factor

**Table 493: Parameter 7-98 Position PI Feed Forward Factor**

| 7-98 Position PI Feed Forward Factor |                                 |                               |
|--------------------------------------|---------------------------------|-------------------------------|
| Default value: 98%                   | Parameter type: Range, 0 - 110% | Setup: All setups             |
| Conversion index: 0                  | Data type: Uint16               | Change during operation: True |

## N O T I C E

This parameter is only available with software version 48.XX.

Enter the amount by which the speed reference calculated by the profile generator is allowed to bypass the position PI controller.

Parameter 7-99 Position PI Minimum Ramp Time

**Table 494: Parameter 7-99 Position PI Minimum Ramp Time**

| 7-99 Position PI Minimum Ramp Time |   |                               |
|------------------------------------|---|-------------------------------|
| Default value: 0.010 s             | Parameter type: Range, 0.000 - 3600.000 s | Setup: All setups             |
| Conversion index: -3               | Data type: Uint32                         | Change during operation: True |

## N O T I C E

This parameter is only available with software version 48.XX.

Enter the shortest ramp time for the output of the Position PI controller. Use this parameter to limit acceleration when correcting large position deviations, for example when starting synchronization with a running master or after recovering from an overload situation during positioning.

## 5.9 Parameter Group 8-\*\* Communications and Options

### 5.9.1 8-0\* General Settings

#### Parameter 8-01 Control Site

Table 495: Parameter 8-01 Control Site

| 8-01 Control Site                         |                        |                               |
|---|------------------------|-------------------------------|
| Default value: [0] Digital and ctrl. word | Parameter type: Option | Setup: All setups             |
| Conversion index: –                       | Data type: Uint8       | Change during operation: True |

The setting in this parameter overrides the settings in *parameter 8-50 Coasting Select* to *parameter 8-56 Preset Reference Select*.

| Option | Name                  | Description                              |
|--------|-----------------------|--|
| [0]*   | Digital and ctrl.word | Use both digital input and control word. |
| [1]    | Digital only          | Use digital inputs only.                 |
| [2]    | Controlword only      | Use control word only.                   |

#### Parameter 8-02 Control Word Source

Table 496: Parameter 8-02 Control Word Source

| 8-02 Control Word Source    |                        |                               |
|-----------------------------|------------------------|-------------------------------|
| Default value: Size related | Parameter type: Option | Setup: All setups             |
| Conversion index: –         | Data type: Uint8       | Change during operation: True |

Select the source of the control word: 1 of 2 serial interfaces or 4 installed options. During initial power-up, the drive automatically sets this parameter to [3] *Option A* if it detects a valid fieldbus option installed in slot A. When the option is removed, the drive detects a configuration change, sets *parameter 8-02 Control Word Source* to default setting [1] *FC RS485*, and trips. If an option is installed after initial power-up, the setting of *parameter 8-02 Control Word Source* does not change, but the drive trips and shows: *Alarm 67, Option Changed*. When retrofitting a bus option into a drive that did not have a bus option installed earlier, change the control to bus-based. This change is required for safety reasons to avoid an unintended change.

| Option | Name          | Description   |
|--------|---------------|---|
| [0]    | None          |   |
| [1]    | FC RS485      |   |
| [2]    | FC USB        |   |
| [3]    | Option A      |   |
| [4]    | Option B      |   |
| [5]    | Option C0     |   |
| [6]    | Option C1     |   |
| [30]   | External Can  |   |
| [35]   | Option A fast | <div style="text-align: center; background-color: #cccccc; padding: 5px;"><b>NOTICE</b></div> <p>This option is only available in FC 302.</p> |

| Option | Name           | Description  |
|--------|----------------|--|
|        |                | Same as option [3] <i>Option A</i> . The reference is transferred faster and without jitter, which ensures more stability and dynamic control. Moreover, all other references are ignored, which means that the drive is controlled by the A-option reference only.  |
| [37]   | Option C0 fast | <div style="text-align: center; background-color: #cccccc; padding: 5px;"><b>NOTICE</b></div> <p>This option is only available in FC 302.</p> <p>Same as option [5] <i>Option C0</i>. The reference is transferred faster and without jitter, which ensures more stability and dynamic control. Moreover, all other references are ignored, which means that the drive is controlled by the C-option reference only.</p> |

Parameter 8-03 Control Word Timeout Time

Table 497: 8-03 Control Word Timeout Time

| 8-03 Control Word Timeout Time |                                      |                               |
|--------------------------------|--------------------------------------|-------------------------------|
| Default value: 1 s             | Parameter type: Range, 0.1 - 18000 s | Setup: 1 setup                |
| Conversion index: -1           | Data type: Uint32                    | Change during operation: True |

Enter the maximum time expected to pass between the reception of 2 consecutive telegrams. If this time is exceeded, it indicates that the serial communication has stopped. The function selected in *parameter 8-04 Control Word Timeout Function* is then carried out. A valid control word triggers the timeout counter.

Parameter 8-04 Control Word Timeout Function

Table 498: Parameter 8-04 Control Word Timeout Function

| 8-04 Control Word Timeout Function |                        |                               |
|------------------------------------|------------------------|-------------------------------|
| Default value: Size related        | Parameter type: Option | Setup: 1 setup                |
| Conversion index: –                | Data type: Uint8       | Change during operation: True |

Select the timeout function. The timeout function activates when the control word fails to be updated within the time period specified in *parameter 8-03 Control Word Timeout Time*.

**NOTICE**

To change the setup after a timeout, configure as follows:

- 1. Set *parameter 0-10 Active Set-up* to [9] *Multi setup*.
- 2. Select the relevant link in *parameter 0-12 This Set-up Linked to*.

| Option | Name          | Description  |
|--------|---------------|--|
| [0]    | Off           | Resumes control via fieldbus (fieldbus or standard), using the most recent control word. |
| [1]    | Freeze output | Freezes output frequency until communication resumes.                                    |
| [2]    | Stop          | Stops with auto restart when communication resumes.                                      |
| [3]    | Jogging       | Runs the motor at jog frequency until communication resumes.                             |
| [4]    | Max. speed    | Runs the motor at maximum frequency until communication resumes.                         |
| [5]    | Stop and trip | Stops the motor, then resets the drive to restart:                                       |



| Option | Name           | Description   |
|--------|----------------|---|
|        |                | <ul style="list-style-type: none"> <li>Via the fieldbus.</li> <li>Via [Reset].</li> <li>Via a digital input.</li> </ul>   |
| [6]    | Qstop and trip | <div style="text-align: center; background-color: #cccccc; padding: 5px;"><b>NOTICE</b></div> <p>This option is only available with software version 48.XX.</p> <p>Stops the motor with the quick stop ramp (<i>parameter 3-81 Quick Stop Ramp Time</i>). Perform a reset to restart the drive.</p> |
| [7]    | Select setup 1 | Changes the setup after a control word timeout. If communication resumes after a timeout, <i>parameter 8-05 End-of-Timeout Function</i> either resumes the setup used before the timeout, or retains the setup endorsed by the timeout function.  |
| [8]    | Select setup 2 | See [7] <i>Select set-up 1</i> .  |
| [9]    | Select setup 3 | See [7] <i>Select set-up 1</i> .  |
| [10]   | Select setup 4 | See [7] <i>Select set-up 1</i> .  |
| [26]   | Trip           |   |

Parameter 8-05 End-of-Timeout Function

Table 499: Parameter 8-05 End-of-Timeout Function

| 8-05 End-of-Timeout Function     |                        |                               |
|----------------------------------|------------------------|-------------------------------|
| Default value: [1] Resume set-up | Parameter type: Option | Setup: 1 setup                |
| Conversion index: –              | Data type: Uint8       | Change during operation: True |

Select the action after receiving a valid control word following a timeout. This parameter is active only when *parameter 8-04 Control Word Timeout Function* is set to:

- [7] Setup 1
- [8] Setup 2
- [9] Setup 3
- [10] Setup 4

| Option | Name         | Description  |
|--------|--------------|--|
| [0]    | Hold set-up  | Retains the setup selected in <i>parameter 8-04 Control Word Timeout Function</i> and shows a warning until <i>parameter 8-06 Reset Control Word Timeout</i> toggles. Then the drive resumes its original setup. |
| [1]*   | Resume setup | Resumes the setup that was active before the timeout.  |

Parameter 8-06 Reset Control Word Timeout

Table 500: Parameter 8-06 Reset Control Word Timeout

| 8-06 Reset Control Word Timeout |                        |                               |
|---------------------------------|------------------------|-------------------------------|
| Default value: [0] Do not reset | Parameter type: Option | Setup: All setups             |
| Conversion index: –             | Data type: Uint8       | Change during operation: True |

This parameter is active only when [0] *Hold set-up* has been selected in *parameter 8-05 End-of-Timeout Function*.

| Option | Name         | Description  |
|--------|--------------|--|
| [0]*   | Do not reset | Retains the setup specified in <i>parameter 8-04 Control Word Timeout Function</i> , following a control word timeout.   |
| [1]    | Do reset     | Restores the drive to the original setup following a control word timeout. The drive resets and then immediately reverts to the [0] <i>Do not reset</i> setting. |

Parameter 8-07 Diagnosis Trigger

Table 501: Parameter 8-07 Diagnosis Trigger

| 8-07 Diagnosis Trigger     |                        |                               |
|----------------------------|------------------------|-------------------------------|
| Default value: [0] Disable | Parameter type: Option | Setup: 2 setups               |
| Conversion index: –        | Data type: Uint8       | Change during operation: True |

This parameter has no function for DeviceNet.

| Option | Name                | Description |
|--------|---------------------|-------------|
| [0]*   | Disable             |             |
| [1]    | Trigger on alarms   |             |
| [2]    | Trigger alarm/warn. |             |

Parameter 8-08 Readout Filtering

Table 502: Parameter 8-08 Readout Filtering

| 8-08 Readout Filtering      |                                   |                               |
|-----------------------------|-----------------------------------|-------------------------------|
| Default value: Size related | Parameter type: Option, Array [1] | Setup: All setups             |
| Conversion index: –         | Data type: Uint8                  | Change during operation: True |

Use this function if the speed feedback value readouts on the fieldbus fluctuate. Select [1] *Motor Data LP-Filter* if the function is required. A power cycle is required for changes to take effect.

| Option | Name                 | Description  |
|--------|----------------------|--|
| [0]    | Motor data Std-Filt. | Normal fieldbus readouts.  |
| [1]    | Motor data LP-Filter | Filtered fieldbus readouts of the following parameters: <ul style="list-style-type: none"> <li>• <i>Parameter 16-10 Power [kW]</i></li> <li>• <i>Parameter 16-11 Power [hp]</i></li> <li>• <i>Parameter 16-12 Motor Voltage</i></li> <li>• <i>Parameter 16-14 Motor current</i></li> <li>• <i>Parameter 16-16 Torque [Nm]</i></li> <li>• <i>Parameter 16-17 Speed [RPM]</i></li> <li>• <i>Parameter 16-22 Torque [%]</i></li> <li>• <i>Parameter 16-25 Torque [Nm] High</i></li> </ul> |

### 5.9.2 8-1\* Ctrl. Word Settings

#### Parameter 8-10 Control Word Profile

Table 503: Parameter 8-10 Control Word Profile

| 8-10 Control Word Profile   |                        |                               |
|-----------------------------|------------------------|-------------------------------|
| Default value: Size related | Parameter type: Option | Setup: All setups             |
| Conversion index: -         | Data type: Uint8       | Change during operation: True |

Select the interpretation of the control and status words corresponding to the installed fieldbus. Only the selections valid for the fieldbus installed in slot A are visible in the LCP display. For guidelines in selection of [0] FC profile and [1] PROFIdrive profile, refer to the product-specific design guide. For more guidelines in the selection of [1] PROFIdrive profile, refer to the Installation Guide for the installed fieldbus.

| Option | Name               | Description   |
|--------|--------------------|---|
| [0]    | FC profile         |   |
| [1]    | PROFIdrive profile |   |
| [3]    | FC motion profile  | <div style="text-align: center; background-color: #cccccc; padding: 5px;"><b>NOTICE</b></div> <p>This option is only available with software version 48.XX.</p> <p>Assigns motion-specific functions to various control and status word bits. This option is available when [9] Positioning or [10] Synchronization is selected in parameter 1-00 Configuration Mode.</p> |
| [5]    | ODVA               |   |
| [7]    | CANopen DSP 402    |   |
| [8]    | MCO                |   |

#### Parameter 8-13 Configurable Status Word STW

Table 504: Parameter 8-13 Configurable Status Word STW

| 8-13 Configurable Status Word STW |                                    |                               |
|-----------------------------------|------------------------------------|-------------------------------|
| Default value: Size related       | Parameter type: Option, Array [16] | Setup: All setups             |
| Conversion index: -               | Data type: Uint8                   | Change during operation: True |

Select the interpretation of the control and status words corresponding to the installed fieldbus. Only the selections valid for the fieldbus installed in slot A are visible in the LCP display. For more guidelines in the selection of [1] PROFIdrive profile, refer to the Installation Guide for the installed fieldbus.

| Option | Name               | Description  |
|--------|--------------------|--|
| [0]    | No function        | The input is always low.   |
| [1]    | Profile default    | Dependent on the profile set in parameter 8-10 Control Profile.  |
| [2]    | Alarm 68 Only      | The input goes high whenever Alarm 68 Safe Stop Activated is active and goes low whenever Alarm 68 Safe Stop Activated is not activated. |
| [3]    | Trip excl Alarm 68 |  |

| Option | Name               | Description  |
|--------|--------------------|--|
| [4]    | Position error     | <p style="text-align: center;"><b>NOTICE</b></p> <p>This option is only available with software version 48.XX.</p> <p>The position is outside its limits set in <i>parameter 3-06 Minimum Position</i> and <i>parameter 3-07 Maximum Position</i>.</p>                     |
| [5]    | Position limit     | <p style="text-align: center;"><b>NOTICE</b></p> <p>This option is only available with software version 48.XX.</p> <p>The position error exceeds the value in <i>parameter 4-71 Maximum Position</i> for the time set in <i>parameter 4-72 Position Error Timeout</i>.</p> |
| [6]    | Touch on target    | <p style="text-align: center;"><b>NOTICE</b></p> <p>This option is only available with software version 48.XX.</p> <p>Target position is reached in touch probe position mode.</p>   |
| [7]    | Touch activated    | <p style="text-align: center;"><b>NOTICE</b></p> <p>This option is only available with software version 48.XX.</p> <p>Touch probe positioning is active. The drive monitors the touch probe sensor input.</p>  |
| [8]    | Touch sensor found | <p style="text-align: center;"><b>NOTICE</b></p> <p>This option is only available with software version 48.XX.</p> <p>The touch sensor has been detected.</p>  |
| [9]    | Vir. master on ref | <p style="text-align: center;"><b>NOTICE</b></p> <p>This option is only available with software version 48.XX.</p> <p>The virtual master is running on the set reference.</p>  |
| [10]   | T18DI status       |  |
| [11]   | T19DI status       |  |
| [12]   | T27DI status       |  |
| [13]   | T29DI status       |  |
| [14]   | T32DI status       |  |
| [15]   | T33DI status       |  |
| [16]   | T37DI status       | The input goes high whenever T37 has 0 V and goes low whenever T37 has 24 V.   |
| [17]   | X30/2 DI status    |  |
| [18]   | X30/3 DI status    |  |

| Option | Name                        | Description   |
|--------|-----------------------------|---|
| [19]   | X30/4 DI status             |   |
| [20]   | CTW timeout toggle inverse  |   |
| [21]   | Thermal warning             |   |
| [22]   | Execution distance extended | <div style="text-align: center; background-color: #cccccc; padding: 5px;"><b>NOTICE</b></div> <p>This option is only available with software version 48.9X.</p> <p>Indicates that the offset execution distance (set in <i>parameter 17-95 Offset Execution Distance</i>) has been extended due to speed/ramp limitation.</p> |
| [29]   | Protection mode             |   |
| [30]   | Brake fault (IGBT)          |   |
| [40]   | Out of ref range            |   |
| [49]   | Derate active               |   |
| [54]   | Running                     |   |
| [59]   | On reference                |   |
| [60]   | Comparator 0                |   |
| [61]   | Comparator 1                |   |
| [62]   | Comparator 2                |   |
| [63]   | Comparator 3                |   |
| [64]   | Comparator 4                |   |
| [65]   | Comparator 5                |   |
| [66]   | Comparator 6                |   |
| [67]   | Comparator 7                |   |
| [68]   | Comparator 8                |   |
| [69]   | Comparator 9                |   |
| [70]   | Logic rule 0                |   |
| [71]   | Logic rule 1                |   |
| [72]   | Logic rule 2                |   |
| [73]   | Logic rule 3                |   |
| [74]   | Logic rule 4                |   |
| [75]   | Logic rule 5                |   |
| [76]   | Logic rule 6                |   |
| [77]   | Logic rule 7                |   |
| [78]   | Logic rule 8                |   |

| Option | Name                   | Description   |
|--------|------------------------|---|
| [79]   | Logic rule 9           |   |
| [80]   | SL digital out A       |   |
| [81]   | SL digital out B       |   |
| [82]   | SL digital out C       |   |
| [83]   | SL digital out D       |   |
| [84]   | SL digital out E       |   |
| [85]   | SL digital out F       |   |
| [86]   | ATEX ETR cur. alarm    |   |
| [87]   | ATEX ETR freq. alarm   |   |
| [88]   | ATEX ETR cur. warning  |   |
| [89]   | ATEX ETR freq. warning |   |
| [90]   | Safe function active   |   |
| [91]   | Safe opt. reset. req.  |   |
| [92]   | IGBT-cooling           |   |
| [96]   | Reverse after ramp     | <p style="text-align: center;"><b>NOTICE</b></p> <p>This option is available only with software version 48.XX.</p> <p>Indicates if the direction of rotation should be reversed. Depends on whether the speed reference is positive or negative after the ramp specified in <i>parameter 16-48 Speed Ref. After Ramp [RPM]</i>.</p> |
| [181]  | Prev. maintenance      |   |
| [196]  | Emcy mode is active    | The drive is operating in emergency mode. See <i>parameter group 24-0* Emergency Mode</i> .   |
| [197]  | Emcy mode was active   | The drive has been operating in emergency mode.   |
| [198]  | Emcy mode limits       | During emergency mode operation, 1 of the critical alarms has been activated and suppressed by emergency mode. This may lead to reduced drive performance and expected operation lifetime before service is required.   |
| [200]  | User defined alerts    |   |
| [210]  | Pos. set acknowledge   | <p style="text-align: center;"><b>NOTICE</b></p> <p>This parameter is only available with software version 48.9X.</p> <p>Acknowledge activation of the set target position.</p>   |
| [231]  | In power lim. mot.     | <p style="text-align: center;"><b>NOTICE</b></p> <p>This option is only available in FC 302.</p> <p>See <i>parameter group 4-8* Power Limit</i>. Use this option in motor mode only.</p>  |

| Option | Name                   | Description  |
|--------|------------------------|--|
| [232]  | In power lim. gen.     | <p style="text-align: center;"><b>NOTICE</b></p> <p>This option is only available in FC 302.</p> <p>See <i>parameter group 4-8* Power Limit</i>. Use this option in generating mode only.</p>            |
| [233]  | In power limit         | <p style="text-align: center;"><b>NOTICE</b></p> <p>This option is only available in FC 302.</p> <p>See <i>parameter group 4-8* Power Limit</i>. Use this option in both motor and generating modes.</p> |
| [234]  | Emcy m. OPR unexpected | Emergency mode is not operating as expected, for example, live zero monitoring on an analog input is activated.  |
| [254]  | Testing emcy mode      | Emergency mode was activated in a special test mode where the drive stops on all alarms.   |

Parameter 8-14 Configurable Control Word CTW

Table 505: Parameter 8-14 Configurable Control Word CTW

| 8-14 Configurable Control Word CTW |                                    |                               |
|------------------------------------|------------------------------------|-------------------------------|
| Default value: [1] Profile default | Parameter type: Option, Array [16] | Setup: 2 setups               |
| Conversion index: -                | Data type: Uint8                   | Change during operation: True |

This is an array parameter with 16 elements, 1 element for each bit in range 0–15. Each of the bits can be configured to any of the following options.

| Option | Name                   | Description   |
|--------|------------------------|---|
| [0]    | None                   | The drive ignores the information in this bit.  |
| [1]*   | Profile default        | Dependent on the profile set in <i>parameter 8-10 Control Profile</i> .   |
| [2]    | CTW valid, active low  | If set to 1, the drive ignores the remaining bits of the control word.  |
| [3]    | Safe option reset      | This function is only available in bits 12–15 of the control word if a safety option is mounted in the drive. The reset is executed on a 0⇒1 transition and resets the safety option as set in <i>parameter 42-24 Restart behavior</i> .  |
| [4]    | PID error inverse      | Inverts the resulting error from the process PID controller. Available only if <i>parameter 1-00 Configuration Mode</i> is set to [6] <i>Surface Winder</i> , [7] <i>Extended PID Speed OL</i> , or [8] <i>Extended PID Speed CL</i> .  |
| [5]    | PID reset I part       | Resets the I-part of the process PID controller. Equivalent to <i>parameter 7-40 Process PID I-part Reset</i> . Available only if <i>parameter 1-00 Configuration Mode</i> is set to [6] <i>Surface Winder</i> , [7] <i>Extended PID Speed OL</i> , or [8] <i>Extended PID Speed CL</i> . |
| [6]    | PID enable             | Enables the extended process PID controller. Equivalent to <i>parameter 7-50 Process PID Extended PID</i> . Available only if <i>parameter 1-00 Configuration Mode</i> is set to [6] <i>Surface Winder</i> , [7] <i>Extended PID Speed OL</i> , or [8] <i>Extended PID Speed CL</i> .     |
| [7]    | External interlock     |   |
| [10]   | Bit 10 = 0>CTW timeout |   |

| Option | Name                        | Description  |
|--------|-----------------------------|--|
| [11]   | Start homing                | <p style="text-align: center;"><b>NOTICE</b></p> <p>This option is only available with software version 48.XX.</p> <p>Starts the homing function selected in <i>parameter 17-80 Homing Function</i>. Must remain high until homing is done, otherwise homing is aborted.</p>   |
| [12]   | Activate touch              | <p style="text-align: center;"><b>NOTICE</b></p> <p>This option is only available with software version 48.XX.</p> <p>Activates monitoring of the touch sensor input.</p>  |
| [13]   | Sync. to pos mode           | <p style="text-align: center;"><b>NOTICE</b></p> <p>This option is only available with software version 48.XX.</p> <p>Select positioning in synchronization mode.</p>  |
| [14]   | Ramp 2                      | <p style="text-align: center;"><b>NOTICE</b></p> <p>This option is only available with software version 48.XX.</p> <p>Select between ramp 1 (<i>parameter group 3-4* Ramp 1</i>) and ramp 2 (<i>parameter group 3-5* Ramp 2</i>).</p>  |
| [15]   | Relay 1                     | Control relay 1.   |
| [16]   | Relay 2                     | Control relay 1.   |
| [17]   | Speed mode                  | <p style="text-align: center;"><b>NOTICE</b></p> <p>This option is only available with software version 48.XX.</p> <p>Select the speed mode when [9] <i>Positioning</i> or [10] <i>Synchronization</i> is selected in <i>parameter 1-00 Configuration Mode</i>. Speed reference is set by reference resource 1 or fieldbus REF1 relative to <i>parameter 3-03 Maximum Reference</i>.</p> |
| [18]   | Enable vir. master          | <p style="text-align: center;"><b>NOTICE</b></p> <p>This option is only available with software version 48.XX.</p> <p>Enable the signal for the virtual master function. The option is applicable when [10] <i>Synchronization</i> is selected in <i>parameter 1-00 Configuration Mode</i>.</p>  |
| [19]   | Enable mast. off-set        | <p style="text-align: center;"><b>NOTICE</b></p> <p>This option is only available with software version 48.XX.</p> <p>Activates the master offset selected in <i>parameter 3-26 Master Offset</i> when <i>parameter 17-93 Master Offset Selection</i> has a selection from [1] <i>Absolute</i> to [5] <i>Relative Touch Sensor</i>.</p>  |
| [20]   | Control word toggle command | Changes the sign of the set target position. For example, if the set target is 1000, the activation of this option changes the value to -1000.   |



| Option | Name                 | Description  |
|--------|----------------------|--|
| [21]   | Target inverse       | <p style="text-align: center;"><b>NOTICE</b></p> <p>This option is only available with software version 48.XX.</p> <p>Changes the sign of the set target position. For example, if the set target is 1000, the activation of this option changes the value to -1000.</p>   |
| [22]   | Digital out 27       |  |
| [23]   | Digital out 29       |  |
| [24]   | Digital out X30/6    |  |
| [25]   | Digital out X30/7    |  |
| [26]   | Home sensor          | <p style="text-align: center;"><b>NOTICE</b></p> <p>This option is only available with software version 48.XX.</p> <p style="text-align: center;"><b>NOTICE</b></p> <p>Accuracy of the home position depends on the delay in transferring the signals.</p> <p>The home sensor is connected via fieldbus master.</p>  |
| [27]   | Touch sensor         | <p style="text-align: center;"><b>NOTICE</b></p> <p>This option is only available with software version 48.XX.</p> <p style="text-align: center;"><b>NOTICE</b></p> <p>Accuracy of touch probe positioning depends on the delay in transferring the signals.</p> <p>The touch sensor is connected via fieldbus master.</p>   |
| [28]   | Position vir. master | <p style="text-align: center;"><b>NOTICE</b></p> <p>This option is only available with software version 48.XX.</p> <p>Activates position-controlled virtual master when [9] Positioning or [10] Synchronization is selected in <i>parameter 1-00 Configuration Mode</i>. When the option is selected, the following occurs:</p> <ul style="list-style-type: none"> <li>• Target position is set by Fieldbus Pos Ref or preset target is as defined in <i>parameter 3-20 Preset Target</i>.</li> <li>• Speed is set relative to <i>parameter 3-27 Virtual Master Max Ref</i> by the source selected in <i>parameter 3-15 Reference Resource 1</i> or fieldbus REF1.</li> <li>• Acceleration and deceleration are set as defined in <i>parameter group 3-6* Ramp 3</i>.</li> </ul> |
| [29]   | Set master home      | <p style="text-align: center;"><b>NOTICE</b></p> <p>This option is only available with software version 48.XX.</p> <p>Sets the actual master position as defined in <i>parameter 17-88 Master Home Position</i>.</p>   |

| Option | Name                              | Description   |
|--------|-----------------------------------|---|
| [30]   | Set vir. mas. pos. to actual      | <p style="text-align: center;"><b>NOTICE</b></p> <p>This option is only available with software version 48.XX.</p> <p>Bit for setting the virtual master position = the actual follower position. This is needed for setting the correct starting position for position-controlled virtual master ensuring that the virtual master ensuring that the virtual master position is aligned with the physical position of the follower.</p> |
| [31]   | Activate CAM table                | <p style="text-align: center;"><b>NOTICE</b></p> <p>This option is only available with software version 48.XX.</p> <p>Signal for activating a new CAM table while running with bumpless transfer.</p>   |
| [32]   | Halt                              |   |
| [33]   | Bit 10 = 0 > CTW TO always        |   |
| [78]   | Reset preventive maintenance word |   |
| [94]   | Light load detection              | Use this option to ensure drive runs in the direction which requires least energy (UPS capacity), during an emergency.  |
| [95]   | Evacuation mode                   | Use this function to operate the drive at reduced DC voltage for evacuating people in case of power failure.  |
| [189]  | Emergency mode                    |   |
| [190]  | Emcy mode ref bit 0               | Enables a choice between 1 of the 8 preset references.  |
| [191]  | Emcy mode ref bit 1               | Enables a choice between 1 of the 8 preset references.  |
| [192]  | Emcy mode ref bit 2               | Enables a choice between 1 of the 8 preset references.  |
| [195]  | Test emcy mode                    | Emergency mode is activated in a special test mode where the drive stops on all alarms.   |
| [231]  | Power limit mot.                  | <p style="text-align: center;"><b>NOTICE</b></p> <p>This option is only available in FC 302.</p> <p>See <i>parameter group 4-8* Power Limit</i>. Use this option in the motor mode only.</p>  |
| [232]  | Power limit gen.                  | <p style="text-align: center;"><b>NOTICE</b></p> <p>This option is only available in FC 302.</p> <p>See <i>parameter group 4-8* Power Limit</i>. Use this option in the generating mode only.</p>   |

| Option | Name                  | Description   |
|--------|-----------------------|---|
| [233]  | Power limit both      | <p style="text-align: center;"><b>NOTICE</b></p> <p>This option is only available in FC 302.</p> <p>See <i>parameter group 4-8* Power Limit</i>. Use this option in both the motor and the generating modes.</p>  |
| [234]  | Light load+evacuation | <p style="text-align: center;"><b>NOTICE</b></p> <p>This option is only available in FC 302.</p> <p>Use this option to ensure that the drive runs in the direction which requires least energy (UPS capacity), during an emergency and to operate the drive at reduced DC-voltage for evacuating people in case of power failure.</p> |
| [235]  | Setup bit 0           |   |
| [236]  | Setup bit 1           |   |

Parameter 8-17 Configurable Alarm and Warning Word

Table 506: Parameter 8-17 Configurable Alarm and Warningword

| 8-17 Configurable Alarm and Warningword |                                    |                               |
|---|------------------------------------|-------------------------------|
| Default value: [0] Off                  | Parameter type: Option, Array [16] | Setup: All setups             |
| Conversion index: -                     | Data type: Uint16                  | Change during operation: True |

The configurable alarm and warning word has 16 bits (0–15). Each of those bits can be configured to any of the following options.

| Option | Name                              | Description |
|--------|-----------------------------------|-------------|
| [0]*   | Off                               |             |
| [1]    | 10 Volts low warning              |             |
| [2]    | Live zero warning                 |             |
| [3]    | No motor warning                  |             |
| [4]    | Mains phase loss warning          |             |
| [5]    | DC link voltage high warning      |             |
| [6]    | DC link voltage low warning       |             |
| [7]    | DC overvoltage warning            |             |
| [8]    | DC undervoltage warning           |             |
| [9]    | Inverter overloaded warning       |             |
| [10]   | Motor ETR overtemp warning        |             |
| [11]   | Motor thermistor overtemp warning |             |
| [12]   | Torque limit warning              |             |
| [13]   | Over current warning              |             |

| Option | Name                                 | Description |
|--------|--------------------------------------|-------------|
| [14]   | Earth fault warning                  |             |
| [17]   | Controlword timeout warning          |             |
| [19]   | Discharge temp high warning          |             |
| [22]   | Hoist mech brake warning             |             |
| [23]   | Internal fans warning                |             |
| [24]   | External fans warning                |             |
| [25]   | Brake resistor short circuit warning |             |
| [26]   | Brake powerlimit warning             |             |
| [27]   | Brake chopper short circuit warning  |             |
| [28]   | Brake check warning                  |             |
| [29]   | Heatsink temperature warning         |             |
| [30]   | Motor phase U warning                |             |
| [31]   | Motor phase V warning                |             |
| [32]   | Motor phase W warning                |             |
| [34]   | Fieldbus communication warning       |             |
| [36]   | Mains failure warning                |             |
| [40]   | T27 overload warning                 |             |
| [41]   | T29 overload warning                 |             |
| [45]   | Earth fault 2 warning                |             |
| [47]   | 24V supply low warning               |             |
| [58]   | AMA internal fault warning           |             |
| [59]   | Current limit warning                |             |
| [60]   | External interlock warning           |             |
| [61]   | Feedback error warning               |             |
| [62]   | Frequency max warning                |             |
| [64]   | Voltage limit warning                |             |
| [65]   | Controlboard overtemp warning        |             |
| [66]   | Heatsink temp low warning            |             |
| [68]   | Safe stop warning                    |             |
| [73]   | Safe stop autorestart warning        |             |
| [76]   | Power unit setup warning             |             |
| [77]   | Reduced powermode warning            |             |

| Option  | Name                            | Description |
|---------|---------------------------------|-------------|
| [78]    | Tracking error warning          |             |
| [89]    | Mech brake sliding warning      |             |
| [10002] | Live zero error alarm           |             |
| [10003] | No motor alarm                  |             |
| [10004] | Mains phase loss alarm          |             |
| [10007] | DC overvoltage alarm            |             |
| [10008] | DC undervoltage alarm           |             |
| [10009] | Inverter overload alarm         |             |
| [10010] | ETR overtemperature alarm       |             |
| [10011] | Thermistor overtemp alarm       |             |
| [10012] | Torque limit alarm              |             |
| [10013] | Overcurrent alarm               |             |
| [10014] | Earth fault alarm               |             |
| [10016] | Short circuit alarm             |             |
| [10017] | CTW timeout alarm               |             |
| [10022] | Hoist brake alarm               |             |
| [10026] | Brake powerlimit alarm          |             |
| [10027] | Brakechopper shortcircuit alarm |             |
| [10028] | Brake check alarm               |             |
| [10029] | Heatsink temp alarm             |             |
| [10030] | Phase U missing alarm           |             |
| [10031] | Phase V missing alarm           |             |
| [10032] | Phase W missing alarm           |             |
| [10033] | Inrush fault alarm              |             |
| [10034] | Fieldbus com fault alarm        |             |
| [10036] | Mains failure alarm             |             |
| [10037] | Phase imbalance alarm           |             |
| [10038] | Internal fault                  |             |
| [10039] | Heatsink sensor alarm           |             |
| [10045] | Earth fault 2 alarm             |             |
| [10046] | Powercard supply alarm          |             |
| [10047] | 24V supply alarm                |             |

| Option  | Name                        | Description |
|---------|-----------------------------|-------------|
| [10048] | 1.8V supply low alarm       |             |
| [10049] | Speed limit alarm           |             |
| [10060] | Ext interlock alarm         |             |
| [10061] | Feedback error alarm        |             |
| [10063] | Mech brake low alarm        |             |
| [10065] | Controlboard overtemp alarm |             |
| [10067] | Option config changed alarm |             |
| [10068] | Safe stop alarm             |             |
| [10069] | Powercard temp alarm        |             |
| [10073] | Safestop auto restart alarm |             |
| [10074] | PTC thermistor alarm        |             |
| [10075] | Illegal profile alarm       |             |
| [10078] | Tracking error alarm        |             |
| [10079] | Illegal PS config alarm     |             |
| [10081] | CSIV corrupt alarm          |             |
| [10082] | CSIV param error alarm      |             |
| [10084] | No safety option alarm      |             |
| [10090] | Feedback monitor alarm      |             |
| [10091] | AI54 settings alarm         |             |
| [10164] | ATEX ETR current lim alarm  |             |
| [10166] | ATEX ETR freq limit alarm   |             |

## Parameter 8-19 Product Code

Table 507: Parameter 8-19 Product Code

| 8-19 Product Code           |  |                               |
|-----------------------------|--|-------------------------------|
| Default value: Size related | Parameter type: Range, 0 - 2147483647, Array [2] | Setup: 1 setup                |
| Conversion index: 0         | Data type: Uint32                                | Change during operation: True |

Select 0 to read out the actual fieldbus product code according to the mounted fieldbus option. Select 1 to read out the actual vendor ID.

### 5.9.3 8-2\* Counters

#### Parameter 8-20: Invalid Memory Write Counter

Table 508: Parameter 8-20: Invalid Memory Write Counter

| 8-20: Invalid Memory Write Counter |                                   |                               |
|------------------------------------|-----------------------------------|-------------------------------|
| Default value: 0                   | Parameter type: Range (0 - 65535) | 4-setup: 1 setup              |
| Conversion index: -                | Data type: Uint8                  | Change during operation: True |

### 5.9.4 8-3\* FC Port Settings

#### Parameter 8-30 Protocol

Table 509: Parameter 8-30 Protocol

| 8-30 Protocol         |                        |                               |
|-----------------------|------------------------|-------------------------------|
| Default value: [0] FC | Parameter type: Option | Setup: 1 setup                |
| Conversion index: -   | Data type: Uint8       | Change during operation: True |

Select the protocol to be used. Changing protocol is not effective until after powering off the drive.

| Option | Name       | Description |
|--------|------------|-------------|
| [0]*   | FC         |             |
| [1]    | FC MC      |             |
| [2]    | Modbus RTU |             |

#### Parameter 8-31 Address

Table 510: Parameter 8-31 Address

| 8-31 Address        |                                |                               |
|---------------------|--------------------------------|-------------------------------|
| Default value: 1    | Parameter type: Range, 1 - 247 | Setup: 1 setup                |
| Conversion index: 0 | Data type: Uint8               | Change during operation: True |

Enter the address for the drive (standard) port. Valid range: Depends on the selected protocol.

#### Parameter 8-32 FC Port Baud Rate

Table 511: Parameter 8-32 FC Port Baud Rate

| 8-32 FC Port Baud Rate      |                        |                               |
|-----------------------------|------------------------|-------------------------------|
| Default value: Size related | Parameter type: Option | Setup: 1 setup                |
| Conversion index: -         | Data type: Uint8       | Change during operation: True |

| Option | Name       | Description                                     |
|--------|------------|---|
| [0]    | 2400 Baud  | Baud rate selection for the FC (standard) port. |
| [1]    | 4800 Baud  |   |
| [2]    | 9600 Baud  |   |
| [3]    | 19200 Baud |   |
| [4]    | 38400 Baud |   |

| Option | Name        | Description |
|--------|-------------|-------------|
| [5]    | 57600 Baud  |             |
| [6]    | 76800 Baud  |             |
| [7]    | 115200 Baud |             |

## Parameter 8-33 Parity/Stop Bits

Table 512: Parameter 8-33 Parity/Stop Bits

| 8-33 Parity/Stop Bits                      |                        |                               |
|--|------------------------|-------------------------------|
| Default value: [0] Even parity, 1 stop bit | Parameter type: Option | Setup: 1 setup                |
| Conversion index: –                        | Data type: Uint8       | Change during operation: True |

| Option | Name                    | Description |
|--------|-------------------------|-------------|
| [0]*   | Even parity, 1 stop bit |             |
| [1]    | Odd parity, 1 stop bit  |             |
| [2]    | No parity, 1 stop bit   |             |
| [3]    | No parity, 2 stop bits  |             |

## Parameter 8-34 Estimated Cycle Time

Table 513: Parameter 8-34 Estimated Cycle Time

| 8-34 Estimated Cycle Time |                                       |                               |
|---------------------------|---------------------------------------|-------------------------------|
| Default value: 0 ms       | Parameter type: Range, 0 - 1000000 ms | Setup: 2 setups               |
| Conversion index: -3      | Data type: Uint32                     | Change during operation: True |

In noisy environments, the interface may be blocked due to overload or bad frames. This parameter specifies the time between 2 consecutive frames on the network. If the interface does not detect valid frames in that time, it flushes the receive buffer.

## Parameter 8-35 Minimum Response Delay

Table 514: Parameter 8-35 Minimum Response Delay

| 8-35 Minimum Response Delay |                                     |                               |
|-----------------------------|-------------------------------------|-------------------------------|
| Default value: 10 ms        | Parameter type: Range, 1 - 10000 ms | Setup: 1 setup                |
| Conversion index: -3        | Data type: Uint16                   | Change during operation: True |

Specify the minimum delay time between receiving a request and transmitting a response. This is used for overcoming modem turnaround delays.

## Parameter 8-36 Max Response Delay

Table 515: Parameter 8-36 Max Response Delay

| 8-36 Max Response Delay     |                                      |                               |
|-----------------------------|--------------------------------------|-------------------------------|
| Default value: Size related | Parameter type: Range, 11 - 10001 ms | Setup: 1 setup                |
| Conversion index: -3        | Data type: Uint16                    | Change during operation: True |

Specify the maximum allowed delay time between transmitting a request and receiving a response. If a response from the drive exceeds the time setting, then it is discarded.



## Parameter 8-37 Max Inter-Char Delay

Table 516: Parameter 8-37 Max Inter-Char Delay

| 8-37 Max Inter-Char Delay   |  |                               |
|-----------------------------|--|-------------------------------|
| Default value: Size related | Parameter type: Range, 0.00 - 35.00 ms | Setup: 1 setup                |
| Conversion index: -5        | Data type: Uint16                      | Change during operation: True |

Specify the maximum allowed time interval between receipt of 2 bytes. This parameter activates timeout if transmission is interrupted. This parameter is active only when *parameter 8-30 Protocol* is set to [1] *FC MC protocol*.

## Parameter 8-39 Protocol/Profile Firmware Version

Table 517: Parameter 8-39 Protocol/Profile Firmware Version

| 8-39 Protocol/Profile Firmware Version |  |                                |
|--|--|--------------------------------|
| Default value: 0                       | Parameter type: Range, 0 - 10, Array [8] | Setup: All setups              |
| Conversion index: 0                    | Data type: VisibleString [10]            | Change during operation: False |

This parameter shows the firmware revision as follows:

- Index [0] = FC
- Index [1] = Modbus
- Index [2] = Metasys N2
- Index [3] = FLN
- Index [4] = BACnet
- Index [5] = Future native protocol
- Index [6] = PROFIdrive profile
- Index [7] = DS402 profile

## 5.9.5 8-4\* FC MC Protocol Set

## Parameter 8-40 Telegram Selection

Table 518: Parameter 8-40 Telegram Selection

| 8-40 Telegram Selection                |                        |                               |
|--|------------------------|-------------------------------|
| Default value: [1] Standard telegram 1 | Parameter type: Option | Setup: 2 setups               |
| Conversion index: -                    | Data type: Uint8       | Change during operation: True |

| Option | Name                | Description   |
|--------|---------------------|---|
| [1]*   | Standard telegram 1 | Enables use of freely configurable telegrams or standard telegrams for the FC port. |
| [100]  | None                |   |
| [101]  | PPO 1               |   |
| [102]  | PPO 2               |   |
| [103]  | PPO 3               |   |
| [104]  | PPO 4               |   |
| [105]  | PPO 5               |   |
| [106]  | PPO 6               |   |
| [107]  | PPO 7               |   |

| Option | Name              | Description   |
|--------|-------------------|---|
| [108]  | PPO 8             |   |
| [200]  | Custom telegram 1 | Enables use of freely configurable telegrams or standard telegrams for the FC port. |
| [202]  | Custom telegram 3 |   |

## Parameter 8-41 Parameters for Signals

Table 519: Parameter 8-41 Parameters for Signals

| 8-41 Parameters for Signals |                                      |                                |
|-----------------------------|--------------------------------------|--------------------------------|
| Default value: [0] None     | Parameter type: Option, Array [1000] | Setup: All setups              |
| Conversion index: –         | Data type: Uint16                    | Change during operation: False |

| Option | Name                         | Description |
|--------|------------------------------|-------------|
| [0]*   | None                         |             |
| [15]   | Readout: actual setup        |             |
| [302]  | Minimum reference            |             |
| [303]  | Maximum reference            |             |
| [312]  | Catch up/slow down value     |             |
| [321]  | Touch target                 |             |
| [322]  | Master scale numerator       |             |
| [323]  | Master scale denominator     |             |
| [326]  | Master offset                |             |
| [328]  | Master offset speed ref      |             |
| [341]  | Ramp 1 ramp up time          |             |
| [342]  | Ramp 1 ramp down time        |             |
| [351]  | Ramp 2 ramp up time          |             |
| [352]  | Ramp 2 ramp down time        |             |
| [380]  | Jog/homing ramp time         |             |
| [381]  | Quick stop ramp time         |             |
| [411]  | Motor speed low limit [RPM]  |             |
| [412]  | Motor speed low limit [Hz]   |             |
| [413]  | Motor speed high limit [RPM] |             |
| [414]  | Motor speed high limit [Hz]  |             |
| [416]  | Torque limit motor mode      |             |
| [417]  | Torque limit generator mode  |             |
| [482]  | Power limit motor mode       |             |

| Option | Name                               | Description |
|--------|------------------------------------|-------------|
| [483]  | Power limit generator mode         |             |
| [491]  | Positive speed limit [RPM]         |             |
| [492]  | Positive speed limit [Hz]          |             |
| [493]  | Negative speed limit [RPM]         |             |
| [494]  | Negative speed limit [Hz]          |             |
| [495]  | Positive torque limit              |             |
| [496]  | Negative torque limit              |             |
| [553]  | Term. 29 high ref./feedb. value    |             |
| [558]  | Term. 33 high ref./feedb. value    |             |
| [590]  | Digital & relay bus control        |             |
| [593]  | Pulse out #27 bus control          |             |
| [595]  | Pulse out #29 bus control          |             |
| [597]  | Pulse out #X30/6 bus control       |             |
| [615]  | Terminal 53 high ref./feedb. value |             |
| [625]  | Terminal 54 high ref./feedb. value |             |
| [653]  | Term 42 output bus ctrl            |             |
| [663]  | Terminal X30/8 bus control         |             |
| [673]  | Terminal X54/1 bus control         |             |
| [683]  | Terminal X54/3 bus control         |             |
| [702]  | Speed PID proportional gain        |             |
| [703]  | Speed PID integral time            |             |
| [708]  | Speed PID feed forward factor      |             |
| [748]  | PCD feed forward                   |             |
| [890]  | Bus jog 1 speed                    |             |
| [891]  | Bus jog 2 speed                    |             |
| [1397] | Alert alarm word                   |             |
| [1398] | Alert warning word                 |             |
| [1399] | Alert status word                  |             |
| [1472] | Legacy alarm word                  |             |
| [1473] | Legacy warning word                |             |
| [1474] | Leg. ext. status word              |             |
| [1500] | Operating hours                    |             |

| Option | Name                          | Description |
|--------|-------------------------------|-------------|
| [1501] | Running hours                 |             |
| [1502] | kWh counter                   |             |
| [1600] | Control word                  |             |
| [1601] | Reference [unit]              |             |
| [1602] | Reference %                   |             |
| [1603] | Status word                   |             |
| [1605] | Main actual value [%]         |             |
| [1606] | Actual position               |             |
| [1607] | Target position               |             |
| [1608] | Position error                |             |
| [1609] | Custom readout                |             |
| [1610] | Power [kW]                    |             |
| [1611] | Power [hp]                    |             |
| [1612] | Motor voltage                 |             |
| [1613] | Frequency                     |             |
| [1614] | Motor current                 |             |
| [1615] | Frequency [%]                 |             |
| [1616] | Torque [Nm]                   |             |
| [1617] | Speed [RPM]                   |             |
| [1618] | Motor thermal                 |             |
| [1619] | Thermistor sensor temperature |             |
| [1620] | Motor angle                   |             |
| [1621] | Torque [%] high res.          |             |
| [1622] | Torque [%]                    |             |
| [1623] | Motor shaft power [kW]        |             |
| [1624] | Calibrated                    |             |
| [1625] | Torque [Nm] high              |             |
| [1628] | Angle error                   |             |
| [1630] | DC link voltage               |             |
| [1632] | Brake energy /s               |             |
| [1633] | Brake energy average          |             |
| [1634] | Heatsink temp.                |             |

| Option | Name                        | Description |
|--------|-----------------------------|-------------|
| [1635] | Inverter thermal            |             |
| [1638] | SL controller state         |             |
| [1639] | Control card temp.          |             |
| [1642] | Service log counter         |             |
| [1644] | Speed error [RPM]           |             |
| [1645] | Motor phase U current       |             |
| [1646] | Motor phase V current       |             |
| [1647] | Motor phase W current       |             |
| [1648] | Speed ref. after ramp [RPM] |             |
| [1650] | External reference          |             |
| [1651] | Pulse reference             |             |
| [1652] | Feedback [Unit]             |             |
| [1653] | Digi pot reference          |             |
| [1657] | Feedback [RPM]              |             |
| [1660] | Digital input               |             |
| [1661] | Terminal 53 switch setting  |             |
| [1662] | Analog input 53             |             |
| [1663] | Terminal 54 switch setting  |             |
| [1664] | Analog input 54             |             |
| [1665] | Analog output 42 [mA]       |             |
| [1666] | Digital output [bin]        |             |
| [1667] | Freq. input #29 [Hz]        |             |
| [1668] | Freq. input #33 [Hz]        |             |
| [1669] | Pulse output #27 [Hz]       |             |
| [1670] | Pulse output #29 [Hz]       |             |
| [1671] | Relay output [bin]          |             |
| [1672] | Counter A                   |             |
| [1673] | Counter B                   |             |
| [1674] | Prec. stop counter          |             |
| [1675] | Analog in X30/11            |             |
| [1676] | Analog in X30/12            |             |
| [1677] | Analog out X30/8 [mA]       |             |

| Option | Name                            | Description |
|--------|---------------------------------|-------------|
| [1678] | Analog out X45/1 [mA]           |             |
| [1679] | Analog out X45/3 [mA]           |             |
| [1680] | Fieldbus CTW 1                  |             |
| [1681] | Fieldbus sync. REF              |             |
| [1682] | Fieldbus REF 1                  |             |
| [1683] | Fieldbus pos. REF               |             |
| [1684] | Comm. option STW                |             |
| [1685] | FC port CTW 1                   |             |
| [1686] | FC port REF 1                   |             |
| [1687] | Bus readout alarm/warning       |             |
| [1688] | Fieldbus torque FF              |             |
| [1689] | Configurable alarm/warning word |             |
| [1690] | Alarm word                      |             |
| [1691] | Alarm word 2                    |             |
| [1692] | Warning word                    |             |
| [1693] | Warning word 2                  |             |
| [1694] | Ext. status word                |             |
| [1695] | Ext. status word 2              |             |
| [1696] | Maintenance word                |             |
| [1697] | Alarm word 3                    |             |
| [1698] | Warning word 3                  |             |
| [1782] | Home position                   |             |
| [1783] | Homing speed                    |             |
| [1788] | Master home position            |             |
| [1804] | Mech brake count                |             |
| [1820] | Commanded position              |             |
| [1821] | Master position                 |             |
| [1823] | Virtual master pos.             |             |
| [1826] | Fieldbus sync. delta REF        |             |
| [1827] | Safe opt. est. speed            |             |
| [1828] | Safe opt. meas. speed           |             |
| [1829] | Safe opt. speed error           |             |

| Option | Name                       | Description |
|--------|----------------------------|-------------|
| [1836] | Analog input X48/2 [mA]    |             |
| [1837] | Temp. input X48/4          |             |
| [1838] | Temp. input X48/7          |             |
| [1839] | Temp. input X48/10         |             |
| [1840] | Analog input X49/1         |             |
| [1841] | Analog input X49/3         |             |
| [1842] | Analog input X49/5         |             |
| [1843] | Analog out X49/7           |             |
| [1844] | Analog out X49/9           |             |
| [1845] | Analog out X49/11          |             |
| [1846] | X49 digital output [bin]   |             |
| [1860] | Digital input 2            |             |
| [1899] | Speed PID torque FF. [Nm]  |             |
| [3310] | Sync factor master         |             |
| [3311] | Sync factor slave          |             |
| [3440] | Digital inputs             |             |
| [3441] | Digital outputs            |             |
| [3450] | Actual position            |             |
| [3451] | Commanded position         |             |
| [3452] | Actual master position     |             |
| [3453] | Slave index position       |             |
| [3454] | Master index position      |             |
| [3455] | Curve position             |             |
| [3456] | Track error                |             |
| [3457] | Synchronizing error        |             |
| [3458] | Actual velocity            |             |
| [3459] | Actual master velocity     |             |
| [3460] | Synchronizing status       |             |
| [3461] | Axis status                |             |
| [3462] | Program status             |             |
| [3644] | Terminal X49/7 bus control |             |
| [3654] | Terminal X49/9 bus control |             |

| Option | Name                         | Description |
|--------|------------------------------|-------------|
| [3664] | Terminal X49/11 bus control  |             |
| [4029] | B-EMF protection log readout |             |
| [4280] | Safe option status           |             |
| [4282] | Safe control word            |             |
| [4283] | Safe status word             |             |
| [4285] | Active safe func.            |             |
| [4287] | Time until manual test       |             |

### Parameter 8-42 PCD Write Configuration

Table 520: Parameter 8-42 PCD Write Configuration

| 8-42 PCD Write Configuration |   |                               |
|------------------------------|---|-------------------------------|
| Default value: Size related  | Parameter type: Range, 0 - 9999, Array [64] | Setup: 2 setups               |
| Conversion index: 0          | Data type: Uint16                           | Change during operation: True |

Select the parameters to be assigned to the telegrams of the PCD. The number of available PCDs depends on the telegram type. The values in the PCDs are then written to the selected parameters as data values.

### Parameter 8-43 PCD Read Configuration

Table 521: Parameter 8-43 PCD Read Configuration

| 8-43 PCD Read Configuration |   |                               |
|-----------------------------|---|-------------------------------|
| Default value: Size related | Parameter type: Range, 0 - 9999, Array [64] | Setup: 2 setups               |
| Conversion index: 0         | Data type: Uint16                           | Change during operation: True |

Select the parameters to be assigned to the PCDs of the telegrams. The number of available PCDs depends on the telegram type. PCDs contain the actual data values of the selected parameters.

### Block Transfer Mode (BTM)

When Block Transfer Mode (BTM) is enabled, the parameters are written into a temporary buffer in the drive via the fieldbus. After wiring all the required parameters to the drive in BTM mode, a Commit command is sent to the drive. The drive ensures correct adaptation of the parameters.

### Parameter 8-45 BTM Transaction Command

Table 522: Parameter 8-45 BTM Transaction Command

| 8-45 BTM Transaction Command |                        |                                |
|------------------------------|------------------------|--------------------------------|
| Default value: [0] Off       | Parameter type: Option | Setup: All setups              |
| Conversion index: –          | Data type: Uint8       | Change during operation: False |

## NOTICE

This parameter cannot be adjusted while the motor is running.

| Option | Name                  | Description |
|--------|-----------------------|-------------|
| [0]*   | Off                   |             |
| [1]    | Write to active setup |             |



| Option | Name                   | Description  |
|--------|------------------------|--|
| [2]    | Commit transaction     | Commit all parameters that have been sent during BTM mode.   |
| [3]    | Clear error            | When <i>parameter 8-46 BTM Transaction Status</i> shows an error (3–8), the parameter must be cleared by setting this value.   |
| [4]    | Write to setup 1       | <p style="text-align: center;"><b>NOTICE</b></p> <p>This option is only available with software version 9.XX.</p>  |
| [5]    | Write to setup 2       | <p style="text-align: center;"><b>NOTICE</b></p> <p>This option is only available with software version 9.XX.</p>  |
| [6]    | Write to setup 3       | <p style="text-align: center;"><b>NOTICE</b></p> <p>This option is only available with software version 9.XX.</p>  |
| [7]    | Write to setup 4       | <p style="text-align: center;"><b>NOTICE</b></p> <p>This option is only available with software version 9.XX.</p>  |
| [8]    | Cancel BTM transaction | <p style="text-align: center;"><b>NOTICE</b></p> <p>This option is only available with software version 9.XX.</p> <p>Abort any BTM activity. Parameters are not committed.</p> |

Parameter 8-46 BTM Transaction Status

Table 523: Parameter 8-46 BTM Transaction Status

| 8-46 BTM Transaction Status |                        |                               |
|-----------------------------|------------------------|-------------------------------|
| Default value: [0] Off      | Parameter type: Option | Setup: All setups             |
| Conversion index: –         | Data type: Uint8       | Change during operation: True |

| Option | Name                   | Description |
|--------|------------------------|-------------|
| [0]*   | Off                    |             |
| [1]    | Transaction started    |             |
| [2]    | Commit transaction     |             |
| [3]    | Transaction timeout    |             |
| [4]    | Err. non-existing par. |             |
| [5]    | Err. par. out of range |             |

| Option | Name                 | Description |
|--------|----------------------|-------------|
| [6]    | Transaction failed   |             |
| [7]    | SO config check      |             |
| [8]    | SO config check done |             |

## Parameter 8-47 BTM Timeout

Table 524: Parameter 8-47 BTM Timeout

| 8-47 BTM Timeout    |                                  |                                |
|---------------------|----------------------------------|--------------------------------|
| Default value: 60 s | Parameter type: Range, 1 - 360 s | Setup: 1 setup                 |
| Conversion index: 0 | Data type: Uint16                | Change during operation: False |

Select the BTM timeout after a BTM transaction has been started. Timeout is between each acyclic write of parameters.

## Parameter 8-48 BTM Maximum Errors

Table 525: Parameter 8-48 BTM Maximum Errors

| 8-48 BTM Maximum Errors |                               |                               |
|-------------------------|-------------------------------|-------------------------------|
| Default value: 21       | Parameter type: Range, 0 - 21 | Setup: 1 setup                |
| Conversion index: 0     | Data type: Uint8              | Change during operation: True |

Select the maximum allowed number of bulk transfer mode errors before aborting. If it is set to maximum, there is no abort.

## Parameter 8-49 BTM Error Log

Table 526: Parameter 8-49 BTM Error Log

| 8-49 BTM Error Log          |   |                               |
|-----------------------------|---|-------------------------------|
| Default value: Size related | Parameter type: Range, 0.000 - 9999.255, Array [22] | Setup: 1 setup                |
| Conversion index: -3        | Data type: Uint32                                   | Change during operation: True |

List of parameters that failed during bulk transfer mode. The value after the decimal break is the fault code (255 stands for no error).

## 5.9.6 8-5\* Digital/Bus

Parameters for configuring the control word merging.

## N O T I C E

These parameters are only active when *parameter 8-01 Control Site* is set to [0] *Digital and control word*.

## Parameter 8-50 Coasting Select

Table 527: Parameter 8-50 Coasting Select

| 8-50 Coasting Select        |                        |                               |
|-----------------------------|------------------------|-------------------------------|
| Default value: [3] Logic OR | Parameter type: Option | Setup: All setups             |
| Conversion index: –         | Data type: Uint8       | Change during operation: True |

Select the trigger for the coasting function.

| Option | Name          | Description   |
|--------|---------------|---|
| [0]    | Digital input | A digital input triggers the coasting function.   |
| [1]    | Bus           | A serial communication port or the fieldbus triggers the coasting function.               |
| [2]    | Logic AND     | The fieldbus/serial communication port and a digital input trigger the coasting function. |
| [3]*   | Logic OR      | The fieldbus/serial communication port or a digital input triggers the coasting function. |

## Parameter 8-51 Quick Stop Select

Table 528: Parameter 8-51 Quick Stop Select

| 8-51 Quick Stop Select      |                        |                               |
|-----------------------------|------------------------|-------------------------------|
| Default value: [3] Logic OR | Parameter type: Option | Setup: All setups             |
| Conversion index: –         | Data type: Uint8       | Change during operation: True |

Select the trigger for the quick stop function.

| Option | Name          | Description   |
|--------|---------------|---|
| [0]    | Digital input | A digital input triggers the quick stop function.   |
| [1]    | Bus           | A serial communication port or the fieldbus triggers the quick stop function.               |
| [2]    | Logic AND     | The fieldbus/serial communication port and a digital input trigger the quick stop function. |
| [3]*   | Logic OR      | The fieldbus/serial communication port or a digital input triggers the quick stop function. |

## Parameter 8-52 DC Brake Select

Table 529: Parameter 8-52 DC Brake Select

| 8-52 DC Brake Select        |                        |                               |
|-----------------------------|------------------------|-------------------------------|
| Default value: Size related | Parameter type: Option | Setup: All setups             |
| Conversion index: –         | Data type: Uint8       | Change during operation: True |

Select control of the DC brake via the terminals (digital input) and/or via the fieldbus.

## N O T I C E

When *parameter 1-10 Motor Construction* is set to [1] *PM non-salient SPM*, only selection [0] *Digital input* is available.

| Option | Name          | Description   |
|--------|---------------|---|
| [0]    | Digital input | Activate a start command via a digital input.   |
| [1]    | Bus           | Activate a start command via a serial communication port or fieldbus option.                              |
| [2]    | Logic AND     | Activate a start command via the fieldbus/serial communication port and also via 1 of the digital inputs. |
| [3]    | Logic OR      | Activate a start command via the fieldbus/serial communication port or via 1 of the digital inputs.       |

## Parameter 8-53 Start Select

Table 530: Parameter 8-53 Start Select

| 8-53 Start Select           |                        |                               |
|-----------------------------|------------------------|-------------------------------|
| Default value: [3] Logic OR | Parameter type: Option | Setup: All setups             |
| Conversion index: –         | Data type: Uint8       | Change during operation: True |

Select the trigger for the start function.

| Option | Name          | Description  |
|--------|---------------|--|
| [0]    | Digital input | A digital input triggers the start function.   |
| [1]    | Bus           | A serial communication port or the fieldbus triggers the start function.               |
| [2]    | Logic AND     | The fieldbus/serial communication port and a digital input trigger the start function. |
| [3]*   | Logic OR      | The fieldbus/serial communication port or a digital input triggers the start function. |

## Parameter 8-54 Reversing Select

Table 531: Parameter 8-54 Reversing Select

| 8-54 Reversing Select       |                        |                               |
|-----------------------------|------------------------|-------------------------------|
| Default value: Size related | Parameter type: Option | Setup: All setups             |
| Conversion index: –         | Data type: Uint8       | Change during operation: True |

Select the trigger for the reversing function.

| Option | Name          | Description  |
|--------|---------------|--|
| [0]    | Digital input | A digital input triggers the reversing function.   |
| [1]    | Bus           | A serial communication port or the fieldbus triggers the reversing function.               |
| [2]    | Logic AND     | The fieldbus/serial communication port and a digital input trigger the reversing function. |
| [3]    | Logic OR      | The fieldbus/serial communication port or a digital input triggers the reversing function. |

## Parameter 8-55 Set-up Select

Table 532: Parameter 8-55 Set-up Select

| 8-55 Set-up Select          |                        |                               |
|-----------------------------|------------------------|-------------------------------|
| Default value: [3] Logic OR | Parameter type: Option | Setup: All setups             |
| Conversion index: –         | Data type: Uint8       | Change during operation: True |

Select the trigger for the setup selection.

| Option | Name          | Description   |
|--------|---------------|---|
| [0]    | Digital input | A digital input triggers the setup selection.   |
| [1]    | Bus           | A serial communication port or the fieldbus triggers the setup selection.               |
| [2]    | Logic AND     | The fieldbus/serial communication port and a digital input trigger the setup selection. |
| [3]*   | Logic OR      | The fieldbus/serial communication port or a digital input triggers the setup selection. |

## Parameter 8-56 Preset Reference Select

Table 533: Parameter 8-56 Preset Reference Select

| 8-56 Preset Reference Select |                        |                               |
|------------------------------|------------------------|-------------------------------|
| Default value: [3] Logic OR  | Parameter type: Option | Setup: All setups             |
| Conversion index: –          | Data type: Uint8       | Change during operation: True |

Select the trigger for the preset reference selection.

| Option | Name          | Description  |
|--------|---------------|--|
| [0]    | Digital input | A digital input triggers the preset reference selection.   |
| [1]    | Bus           | A serial communication port or the fieldbus triggers the preset reference selection.               |
| [2]    | Logic AND     | The fieldbus/serial communication port and a digital input trigger the preset reference selection. |
| [3]*   | Logic OR      | The fieldbus/serial communication port or a digital input triggers the preset reference selection. |

## Parameter 8-57 PROFIdrive OFF2 Select

Table 534: Parameter 8-57 PROFIdrive OFF2 Select

| 8-57 PROFIdrive OFF2 Select |                        |                               |
|-----------------------------|------------------------|-------------------------------|
| Default value: [3] Logic OR | Parameter type: Option | Setup: All setups             |
| Conversion index: –         | Data type: Uint8       | Change during operation: True |

Select control of the drive OFF2 selection via the terminals (digital input) and/or via the fieldbus. This parameter is active only when *parameter 8-01 Control Site* is set to [0] Digital and ctrl. word and *parameter 8-10 Control Word Profile* is set to [1] PROFIdrive profile.

| Option | Name          | Description |
|--------|---------------|-------------|
| [0]    | Digital input |             |
| [1]    | Bus           |             |
| [2]    | Logic AND     |             |
| [3]*   | Logic OR      |             |

## Parameter 8-58 PROFIdrive OFF3 Select

Table 535: Parameter 8-58 PROFIdrive OFF3 Select

| 8-58 PROFIdrive OFF3 Select |                        |                               |
|-----------------------------|------------------------|-------------------------------|
| Default value: [3] Logic OR | Parameter type: Option | Setup: All setups             |
| Conversion index: –         | Data type: Uint8       | Change during operation: True |

Select control of the drive OFF3 selection via the terminals (digital input) and/or via the fieldbus. This parameter is active only when *parameter 8-01 Control Site* is set to [0] Digital and ctrl. word and *parameter 8-10 Control Word Profile* is set to [1] PROFIdrive profile.

| Option | Name          | Description |
|--------|---------------|-------------|
| [0]    | Digital input |             |
| [1]    | Bus           |             |
| [2]    | Logic AND     |             |
| [3]*   | Logic OR      |             |

### 5.9.7 8-8\* FC Port Diagnostics

These parameters are used for monitoring the bus communication via the drive RS485 port terminals 68–69.

#### Parameter 8-80 Bus Message Count

Table 536: Parameter 8-80 Bus Message Count

| 8-80 Bus Message Count |                              |                               |
|------------------------|------------------------------|-------------------------------|
| Default value: 0       | Parameter type: Range, 0 - 0 | Setup: All setups             |
| Conversion index: 0    | Data type: Uint32            | Change during operation: True |

This parameter shows the number of valid telegrams detected on the bus.

#### Parameter 8-81 Bus Error Count

Table 537: Parameter 8-81 Bus Error Count

| 8-81 Bus Error Count |   |                               |
|----------------------|---|-------------------------------|
| Default value: 0     | Parameter type: Range, 0 - 0, Array [6] | Setup: All setups             |
| Conversion index: 0  | Data type: Uint32                       | Change during operation: True |

This parameter shows the number of telegrams with faults (for example, CRC fault) detected on the bus.

#### Parameter 8-82 Slave Messages Rcvd

Table 538: Parameter 8-82 Slave Messages Rcvd

| 8-82 Slave Messages Rcvd |                              |                               |
|--------------------------|------------------------------|-------------------------------|
| Default value: 0         | Parameter type: Range, 0 - 0 | Setup: All setups             |
| Conversion index: 0      | Data type: Uint32            | Change during operation: True |

This parameter shows the number of valid telegrams addressed to the slave sent by the drive.

#### Parameter 8-83 Slave Error Count

Table 539: Parameter 8-83 Slave Error Count

| 8-83 Slave Error Count |                              |                               |
|------------------------|------------------------------|-------------------------------|
| Default value: 0       | Parameter type: Range, 0 - 0 | Setup: All setups             |
| Conversion index: 0    | Data type: Uint32            | Change during operation: True |

This parameter shows the number of error telegrams which are not executed by the drive.

## 5.9.8 8-9\* Bus Jog

### Parameter 8-90 Bus Jog 1 Speed

Table 540: Parameter 8-90 Bus Jog 1 Speed

| 8-90 Bus Jog 1 Speed        |  |                               |
|-----------------------------|--|-------------------------------|
| Default value: Size related | Parameter type: Range, 0 - Par. 4-13 RPM | Setup: All setups             |
| Conversion index: 67        | Data type: Uint16                        | Change during operation: True |

Enter the jog speed. Activate this fixed jog speed via the serial port or fieldbus option.

### Parameter 8-91 Bus Jog 2 Speed

Table 541: Parameter 8-91 Bus Jog 2 Speed

| 8-91 Bus Jog 2 Speed        |  |                               |
|-----------------------------|--|-------------------------------|
| Default value: Size related | Parameter type: Range, 0 - Par. 4-13 RPM | Setup: All setups             |
| Conversion index: 67        | Data type: Uint16                        | Change during operation: True |

Enter the jog speed. Activate this fixed jog speed via the serial port or fieldbus option.

## 5.10 Parameter Group 9-\*\* PROFIBUS

### Parameter 9-00 Setpoint

Table 542: Parameter 9-00 Setpoint

| 9-00 Setpoint       |                                  |                          |
|---------------------|----------------------------------|--------------------------|
| Default value: 0    | Parameter type: Range, 0 - 65535 | Setup: All setups        |
| Conversion index: 0 | Data type: Uint16                | Change during operation: |

This parameter receives cyclic references from a master class 2. If the control priority is set to master class 2, the reference for the drive is taken from this parameter, whereas the cyclic reference is ignored.

### Parameter 9-07 Actual Value

Table 543: Parameter 9-07 Actual Value

| 9-07 Actual Value   |                                  |                          |
|---------------------|----------------------------------|--------------------------|
| Default value: 0    | Parameter type: Range, 0 - 65535 | Setup: All setups        |
| Conversion index: 0 | Data type: Uint16                | Change during operation: |

This parameter delivers the MAV for a master class 2. The parameter is valid if the control priority is set to master class 2.

### Parameter 9-15 PCD Write Configuration

Table 544: Parameter 9-15 PCD Write Configuration

| 9-15 PCD Write Configuration |                        |                               |
|------------------------------|------------------------|-------------------------------|
| Default value: Size related  | Parameter type: Option | Setup: All setups             |
| Conversion index: -          | Data type: Uint16      | Change during operation: True |

Select the parameters to be assigned to PCD 3–10 of the telegrams. The number of available PCDs depends on the telegram type. Values in PCD 3–10 are written to the selected parameters as data. For standard PROFIBUS telegrams, see *parameter 9-22 Telegram Selection*.

| Option | Name                               | Description |
|--------|------------------------------------|-------------|
| [-]    | None                               |             |
| [109]  | Mode of operation                  |             |
| [302]  | Minimum reference                  |             |
| [303]  | Maximum reference                  |             |
| [312]  | Catch up/slow down value           |             |
| [321]  | Touch target                       |             |
| [322]  | Master scale numerator             |             |
| [323]  | Master scale denominator           |             |
| [326]  | Master Offset                      |             |
| [328]  | Master offset speed ref            |             |
| [341]  | Ramp 1 ramp up time                |             |
| [342]  | Ramp 1 ramp down time              |             |
| [351]  | Ramp 2 ramp up time                |             |
| [352]  | Ramp 2 ramp down time              |             |
| [361]  | Ramp 3 ramp up time                |             |
| [362]  | Ramp 3 ramp down time              |             |
| [380]  | Jog/homing ramp time jog ramp time |             |
| [381]  | Quick stop ramp time               |             |
| [411]  | Motor speed low limit [RPM]        |             |
| [412]  | Motor speed low limit [Hz]         |             |
| [413]  | Motor speed high limit [RPM]       |             |
| [414]  | Motor speed high limit [Hz]        |             |
| [416]  | Torque limit motor mode            |             |
| [417]  | Torque limit generator mode        |             |
| [482]  | Power limit motor mode             |             |
| [483]  | Power limit generator mode         |             |
| [491]  | Positive speed limit [RPM]         |             |
| [492]  | Positive speed limit [Hz]          |             |
| [493]  | Negative speed limit [RPM]         |             |
| [494]  | Negative speed limit [Hz]          |             |
| [495]  | Positive torque limit              |             |
| [496]  | Negative torque limit              |             |



| Option | Name                               | Description |
|--------|------------------------------------|-------------|
| [553]  | Term. 29 high ref./feedb. value    |             |
| [558]  | Term. 33 high ref./feedb. value    |             |
| [590]  | Digital & relay bus control        |             |
| [593]  | Pulse out #27 bus control          |             |
| [595]  | Pulse out #29 bus control          |             |
| [597]  | Pulse out #30/6 bus control        |             |
| [615]  | Terminal 53 high ref./feedb. value |             |
| [625]  | Terminal 54 high ref./feedb. value |             |
| [653]  | Term 42 output bus ctrl            |             |
| [663]  | Terminal X30/8 bus control         |             |
| [673]  | Terminal X45/1 bus control         |             |
| [683]  | Terminal X45/3 bus control         |             |
| [702]  | Speed PID proportional gain        |             |
| [703]  | Speed PID integral time            |             |
| [708]  | Speed PID feed forward factor      |             |
| [748]  | PCD feed forward                   |             |
| [890]  | Bus jog 1 speed                    |             |
| [891]  | Bus jog 2 speed                    |             |
| [1680] | Fieldbus CTW 1                     |             |
| [1681] | Fieldbus sync. REF                 |             |
| [1682] | Fieldbus REF 1                     |             |
| [1683] | Fieldbus pos. REF                  |             |
| [1685] | FC port CTW 1                      |             |
| [1686] | FC port REF 1                      |             |
| [1688] | Fieldbus torque FF.                |             |
| [1740] | Fieldbus sync. delta               |             |
| [1741] | Fieldbus profile velocity          |             |
| [1742] | Fieldbus velocity FF.              |             |
| [1743] | Fieldbus acceleration FF.          |             |
| [1744] | Fieldbus target velocity           |             |
| [1782] | Home position                      |             |
| [1783] | Homing speed                       |             |

| Option | Name                        | Description |
|--------|-----------------------------|-------------|
| [1788] | Master home position        |             |
| [3310] | Sync factor master          |             |
| [3311] | Sync factor slave           |             |
| [3401] | PCD 1 write to MCO          |             |
| [3402] | PCD 2 write to MCO          |             |
| [3403] | PCD 3 write to MCO          |             |
| [3404] | PCD 4 write to MCO          |             |
| [3405] | PCD 5 write to MCO          |             |
| [3406] | PCD 6 write to MCO          |             |
| [3407] | PCD 7 write to MCO          |             |
| [3408] | PCD 8 write to MCO          |             |
| [3409] | PCD 9 write to MCO          |             |
| [3410] | PCD 10 write to MCO         |             |
| [3644] | Terminal X49/7 bus control  |             |
| [3654] | Terminal X49/9 bus control  |             |
| [3664] | Terminal X49/11 bus control |             |
| [4520] | Type                        |             |

## Parameter 9-16 PCD Read Configuration

Table 545: Parameter 9-16 PCD Read Configuration

| 9-16 PCD Read Configuration |                                   |                               |
|-----------------------------|-----------------------------------|-------------------------------|
| Default value: Size related | Parameter type: Option, Array 156 | Setup: All setups             |
| Conversion index: –         | Data type: Uint16                 | Change during operation: True |

Select the parameters to be assigned to PCD 3–10 of the telegrams. The number of available PCDs depends on the telegram type. Values in PCD 3–10 are written to the selected parameters as data. For standard PROFIBUS telegrams, see *parameter 9-22 Telegram Selection*.

| Option | Name                  | Description |
|--------|-----------------------|-------------|
| [-]    | None                  |             |
| [15]   | Readout: actual setup |             |
| [1397] | Alert alarm word      |             |
| [1398] | Alert warning word    |             |
| [1399] | Alert status word     |             |
| [1472] | Legacy alarm word     |             |
| [1473] | Legacy warning word   |             |

| Option | Name                          | Description |
|--------|-------------------------------|-------------|
| [1474] | Leg. ext. status word         |             |
| [1500] | Operating hours               |             |
| [1501] | Running hours                 |             |
| [1502] | kWh counter                   |             |
| [1600] | Control word                  |             |
| [1601] | Reference [unit]              |             |
| [1602] | Reference %                   |             |
| [1603] | Status word                   |             |
| [1605] | Main actual value [%]         |             |
| [1606] | Actual position               |             |
| [1607] | Target position               |             |
| [1608] | Position error                |             |
| [1609] | Custom readout                |             |
| [1610] | Power [kW]                    |             |
| [1611] | Power [hp]                    |             |
| [1612] | Motor voltage                 |             |
| [1613] | Frequency                     |             |
| [1614] | Motor current                 |             |
| [1615] | Frequency [%]                 |             |
| [1616] | Torque [Nm]                   |             |
| [1617] | Speed [RPM]                   |             |
| [1618] | Motor thermal                 |             |
| [1619] | Thermistor sensor temperature |             |
| [1620] | Motor angle                   |             |
| [1621] | Torque [%] high res.          |             |
| [1622] | Torque [%]                    |             |
| [1623] | Motor shaft power [kW]        |             |
| [1624] | Calibrated stator resistance  |             |
| [1625] | Torque [Nm] high              |             |
| [1628] | Angle error                   |             |
| [1630] | DC link voltage               |             |
| [1632] | Brake energy /s               |             |

| Option | Name                        | Description |
|--------|-----------------------------|-------------|
| [1633] | Brake energy average        |             |
| [1634] | Heatsink temp.              |             |
| [1635] | Inverter thermal            |             |
| [1638] | SL controller state         |             |
| [1639] | Control card temp.          |             |
| [1642] | Service log counter         |             |
| [1644] | Speed error [RPM]           |             |
| [1645] | Motor phase U current       |             |
| [1646] | Motor phase V current       |             |
| [1647] | Motor phase W current       |             |
| [1648] | Speed ref. after ramp [RPM] |             |
| [1650] | External reference          |             |
| [1651] | Pulse reference             |             |
| [1652] | Feedback[Unit]              |             |
| [1653] | Digi pot reference          |             |
| [1657] | Feedback [RPM]              |             |
| [1660] | Digital input               |             |
| [1661] | Terminal 53 switch setting  |             |
| [1662] | Analog input 53             |             |
| [1663] | Terminal 54 switch setting  |             |
| [1664] | Analog input 54             |             |
| [1665] | Analog output 42 [mA]       |             |
| [1666] | Digital output [bin]        |             |
| [1667] | Freq. input #29 [Hz]        |             |
| [1668] | Freq. input #33 [Hz]        |             |
| [1669] | Pulse output #27 [Hz]       |             |
| [1670] | Pulse output #29 [Hz]       |             |
| [1671] | Relay output [bin]          |             |
| [1672] | Counter A                   |             |
| [1673] | Counter B                   |             |
| [1674] | Prec. stop counter          |             |
| [1675] | Analog in X30/11            |             |

| Option | Name                            | Description |
|--------|---------------------------------|-------------|
| [1676] | Analog in X30/12                |             |
| [1677] | Analog out X30/8 [mA]           |             |
| [1678] | Analog out X45/1 [mA]           |             |
| [1679] | Analog out X45/3 [mA]           |             |
| [1684] | Comm. option STW                |             |
| [1687] | Bus readout alarm/warning       |             |
| [1689] | Configurable alarm/warning word |             |
| [1690] | Alarm word                      |             |
| [1691] | Alarm word 2                    |             |
| [1692] | Warning word                    |             |
| [1693] | Warning word 2                  |             |
| [1694] | Ext. status word                |             |
| [1695] | Ext. status word 2              |             |
| [1696] | Maintenance word                |             |
| [1697] | Alarm word 3                    |             |
| [1698] | Warning word 3                  |             |
| [1804] | Mech brake count                |             |
| [1820] | Commanded position              |             |
| [1821] | Master position                 |             |
| [1823] | Virtual master pos.             |             |
| [1824] | Marker pos. offset              |             |
| [1825] | Latched actual pos.             |             |
| [1826] | Actual velocity [pu/s]          |             |
| [1827] | Safe opt. est. speed            |             |
| [1828] | Safe opt. meas. speed           |             |
| [1829] | Safe opt. speed error           |             |
| [1836] | Analog input X48/2 [mA]         |             |
| [1837] | Temp. input X48/4               |             |
| [1838] | Temp. input X48/7               |             |
| [1839] | Temp. input X48/10              |             |
| [1840] | Analog input X49/1              |             |
| [1841] | Analog input X49/3              |             |

| Option | Name                      | Description |
|--------|---------------------------|-------------|
| [1842] | Analog input X49/5        |             |
| [1843] | Analog input X49/7        |             |
| [1844] | Analog out X49/9          |             |
| [1845] | Analog out X49/11         |             |
| [1846] | X49 digital output [bin]  |             |
| [1860] | Digital input 2           |             |
| [1889] | Mode of operation display |             |
| [1899] | Speed PID torque FF. [Nm] |             |
| [3421] | PCD 1 read from MCO       |             |
| [3422] | PCD 2 read from MCO       |             |
| [3423] | PCD 3 read from MCO       |             |
| [3424] | PCD 4 read from MCO       |             |
| [3425] | PCD 5 read from MCO       |             |
| [3426] | PCD 6 read from MCO       |             |
| [3427] | PCD 7 read from MCO       |             |
| [3428] | PCD 8 read from MCO       |             |
| [3429] | PCD 9 read from MCO       |             |
| [3430] | PCD 10 read from MCO      |             |
| [3440] | Digital inputs            |             |
| [3441] | Digital outputs           |             |
| [3450] | Actual position           |             |
| [3451] | Commanded position        |             |
| [3452] | Actual master position    |             |
| [3453] | Slave index position      |             |
| [3454] | Master index position     |             |
| [3455] | Curve position            |             |
| [3456] | Track error               |             |
| [3457] | Synchronizing error       |             |
| [3458] | Actual velocity           |             |
| [3459] | Actual master velocity    |             |
| [3460] | Synchronizing status      |             |
| [3461] | Axis status               |             |

| Option | Name                         | Description |
|--------|------------------------------|-------------|
| [3462] | Program status               |             |
| [3464] | MCO 302 status               |             |
| [3465] | MCO 302 control              |             |
| [3466] | SPI error counter            |             |
| [3470] | MCO alarm word 1             |             |
| [3471] | MCO alarm word 2             |             |
| [4029] | B-EMF protection log readout |             |
| [4280] | Safe option status           |             |
| [4285] | Active safe func.            |             |
| [4521] | Status                       |             |
| [4523] | Baseline failure             |             |
| [4590] | Stator [%]                   |             |
| [4591] | Load [%]                     |             |
| [4592] | Sensor 1 [%]                 |             |
| [4593] | Sensor 1 [unit]              |             |
| [4594] | Sensor 2 [%]                 |             |
| [4595] | Sensor 2 [unit]              |             |
| [4596] | Sensor 3 [%]                 |             |
| [4597] | Sensor 3 [unit]              |             |
| [4598] | Sensor 4 [%]                 |             |
| [4599] | Sensor 4 [unit]              |             |

### Parameter 9-18 Node Address

Table 546: Parameter 9-18 Node Address

| 9-18 Node Address   |   |                               |
|---------------------|---|-------------------------------|
| Default value: 126  | Parameter type: Range, 1 - size related | Setup: 1 setup                |
| Conversion index: 0 | Data type: Uint8                        | Change during operation: True |

Enter the station address in this parameter or, alternatively, in the hardware switch. To adjust the station address in this parameter, set the hardware switch to 126 or 127 (that is all switches set to ON). Otherwise, this parameter shows the actual setting of the switch.

### Parameter 9-19 Drive Unit System Number

Table 547: Parameter 9-19 Drive Unit System Number

| 9-19 Drive Unit System Number |                                  |                               |
|-------------------------------|----------------------------------|-------------------------------|
| Default value: 1034           | Parameter type: Range, 0 - 65535 | Setup: All setups             |
| Conversion index: 0           | Data type: Uint16                | Change during operation: True |

Manufacturer-specific system ID.  
Parameter 9-22 Telegram Selection

Table 548: Parameter 9-22 Telegram Selection

| 9-22 Telegram Selection   |                        |                               |
|---------------------------|------------------------|-------------------------------|
| Default value: [100] None | Parameter type: Option | Setup: 1 setup                |
| Conversion index: –       | Data type: Uint8       | Change during operation: True |

Select a standard PROFIBUS telegram configuration for the drive as an alternative to the freely configurable telegrams in *parameter 9-15 PCD Write Configuration* and *parameter 9-16 PCD Read Configuration*.

| Option | Name                | Description |
|--------|---------------------|-------------|
| [1]    | Standard telegram 1 |             |
| [100]* | None                |             |
| [101]  | PPO 1               |             |
| [102]  | PPO 2               |             |
| [103]  | PPO 3               |             |
| [104]  | PPO 4               |             |
| [105]  | PPO 5               |             |
| [106]  | PPO 6               |             |
| [107]  | PPO 7               |             |
| [108]  | PPO 8               |             |
| [200]  | Custom telegram 1   |             |
| [202]  | Custom telegram 3   |             |

Parameter 9-23 Parameters for Signals

Table 549: Parameter 9-23 Parameters for Signals

| 9-23 Parameters for Signals |                        |                               |
|-----------------------------|------------------------|-------------------------------|
| Default value: [0] None     | Parameter type: Option | Setup: All setups             |
| Conversion index: –         | Data type: Uint16      | Change during operation: True |

This parameter contains a list of signals available for selection in *parameter 9-15 PCD Write Configuration* and *parameter 9-16 PCD Read Configuration*.

| Option | Name                     | Description |
|--------|--------------------------|-------------|
| [0]*   | None                     |             |
| [109]  | Mode of operation        |             |
| [302]  | Minimum reference        |             |
| [303]  | Maximum reference        |             |
| [312]  | Catch up/slow down value |             |
| [321]  | Touch target             |             |



| Option | Name                               | Description |
|--------|------------------------------------|-------------|
| [322]  | Master scale numerator             |             |
| [323]  | Master scale denominator           |             |
| [326]  | Master Offset                      |             |
| [328]  | Master offset speed ref            |             |
| [341]  | Ramp 1 ramp up time                |             |
| [342]  | Ramp 1 ramp down time              |             |
| [351]  | Ramp 2 ramp up time                |             |
| [352]  | Ramp 2 ramp down time              |             |
| [361]  | Ramp 3 ramp up time                |             |
| [362]  | Ramp 3 ramp down time              |             |
| [380]  | Jog/homing ramp time jog ramp time |             |
| [381]  | Quick stop ramp time               |             |
| [411]  | Motor speed low limit [RPM]        |             |
| [412]  | Motor speed low limit [Hz]         |             |
| [413]  | Motor speed high limit [RPM]       |             |
| [414]  | Motor speed high limit [Hz]        |             |
| [416]  | Torque limit motor mode            |             |
| [417]  | Torque limit generator mode        |             |
| [482]  | Power limit motor mode             |             |
| [483]  | Power limit generator mode         |             |
| [491]  | Positive speed limit [RPM]         |             |
| [492]  | Positive speed limit [Hz]          |             |
| [493]  | Negative speed limit [RPM]         |             |
| [494]  | Negative speed limit [Hz]          |             |
| [495]  | Positive torque limit              |             |
| [496]  | Negative torque limit              |             |
| [553]  | Term. 29 high ref./feedb. value    |             |
| [558]  | Term. 33 high ref./feedb. value    |             |
| [590]  | Digital & relay bus control        |             |
| [593]  | Pulse out #27 bus control          |             |
| [595]  | Pulse out #29 bus control          |             |
| [597]  | Pulse out #30/6 bus control        |             |

| Option | Name                               | Description |
|--------|------------------------------------|-------------|
| [615]  | Terminal 53 high ref./feedb. value |             |
| [625]  | Terminal 54 high ref./feedb. value |             |
| [653]  | Term 42 output bus ctrl            |             |
| [663]  | Terminal X30/8 bus control         |             |
| [673]  | Terminal X45/1 bus control         |             |
| [683]  | Terminal X45/3 bus control         |             |
| [702]  | Speed PID proportional gain        |             |
| [703]  | Speed PID integral time            |             |
| [708]  | Speed PID feed forward factor      |             |
| [748]  | PCD feed forward                   |             |
| [890]  | Bus jog 1 speed                    |             |
| [891]  | Bus jog 2 speed                    |             |
| [1397] | Alert alarm word                   |             |
| [1398] | Alert warning word                 |             |
| [1399] | Alert status word                  |             |
| [1472] | Legacy alarm word                  |             |
| [1473] | Legacy warning word                |             |
| [1474] | Leg. ext. status word              |             |
| [1500] | Operating hours                    |             |
| [1501] | Running hours                      |             |
| [1502] | kWh counter                        |             |
| [1600] | Control word                       |             |
| [1601] | Reference [unit]                   |             |
| [1602] | Reference %                        |             |
| [1603] | Status word                        |             |
| [1605] | Main actual value [%]              |             |
| [1606] | Actual position                    |             |
| [1607] | Target position                    |             |
| [1608] | Position error                     |             |
| [1609] | Custom readout                     |             |
| [1610] | Power [kW]                         |             |
| [1611] | Power [hp]                         |             |

| Option | Name                          | Description |
|--------|-------------------------------|-------------|
| [1612] | Motor voltage                 |             |
| [1613] | Frequency                     |             |
| [1614] | Motor current                 |             |
| [1615] | Frequency [%]                 |             |
| [1616] | Torque [Nm]                   |             |
| [1617] | Speed [RPM]                   |             |
| [1618] | Motor thermal                 |             |
| [1619] | Thermistor sensor temperature |             |
| [1620] | Motor angle                   |             |
| [1621] | Torque [%] high res.          |             |
| [1622] | Torque [%]                    |             |
| [1623] | Motor shaft power [kW]        |             |
| [1624] | Calibrated stator resistance  |             |
| [1625] | Torque [Nm] high              |             |
| [1628] | Angle error                   |             |
| [1630] | DC link voltage               |             |
| [1632] | Brake energy /s               |             |
| [1633] | Brake energy average          |             |
| [1634] | Heatsink temp.                |             |
| [1635] | Inverter thermal              |             |
| [1638] | SL controller state           |             |
| [1639] | Control card temp.            |             |
| [1642] | Service log counter           |             |
| [1644] | Speed error [RPM]             |             |
| [1645] | Motor phase U current         |             |
| [1646] | Motor phase V current         |             |
| [1647] | Motor phase W current         |             |
| [1648] | Speed ref. after ramp [RPM]   |             |
| [1650] | External reference            |             |
| [1651] | Pulse reference               |             |
| [1652] | Feedback[unit]                |             |
| [1653] | Digi pot reference            |             |

| Option | Name                            | Description |
|--------|---------------------------------|-------------|
| [1657] | Feedback [RPM]                  |             |
| [1660] | Digital input                   |             |
| [1661] | Terminal 53 switch setting      |             |
| [1662] | Analog input 53                 |             |
| [1663] | Terminal 54 switch setting      |             |
| [1664] | Analog input 54                 |             |
| [1665] | Analog output 42 [mA]           |             |
| [1666] | Digital output [bin]            |             |
| [1667] | Freq. input #29 [Hz]            |             |
| [1668] | Freq. input #33 [Hz]            |             |
| [1669] | Pulse output #27 [Hz]           |             |
| [1670] | Pulse output #29 [Hz]           |             |
| [1671] | Relay output [bin]              |             |
| [1672] | Counter A                       |             |
| [1673] | Counter B                       |             |
| [1674] | Prec. stop counter              |             |
| [1675] | Analog in X30/11                |             |
| [1676] | Analog in X30/12                |             |
| [1677] | Analog out X30/8 [mA]           |             |
| [1678] | Analog out X45/1 [mA]           |             |
| [1679] | Analog out X45/3 [mA]           |             |
| [1680] | Fieldbus CTW 1                  |             |
| [1681] | Fieldbus sync. REF              |             |
| [1682] | Fieldbus REF 1                  |             |
| [1683] | Fieldbus pos. REF               |             |
| [1684] | Comm. option STW                |             |
| [1685] | FC port CTW 1                   |             |
| [1686] | FC port REF 1                   |             |
| [1687] | Bus readout alarm/warning       |             |
| [1688] | Fieldbus torque FF.             |             |
| [1689] | Configurable alarm/warning word |             |
| [1690] | Alarm word                      |             |

| Option | Name                      | Description |
|--------|---------------------------|-------------|
| [1691] | Alarm word 2              |             |
| [1692] | Alarm word                |             |
| [1693] | Alarm word 2              |             |
| [1694] | Ext. status word          |             |
| [1695] | Ext. status word 2        |             |
| [1696] | Maintenance word          |             |
| [1697] | Alarm word 3              |             |
| [1698] | Warning word 3            |             |
| [1740] | Fieldbus sync. delta      |             |
| [1741] | Fieldbus profile velocity |             |
| [1742] | Fieldbus velocity FF.     |             |
| [1743] | Fieldbus acceleration FF. |             |
| [1744] | Fieldbus target velocity  |             |
| [1782] | Home position             |             |
| [1783] | Homing speed              |             |
| [1788] | Master home position      |             |
| [1804] | Mech brake count          |             |
| [1820] | Commanded position        |             |
| [1821] | Master position           |             |
| [1823] | Virtual master pos.       |             |
| [1824] | Master pos. offset        |             |
| [1825] | Latched actual pos.       |             |
| [1826] | Actual velocity [pu/s]    |             |
| [1827] | Safe opt. est. speed      |             |
| [1828] | Safe opt. meas. speed     |             |
| [1829] | Safe opt. speed error     |             |
| [1836] | Analog input X48/2[mA]    |             |
| [1837] | Temp. input X48/4         |             |
| [1838] | Temp. input X48/7         |             |
| [1839] | Temp. input X48/10        |             |
| [1840] | Analog input X49/1        |             |
| [1841] | Analog input X49/3        |             |

| Option | Name                      | Description |
|--------|---------------------------|-------------|
| [1842] | Analog input X49/5        |             |
| [1843] | Analog out X49/7          |             |
| [1844] | Analog out X49/9          |             |
| [1845] | Analog out X49/11         |             |
| [1846] | X49 Digital output [bin]  |             |
| [1860] | Digital input 2           |             |
| [1889] | Mode of operation display |             |
| [1899] | Speed PID torque FF. [Nm] |             |
| [3310] | Sync factor master        |             |
| [3311] | Sync factor slave         |             |
| [3401] | PCD 1 write to MCO        |             |
| [3402] | PCD 2 write to MCO        |             |
| [3403] | PCD 3 write to MCO        |             |
| [3404] | PCD 4 write to MCO        |             |
| [3405] | PCD 5 write to MCO        |             |
| [3406] | PCD 6 write to MCO        |             |
| [3407] | PCD 7 write to MCO        |             |
| [3408] | PCD 8 write to MCO        |             |
| [3409] | PCD 9 write to MCO        |             |
| [3410] | PCD 10 write to MCO       |             |
| [3421] | PCD 1 read from MCO       |             |
| [3422] | PCD 2 read from MCO       |             |
| [3423] | PCD 3 read from MCO       |             |
| [3424] | PCD 4 read from MCO       |             |
| [3425] | PCD 5 read from MCO       |             |
| [3426] | PCD 6 read from MCO       |             |
| [3427] | PCD 7 read from MCO       |             |
| [3428] | PCD 8 read from MCO       |             |
| [3429] | PCD 9 read from MCO       |             |
| [3430] | PCD 10 read from MCO      |             |
| [3440] | Digital inputs            |             |
| [3441] | Digital outputs           |             |

| Option | Name                         | Description |
|--------|------------------------------|-------------|
| [3450] | Actual position              |             |
| [3451] | Commanded position           |             |
| [3452] | Actual master position       |             |
| [3453] | Slave index position         |             |
| [3454] | Master index position        |             |
| [3455] | Curve position               |             |
| [3456] | Track error                  |             |
| [3457] | Synchronizing error          |             |
| [3458] | Actual velocity              |             |
| [3459] | Actual master velocity       |             |
| [3460] | Synchronizing status         |             |
| [3461] | Axis status                  |             |
| [3462] | Program status               |             |
| [3464] | MCO 302 status               |             |
| [3465] | MCO 303 control              |             |
| [3466] | SPI error counter            |             |
| [3470] | MCO alarm word 1             |             |
| [3471] | MCO alarm word 2             |             |
| [3644] | Terminal X49/7 bus control   |             |
| [3654] | Terminal X49/9 bus control   |             |
| [3664] | Terminal X49/11 bus control  |             |
| [4029] | B-EMF protection log readout |             |
| [4280] | Safe option status           |             |
| [4285] | Active safe func.            |             |
| [4520] | Type                         |             |
| [4521] | Status                       |             |
| [4523] | Baseline failure             |             |
| [4590] | Stator [%]                   |             |
| [4591] | Load [%]                     |             |
| [4592] | Sensor 1 [%]                 |             |
| [4593] | Sensor 1 [unit]              |             |
| [4594] | Sensor 2 [%]                 |             |

| Option | Name            | Description |
|--------|-----------------|-------------|
| [4595] | Sensor 3 [unit] |             |
| [4596] | Sensor 3 [%]    |             |
| [4597] | Sensor 3 [unit] |             |
| [4598] | Sensor 4 [%]    |             |
| [4599] | Sensor 4 [unit] |             |

## Parameter 9-27 Parameter Edit

Table 550: Parameter 9-27 Parameter Edit

| 9-27 Parameter Edit        |                        |                                |
|----------------------------|------------------------|--------------------------------|
| Default value: [1] Enabled | Parameter type: Option | Setup: 2 setups                |
| Conversion index: –        | Data type: Uint16      | Change during operation: False |

Parameters can be edited via:

- PROFIBUS
- The standard RS485 interface
- The LCP

| Option | Name     | Description |
|--------|----------|-------------|
| [0]    | Disabled |             |
| [1]*   | Enabled  |             |

## Parameter 9-28 Process Control

Table 551: Parameter 9-28 Process Control

| 9-28 Process Control                    |                        |                                |
|---|------------------------|--------------------------------|
| Default value: [1] Enable cyclic master | Parameter type: Option | Setup: 2 setups                |
| Conversion index: –                     | Data type: Uint8       | Change during operation: False |

Process control (setting of control word, speed reference, and process data) is possible via either PROFIBUS or standard fieldbus, but not both simultaneously. Local control is always possible via the LCP. Control via process control is possible via either terminals or fieldbus depending on the settings in *parameter 8-50 Coasting Select* to *parameter 8-56 Preset Reference Select*.

| Option | Name                 | Description |
|--------|----------------------|-------------|
| [0]    | Disable              |             |
| [1]*   | Enable cyclic master |             |

## Parameter 9-44 Fault Message Counter

Table 552: Parameter 9-44 Fault Message Counter

| 9-44 Fault Message Counter |                                  |                          |
|----------------------------|----------------------------------|--------------------------|
| Default value: 0           | Parameter type: Range, 0 - 65535 | Setup: All setups        |
| Conversion index: 0        | Data type: Uint16                | Change during operation: |



Indicates the number of fault events presently stored in *parameter 9-45 Fault Code*. The buffer capacity is maximum 8 error events. The buffer and counter are set to 0 by reset or power-up.

Parameter 9-45 Fault Code

Table 553: Parameter 9-45 Fault Code

| 9-45 Fault Code     |                            |                          |
|---------------------|----------------------------|--------------------------|
| Default value: 0    | Parameter type: Range, N/A | Setup: All setups        |
| Conversion index: 0 | Data type: Uint16          | Change during operation: |

This buffer contains the alarm word for all alarms and warnings that have occurred since the last reset or power-up. The buffer capacity is maximum 8 error events.

Parameter 9-47 Fault Number

Table 554: Parameter 9-47 Fault Number

| 9-47 Fault Number   |                            |                          |
|---------------------|----------------------------|--------------------------|
| Default value: 0    | Parameter type: Range, N/A | Setup: All setups        |
| Conversion index: 0 | Data type: Uint16          | Change during operation: |

This buffer contains the alarm word for all alarms and warnings that have occurred since the last reset or power-up. The buffer capacity is maximum 8 error events.

Parameter 9-52 Fault Situation Counter

Table 555: Parameter 9-52 Fault Situation Counter

| 9-52 Fault Situation Counter |                                 |                          |
|------------------------------|---------------------------------|--------------------------|
| Default value: 0             | Parameter type: Range, 0 - 1000 | Setup: All setups        |
| Conversion index: 0          | Data type: Uint16               | Change during operation: |

Indicates the number of fault events that have occurred since the last reset or power-up.

Table 556: Parameter 9-53 PROFIBUS Warning Word

| 9-53 PROFIBUS Warning Word |                                  |                               |
|----------------------------|----------------------------------|-------------------------------|
| Default value: 0           | Parameter type: Range, 0 - 65535 | Setup: All setups             |
| Conversion index: 0        | Data type: V2                    | Change during operation: True |

This parameter shows PROFIBUS communication warnings.

Table 557: PROFIBUS Warning Word

| Bit | Description                               |
|-----|---|
| 0   | Connection with DP-master is not OK.      |
| 1   | Not used.                                 |
| 2   | FDL (fieldbus data link layer) is not OK. |
| 3   | Clear data command received.              |
| 4   | Actual value is not updated.              |
| 5   | Baud rate search.                         |
| 6   | PROFIBUS ASIC is not transmitting.        |
| 7   | Initializing of PROFIBUS is not OK.       |

| Bit | Description                           |
|-----|---------------------------------------|
| 8   | Drive is tripped.                     |
| 9   | Internal CAN error.                   |
| 10  | Wrong configuration data from PLC.    |
| 11  | Wrong ID sent by PLC.                 |
| 12  | Internal fault occurred.              |
| 13  | Not configured.                       |
| 14  | Timeout active.                       |
| 15  | Warning 34, Fieldbus Fault is active. |

Parameter 9-63 Actual Baud Rate

Table 558: Parameter 9-63 Actual Baud Rate

| 9-63 Actual Baud Rate                   |                        |                               |
|---|------------------------|-------------------------------|
| Default value: [255] No baud rate found | Parameter type: Option | Setup: All setups             |
| Conversion index: –                     | Data type: Uint8       | Change during operation: True |

This parameter shows the actual PROFIBUS baud rate. The PROFIBUS master automatically sets the baud rate.

| Option | Name               | Description |
|--------|--------------------|-------------|
| [0]    | 9,6 kbit/s         |             |
| [1]    | 19,2 kbit/s        |             |
| [2]    | 93,75 kbit/s       |             |
| [3]    | 187,5 kbit/s       |             |
| [4]    | 500 kbit/s         |             |
| [6]    | 1500 kbit/s        |             |
| [7]    | 3000 kbit/s        |             |
| [8]    | 6000 kbit/s        |             |
| [9]    | 12000 kbit/s       |             |
| [10]   | 31,25 kbit/s       |             |
| [11]   | 45,45 kbit/s       |             |
| [255]* | No baud rate found |             |

Table 559: Parameter 9-64 Device Identification

| 9-64 Device Identification |                              |                          |
|----------------------------|------------------------------|--------------------------|
| Default value: 0           | Parameter type: Range, 0 - 0 | Setup: All setups        |
| Conversion index: 0        | Data type: Uint16            | Change during operation: |

**N O T I C E**

This parameter is not visible via LCP.

The device identification parameter. The data type is array [n] of unsigned16. The assignment of the 1<sup>st</sup> subindexes is defined and shown in the following table.

| Index | Content                           | Value             |
|-------|-----------------------------------|-------------------|
| [0]   | Manufacturer                      | 128 (for Danfoss) |
| [1]   | Device type                       | 1                 |
| [2]   | Version                           | xxyy              |
| [3]   | Firmware date year                | yyyy              |
| [4]   | Firmware date month               | ddmm              |
| [5]   | No. of axes                       | Variable          |
| [6]   | Vendor specific: PB version       | xxyy              |
| [7]   | Vendor specific: Database version | xxyy              |
| [8]   | Vendor specific: AOC version      | xxyy              |
| [9]   | Vendor specific: MOC version      | xxyy              |

Parameter 9-65 Profile Number

Table 560: Parameter 9-65 Profile Number

| 9-65 Profile Number |                              |                          |
|---------------------|------------------------------|--------------------------|
| Default value: 0    | Parameter type: Range, 0 - 0 | Setup: All setups        |
| Conversion index: 0 | Data type: OctetString       | Change during operation: |

**N O T I C E**

This parameter is not visible via LCP.

This parameter contains the profile identification. Byte 1 contains the profile number. Byte 2 contains the number of the profile.

Table 561: Parameter 9-67 Control Word 1

| 9-67 Control Word 1 |                                  |                          |
|---------------------|----------------------------------|--------------------------|
| Default value: 0    | Parameter type: Range, 0 - 65535 | Setup: All setups        |
| Conversion index: 0 | Data type: V2                    | Change during operation: |

This parameter accepts the control word from a master class 2 in the same format as PCD 1.

Parameter 9-68 Status Word 1

Table 562: Parameter 9-68 Status Word 1

| 9-68 Status Word 1  |                                  |                          |
|---------------------|----------------------------------|--------------------------|
| Default value: 0    | Parameter type: Range, 0 - 65535 | Setup: All setups        |
| Conversion index: 0 | Data type: V2                    | Change during operation: |

This parameter delivers the status word for a master class 2 in the same format as PCD 2.

Table 563: Parameter 9-70 Edit Set-up

| 9-70 Edit Set-up            |                        |                               |
|-----------------------------|------------------------|-------------------------------|
| Default value: [1] Set-up 1 | Parameter type: Option | Setup: All setups             |
| Conversion index: –         | Data type: Uint8       | Change during operation: True |

Select the setup in which programming (change of data) is performed during operation. It is possible to program the 2 setups independently of the setup selected as the active setup. Parameter access from each master is directed to the setup selected by the individual master (cyclic, acyclic MCL1, 1<sup>st</sup> acyclic MCL2, 2<sup>nd</sup> acyclic MCL2, 3<sup>rd</sup> acyclic MCL2).

| Option | Name          | Description |
|--------|---------------|-------------|
| [0]    | Factory setup |             |
| [1]*   | Set-up 1      |             |
| [2]    | Set-up 2      |             |
| [3]    | Set-up 3      |             |
| [4]    | Set-up 4      |             |
| [9]    | Active set-up |             |

## Parameter 9-71 PROFIBUS Save Data Values

Table 564: Parameter 9-71 PROFIBUS Save Data Values

| 9-71 PROFIBUS Save Data Values |                        |                               |
|--------------------------------|------------------------|-------------------------------|
| Default value: [0] Off         | Parameter type: Option | Setup: All setups             |
| Conversion index: –            | Data type: Uint8       | Change during operation: True |

Parameter values changed via RS485 are not automatically stored in a non-volatile memory. Use this parameter to activate a function that stores parameter values in the EEPROM non-volatile memory, so changed parameter values are retained at power-down.

| Option | Name             | Description |
|--------|------------------|-------------|
| [0]*   | Off              |             |
| [1]    | Store all setups |             |
| [2]    | Store all setups |             |

## Parameter 9-72 PROFIBUSDriveReset

Table 565: Parameter 9-72 PROFIBUSDriveReset

| 9-72 PROFIBUSDriveReset      |                        |                                |
|------------------------------|------------------------|--------------------------------|
| Default value: [0] No action | Parameter type: Option | Setup: 1 setup                 |
| Conversion index: –          | Data type: Uint8       | Change during operation: False |

## N O T I C E

Resets the VLT® PROFIBUS DP-V1 MCA 101 option only.

| Option | Name                | Description |
|--------|---------------------|-------------|
| [0]*   | No action           |             |
| [1]    | Power-on reset      |             |
| [2]    | Power-on reset prep |             |
| [3]    | Comm option reset   |             |

Parameter 9-75 DO Identification

Table 566: Parameter 9-75 DO Identification

| 9-75 DO Identification |                                  |                          |
|------------------------|----------------------------------|--------------------------|
| Default value: 0       | Parameter type: Range, 0 - 65535 | Setup: All setups        |
| Conversion index: 0    | Data type: Uint16                | Change during operation: |

Provides information about the DO (direct object). This parameter is for PROFINET only.

Parameter 9-80 Defined Parameters (1)

Table 567: Parameter 9-80 Defined Parameters (1)

| 9-80 Defined Parameters (1) |                                 |                                |
|-----------------------------|---------------------------------|--------------------------------|
| Default value: 0            | Parameter type: Range, 0 - 9999 | Setup: All setups              |
| Conversion index: 0         | Data type: Uint16               | Change during operation: False |

This parameter shows a list of all the defined drive parameters available for PROFIBUS.

Parameter 9-81 Defined Parameters (2)

Table 568: Parameter 9-81 Defined Parameters (2)

| 9-81 Defined Parameters (2) |                                 |                                |
|-----------------------------|---------------------------------|--------------------------------|
| Default value: 0            | Parameter type: Range, 0 - 9999 | Setup: All setups              |
| Conversion index: 0         | Data type: Uint16               | Change during operation: False |

This parameter shows a list of all the defined drive parameters available for PROFIBUS.

Parameter 9-82 Defined Parameters (3)

Table 569: Parameter 9-82 Defined Parameters (3)

| 9-82 Defined Parameters (3) |                                 |                                |
|-----------------------------|---------------------------------|--------------------------------|
| Default value: 0            | Parameter type: Range, 0 - 9999 | Setup: All setups              |
| Conversion index: 0         | Data type: Uint16               | Change during operation: False |

This parameter shows a list of all the defined drive parameters available for PROFIBUS.

Parameter 9-83 Defined Parameters (4)

Table 570: Parameter 9-83 Defined Parameters (4)

| 9-83 Defined Parameters (4) |                                 |                                |
|-----------------------------|---------------------------------|--------------------------------|
| Default value: 0            | Parameter type: Range, 0 - 9999 | Setup: All setups              |
| Conversion index: 0         | Data type: Uint16               | Change during operation: False |

This parameter shows a list of all the defined drive parameters available for PROFIBUS.

## Parameter 9-84 Defined Parameters (5)

Table 571: Parameter 9-84 Defined Parameters (5)

| 9-84 Defined Parameters (5) |                                 |                                |
|-----------------------------|---------------------------------|--------------------------------|
| Default value: 0            | Parameter type: Range, 0 - 9999 | Setup: All setups              |
| Conversion index: 0         | Data type: Uint16               | Change during operation: False |

This parameter shows a list of all the defined drive parameters available for PROFIBUS.

## Parameter 9-85 Defined Parameters (6)

Table 572: Parameter 9-85 Defined Parameters (6)

| 9-85 Defined Parameters (6) |                                 |                                |
|-----------------------------|---------------------------------|--------------------------------|
| Default value: 0            | Parameter type: Range, 0 - 9999 | Setup: All setups              |
| Conversion index: 0         | Data type: Uint16               | Change during operation: False |

This parameter shows a list of all the defined drive parameters available for PROFIBUS.

## Parameter 9-90 Changed Parameters (1)

Table 573: Parameter 9-90 Changed Parameters (1)

| 9-90 Changed Parameters (1) |                                 |                                |
|-----------------------------|---------------------------------|--------------------------------|
| Default value: 0            | Parameter type: Range, 0 - 9999 | Setup: All setups              |
| Conversion index: 0         | Data type: Uint16               | Change during operation: False |

This parameters shows a list of all the drive parameters deviating from default setting.

## Parameter 9-91 Changed Parameters (2)

Table 574: Parameter 9-91 Changed Parameters (2)

| 9-91 Changed Parameters (2) |                                 |                                |
|-----------------------------|---------------------------------|--------------------------------|
| Default value: 0            | Parameter type: Range, 0 - 9999 | Setup: All setups              |
| Conversion index: 0         | Data type: Uint16               | Change during operation: False |

This parameters shows a list of all the drive parameters deviating from default setting.

## Parameter 9-92 Changed Parameters (3)

Table 575: Parameter 9-92 Changed Parameters (3)

| 9-92 Changed Parameters (3) |                                 |                                |
|-----------------------------|---------------------------------|--------------------------------|
| Default value: 0            | Parameter type: Range, 0 - 9999 | Setup: All setups              |
| Conversion index: 0         | Data type: Uint16               | Change during operation: False |

This parameters shows a list of all the drive parameters deviating from default setting.

## Parameter 9-93 Changed Parameters (4)

Table 576: Parameter 9-93 Changed Parameters (4)

| 9-93 Changed Parameters (4) |                                 |                                |
|-----------------------------|---------------------------------|--------------------------------|
| Default value: 0            | Parameter type: Range, 0 - 9999 | Setup: All setups              |
| Conversion index: 0         | Data type: Uint16               | Change during operation: False |

This parameters shows a list of all the drive parameters deviating from default setting.

Parameter 9-94 Changed Parameters (5)

Table 577: Parameter 9-94 Changed Parameters (5)

| 9-94 Changed Parameters (5) |                                 |                                |
|-----------------------------|---------------------------------|--------------------------------|
| Default value: 0            | Parameter type: Range, 0 - 9999 | Setup: All setups              |
| Conversion index: 0         | Data type: Uint16               | Change during operation: False |

This parameters shows a list of all the drive parameters deviating from default setting.

Parameter 9-99 PROFIBUS Revision Counter

Table 578: Parameter 9-99 PROFIBUS Revision Counter

| 9-99 PROFIBUS Revision Counter |                                  |                          |
|--------------------------------|----------------------------------|--------------------------|
| Default value: 0               | Parameter type: Range, 0 - 65535 | Setup: All setups        |
| Conversion index: 0            | Data type: Uint16                | Change during operation: |

Readout of revision count.

## 5.11 Parameter Group 10-\*\* CAN Fieldbus

### 5.11.1 10-0\* Common Settings

Parameter 10-00 CAN Protocol

Table 579: Parameter 10-00 CAN Protocol

| 10-00 CAN Protocol          |                        |                                |
|-----------------------------|------------------------|--------------------------------|
| Default value: Size related | Parameter type: Option | Setup: 2 setups                |
| Conversion index: –         | Data type: Uint8       | Change during operation: False |

The options available depend on the installed option card.

| Option | Name      | Description |
|--------|-----------|-------------|
| [0]    | CANopen   |             |
| [1]    | DeviceNet |             |

Parameter 10-01 Baud Rate Select

Table 580: Parameter 10-01 Baud Rate Select

| 10-01 Baud Rate Select      |                        |                               |
|-----------------------------|------------------------|-------------------------------|
| Default value: Size related | Parameter type: Option | Setup: 2 setups               |
| Conversion index: –         | Data type: Uint8       | Change during operation: True |

Select the fieldbus transmission speed. The selection must correspond to the transmission speed of the master and of the other fieldbus nodes.

| Option | Name     | Description |
|--------|----------|-------------|
| [16]   | 10 Kbps  |             |
| [17]   | 20 Kbps  |             |
| [18]   | 50 Kbps  |             |
| [19]   | 100 Kbps |             |

| Option | Name     | Description |
|--------|----------|-------------|
| [20]   | 125 Kbps |             |
| [21]   | 250 Kbps |             |
| [22]   | 500 Kbps |             |

## Parameter 10-02 MAC ID

Table 581: Parameter 10-02 MAC ID

| 10-02 MAC ID                |                              |                               |
|-----------------------------|------------------------------|-------------------------------|
| Default value: Size related | Parameter type: Range, [N/A] | Setup: 2 setups               |
| Conversion index: 0         | Data type: Uint8             | Change during operation: True |

Select the station address. Every station connected to the same network must have an unambiguous address.

## Parameter 10-05 Readout Transmit Error Counter

Table 582: Parameter 10-05 Readout Transmit Error Counter

| 10-05 Readout Transmit Error Counter |                                |                               |
|--------------------------------------|--------------------------------|-------------------------------|
| Default value: 0                     | Parameter type: Range, 0 - 255 | Setup: All setups             |
| Conversion index: 0                  | Data type: Uint8               | Change during operation: True |

View the number of CAN control transmission errors since the last power-up.

## Parameter 10-06 Readout Receive Error Counter

Table 583: Parameter 10-06 Readout Receive Error Counter

| 10-06 Readout Receive Error Counter |                                |                               |
|-------------------------------------|--------------------------------|-------------------------------|
| Default value: 0                    | Parameter type: Range, 0 - 255 | Setup: All setups             |
| Conversion index: 0                 | Data type: Uint8               | Change during operation: True |

View the number of CAN control receipt errors since the last power-up.

## Parameter 10-07 Readout Bus Off Counter

Table 584: Parameter 10-07 Readout Bus Off Counter

| 10-07 Readout Bus Off Counter |                                |                               |
|-------------------------------|--------------------------------|-------------------------------|
| Default value: 0              | Parameter type: Range, 0 - 255 | Setup: All setups             |
| Conversion index: 0           | Data type: Uint8               | Change during operation: True |

## 5.11.2 10-1\* DeviceNet

## Parameter 10-10 Process Data Type Selection

Table 585: Parameter 10-10 Process Data Type Selection

| 10-10 Process Data Type Selection |                        |                               |
|-----------------------------------|------------------------|-------------------------------|
| Default value: Size related       | Parameter type: Option | Setup: All setups             |
| Conversion index: –               | Data type: Uint8       | Change during operation: True |

Select the instance (telegram) for data transmission. The instances available depend on the setting of *parameter 8-10 Control Word Profile*. When *parameter 8-10 Control Word Profile* is set to [0] FC Profile, options [0] INSTANCE 100/150 and [1] INSTANCE 101/151 in this parameter are available. When *parameter 8-10 Control Word Profile* is set to [5] ODVA, options [2] INSTANCE 20/70 and [3] INSTANCE



21/71 in this parameter are available. Instances 100/150 and 101/151 are Danfoss specific. Instances 20/70 and 21/71 are ODVA-specific AC motor profiles. For guidelines in telegram selection, refer to the VLT® DeciveNet MCA 104 Installation Guide.

## N O T I C E

A change to this parameter is executed immediately.

| Option | Name             | Description |
|--------|------------------|-------------|
| [0]    | Instance 100/150 |             |
| [1]    | Instance 101/151 |             |
| [2]    | Instance 20/70   |             |
| [3]    | Instance 21/71   |             |
| [6]    | Instance 102/152 |             |

### Parameter 10-11 Process Data Config Write

Table 586: Parameter 10-11 Process Data Config Write

| 10-11 Process Data Config Write |                        |                               |
|---------------------------------|------------------------|-------------------------------|
| Default value: Size related     | Parameter type: Option | Setup: All setups             |
| Conversion index: –             | Data type: Uint16      | Change during operation: True |

| Option | Name                               | Description |
|--------|------------------------------------|-------------|
| [-]    | None                               |             |
| [109]  | Mode of operation                  |             |
| [302]  | Minimum reference                  |             |
| [303]  | Maximum reference                  |             |
| [312]  | Catch up/slow down value           |             |
| [321]  | Touch target                       |             |
| [322]  | Master scale numerator             |             |
| [323]  | Master scale denominator           |             |
| [326]  | Master Offset                      |             |
| [328]  | Master offset speed ref            |             |
| [341]  | Ramp 1 ramp up time                |             |
| [342]  | Ramp 1 ramp down time              |             |
| [351]  | Ramp 2 ramp up time                |             |
| [352]  | Ramp 2 ramp down time              |             |
| [361]  | Ramp 3 ramp up time                |             |
| [362]  | Ramp 3 ramp down time              |             |
| [380]  | Jog/homing ramp time jog ramp time |             |

| Option | Name                               | Description |
|--------|------------------------------------|-------------|
| [381]  | Quick stop ramp time               |             |
| [411]  | Motor speed low limit [RPM]        |             |
| [412]  | Motor speed low limit [Hz]         |             |
| [413]  | Motor speed high limit [RPM]       |             |
| [414]  | Motor speed high limit [Hz]        |             |
| [416]  | Torque limit motor mode            |             |
| [417]  | Torque limit generator mode        |             |
| [482]  | Power limit motor mode             |             |
| [483]  | Power limit generator mode         |             |
| [491]  | Positive speed limit [RPM]         |             |
| [492]  | Positive speed limit [Hz]          |             |
| [493]  | Negative speed limit [RPM]         |             |
| [494]  | Negative speed limit [Hz]          |             |
| [495]  | Positive torque limit              |             |
| [496]  | Negative torque limit              |             |
| [553]  | Term. 29 high ref./feedb. value    |             |
| [558]  | Term. 33 high ref./feedb. value    |             |
| [590]  | Digital & relay bus control        |             |
| [593]  | Pulse out #27 bus control          |             |
| [595]  | Pulse out #29 bus control          |             |
| [597]  | Pulse out #30/6 bus control        |             |
| [615]  | Terminal 53 high ref./feedb. value |             |
| [625]  | Terminal 54 high ref./feedb. value |             |
| [653]  | Term 42 output bus ctrl            |             |
| [663]  | Terminal X30/8 bus control         |             |
| [673]  | Terminal X45/1 bus control         |             |
| [683]  | Terminal X45/3 bus control         |             |
| [702]  | Speed PID proportional gain        |             |
| [703]  | Speed PID integral time            |             |
| [708]  | Speed PID feed forward factor      |             |
| [748]  | PCD feed forward                   |             |
| [890]  | Bus jog 1 speed                    |             |

| Option | Name                        | Description |
|--------|-----------------------------|-------------|
| [891]  | Bus jog 2 speed             |             |
| [1680] | Fieldbus CTW 1              |             |
| [1681] | Fieldbus sync. REF          |             |
| [1682] | Fieldbus REF 1              |             |
| [1683] | Fieldbus pos. REF           |             |
| [1685] | FC port CTW 1               |             |
| [1686] | FC port REF 1               |             |
| [1688] | Fieldbus torque FF.         |             |
| [1740] | Fieldbus sync. delta        |             |
| [1741] | Fieldbus profile velocity   |             |
| [1742] | Fieldbus velocity FF.       |             |
| [1743] | Fieldbus acceleration FF.   |             |
| [1744] | Fieldbus target velocity    |             |
| [1782] | Home position               |             |
| [1783] | Homing speed                |             |
| [1788] | Master home position        |             |
| [3310] | Sync factor master          |             |
| [3311] | Sync factor slave           |             |
| [3401] | PCD 1 write to MCO          |             |
| [3402] | PCD 2 write to MCO          |             |
| [3403] | PCD 3 write to MCO          |             |
| [3404] | PCD 4 write to MCO          |             |
| [3405] | PCD 5 write to MCO          |             |
| [3406] | PCD 6 write to MCO          |             |
| [3407] | PCD 7 write to MCO          |             |
| [3408] | PCD 8 write to MCO          |             |
| [3409] | PCD 9 write to MCO          |             |
| [3410] | PCD 10 write to MCO         |             |
| [3644] | Terminal X49/7 bus control  |             |
| [3654] | Terminal X49/9 bus control  |             |
| [3664] | Terminal X49/11 bus control |             |
| [4520] | Type                        |             |

## Parameter 10-12 Process Data Config Read

Table 587: Parameter 10-12 Process Data Config Read

| 10-12 Process Data Config Read |                        |                               |
|--------------------------------|------------------------|-------------------------------|
| Default value: Size related    | Parameter type: Option | Setup: All setups             |
| Conversion index: –            | Data type: Uint16      | Change during operation: True |

| Option | Name                  | Description |
|--------|-----------------------|-------------|
| [-]    | None                  |             |
| [15]   | Readout: actual setup |             |
| [1397] | Alert alarm word      |             |
| [1398] | Alert warning word    |             |
| [1399] | Alert status word     |             |
| [1472] | Legacy alarm word     |             |
| [1473] | Legacy warning word   |             |
| [1474] | Leg. ext. status word |             |
| [1500] | Operating hours       |             |
| [1501] | Running hours         |             |
| [1502] | kWh counter           |             |
| [1600] | Control word          |             |
| [1601] | Reference [unit]      |             |
| [1602] | Reference %           |             |
| [1603] | Status word           |             |
| [1605] | Main actual value [%] |             |
| [1606] | Actual position       |             |
| [1607] | Target position       |             |
| [1608] | Position error        |             |
| [1609] | Custom readout        |             |
| [1610] | Power [kW]            |             |
| [1611] | Power [hp]            |             |
| [1612] | Motor voltage         |             |
| [1613] | Frequency             |             |
| [1614] | Motor current         |             |
| [1615] | Frequency [%]         |             |
| [1616] | Torque [Nm]           |             |
| [1617] | Speed [RPM]           |             |

| Option | Name                          | Description |
|--------|-------------------------------|-------------|
| [1618] | Motor thermal                 |             |
| [1619] | Thermistor sensor temperature |             |
| [1620] | Motor angle                   |             |
| [1621] | Torque [%] high res.          |             |
| [1622] | Torque [%]                    |             |
| [1623] | Motor shaft power [kW]        |             |
| [1624] | Calibrated stator resistance  |             |
| [1625] | Torque [Nm] high              |             |
| [1628] | Angle error                   |             |
| [1630] | DC link voltage               |             |
| [1632] | Brake energy /s               |             |
| [1633] | Brake energy average          |             |
| [1634] | Heatsink temp.                |             |
| [1635] | Inverter thermal              |             |
| [1638] | SL controller state           |             |
| [1639] | Control card temp.            |             |
| [1642] | Service log counter           |             |
| [1644] | Speed error [RPM]             |             |
| [1645] | Motor phase U current         |             |
| [1646] | Motor phase V current         |             |
| [1647] | Motor phase W current         |             |
| [1648] | Speed ref. after ramp [RPM]   |             |
| [1650] | External reference            |             |
| [1651] | Pulse reference               |             |
| [1652] | Feedback[Unit]                |             |
| [1653] | Digi pot reference            |             |
| [1657] | Feedback [RPM]                |             |
| [1660] | Digital input                 |             |
| [1661] | Terminal 53 switch setting    |             |
| [1662] | Analog input 53               |             |
| [1663] | Terminal 54 switch setting    |             |
| [1664] | Analog input 54               |             |

| Option | Name                            | Description |
|--------|---------------------------------|-------------|
| [1665] | Analog output 42 [mA]           |             |
| [1666] | Digital output [bin]            |             |
| [1667] | Freq. input #29 [Hz]            |             |
| [1668] | Freq. input #33 [Hz]            |             |
| [1669] | Pulse output #27 [Hz]           |             |
| [1670] | Pulse output #29 [Hz]           |             |
| [1671] | Relay output [bin]              |             |
| [1672] | Counter A                       |             |
| [1673] | Counter B                       |             |
| [1674] | Prec. stop counter              |             |
| [1675] | Analog in X30/11                |             |
| [1676] | Analog in X30/12                |             |
| [1677] | Analog out X30/8 [mA]           |             |
| [1678] | Analog out X45/1 [mA]           |             |
| [1679] | Analog out X45/3 [mA]           |             |
| [1684] | Comm. option STW                |             |
| [1687] | Bus readout alarm/warning       |             |
| [1689] | Configurable alarm/warning word |             |
| [1690] | Alarm word                      |             |
| [1691] | Alarm word 2                    |             |
| [1692] | Warning word                    |             |
| [1693] | Warning word 2                  |             |
| [1694] | Ext. status word                |             |
| [1695] | Ext. status word 2              |             |
| [1696] | Maintenance word                |             |
| [1697] | Alarm word 3                    |             |
| [1698] | Warning word 3                  |             |
| [1804] | Mech brake count                |             |
| [1820] | Commanded position              |             |
| [1821] | Master position                 |             |
| [1823] | Virtual master pos.             |             |
| [1824] | Marker pos. offset              |             |

| Option | Name                      | Description |
|--------|---------------------------|-------------|
| [1825] | Latched actual pos.       |             |
| [1826] | Actual velocity [pu/s]    |             |
| [1827] | Safe opt. est. speed      |             |
| [1828] | Safe opt. meas. speed     |             |
| [1829] | Safe opt. speed error     |             |
| [1836] | Analog input X48/2 [mA]   |             |
| [1837] | Temp. input X48/4         |             |
| [1838] | Temp. input X48/7         |             |
| [1839] | Temp. input X48/10        |             |
| [1840] | Analog input X49/1        |             |
| [1841] | Analog input X49/3        |             |
| [1842] | Analog input X49/5        |             |
| [1843] | Analog input X49/7        |             |
| [1844] | Analog out X49/9          |             |
| [1845] | Analog out X49/11         |             |
| [1846] | X49 digital output [bin]  |             |
| [1860] | Digital input 2           |             |
| [1889] | Mode of operation display |             |
| [1899] | Speed PID torque FF. [Nm] |             |
| [3421] | PCD 1 read from MCO       |             |
| [3422] | PCD 2 read from MCO       |             |
| [3423] | PCD 3 read from MCO       |             |
| [3424] | PCD 4 read from MCO       |             |
| [3425] | PCD 5 read from MCO       |             |
| [3426] | PCD 6 read from MCO       |             |
| [3427] | PCD 7 read from MCO       |             |
| [3428] | PCD 8 read from MCO       |             |
| [3429] | PCD 9 read from MCO       |             |
| [3430] | PCD 10 read from MCO      |             |
| [3440] | Digital inputs            |             |
| [3441] | Digital outputs           |             |
| [3450] | Actual position           |             |

| Option | Name                         | Description |
|--------|------------------------------|-------------|
| [3451] | Commanded position           |             |
| [3452] | Actual master position       |             |
| [3453] | Slave index position         |             |
| [3454] | Master index position        |             |
| [3455] | Curve position               |             |
| [3456] | Track error                  |             |
| [3457] | Synchronizing error          |             |
| [3458] | Actual velocity              |             |
| [3459] | Actual master velocity       |             |
| [3460] | Synchronizing status         |             |
| [3461] | Axis status                  |             |
| [3462] | Program status               |             |
| [3464] | MCO 302 status               |             |
| [3465] | MCO 302 control              |             |
| [3466] | SPI error counter            |             |
| [3470] | MCO alarm word 1             |             |
| [3471] | MCO alarm word 2             |             |
| [4029] | B-EMF protection log readout |             |
| [4280] | Safe option status           |             |
| [4285] | Active safe func.            |             |
| [4521] | Status                       |             |
| [4523] | Baseline failure             |             |
| [4590] | Stator [%]                   |             |
| [4591] | Load [%]                     |             |
| [4592] | Sensor 1 [%]                 |             |
| [4593] | Sensor 1 [unit]              |             |
| [4594] | Sensor 2 [%]                 |             |
| [4595] | Sensor 2 [unit]              |             |
| [4596] | Sensor 3 [%]                 |             |
| [4597] | Sensor 3 [unit]              |             |
| [4598] | Sensor 4 [%]                 |             |
| [4599] | Sensor 4 [unit]              |             |



## Parameter 10-13 Warning Parameter

Table 588: Parameter 10-13 Warning Parameter

| 10-13 Warning Parameter |                                  |                               |
|-------------------------|----------------------------------|-------------------------------|
| Default value: 0        | Parameter type: Range, 0 - 65535 | Setup: All setups             |
| Conversion index: 0     | Data type: Uint16                | Change during operation: True |

View a DeviceNet-specific warning word. One bit is assigned to every warning. Refer to the VLT® DeviceNet MCA 104 Installation Guide for further information.

Table 589: Warning Bits

| Bit | Description                 |
|-----|-----------------------------|
| 0   | Bus not active              |
| 1   | Explicit connection timeout |
| 2   | I/O connection              |
| 3   | Retry limit reached         |
| 4   | Actual is not updated       |
| 5   | CAN bus off                 |
| 6   | I/O send error              |
| 7   | Initialization error        |
| 8   | No bus supply               |
| 9   | Bus off                     |
| 10  | Error passive               |
| 11  | Error warning               |
| 12  | Duplicate MAC ID error      |
| 13  | RX queue overrun            |
| 14  | TX queue overrun            |
| 15  | CAN overrun                 |

## Parameter 10-14 Net Reference

Table 590: Parameter 10-14 Net Reference

| 10-14 Net Reference    |                        |                               |
|------------------------|------------------------|-------------------------------|
| Default value: [0] Off | Parameter type: Option | Setup: 2 setups               |
| Conversion index: –    | Data type: Uint8       | Change during operation: True |

Select the reference source in instances 21/71 and 20/70.

| Option | Name | Description |
|--------|------|-------------|
| [0]*   | Off  |             |
| [1]    | On   |             |

## Parameter 10-15 Net Control

Table 591: Parameter 10-15 Net Control

| 10-15 Net Control      |                        |                               |
|------------------------|------------------------|-------------------------------|
| Default value: [0] Off | Parameter type: Option | Setup: 2 setups               |
| Conversion index: –    | Data type: Uint8       | Change during operation: True |

Select the control source in instances 21/71 and 20/70.

| Option | Name | Description |
|--------|------|-------------|
| [0]*   | Off  |             |
| [1]    | On   |             |

## 5.11.3 10-2\* COS Filters

## Parameter 10-20 COS Filter 1

Table 592: Parameter 10-20 COS Filter 1

| 10-20 COS Filter 1  |                                  |                                |
|---------------------|----------------------------------|--------------------------------|
| Default value: 0    | Parameter type: Range, 0 - 65535 | Setup: All setups              |
| Conversion index: 0 | Data type: Uint16                | Change during operation: False |

Sets up the filter mask for the status word. When operating in COS (change-of-state), it is possible to filter out bits in the status word that should not be sent if they change.

## Parameter 10-21 COS Filter 2

Table 593: Parameter 10-21 COS Filter 2

| 10-21 COS Filter 2  |                                  |                                |
|---------------------|----------------------------------|--------------------------------|
| Default value: 0    | Parameter type: Range, 0 - 65535 | Setup: All setups              |
| Conversion index: 0 | Data type: Uint16                | Change during operation: False |

Sets up the filter mask for the main actual value. When operating in COS (change-of-state), it is possible to filter out bits in the main actual value that should not be sent if they change.

## Parameter 10-22 COS Filter 3

Table 594: Parameter 10-22 COS Filter 3

| 10-22 COS Filter 3  |                                  |                                |
|---------------------|----------------------------------|--------------------------------|
| Default value: 0    | Parameter type: Range, 0 - 65535 | Setup: All setups              |
| Conversion index: 0 | Data type: Uint16                | Change during operation: False |

Sets up the filter mask for PCD 3. When operating in COS (change-of-state), it is possible to filter out bits in PCD 3 that should not be sent if they change.

## Parameter 10-23 COS Filter 4

Table 595: Parameter 10-23 COS Filter 4

| 10-23 COS Filter 4  |                                  |                                |
|---------------------|----------------------------------|--------------------------------|
| Default value: 0    | Parameter type: Range, 0 - 65535 | Setup: All setups              |
| Conversion index: 0 | Data type: Uint16                | Change during operation: False |

Sets up the filter mask for PCD 4. When operating in COS (change-of-state), it is possible to filter out bits in PCD 4 that should not be sent if they change.

### 5.11.4 10-3\* Parameter Access

#### Parameter 10-30 Array Index

Table 596: Parameter 10-30 Array Index

| 10-30 Array Index   |                                |                               |
|---------------------|--------------------------------|-------------------------------|
| Default value: 0    | Parameter type: Range, 0 - 255 | Setup: 2 setups               |
| Conversion index: 0 | Data type: Uint8               | Change during operation: True |

View array parameters. This parameter is only valid when a VLT® DeviceNet MCA 104 is installed.

#### Parameter 10-31 Store Data Values

Table 597: Parameter 10-31 Store Data Values

| 10-31 Store Data Values |                        |                               |
|-------------------------|------------------------|-------------------------------|
| Default value: [0] Off  | Parameter type: Option | Setup: All setups             |
| Conversion index: –     | Data type: Uint8       | Change during operation: True |

This parameter is used to activate a function that stores all parameter values in the non-volatile memory, this retaining changed parameter values at power-down.

| Option | Name             | Description |
|--------|------------------|-------------|
| [0]*   | Off              |             |
| [1]    | Store all setups |             |
| [2]    | Store all setups |             |

#### Parameter 10-32 Devicenet Revision

Table 598: Parameter 10-32 Devicenet Revision

| 10-32 Devicenet Revision    |                                  |                               |
|-----------------------------|----------------------------------|-------------------------------|
| Default value: Size related | Parameter type: Range, 0 - 65535 | Setup: All setups             |
| Conversion index: 0         | Data type: Uint16                | Change during operation: True |

The DeviceNet revision number. This parameter is used for EDS file creation.

#### Parameter 10-33 Store Always

Table 599: Parameter 10-33 Store Always

| 10-33 Store Always     |                        |                               |
|------------------------|------------------------|-------------------------------|
| Default value: [0] Off | Parameter type: Option | Setup: 1 setup                |
| Conversion index: –    | Data type: Uint8       | Change during operation: True |

This parameter is used to select whether parameter data received via the DeviceNet option should always be stored in non-volatile memory.

| Option | Name | Description |
|--------|------|-------------|
| [0]*   | Off  |             |
| [1]    | On   |             |

## Parameter 10-34 DeviceNet Product Code

Table 600: Parameter 10-34 DeviceNet Product Code

| 10-34 DeviceNet Product Code |                                  |                               |
|------------------------------|----------------------------------|-------------------------------|
| Default value: Size related  | Parameter type: Range, 0 - 65535 | Setup: 1 setup                |
| Conversion index: 0          | Data type: Uint16                | Change during operation: True |

Use this parameter for reading out the actual DeviceNet product code.

## Parameter 10-39 Devicenet F Parameters

Table 601: Parameter 10-39 Devicenet F Parameters

| 10-39 Devicenet F Parameters |                              |                          |
|------------------------------|------------------------------|--------------------------|
| Default value: 0             | Parameter type: Range, 0 - 0 | Setup: All setups        |
| Conversion index: 0          | Data type: Uint32            | Change during operation: |

Use this parameter to configure the drive via DeviceNet and build the EDS file.

## 5.11.5 10-5\* CANopen

## Parameter 10-50 Process Data Config Write

Table 602: Parameter 10-50 Process Data Config Write

| 10-50 Process Data Config Write |                                    |                               |
|---------------------------------|------------------------------------|-------------------------------|
| Default value: Size related     | Parameter type: Option, Array [81] | Setup: All setups             |
| Conversion index: –             | Data type: Uint16                  | Change during operation: True |

Only elements [2] and [3] of this array can be selected. [0] and [1] are fixed.

| Option | Name                     | Description |
|--------|--------------------------|-------------|
| [-]    | None                     |             |
| [109]  | Mode of operation        |             |
| [302]  | Minimum reference        |             |
| [303]  | Maximum reference        |             |
| [312]  | Catch up/slow down value |             |
| [321]  | Touch target             |             |
| [322]  | Master scale numerator   |             |
| [323]  | Master scale denominator |             |
| [326]  | Master Offset            |             |
| [328]  | Master offset speed ref  |             |
| [341]  | Ramp 1 ramp up time      |             |
| [342]  | Ramp 1 ramp down time    |             |
| [351]  | Ramp 2 ramp up time      |             |
| [352]  | Ramp 2 ramp down time    |             |

| Option | Name                               | Description |
|--------|------------------------------------|-------------|
| [361]  | Ramp 3 ramp up time                |             |
| [362]  | Ramp 3 ramp down time              |             |
| [380]  | Jog/homing ramp time jog ramp time |             |
| [381]  | Quick stop ramp time               |             |
| [411]  | Motor speed low limit [RPM]        |             |
| [412]  | Motor speed low limit [Hz]         |             |
| [413]  | Motor speed high limit [RPM]       |             |
| [414]  | Motor speed high limit [Hz]        |             |
| [416]  | Torque limit motor mode            |             |
| [417]  | Torque limit generator mode        |             |
| [482]  | Power limit motor mode             |             |
| [483]  | Power limit generator mode         |             |
| [491]  | Positive speed limit [RPM]         |             |
| [492]  | Positive speed limit [Hz]          |             |
| [493]  | Negative speed limit [RPM]         |             |
| [494]  | Negative speed limit [Hz]          |             |
| [495]  | Positive torque limit              |             |
| [496]  | Negative torque limit              |             |
| [553]  | Term. 29 high ref./feedb. value    |             |
| [558]  | Term. 33 high ref./feedb. value    |             |
| [590]  | Digital & relay bus control        |             |
| [593]  | Pulse out #27 bus control          |             |
| [595]  | Pulse out #29 bus control          |             |
| [597]  | Pulse out #30/6 bus control        |             |
| [615]  | Terminal 53 high ref./feedb. value |             |
| [625]  | Terminal 54 high ref./feedb. value |             |
| [653]  | Term 42 output bus ctrl            |             |
| [663]  | Terminal X30/8 bus control         |             |
| [673]  | Terminal X45/1 bus control         |             |
| [683]  | Terminal X45/3 bus control         |             |
| [702]  | Speed PID proportional gain        |             |
| [703]  | Speed PID integral time            |             |

| Option | Name                          | Description |
|--------|-------------------------------|-------------|
| [708]  | Speed PID feed forward factor |             |
| [748]  | PCD feed forward              |             |
| [890]  | Bus jog 1 speed               |             |
| [891]  | Bus jog 2 speed               |             |
| [1680] | Fieldbus CTW 1                |             |
| [1681] | Fieldbus sync. REF            |             |
| [1682] | Fieldbus REF 1                |             |
| [1683] | Fieldbus pos. REF             |             |
| [1685] | FC port CTW 1                 |             |
| [1686] | FC port REF 1                 |             |
| [1688] | Fieldbus torque FF.           |             |
| [1740] | Fieldbus sync. delta          |             |
| [1741] | Fieldbus profile velocity     |             |
| [1742] | Fieldbus velocity FF.         |             |
| [1743] | Fieldbus acceleration FF.     |             |
| [1744] | Fieldbus target velocity      |             |
| [1782] | Home position                 |             |
| [1783] | Homing speed                  |             |
| [1788] | Master home position          |             |
| [3310] | Sync factor master            |             |
| [3311] | Sync factor slave             |             |
| [3401] | PCD 1 write to MCO            |             |
| [3402] | PCD 2 write to MCO            |             |
| [3403] | PCD 3 write to MCO            |             |
| [3404] | PCD 4 write to MCO            |             |
| [3405] | PCD 5 write to MCO            |             |
| [3406] | PCD 6 write to MCO            |             |
| [3407] | PCD 7 write to MCO            |             |
| [3408] | PCD 8 write to MCO            |             |
| [3409] | PCD 9 write to MCO            |             |
| [3410] | PCD 10 write to MCO           |             |
| [3644] | Terminal X49/7 bus control    |             |

| Option | Name                        | Description |
|--------|-----------------------------|-------------|
| [3654] | Terminal X49/9 bus control  |             |
| [3664] | Terminal X49/11 bus control |             |
| [4520] | Type                        |             |

## Parameter 10-51 Process Data Config Read

Table 603: Parameter 10-51 Process Data Config Read

| 10-51 Process Data Config Read |                                     |                               |
|--------------------------------|-------------------------------------|-------------------------------|
| Default value: Size related    | Parameter type: Option, Array [156] | Setup: All setups             |
| Conversion index: –            | Data type: Uint16                   | Change during operation: True |

Only elements [2] and [3] of this array can be selected. [0] and [1] are fixed.

| Option | Name                  | Description |
|--------|-----------------------|-------------|
| [-]    | None                  |             |
| [15]   | Readout: actual setup |             |
| [1397] | Alert alarm word      |             |
| [1398] | Alert warning word    |             |
| [1399] | Alert status word     |             |
| [1472] | Legacy alarm word     |             |
| [1473] | Legacy warning word   |             |
| [1474] | Leg. ext. status word |             |
| [1500] | Operating hours       |             |
| [1501] | Running hours         |             |
| [1502] | kWh counter           |             |
| [1600] | Control word          |             |
| [1601] | Reference [unit]      |             |
| [1602] | Reference %           |             |
| [1603] | Status word           |             |
| [1605] | Main actual value [%] |             |
| [1606] | Actual position       |             |
| [1607] | Target position       |             |
| [1608] | Position error        |             |
| [1609] | Custom readout        |             |
| [1610] | Power [kW]            |             |
| [1611] | Power [hp]            |             |

| Option | Name                          | Description |
|--------|-------------------------------|-------------|
| [1612] | Motor voltage                 |             |
| [1613] | Frequency                     |             |
| [1614] | Motor current                 |             |
| [1615] | Frequency [%]                 |             |
| [1616] | Torque [Nm]                   |             |
| [1617] | Speed [RPM]                   |             |
| [1618] | Motor thermal                 |             |
| [1619] | Thermistor sensor temperature |             |
| [1620] | Motor angle                   |             |
| [1621] | Torque [%] high res.          |             |
| [1622] | Torque [%]                    |             |
| [1623] | Motor shaft power [kW]        |             |
| [1624] | Calibrated stator resistance  |             |
| [1625] | Torque [Nm] high              |             |
| [1628] | Angle error                   |             |
| [1630] | DC link voltage               |             |
| [1632] | Brake energy /s               |             |
| [1633] | Brake energy average          |             |
| [1634] | Heatsink temp.                |             |
| [1635] | Inverter thermal              |             |
| [1638] | SL controller state           |             |
| [1639] | Control card temp.            |             |
| [1642] | Service log counter           |             |
| [1644] | Speed error [RPM]             |             |
| [1645] | Motor phase U current         |             |
| [1646] | Motor phase V current         |             |
| [1647] | Motor phase W current         |             |
| [1648] | Speed ref. after ramp [RPM]   |             |
| [1650] | External reference            |             |
| [1651] | Pulse reference               |             |
| [1652] | Feedback[Unit]                |             |
| [1653] | Digi pot reference            |             |



| Option | Name                            | Description |
|--------|---------------------------------|-------------|
| [1657] | Feedback [RPM]                  |             |
| [1660] | Digital input                   |             |
| [1661] | Terminal 53 switch setting      |             |
| [1662] | Analog input 53                 |             |
| [1663] | Terminal 54 switch setting      |             |
| [1664] | Analog input 54                 |             |
| [1665] | Analog output 42 [mA]           |             |
| [1666] | Digital output [bin]            |             |
| [1667] | Freq. input #29 [Hz]            |             |
| [1668] | Freq. input #33 [Hz]            |             |
| [1669] | Pulse output #27 [Hz]           |             |
| [1670] | Pulse output #29 [Hz]           |             |
| [1671] | Relay output [bin]              |             |
| [1672] | Counter A                       |             |
| [1673] | Counter B                       |             |
| [1674] | Prec. stop counter              |             |
| [1675] | Analog in X30/11                |             |
| [1676] | Analog in X30/12                |             |
| [1677] | Analog out X30/8 [mA]           |             |
| [1678] | Analog out X45/1 [mA]           |             |
| [1679] | Analog out X45/3 [mA]           |             |
| [1684] | Comm. option STW                |             |
| [1687] | Bus readout alarm/warning       |             |
| [1689] | Configurable alarm/warning word |             |
| [1690] | Alarm word                      |             |
| [1691] | Alarm word 2                    |             |
| [1692] | Warning word                    |             |
| [1693] | Warning word 2                  |             |
| [1694] | Ext. status word                |             |
| [1695] | Ext. status word 2              |             |
| [1696] | Maintenance word                |             |
| [1697] | Alarm word 3                    |             |

| Option | Name                      | Description |
|--------|---------------------------|-------------|
| [1698] | Warning word 3            |             |
| [1804] | Mech brake count          |             |
| [1820] | Commanded position        |             |
| [1821] | Master position           |             |
| [1823] | Virtual master pos.       |             |
| [1824] | Marker pos. offset        |             |
| [1825] | Latched actual pos.       |             |
| [1826] | Actual velocity [pu/s]    |             |
| [1827] | Safe opt. est. speed      |             |
| [1828] | Safe opt. meas. speed     |             |
| [1829] | Safe opt. speed error     |             |
| [1836] | Analog input X48/2 [mA]   |             |
| [1837] | Temp. input X48/4         |             |
| [1838] | Temp. input X48/7         |             |
| [1839] | Temp. input X48/10        |             |
| [1840] | Analog input X49/1        |             |
| [1841] | Analog input X49/3        |             |
| [1842] | Analog input X49/5        |             |
| [1843] | Analog input X49/7        |             |
| [1844] | Analog out X49/9          |             |
| [1845] | Analog out X49/11         |             |
| [1846] | X49 digital output [bin]  |             |
| [1860] | Digital input 2           |             |
| [1889] | Mode of operation display |             |
| [1899] | Speed PID torque FF. [Nm] |             |
| [3421] | PCD 1 read from MCO       |             |
| [3422] | PCD 2 read from MCO       |             |
| [3423] | PCD 3 read from MCO       |             |
| [3424] | PCD 4 read from MCO       |             |
| [3425] | PCD 5 read from MCO       |             |
| [3426] | PCD 6 read from MCO       |             |
| [3427] | PCD 7 read from MCO       |             |

| Option | Name                         | Description |
|--------|------------------------------|-------------|
| [3428] | PCD 8 read from MCO          |             |
| [3429] | PCD 9 read from MCO          |             |
| [3430] | PCD 10 read from MCO         |             |
| [3440] | Digital inputs               |             |
| [3441] | Digital outputs              |             |
| [3450] | Actual position              |             |
| [3451] | Commanded position           |             |
| [3452] | Actual master position       |             |
| [3453] | Slave index position         |             |
| [3454] | Master index position        |             |
| [3455] | Curve position               |             |
| [3456] | Track error                  |             |
| [3457] | Synchronizing error          |             |
| [3458] | Actual velocity              |             |
| [3459] | Actual master velocity       |             |
| [3460] | Synchronizing status         |             |
| [3461] | Axis status                  |             |
| [3462] | Program status               |             |
| [3464] | MCO 302 status               |             |
| [3465] | MCO 302 control              |             |
| [3466] | SPI error counter            |             |
| [3470] | MCO alarm word 1             |             |
| [3471] | MCO alarm word 2             |             |
| [4029] | B-EMF protection log readout |             |
| [4280] | Safe option status           |             |
| [4285] | Active safe func.            |             |
| [4521] | Status                       |             |
| [4523] | Baseline failure             |             |
| [4590] | Stator [%]                   |             |
| [4591] | Load [%]                     |             |
| [4592] | Sensor 1 [%]                 |             |
| [4593] | Sensor 1 [unit]              |             |

| Option | Name            | Description |
|--------|-----------------|-------------|
| [4594] | Sensor 2 [%]    |             |
| [4595] | Sensor 2 [unit] |             |
| [4596] | Sensor 3 [%]    |             |
| [4597] | Sensor 3 [unit] |             |
| [4598] | Sensor 4 [%]    |             |
| [4599] | Sensor 4 [unit] |             |

## 5.12 Parameter Group 12-\*\* Ethernet

### 5.12.1 12-0\* IP Settings

#### Parameter 12-01 IP Address

Table 604: Parameter 12-01 IP Address

| 12-01 IP Address    |                                       |                               |
|---------------------|---------------------------------------|-------------------------------|
| Default value: 0    | Parameter type: Range, 0 - 4294967295 | Setup: 1 setup                |
| Conversion index: 0 | Data type: OctetString                | Change during operation: True |

Configure the IP address of the option. Read-only if *parameter 12-00 IP Address Assignment* is set to [1] DHCP, [2] BOOTP, or via DIP switches. In POWERLINK, the IP address follows the last byte of *parameter 12-60 Node ID* and the 1<sup>st</sup> part is fixed to 192.168.100 (node ID).

#### Parameter 12-02 Subnet Mask

Table 605: Parameter 12-02 Subnet Mask

| 12-02 Subnet Mask   |                                       |                               |
|---------------------|---------------------------------------|-------------------------------|
| Default value: 0    | Parameter type: Range, 0 - 4294967295 | Setup: 1 setup                |
| Conversion index: 0 | Data type: OctetString                | Change during operation: True |

Configure the IP subnet mask of the option. Read-only if *parameter 12-00 IP Address Assignment* is set to [1] DHCP or [2] BOOTP. In POWERLINK, it is fixed to 255.255.255.0

#### Parameter 12-03 Default Gateway

Table 606: Parameter 12-03 Default Gateway

| 12-03 Default Gateway |                                       |                               |
|-----------------------|---------------------------------------|-------------------------------|
| Default value: 0      | Parameter type: Range, 0 - 4294967295 | Setup: 1 setup                |
| Conversion index: 0   | Data type: OctetString                | Change during operation: True |

Configure the IP default gateway of the option. Read-only if *parameter 12-00 IP Address Assignment* set to [1] DHCP or [2] BOOTP. In a non-routed network, this address is set to the IP address of the I/O device.

#### Parameter 12-04 DHCP Server

Table 607: Parameter 12-04 DHCP Server

| 12-04 DHCP Server   |                                       |                               |
|---------------------|---------------------------------------|-------------------------------|
| Default value: 0    | Parameter type: Range, 0 - 2147483647 | Setup: 2 setups               |
| Conversion index: 0 | Data type: OctetString                | Change during operation: True |

## N O T I C E

A power cycle is necessary after setting the IP parameters manually.

This parameter is read-only. It shows the IP address of the found DHCP or BOOTP server.

Parameter 12-05 Lease Expires

**Table 608: Parameter 12-05 Lease Expires**

| 12-05 Lease Expires         |   |                               |
|-----------------------------|---|-------------------------------|
| Default value: Size related | Parameter type: Range, Size related         | Setup: All setups             |
| Conversion index: 0         | Data type: TimeDifferenceWithDateIndication | Change during operation: True |

This parameter is read-only. It shows the lease time for the current DHCP-assigned IP address.

Parameter 12-06 Name Servers

**Table 609: Parameter 12-06 Name Servers**

| 12-06 Name Servers  |                                      |                               |
|---------------------|--------------------------------------|-------------------------------|
| Default value: 0    | Parameter type: Range, 0 -4294967295 | Setup: All setups             |
| Conversion index: 0 | Data type: OctetString               | Change during operation: True |

IP addresses of the domain name servers. Can be automatically assigned when using DHCP.

Parameter 12-07 Domain Name

**Table 610: Parameter 12-07 Domain Name**

| 12-07 Domain Name   |                               |                               |
|---------------------|-------------------------------|-------------------------------|
| Default value: 0    | Parameter type: Range, 0 - 48 | Setup: 1 setup                |
| Conversion index: 0 | Data type: VisibleString      | Change during operation: True |

Domain name of the attached network. Can be automatically assigned when using DHCP network.

Parameter 12-08 Host Name

**Table 611: Parameter 12-08 Host Name**

| 12-08 Host Name     |                               |                               |
|---------------------|-------------------------------|-------------------------------|
| Default value: 0    | Parameter type: Range, 0 - 48 | Setup: 1 setup                |
| Conversion index: 0 | Data type: VisibleString      | Change during operation: True |

Logical (given) name of the option.

## N O T I C E

The display of the drive only shows the 1<sup>st</sup> 19 characters, but the remaining characters are stored in the drive. If hardware switches are different from all ON or all OFF, the switches have priority.

Parameter 12-09 Physical Address

**Table 612: Parameter 12-09 Physical Address**

| 12-09 Physical Address |                               |                               |
|------------------------|-------------------------------|-------------------------------|
| Default value: 0       | Parameter type: Range, 0 - 17 | Setup: 1 setup                |
| Conversion index: 0    | Data type: VisibleString      | Change during operation: True |

This parameter is read-only. It shows the physical (MAC) address of the option.

## 5.12.2 12-1\* Ethernet Link Parameters

### Parameter 12-10 Link Status

Table 613: Parameter 12-10 Link Status

| 12-10 Link Status          |                        |                               |
|----------------------------|------------------------|-------------------------------|
| Default value: [0] No link | Parameter type: Option | Setup: All setups             |
| Conversion index: –        | Data type: Uint8       | Change during operation: True |

This parameter is read-only. It shows the link status of the Ethernet ports. Index [0] is used for port 1, and index [1] is used for port 2. For EtherCAT, index [0] is for the in-port, and index [1] is for the out-port.

| Option | Name    | Description |
|--------|---------|-------------|
| [0]*   | No link |             |
| [1]    | Link    |             |

### Parameter 12-11 Link Duration

Table 614: Parameter 12-11 Link Duration

| 12-11 Link Duration         |   |                               |
|-----------------------------|---|-------------------------------|
| Default value: Size related | Parameter type: Range, Size related         | Setup: All setups             |
| Conversion index: 0         | Data type: TimeDifferenceWithDateIndication | Change during operation: True |

Shows the duration of the present link on each port in dd:hh:mm:ss.

### Parameter 12-12 Auto Negotiation

Table 615: Parameter 12-12 Auto Negotiation

| 12-12 Auto Negotiation      |                        |                               |
|-----------------------------|------------------------|-------------------------------|
| Default value: Size related | Parameter type: Option | Setup: All setups             |
| Conversion index: –         | Data type: Uint8       | Change during operation: True |

Configures auto negotiation of Ethernet link parameters, for each port: ON or OFF. Link Speed and Link Duplex can be configured in *parameter 12-13 Link Speed* and *parameter 12-14 Link Duplex*.

| Option | Name | Description |
|--------|------|-------------|
| [0]    | Off  |             |
| [1]    | On   |             |

### Parameter 12-13 Link Speed

Table 616: Parameter 12-13 Link Speed

| 12-13 Link Speed            |                        |                               |
|-----------------------------|------------------------|-------------------------------|
| Default value: Size related | Parameter type: Option | Setup: All setups             |
| Conversion index: –         | Data type: Uint8       | Change during operation: True |

Forces the link speed for each port in 10 Mbps or 100 Mbps. If *parameter 12-12 Auto Negotiation* is set to [0] On, this parameter is read-only and shows the actual link speed. If no link is present, None is shown.

| Option | Name     | Description |
|--------|----------|-------------|
| [0]    | None     |             |
| [1]    | 10 Mbps  |             |
| [2]    | 100 Mbps |             |

### Parameter 12-14 Link Duplex

Table 617: Parameter 12-14 Link Duplex

| 12-14 Link Duplex           |                        |                               |
|-----------------------------|------------------------|-------------------------------|
| Default value: Size related | Parameter type: Option | Setup: All setups             |
| Conversion index: –         | Data type: Uint8       | Change during operation: True |

## N O T I C E

In POWERLINK, this parameter is locked to half duplex.

Forces the duplex for each port to full or half duplex. If *parameter 12-12 Auto Negotiation* is set to [1] On, this parameter is read-only.

| Option | Name        | Description |
|--------|-------------|-------------|
| [0]    | Half duplex |             |
| [1]    | Full duplex |             |

### Parameter 12-18 Supervisor MAC

Table 618: Parameter 12-18 Supervisor MAC

| 12-18 Supervisor MAC |                                       |                               |
|----------------------|---------------------------------------|-------------------------------|
| Default value: 0     | Parameter type: Range, 0 - 2147483647 | Setup: All setups             |
| Conversion index: 0  | Data type: OctetString                | Change during operation: True |

MAC addresses of currently active supervisors.

### Parameter 12-19 Supervisor IP Addr.

Table 619: Parameter 12-19 Supervisor IP Addr.

| 12-19 Supervisor IP Addr. |                                       |                               |
|---------------------------|---------------------------------------|-------------------------------|
| Default value: 0          | Parameter type: Range, 0 - 2147483647 | Setup: All setups             |
| Conversion index: 0       | Data type: OctetString                | Change during operation: True |

IP addresses of currently active supervisors.

## 5.12.3 12-2\* Process Data

### Parameter 12-20 Control Instance

Table 620: Parameter 12-20 Control Instance

| 12-20 Control Instance      |                                |                               |
|-----------------------------|--------------------------------|-------------------------------|
| Default value: Size related | Parameter type: Range, 0 - 255 | Setup: 1 setup                |
| Conversion index: 0         | Data type: Uint8               | Change during operation: True |

This parameter is read-only. It shows the connection to the master.

- In Ethernet/IP: If no CIP connection is present, None is shown.
- In EtherCAT: If no connection is active, None is shown, otherwise it shows the active PDO.
- In POWERLINK: If no connection is active, None is shown, otherwise it shows the active PDO (23).

## Parameter 12-21 Process Data Config Write

Table 621: Parameter 12-21 Process Data Config Write

| 12-21 Process Data Config Write |                                    |                               |
|---------------------------------|------------------------------------|-------------------------------|
| Default value: Size related     | Parameter type: Option, Array [81] | Setup: All setups             |
| Conversion index: –             | Data type: Uint16                  | Change during operation: True |

| Option | Name                               | Description |
|--------|------------------------------------|-------------|
| [-]    | None                               |             |
| [109]  | Mode of operation                  |             |
| [302]  | Minimum reference                  |             |
| [303]  | Maximum reference                  |             |
| [312]  | Catch up/slow down value           |             |
| [321]  | Touch target                       |             |
| [322]  | Master scale numerator             |             |
| [323]  | Master scale denominator           |             |
| [326]  | Master Offset                      |             |
| [328]  | Master offset speed ref            |             |
| [341]  | Ramp 1 ramp up time                |             |
| [342]  | Ramp 1 ramp down time              |             |
| [351]  | Ramp 2 ramp up time                |             |
| [352]  | Ramp 2 ramp down time              |             |
| [361]  | Ramp 3 ramp up time                |             |
| [362]  | Ramp 3 ramp down time              |             |
| [380]  | Jog/homing ramp time jog ramp time |             |
| [381]  | Quick stop ramp time               |             |
| [411]  | Motor speed low limit [RPM]        |             |
| [412]  | Motor speed low limit [Hz]         |             |
| [413]  | Motor speed high limit [RPM]       |             |
| [414]  | Motor speed high limit [Hz]        |             |
| [416]  | Torque limit motor mode            |             |
| [417]  | Torque limit generator mode        |             |
| [482]  | Power limit motor mode             |             |



| Option | Name                               | Description |
|--------|------------------------------------|-------------|
| [483]  | Power limit generator mode         |             |
| [491]  | Positive speed limit [RPM]         |             |
| [492]  | Positive speed limit [Hz]          |             |
| [493]  | Negative speed limit [RPM]         |             |
| [494]  | Negative speed limit [Hz]          |             |
| [495]  | Positive torque limit              |             |
| [496]  | Negative torque limit              |             |
| [553]  | Term. 29 high ref./feedb. value    |             |
| [558]  | Term. 33 high ref./feedb. value    |             |
| [590]  | Digital & relay bus control        |             |
| [593]  | Pulse out #27 bus control          |             |
| [595]  | Pulse out #29 bus control          |             |
| [597]  | Pulse out #30/6 bus control        |             |
| [615]  | Terminal 53 high ref./feedb. value |             |
| [625]  | Terminal 54 high ref./feedb. value |             |
| [653]  | Term 42 output bus ctrl            |             |
| [663]  | Terminal X30/8 bus control         |             |
| [673]  | Terminal X45/1 bus control         |             |
| [683]  | Terminal X45/3 bus control         |             |
| [702]  | Speed PID proportional gain        |             |
| [703]  | Speed PID integral time            |             |
| [708]  | Speed PID feed forward factor      |             |
| [748]  | PCD feed forward                   |             |
| [890]  | Bus jog 1 speed                    |             |
| [891]  | Bus jog 2 speed                    |             |
| [1680] | Fieldbus CTW 1                     |             |
| [1681] | Fieldbus sync. REF                 |             |
| [1682] | Fieldbus REF 1                     |             |
| [1683] | Fieldbus pos. REF                  |             |
| [1685] | FC port CTW 1                      |             |
| [1686] | FC port REF 1                      |             |
| [1688] | Fieldbus torque FF.                |             |

| Option | Name                        | Description |
|--------|-----------------------------|-------------|
| [1740] | Fieldbus sync. delta        |             |
| [1741] | Fieldbus profile velocity   |             |
| [1742] | Fieldbus velocity FF.       |             |
| [1743] | Fieldbus acceleration FF.   |             |
| [1744] | Fieldbus target velocity    |             |
| [1782] | Home position               |             |
| [1783] | Homing speed                |             |
| [1788] | Master home position        |             |
| [3310] | Sync factor master          |             |
| [3311] | Sync factor slave           |             |
| [3401] | PCD 1 write to MCO          |             |
| [3402] | PCD 2 write to MCO          |             |
| [3403] | PCD 3 write to MCO          |             |
| [3404] | PCD 4 write to MCO          |             |
| [3405] | PCD 5 write to MCO          |             |
| [3406] | PCD 6 write to MCO          |             |
| [3407] | PCD 7 write to MCO          |             |
| [3408] | PCD 8 write to MCO          |             |
| [3409] | PCD 9 write to MCO          |             |
| [3410] | PCD 10 write to MCO         |             |
| [3644] | Terminal X49/7 bus control  |             |
| [3654] | Terminal X49/9 bus control  |             |
| [3664] | Terminal X49/11 bus control |             |
| [4520] | Type                        |             |

Parameter 12-22 Process Data Config Read

Table 622: Parameter 12-22 Process Data Config Read

| 12-22 Process Data Config Read |                                     |                               |
|--------------------------------|-------------------------------------|-------------------------------|
| Default value: Size related    | Parameter type: Option, Array [156] | Setup: All setups             |
| Conversion index: –            | Data type: Uint16                   | Change during operation: True |

| Option | Name                  | Description |
|--------|-----------------------|-------------|
| [0]    | None                  |             |
| [15]   | Readout: actual setup |             |

| Option | Name                          | Description |
|--------|-------------------------------|-------------|
| [1397] | Alert alarm word              |             |
| [1398] | Alert warning word            |             |
| [1399] | Alert status word             |             |
| [1472] | Legacy alarm word             |             |
| [1473] | Legacy warning word           |             |
| [1474] | Leg. ext. status word         |             |
| [1500] | Operating hours               |             |
| [1501] | Running hours                 |             |
| [1502] | kWh counter                   |             |
| [1600] | Control word                  |             |
| [1601] | Reference [unit]              |             |
| [1602] | Reference %                   |             |
| [1603] | Status word                   |             |
| [1605] | Main actual value [%]         |             |
| [1606] | Actual position               |             |
| [1607] | Target position               |             |
| [1608] | Position error                |             |
| [1609] | Custom readout                |             |
| [1610] | Power [kW]                    |             |
| [1611] | Power [hp]                    |             |
| [1612] | Motor voltage                 |             |
| [1613] | Frequency                     |             |
| [1614] | Motor current                 |             |
| [1615] | Frequency [%]                 |             |
| [1616] | Torque [Nm]                   |             |
| [1617] | Speed [RPM]                   |             |
| [1618] | Motor thermal                 |             |
| [1619] | Thermistor sensor temperature |             |
| [1620] | Motor angle                   |             |
| [1621] | Torque [%] high res.          |             |
| [1622] | Torque [%]                    |             |
| [1623] | Motor shaft power [kW]        |             |

| Option | Name                         | Description |
|--------|------------------------------|-------------|
| [1624] | Calibrated stator resistance |             |
| [1625] | Torque [Nm] high             |             |
| [1628] | Angle error                  |             |
| [1630] | DC link voltage              |             |
| [1632] | Brake energy /s              |             |
| [1633] | Brake energy average         |             |
| [1634] | Heatsink temp.               |             |
| [1635] | Inverter thermal             |             |
| [1638] | SL controller state          |             |
| [1639] | Control card temp.           |             |
| [1642] | Service log counter          |             |
| [1644] | Speed error [RPM]            |             |
| [1645] | Motor phase U current        |             |
| [1646] | Motor phase V current        |             |
| [1647] | Motor phase W current        |             |
| [1648] | Speed ref. after ramp [RPM]  |             |
| [1650] | External reference           |             |
| [1651] | Pulse reference              |             |
| [1652] | Feedback[Unit]               |             |
| [1653] | Digi pot reference           |             |
| [1657] | Feedback [RPM]               |             |
| [1660] | Digital input                |             |
| [1661] | Terminal 53 switch setting   |             |
| [1662] | Analog input 53              |             |
| [1663] | Terminal 54 switch setting   |             |
| [1664] | Analog input 54              |             |
| [1665] | Analog output 42 [mA]        |             |
| [1666] | Digital output [bin]         |             |
| [1667] | Freq. input #29 [Hz]         |             |
| [1668] | Freq. input #33 [Hz]         |             |
| [1669] | Pulse output #27 [Hz]        |             |
| [1670] | Pulse output #29 [Hz]        |             |

| Option | Name                            | Description |
|--------|---------------------------------|-------------|
| [1671] | Relay output [bin]              |             |
| [1672] | Counter A                       |             |
| [1673] | Counter B                       |             |
| [1674] | Prec. stop counter              |             |
| [1675] | Analog in X30/11                |             |
| [1676] | Analog in X30/12                |             |
| [1677] | Analog out X30/8 [mA]           |             |
| [1678] | Analog out X45/1 [mA]           |             |
| [1679] | Analog out X45/3 [mA]           |             |
| [1684] | Comm. option STW                |             |
| [1687] | Bus readout alarm/warning       |             |
| [1689] | Configurable alarm/warning word |             |
| [1690] | Alarm word                      |             |
| [1691] | Alarm word 2                    |             |
| [1692] | Warning word                    |             |
| [1693] | Warning word 2                  |             |
| [1694] | Ext. status word                |             |
| [1695] | Ext. status word 2              |             |
| [1696] | Maintenance word                |             |
| [1697] | Alarm word 3                    |             |
| [1698] | Warning word 3                  |             |
| [1804] | Mech brake count                |             |
| [1820] | Commanded position              |             |
| [1821] | Master position                 |             |
| [1823] | Virtual master pos.             |             |
| [1824] | Marker pos. offset              |             |
| [1825] | Latched actual pos.             |             |
| [1826] | Actual velocity [pu/s]          |             |
| [1827] | Safe opt. est. speed            |             |
| [1828] | Safe opt. meas. speed           |             |
| [1829] | Safe opt. speed error           |             |
| [1836] | Analog input X48/2 [mA]         |             |

| Option | Name                      | Description |
|--------|---------------------------|-------------|
| [1837] | Temp. input X48/4         |             |
| [1838] | Temp. input X48/7         |             |
| [1839] | Temp. input X48/10        |             |
| [1840] | Analog input X49/1        |             |
| [1841] | Analog input X49/3        |             |
| [1842] | Analog input X49/5        |             |
| [1843] | Analog input X49/7        |             |
| [1844] | Analog out X49/9          |             |
| [1845] | Analog out X49/11         |             |
| [1846] | X49 digital output [bin]  |             |
| [1860] | Digital input 2           |             |
| [1889] | Mode of operation display |             |
| [1899] | Speed PID torque FF. [Nm] |             |
| [3421] | PCD 1 read from MCO       |             |
| [3422] | PCD 2 read from MCO       |             |
| [3423] | PCD 3 read from MCO       |             |
| [3424] | PCD 4 read from MCO       |             |
| [3425] | PCD 5 read from MCO       |             |
| [3426] | PCD 6 read from MCO       |             |
| [3427] | PCD 7 read from MCO       |             |
| [3428] | PCD 8 read from MCO       |             |
| [3429] | PCD 9 read from MCO       |             |
| [3430] | PCD 10 read from MCO      |             |
| [3440] | Digital inputs            |             |
| [3441] | Digital outputs           |             |
| [3450] | Actual position           |             |
| [3451] | Commanded position        |             |
| [3452] | Actual master position    |             |
| [3453] | Slave index position      |             |
| [3454] | Master index position     |             |
| [3455] | Curve position            |             |
| [3456] | Track error               |             |

| Option | Name                         | Description |
|--------|------------------------------|-------------|
| [3457] | Synchronizing error          |             |
| [3458] | Actual velocity              |             |
| [3459] | Actual master velocity       |             |
| [3460] | Synchronizing status         |             |
| [3461] | Axis status                  |             |
| [3462] | Program status               |             |
| [3464] | MCO 302 status               |             |
| [3465] | MCO 302 control              |             |
| [3466] | SPI error counter            |             |
| [3470] | MCO alarm word 1             |             |
| [3471] | MCO alarm word 2             |             |
| [4029] | B-EMF protection log readout |             |
| [4280] | Safe option status           |             |
| [4285] | Active safe func.            |             |
| [4521] | Status                       |             |
| [4523] | Baseline failure             |             |
| [4590] | Stator [%]                   |             |
| [4591] | Load [%]                     |             |
| [4592] | Sensor 1 [%]                 |             |
| [4593] | Sensor 1 [unit]              |             |
| [4594] | Sensor 2 [%]                 |             |
| [4595] | Sensor 2 [unit]              |             |
| [4596] | Sensor 3 [%]                 |             |
| [4597] | Sensor 3 [unit]              |             |
| [4598] | Sensor 4 [%]                 |             |
| [4599] | Sensor 4 [unit]              |             |

Parameter 12-23 Process Data Config Write Size

Table 623: Parameter 12-23 Process Data Config Write Size

| 12-23 Process Data Config Write Size |                               |                               |
|--------------------------------------|-------------------------------|-------------------------------|
| Default value: 16                    | Parameter type: Range, 8 - 32 | Setup: All setups             |
| Conversion index: 0                  | Data type: Uint32             | Change during operation: True |

Use this parameter to configure the PCD write size in bits. Only values of multiples of 8 are valid.

## Parameter 12-24 Process Data Config Read Size

Table 624: Parameter 12-24 Process Data Config Read Size

| 12-24 Process Data Config Read Size |                               |                               |
|-------------------------------------|-------------------------------|-------------------------------|
| Default value: 16                   | Parameter type: Range, 8 - 32 | Setup: All setups             |
| Conversion index: 0                 | Data type: Uint32             | Change during operation: True |

Use this parameter to configure the PCD read size in bits. Only values of multiples of 8 are valid.

## Parameter 12-27 Master Address

Table 625: Parameter 12-27 Master Address

| 12-27 Master Address |                                       |                                |
|----------------------|---------------------------------------|--------------------------------|
| Default value: 0     | Parameter type: Range, 0 - 4294967295 | Setup: All setups              |
| Conversion index: 0  | Data type: OctetString                | Change during operation: False |

## Parameter 12-28 Store Data Values

Table 626: Parameter 12-28 Store Data Values

| 12-28 Store Data Values |                        |                               |
|-------------------------|------------------------|-------------------------------|
| Default value: [0] Off  | Parameter type: Option | Setup: All setups             |
| Conversion index: –     | Data type: Uint8       | Change during operation: True |

This parameter activates a function that stores all parameter values in the non-volatile memory (EEPROM) thus retaining parameter values at power-down. The parameter returns to [0] Off.

| Option | Name             | Description |
|--------|------------------|-------------|
| [0]*   | Off              |             |
| [1]    | Store all setups |             |
| [2]    | Store all setups |             |

## Parameter 12-29 Store Always

Table 627: Parameter 12-29 Store Always

| 12-29 Store Always     |                        |                               |
|------------------------|------------------------|-------------------------------|
| Default value: [0] Off | Parameter type: Option | Setup: 1 setup                |
| Conversion index: –    | Data type: Uint8       | Change during operation: True |

Activates a function that always stores received parameter data in the non-volatile memory (EEPROM).

| Option | Name | Description |
|--------|------|-------------|
| [0]*   | Off  |             |
| [1]    | On   |             |



## 5.12.4 12-3\* EtherNet/IP

## Parameter 12-30 Warning Parameter

Table 628: Parameter 12-30 Warning Parameter

| 12-30 Warning Parameter |                                       |                               |
|-------------------------|---------------------------------------|-------------------------------|
| Default value: 0        | Parameter type: Range, 0 - 2147483647 | Setup: All setups             |
| Conversion index: 0     | Data type: Uint32                     | Change during operation: True |

This parameter is read-only. It shows the EtherNet/IP-specific 16-bit status word.

Table 629: 16-Bit Status Word, EtherNet/IP

| Bit | Description               |
|-----|---------------------------|
| 0   | Owned                     |
| 1   | Not used                  |
| 2   | Configured                |
| 3   | Not used                  |
| 4   | Not used                  |
| 5   | Not used                  |
| 6   | Not used                  |
| 7   | Not used                  |
| 8   | Minor recoverable fault   |
| 9   | Minor unrecoverable fault |
| 10  | Major recoverable fault   |
| 11  | Major unrecoverable fault |
| 12  | Not used                  |
| 13  | Not used                  |
| 14  | Not used                  |
| 15  | Not used                  |

## Parameter 12-31 Net Reference

Table 630: Parameter 12-31 Net Reference

| 12-31 Net Reference    |                        |                               |
|------------------------|------------------------|-------------------------------|
| Default value: [0] Off | Parameter type: Option | Setup: 2 setups               |
| Conversion index: -    | Data type: Uint8       | Change during operation: True |

Shows the reference source in instance 21/71.

| Option | Name | Description |
|--------|------|-------------|
| [0]*   | Off  |             |
| [1]    | On   |             |

## Parameter 12-32 Net Control

Table 631: Parameter 12-32 Net Control

| 12-32 Net Control      |                        |                               |
|------------------------|------------------------|-------------------------------|
| Default value: [0] Off | Parameter type: Option | Setup: 2 setups               |
| Conversion index: –    | Data type: Uint8       | Change during operation: True |

Shows the control source in instance 21/71.

| Option | Name | Description |
|--------|------|-------------|
| [0]*   | Off  |             |
| [1]    | On   |             |

## Parameter 12-33 CIP Revision

Table 632: Parameter 12-33 CIP Revision

| 12-33 CIP Revision          |                                  |                               |
|-----------------------------|----------------------------------|-------------------------------|
| Default value: Size related | Parameter type: Range, 0 - 65535 | Setup: 1 setup                |
| Conversion index: 0         | Data type: Uint16                | Change during operation: True |

This parameter is read-only. It shows the CIP version of the option software.

## Parameter 12-34 CIP Product Code

Table 633: Parameter 12-34 CIP Product Code

| 12-34 CIP Product Code      |                                  |                               |
|-----------------------------|----------------------------------|-------------------------------|
| Default value: Size related | Parameter type: Range, 0 - 65535 | Setup: 1 setup                |
| Conversion index: 0         | Data type: Uint16                | Change during operation: True |

This parameter is read-only. It shows the CIP product code.

## Parameter 12-35 EDS Parameter

Table 634: Parameter 12-35 EDS Parameter

| 12-35 EDS Parameter |                              |                          |
|---------------------|------------------------------|--------------------------|
| Default value: 0    | Parameter type: Range, 0 - 0 | Setup: All setups        |
| Conversion index: 0 | Data type: Uint32            | Change during operation: |

This parameter is used to configure the drive via DeviceNet and build the EDS-file.

## Parameter 12-37 COS Inhibit Timer

Table 635: Parameter 12-37 COS Inhibit Timer

| 12-37 COS Inhibit Timer |                                  |                               |
|-------------------------|----------------------------------|-------------------------------|
| Default value: 0        | Parameter type: Range, 0 - 65535 | Setup: All setups             |
| Conversion index: 0     | Data type: Uint16                | Change during operation: True |

Read-only change-of-state inhibit timer. If the option is configured for COS operation, this inhibit timer can be configured in the forward open telegram to prevent that continuously changing PCD data generates extensive network traffic. The inhibit time is in ms. 0 = disabled.

## Parameter 12-38 COS Filter

Table 636: Parameter 12-38 COS Filter

| 12-38 COS Filter    |                                  |                               |
|---------------------|----------------------------------|-------------------------------|
| Default value: 0    | Parameter type: Range, 0 - 65535 | Setup: All setups             |
| Conversion index: 0 | Data type: Uint16                | Change during operation: True |

Change-of-state PCD filters. Sets up a filter mask for each word of process data when operating in COS mode. Single bits in the PCDs can be filtered in/out.

## 5.12.5 12-4\* Modbus TCP

## Parameter 12-40 Status Parameter

Table 637: Parameter 12-40 Status Parameter

| 12-40 Status Parameter |                              |                               |
|------------------------|------------------------------|-------------------------------|
| Default value: 0       | Parameter type: Range, 0 - 0 | Setup: All setups             |
| Conversion index: 0    | Data type: Uint16            | Change during operation: True |

This parameter is read-only. It shows the Modbus TCP-specific 16-bit status word.

Table 638: 16-Bit Status Word, Modbus TCP

| Bit | Description            | Bit = [0]    | Bit = [1] |
|-----|------------------------|--------------|-----------|
| 0   | Link status port 1     | Disconnected | Connected |
| 1   | Link status port 2     | Disconnected | Connected |
| 2   | Link speed             | 0/10 Mbps    | 100 Mbps  |
| 3   | Link duplex            | Half         | Full      |
| 4   | Port 502 communication | No           | Yes       |
| 5   | UNUSED                 | –            | –         |
| 6   | Valid IP address       | No           | Yes       |
| 7   | Modbus timeout (30 s)  | No           | Yes       |
| 8   | Duplicate IP           | No           | Yes       |
| 9   | Register 7 error       | No           | Yes       |
| 10  | FTP server             | Disabled     | Enabled   |
| 11  | HTTP server            | Disabled     | Enabled   |
| 12  | SMTP server            | Disabled     | Enabled   |
| 13  | Cable diagnosis        | Disabled     | Enabled   |
| 14  | Auto crossover         | Disabled     | Enabled   |
| 15  | IPMG                   | Disabled     | Enabled   |

## Parameter 12-41 Slave Message Count

Table 639: Parameter 12-41 Slave Message Count

| 12-41 Slave Message Count |                              |                               |
|---------------------------|------------------------------|-------------------------------|
| Default value: 0          | Parameter type: Range, 0 - 0 | Setup: All setups             |
| Conversion index: 0       | Data type: Uint32            | Change during operation: True |

This parameter is read-only. It shows the number of Modbus messages received and processed by the follower drive.

## Parameter 12-42 Slave Exception Message Count

Table 640: Parameter 12-42 Slave Exception Message Count

| 12-42 Slave Exception Message Count |                              |                               |
|-------------------------------------|------------------------------|-------------------------------|
| Default value: 0                    | Parameter type: Range, 0 - 0 | Setup: All setups             |
| Conversion index: 0                 | Data type: Uint32            | Change during operation: True |

This parameter is read-only. It shows the number of Modbus messages for which the follower has sent an exception response.

## 5.12.6 12-4\* Fieldbus Extension

## Parameter 12-49 Ethernet Extended Status

Table 641: Parameter 12-49 Ethernet Extended Status

| 12-49 Ethernet Extended Status |                                       |                               |
|--------------------------------|---------------------------------------|-------------------------------|
| Default value: 0               | Parameter type: Range, 0 - 0xFFFFFFFF | Setup: All setups             |
| Conversion index: 0            | Data type: Uint32                     | Change during operation: True |

## 5.12.7 12-5\* EtherCAT

## Parameter 12-50 Configured Station Alias

Table 642: Parameter 12-50 Configured Station Alias

| 12-50 Configured Station Alias |                                  |                                |
|--------------------------------|----------------------------------|--------------------------------|
| Default value: 0               | Parameter type: Range, 0 - 65535 | Setup: 1 setup                 |
| Conversion index: 0            | Data type: Uint16                | Change during operation: False |

Changes are first active after a power cycle. If the DIP switches are all set to ON or all to OFF, the display setting has priority over the DIP switch. Otherwise, the DIP switch settings have priority over the parameter. In this case, the parameter reflects the setting of the DIP switches. Changes to the DIP switch setting are active after a power-up.

## Parameter 12-51 Configured Station Address

Table 643: Parameter 12-51 Configured Station Address

| 12-51 Configured Station Address |                                  |                               |
|----------------------------------|----------------------------------|-------------------------------|
| Default value: 0                 | Parameter type: Range, 0 - 65535 | Setup: All setups             |
| Conversion index: 0              | Data type: Uint16                | Change during operation: True |

This parameter shows the configured station address. The parameter can only be set by the master at power-up.

## Parameter 12-59 EtherCAT Status

Table 644: Parameter 12-59 EtherCAT Status

| 12-59 EtherCAT Status |                                       |                               |
|-----------------------|---------------------------------------|-------------------------------|
| Default value: 0      | Parameter type: Range, 0 - 4294967295 | Setup:All setups              |
| Conversion index: 0   | Data type: Uint32                     | Change during operation: True |

This parameter contains status information on the EtherCAT interface. Each of the 32 bits is linked to a status information of the EtherCAT interface.

- Bits 0–7 contain information from ESC register 0x0130 (AL status).
- Bits 8–15 are reserved for future use.
- Bits 16–27 contain information from the ESC register 0x0110 and 0x0111 (DL status).
- Bits 28–31 are reserved for future use.

Table 645: Bit Interpretation

| Bit | Description                 | Bit = [0]                              | Bit = [1]                                |
|-----|-----------------------------|--|--|
| 0   | EtherCAT statemachine state | –                                      | Init State                               |
| 1   | EtherCAT statemachine state | –                                      | Pre-OP                                   |
| 2   | EtherCAT statemachine state | –                                      | Safe-OP                                  |
| 3   | EtherCAT statemachine state | –                                      | Reserved                                 |
| 4   | Reserved                    | –                                      | –  |
| 5   | Reserved                    | –                                      | –  |
| 6   | Reserved                    | –                                      | –  |
| 7   | Reserved                    | –                                      | –  |
| 8   | Reserved                    | –                                      | –  |
| 9   | Reserved                    | –                                      | –  |
| 10  | Reserved                    | –                                      | –  |
| 11  | Reserved                    | –                                      | –  |
| 12  | Reserved                    | –                                      | –  |
| 13  | Reserved                    | –                                      | –  |
| 14  | Reserved                    | –                                      | –  |
| 15  | Reserved                    | –                                      | –  |
| 16  | PDI operational             | EEPROM not loaded, PDI not operational | EEPROM loaded correctly, PDI operational |
| 17  | PDI watchdog status         | Watchdog expired                       | Watchdog reloaded                        |
| 18  | Enhanced link detection     | Deactivated for all ports              | Activated for all ports                  |
| 19  | –                           | –                                      | Reserved                                 |
| 20  | Physical link on port 0     | No link                                | Link detected                            |
| 21  | Physical link on port 1     | No link                                | Link detected                            |

| Bit | Description             | Bit = [0]               | Bit = [1]                 |
|-----|-------------------------|-------------------------|---------------------------|
| 22  | Reserved                | –                       | –                         |
| 23  | Reserved                | –                       | –                         |
| 24  | Loop port 0             | Open                    | Closed                    |
| 25  | Communication on port 0 | No stable communication | Communication established |
| 26  | Loop port 1             | Open                    | Closed                    |
| 27  | Communication on port 1 | No stable communication | Communication established |
| 28  | Reserved                | –                       | –                         |
| 29  | Reserved                | –                       | –                         |
| 30  | Reserved                | –                       | –                         |
| 31  | Reserved                | –                       | –                         |

### 5.12.8 12-6\* Ethernet POWERLINK

#### Parameter 12-60 Node ID

Table 646: Parameter 12-60 Node ID

| 12-60 Node ID       |                                |                               |
|---------------------|--------------------------------|-------------------------------|
| Default value: 1    | Parameter type: Range, 1 - 239 | Setup: 2 setups               |
| Conversion index: 0 | Data type: Uint8               | Change during operation: True |

Enter the node ID in this parameter or alternatively in the hardware switch. To adjust the node ID in this parameter, set the hardware switch to 0 or to 255 (all switches set to [ON] or to [OFF]). Otherwise, this parameter shows the actual setting of the switch. The settings of this parameter take effect at the next power-up cycle.

Table 647: Parameter 12-62 SDO Timeout

| 12-62 SDO Timeout    |                                       |                               |
|----------------------|---------------------------------------|-------------------------------|
| Default value: 15000 | Parameter type: Range, 0 - 2000000000 | Setup: All setups             |
| Conversion index: -3 | Data type: Uint32                     | Change during operation: True |

This parameter is the SDO Timeout in ms. The value of this parameter is read during communication initialization into Object 1300h.

#### Parameter 12-63 Basic Ethernet Timeout

Table 648: Parameter 12-63 Basic Ethernet Timeout

| 12-63 Basic Ethernet Timeout |   |                               |
|------------------------------|---|-------------------------------|
| Default value: 5000.000      | Parameter type: Range, 0 - 2000000.000 ms | Setup: All setups             |
| Conversion index: -3         | Data type: Uint32                         | Change during operation: True |

This parameter is the basic Ethernet timeout in ms. This parameter is mapped to Object 1F99h. If the POWERLINK interface does not receive a SoC frame within the specified time, the interface shifts to standard Ethernet mode. This feature is available from version 2.00 of the POWERLINK interface.

## Parameter 12-66 Threshold

Table 649: Parameter 12-66 Threshold

| 12-66 Threshold     |                                       |                               |
|---------------------|---------------------------------------|-------------------------------|
| Default value: 15   | Parameter type: Range, 0 - 2000000000 | Setup: All setups             |
| Conversion index: 0 | Data type: Uint32                     | Change during operation: True |

This parameter holds 6 threshold values. If 1 of these thresholds are exceeded, the POWERLINK interface exits operational mode. The parameters are set to optimal settings and should not be changed. The actual value of the counters can be read out via *parameter 12-67 Threshold Counters*.

## Parameter 12-67 Threshold Counters

Table 650: Parameter 12-67 Threshold Counters

| 12-67 Threshold Counters |                                       |                               |
|--------------------------|---------------------------------------|-------------------------------|
| Default value: 0         | Parameter type: Range, 0 - 4294967295 | Setup: All setups             |
| Conversion index: 0      | Data type: Uint32                     | Change during operation: True |

This parameter holds 6 counters. The counter reflects the actual value in the POWERLINK interface. Counters increase with a count of 8 at detection of an error and decrease with a count of 1 when no errors are detected. The values are read-only.

## Parameter 12-68 Cumulative Counters

Table 651: Parameter 12-68 Cumulative Counters

| 12-68 Cumulative Counters |                                       |                               |
|---------------------------|---------------------------------------|-------------------------------|
| Default value: 0          | Parameter type: Range, 0 - 2147483647 | Setup: All setups             |
| Conversion index: 0       | Data type: Uint32                     | Change during operation: True |

Loss of SoC Cumulative. This parameter reflects the value in object 1C0Bh, sub-index 1.

## Parameter 12-69 Ethernet POWERLINK Status

Table 652: Parameter 12-69 Ethernet POWERLINK Status

| 12-69 Ethernet POWERLINK Status |                                       |                               |
|---------------------------------|---------------------------------------|-------------------------------|
| Default value: 0                | Parameter type: Range, 0 - 4294967295 | Setup: All setups             |
| Conversion index: 0             | Data type: Uint32                     | Change during operation: True |

This parameter shows various status and error conditions for the Ethernet POWERLINK connection.

## 5.12.9 12-8\* Other Ethernet Services

## Parameter 12-80 FTP Server

Table 653: Parameter 12-80 FTP Server

| 12-80 FTP Server            |                        |                               |
|-----------------------------|------------------------|-------------------------------|
| Default value: [0] Disabled | Parameter type: Option | Setup: 2 setups               |
| Conversion index: -         | Data type: Uint8       | Change during operation: True |

Enables/disables the built-in FTP server.

| Option | Name     | Description |
|--------|----------|-------------|
| [0]*   | Disabled |             |
| [1]    | Enabled  |             |

## Parameter 12-81 HTTP Server

Table 654: Parameter 12-81 HTTP Server

| 12-81 HTTP Server           |                        |                               |
|-----------------------------|------------------------|-------------------------------|
| Default value: [0] Disabled | Parameter type: Option | Setup: 2 setups               |
| Conversion index: –         | Data type: Uint8       | Change during operation: True |

Enables/disables the built-in HTTP (web) server.

| Option | Name     | Description |
|--------|----------|-------------|
| [0]*   | Disabled |             |
| [1]    | Enabled  |             |

## Parameter 12-82 SMTP Service

Table 655: Parameter 12-82 SMTP Service

| 12-82 SMTP Service          |                        |                               |
|-----------------------------|------------------------|-------------------------------|
| Default value: [0] Disabled | Parameter type: Option | Setup: 2 setups               |
| Conversion index: –         | Data type: Uint8       | Change during operation: True |

Enables/disables the built-in SMTP (e-mail) service on the option.

| Option | Name     | Description |
|--------|----------|-------------|
| [0]*   | Disabled |             |
| [1]    | Enabled  |             |

## Parameter 12-83 SNMP Agent

Table 656: Parameter 12-83 SNMP Agent

| 12-83 SNMP Agent           |                        |                               |
|----------------------------|------------------------|-------------------------------|
| Default value: [1] Enabled | Parameter type: Option | Setup: 2 setups               |
| Conversion index: –        | Data type: Uint8       | Change during operation: True |

Use this parameter to either enable or disable the SNMP agent.

| Option | Name     | Description |
|--------|----------|-------------|
| [0]    | Disabled |             |
| [1]*   | Enabled  |             |

## Parameter 12-84 Address Conflict Detection

Table 657: Parameter 12-84 Address Conflict Detection

| 12-84 Address Conflict Detection |                        |                               |
|----------------------------------|------------------------|-------------------------------|
| Default value: [1] Enabled       | Parameter type: Option | Setup: 2 setups               |
| Conversion index: –              | Data type: Uint8       | Change during operation: True |

Use this parameter to detect and resolve IP address conflict.



| Option | Name     | Description |
|--------|----------|-------------|
| [0]    | Disabled |             |
| [1]*   | Enabled  |             |

Table 658: Parameter 12-85 ACD Last Conflict

| 12-85 ACD Last Conflict |                                       |                               |
|-------------------------|---------------------------------------|-------------------------------|
| Default value: 0        | Parameter type: Range, 0 - 2147483647 | Setup: 2 setups               |
| Conversion index: 0     | Data type: OctetString                | Change during operation: True |

The name of the IP address causing the most recent address conflict.  
Parameter 12-89 Transparent Socket Channel Port

Table 659: Parameter 12-89 Transparent Socket Channel Port

| 12-89 Transparent Socket Channel Port |                                     |                               |
|---------------------------------------|-------------------------------------|-------------------------------|
| Default value: Size related           | Parameter type: Range, size related | Setup: 2 setups               |
| Conversion index: 0                   | Data type: Uint16                   | Change during operation: True |

Configures the TCP port number for the transient socket channel. This enables FC telegrams to be sent transiently on Ethernet via TCP. The default value of 4000.0 indicates disabled.

### 5.12.10 12-9\* Advanced Ethernet Services

#### Parameter 12-90 Cable Diagnostic

Table 660: Parameter 12-90 Cable Diagnostic

| 12-90 Cable Diagnostic      |                        |                               |
|-----------------------------|------------------------|-------------------------------|
| Default value: [0] Disabled | Parameter type: Option | Setup: 2 setups               |
| Conversion index: –         | Data type: Uint8       | Change during operation: True |

Enables/disables advanced cable diagnosis function. If enabled, the distance to cable errors can be read out in *parameter 12-93 Cable Error Length*. The parameter resumes to the default setting [0] *Disable* after the diagnostics have finished.

## N O T I C E

The cable diagnostics function is only issued on ports where there is no link (see *parameter 12-10 Link Status*).

| Option | Name     | Description |
|--------|----------|-------------|
| [0]*   | Disabled |             |
| [1]    | Enabled  |             |

#### 12-91 Auto Cross Over

Table 661: Parameter 12-91 Auto Cross Over

| 12-91 Auto Cross Over      |                        |                               |
|----------------------------|------------------------|-------------------------------|
| Default value: [1] Enabled | Parameter type: Option | Setup: 2 setups               |
| Conversion index: –        | Data type: Uint8       | Change during operation: True |

## N O T I C E

Disabling of the auto-crossover function requires crossed Ethernet cables for daisy-chaining the options.

| Option | Name     | Description |
|--------|----------|-------------|
| [0]    | Disabled |             |
| [1]*   | Enabled  |             |

### Parameter 12-92 IGMP Snooping

Table 662: Parameter 12-92 IGMP Snooping

| 12-92 IGMP Snooping        |                        |                               |
|----------------------------|------------------------|-------------------------------|
| Default value: [1] Enabled | Parameter type: Option | Setup: 2 setups               |
| Conversion index: –        | Data type: Uint8       | Change during operation: True |

This function presents flooding of the Ethernet protocol stack by only forwarding multicast packets to ports that are a member of the multicast group.

| Option | Name     | Description |
|--------|----------|-------------|
| [0]    | Disabled |             |
| [1]*   | Enabled  |             |

### Parameter 12-93 Cable Error Length

Table 663: Parameter 12-93 Cable Error Length

| 12-93 Cable Error Length |                                  |                               |
|--------------------------|----------------------------------|-------------------------------|
| Default value: 0         | Parameter type: Range, 0 - 65535 | Setup: All setups             |
| Conversion index: 0      | Data type: Uint16                | Change during operation: True |

If cable diagnostics is enabled in *parameter 12-90 Cable Diagnostic*, the built-in switch is possible via time domain reflectometry (TDR). This is a measurement technique which detects common cabling problems such as open circuits, short circuits, and impedance mismatches or breaks in transmission cables. The distance from the option to the error is shown in meters with an accuracy of  $\pm 2$  m (6.6 ft). The value 0 means no errors detected.

### Parameter 12-94 Broadcast Storm Protection

Table 664: Parameter 12-94 Broadcast Storm Protection

| 12-94 Broadcast Storm Protection |                                 |                               |
|----------------------------------|---------------------------------|-------------------------------|
| Default value: -1                | Parameter type: Range, -1 - 20% | Setup: 2 setups               |
| Conversion index: 0              | Data type: Int8                 | Change during operation: True |

The built-in switch is capable of protecting the switch system from receiving too many broadcast packages, which can use up network resources. The value indicates a percentage of the total bandwidth that is allowed for broadcast messages. Example: OFF means that the filter is disabled - all broadcast messages are passed through. The value 0% means that no broadcast messages are passed through. A value of 10% means that 10% of the total bandwidth is allowed for broadcast messages. If the amount of broadcast messages exceeds the 10% threshold, they are blocked.

## Parameter 12-95 Inactivity Timeout

Table 665: Parameter 12-95 Inactivity Timeout

| 12-95 Inactivity Timeout |                                 |                               |
|--------------------------|---------------------------------|-------------------------------|
| Default value: 120       | Parameter type: Range, 0 - 3600 | Setup: 2 setups               |
| Conversion index: 0      | Data type: Uint16               | Change during operation: True |

Applies to *parameter 12-94 Broadcast Storm Protection*, if the broadcast storm protection also includes multicast telegrams.

## Parameter 12-96 Port Config

Table 666: Parameter 12-96 Port Config

| 12-96 Port Config           |                        |                               |
|-----------------------------|------------------------|-------------------------------|
| Default value: Size related | Parameter type: Option | Setup: 2 setups               |
| Conversion index: –         | Data type: Uint8       | Change during operation: True |

Enable or disable the port-mirroring function. The function is used for troubleshooting with a network analyzer tool.

| Option | Name                  | Description |
|--------|-----------------------|-------------|
| [0]    | Normal                |             |
| [1]    | Mirror port 1 to 2    |             |
| [2]    | Mirror port 2 to 1    |             |
| [10]   | Port 1 disabled       |             |
| [11]   | Port 2 disabled       |             |
| [254]  | Mirror int. port to 1 |             |
| [255]  | Mirror int. port to 2 |             |

## Parameter 12-97 QoS Priority

Table 667: Parameter 12-97 QoS Priority

| 12-97 QoS Priority          |                               |                               |
|-----------------------------|-------------------------------|-------------------------------|
| Default value: Size related | Parameter type: Range, 0 - 63 | Setup: All setups             |
| Conversion index: 0         | Data type: Int8               | Change during operation: True |

Each index sets the DSCP value of different types of QoS prioritized messages.

## Parameter 12-98 Interface Counters

Table 668: Parameter 12-98 Interface Counters

| 12-98 Interface Counters |                                       |                               |
|--------------------------|---------------------------------------|-------------------------------|
| Default value: 4000      | Parameter type: Range, 0 - 4294967295 | Setup: All setups             |
| Conversion index: 0      | Data type: Uint32                     | Change during operation: True |

This parameter is read-only. Advanced interface counters from a built-in switch can be used for low-level troubleshooting. The parameter shows a sum of port 1 + port 2.

Parameter 12-99 Media Counters

Table 669: Parameter 12-99 Media Counters

| 12-99 Media Counters |                                       |                               |
|----------------------|---------------------------------------|-------------------------------|
| Default value: 0     | Parameter type: Range, 0 - 4294967295 | Setup: All setups             |
| Conversion index: 0  | Data type: Uint32                     | Change during operation: True |

This parameter is read-only. Advanced interface counters from a built-in switch can be used for low-level troubleshooting. The parameter shows a sum of port 1 + port 2.

### 5.13 Parameter Group 13-\*\* Smart Logic Control

Smart logic control (SLC) is a sequence of user-defined actions (see *parameter 13-52 SL Controller 1 Action*) executed by the SLC when the associated user-defined event (see *parameter 13-51 SL Controller 1 Event*) is evaluated as true by the SLC. The condition for an event can be a particular status, or that the output from a logic rule or a comparator operand becomes true. That leads to an associated action as illustrated:

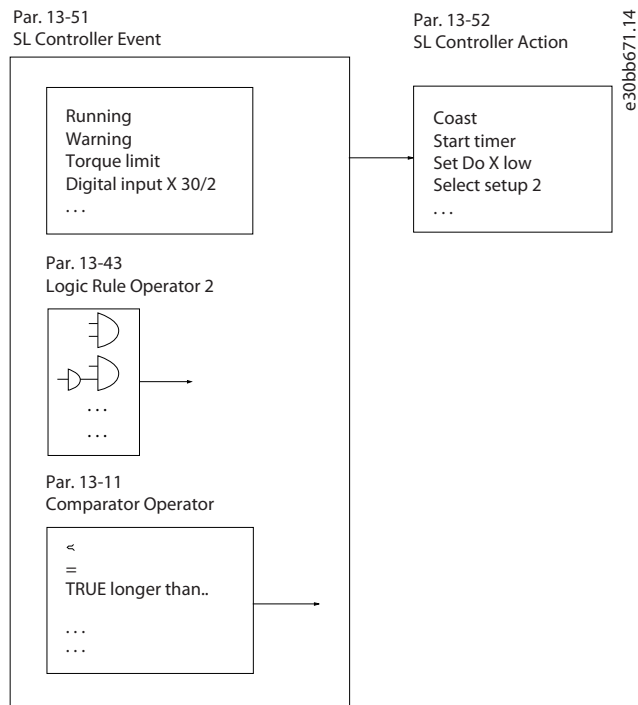

Illustration 77: Smart Logic Control (SLC)

Events and actions are each numbered and linked in pairs (states). This means that when the 1<sup>st</sup> event is fulfilled (becomes true), the 1<sup>st</sup> action is executed. After this, the conditions of the 2<sup>nd</sup> event are evaluated and if evaluated true, the 2<sup>nd</sup> action is executed, and so on. Only 1 event is evaluated at any time. If an event is evaluated as false, nothing happens (in the SLC) during the current scan interval and no other events are evaluated. This means that when the SLC starts, it evaluates the 1<sup>st</sup> event (and only the 1<sup>st</sup> event) in each scan interval. Only when the 1<sup>st</sup> event is evaluated as true, the SLC executes the 1<sup>st</sup> action and starts evaluating the 2<sup>nd</sup> event. It is possible to program 1–20 events and actions. When the last event/action has been executed, the sequence starts over again from the 1<sup>st</sup> event/action.

Four concurring sequences can be defined with each up to 20 event and action pairs. The sequences are executed at the same time but operate separately. For example, sequence 1 may have executed 3 actions, while sequence 2 still waits for its 1<sup>st</sup> event to occur. In this example, *parameter 13-00 SL Controller Mode [0]*, *parameter 13-01 Start Event [1]*, and *parameter 13-02 Stop Event [2]* correspond to sequence 1, sequence 2, sequence 3, and the like.

## NOTICE

Comparators Flip-Flops, timers, and logic rules are shared between sequences.

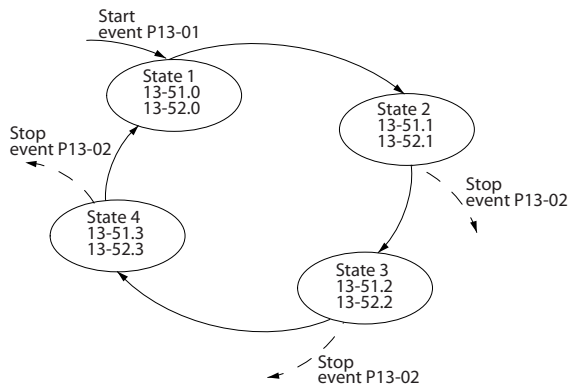

e30ba062.15

Illustration 78: Example of Events and Actions

Starting and stopping the SLC

Start and stop the SLC by selecting [1] On or [0] Off in parameter 13-00 SL Controller Mode. The SLC always starts in state 0 (where it evaluates event [0]). The SLC starts when the start event (defined in parameter 13-01 Start Event) is evaluated as true (provided that [1] On is selected in parameter 13-00 SL Controller Mode). The SLC stops when the stop event (parameter 13-02 Stop Event) is true. Parameter 13-03 Reset SLC resets all SLC parameters and starts programming from scratch.

**NOTICE**

SLC is only active in auto-on mode, not hand-on mode.

5.13.1 13-0\* SLC Settings

Use the SLC settings to activate, deactivate, and reset the smart logic control sequence. The logic functions and comparators are always running in the background, which opens for separate control of digital inputs and outputs.

Parameter 13-00 SL Controller Mode

Table 670: Parameter 13-00 SL Controller Mode

| 13-00 SL Controller Mode    |                                   |                               |
|-----------------------------|-----------------------------------|-------------------------------|
| Default value: Size related | Parameter type: Option, Array [4] | Setup: 2 setups               |
| Conversion index: -         | Data type: Uint8                  | Change during operation: True |

An array with 4 elements [0]–[3] is shown in the display.

| Option | Name | Description                          |
|--------|------|--------------------------------------|
| [0]    | Off  | Disables the smart logic controller. |
| [1]    | On   | Enables the smart logic controller.  |

Parameter 13-01 Start Event

Table 671: Parameter 13-01 Start Event

| 13-01 Start Event           |                                   |                               |
|-----------------------------|-----------------------------------|-------------------------------|
| Default value: Size related | Parameter type: Option, Array [4] | Setup: 2 setups               |
| Conversion index: -         | Data type: Uint8                  | Change during operation: True |

Select the boolean (true or false) input to activate smart logic control.

| Option | Name                 | Description  |
|--------|----------------------|--|
| [0]    | False                | Select the boolean (true or false) input to activate smart logic control. Enters the fixed value <i>False</i> .  |
| [1]    | True                 | Enters the fixed value <i>True</i> .   |
| [2]    | Running              | The motor runs.  |
| [3]    | In range             | The motor runs within the programmed current and speed ranges set in <i>parameter 4-50 Warning Current Low</i> to <i>parameter 4-53 Warning Speed High</i> . |
| [4]    | On reference         | The motor runs on reference.   |
| [5]    | Torque limit         | The torque limit set in <i>parameter 4-16 Torque Limit Motor Mode</i> or <i>parameter 4-17 Torque Limit Generator Mode</i> is exceeded.                      |
| [6]    | Current limit        | The motor current limit set in <i>parameter 4-18 Current Limit</i> is exceeded.  |
| [7]    | Out of current range | The motor current is outside the range set in <i>parameter 4-18 Current Limit</i> .  |
| [8]    | Below $I_{low}$      | The motor current is lower than set in <i>parameter 4-50 Warning Current Low</i> .   |
| [9]    | Above $I_{high}$     | The motor current is higher than set in <i>parameter 4-51 Warning Current High</i> .   |
| [10]   | Out of speed range   | The speed is outside the range set in <i>parameter 4-52 Warning Speed Low</i> and <i>parameter 4-53 Warning Speed High</i> .                                 |
| [11]   | Below speed low      | The output speed is lower than the setting in <i>parameter 4-52 Warning Speed Low</i> .  |
| [12]   | Above speed high     | The output speed is higher than the setting in <i>parameter 4-53 Warning Speed High</i> .  |
| [13]   | Out of feedb. range  | The feedback is outside the range set in <i>parameter 4-56 Warning Feedback Low</i> and <i>parameter 4-57 Warning Feedback High</i> .                        |
| [14]   | Below feedb. low     | The feedback is below the limit set in <i>parameter 4-56 Warning Feedback Low</i> .  |
| [15]   | Above feedb. high    | The feedback is above the limit set in <i>parameter 4-57 Warning Feedback High</i> .   |
| [16]   | Thermal warning      | The thermal warning turns on when the temperature exceeds the limit in the motor, the drive, the brake resistor, or the thermistor.                          |
| [17]   | Mains out of range   | The mains voltage is outside the specified voltage range.  |
| [18]   | Reversing            | The output is high when the drive is running counterclockwise (the logical product of the status bits running AND reverse).                                  |
| [19]   | Warning              | A warning is active.   |
| [20]   | Alarm (trip)         | A (trip) alarm is active.  |
| [21]   | Alarm (trip lock)    | A (trip lock) alarm is active.   |
| [22]   | Comparator 0         | Use the result of comparator 0.  |
| [23]   | Comparator 1         | Use the result of comparator 1.  |
| [24]   | Comparator 2         | Use the result of comparator 2.  |
| [25]   | Comparator 3         | Use the result of comparator 3.  |
| [26]   | Logic rule 0         | Use the result of logic rule 0.  |
| [27]   | Logic rule 1         | Use the result of logic rule 1.  |

| Option | Name                | Description   |
|--------|---------------------|---|
| [28]   | Logic rule 2        | Use the result of logic rule 2.   |
| [29]   | Logic rule 3        | Use the result of logic rule 3.   |
| [33]   | Digital input DI18  | Use the result of digital input 18.   |
| [34]   | Digital input DI19  | Use the result of digital input 19.   |
| [35]   | Digital input DI27  | Use the result of digital input 27.   |
| [36]   | Digital input DI29  | <div style="text-align: center; background-color: #cccccc; padding: 5px;"><b>NOTICE</b></div> <div style="border: 1px solid black; padding: 5px; margin: 5px 0;">This option is only available in FC 302.</div> Use the result of digital input 29. |
| [37]   | Digital input DI32  | Use the result of digital input 32.   |
| [38]   | Digital input DI33  | Use the result of digital input 33.   |
| [39]   | Start command       | A start command is issued. This is the default option.  |
| [40]   | Drive stopped       | A stop command (jog, stop, quick stop, coast) is issued - and not from SLC itself.  |
| [41]   | Reset trip          | A reset is issued.  |
| [42]   | Auto-reset trip     | An auto reset is performed.   |
| [43]   | OK key              | [OK] is pressed. Only available on the graphical LCP.   |
| [44]   | Reset key           | [Reset] is pressed. Only available on the graphical LCP.  |
| [45]   | Left key            | [◀] is pressed. Only available on the graphical LCP.  |
| [46]   | Right key           | [▶] is pressed. Only available on the graphical LCP.  |
| [47]   | Up key              | [▲] is pressed. Only available on the graphical LCP.  |
| [48]   | Down key            | [▼] is pressed. Only available on the graphical LCP.  |
| [50]   | Comparator 4        | Use the result of comparator 4.   |
| [51]   | Comparator 5        | Use the result of comparator 5.   |
| [60]   | Logic rule 4        | Use the result of logic rule 4.   |
| [61]   | Logic rule 5        | Use the result of logic rule 5.   |
| [76]   | Digital input X30/2 | Use the value of X30/2 (VLT® General Purpose I/O MCB 101).  |
| [77]   | Digital input X30/3 | Use the value of X30/3 (VLT® General Purpose I/O MCB 101).  |
| [78]   | Digital input X30/4 | Use the value of X30/4 (VLT® General Purpose I/O MCB 101).  |
| [79]   | Digital input X46/1 | Use the value of X46/1 (VLT® Extended Relay Card MCB 113).  |
| [80]   | Digital input X46/3 | Use the value of X46/3 (VLT® Extended Relay Card MCB 113).  |
| [81]   | Digital input X46/5 | Use the value of X46/5 (VLT® Extended Relay Card MCB 113).  |
| [82]   | Digital input X46/7 | Use the value of X46/7 (VLT® Extended Relay Card MCB 113).  |
| [83]   | Digital input X46/9 | Use the value of X46/9 (VLT® Extended Relay Card MCB 113).  |

| Option | Name                 | Description   |
|--------|----------------------|---|
| [84]   | Digital input X46/11 | Use the value of X46/11 (VLT® Extended Relay Card MCB 113). |
| [85]   | Digital input X46/13 | Use the value of X46/13 (VLT® Extended Relay Card MCB 113). |
| [94]   | RS Flipflop 0        | See <i>parameter group 13-1* Comparators</i> .              |
| [95]   | RS Flipflop 1        | See <i>parameter group 13-1* Comparators</i> .              |
| [96]   | RS Flipflop 2        | See <i>parameter group 13-1* Comparators</i> .              |
| [97]   | RS Flipflop 3        | See <i>parameter group 13-1* Comparators</i> .              |
| [98]   | RS Flipflop 4        | See <i>parameter group 13-1* Comparators</i> .              |
| [99]   | RS Flipflop 5        | See <i>parameter group 13-1* Comparators</i> .              |
| [100]  | RS Flipflop 6        | See <i>parameter group 13-1* Comparators</i> .              |
| [101]  | RS Flipflop 7        | See <i>parameter group 13-1* Comparators</i> .              |
| [212]  | Emergency mode       |   |
| [222]  | Homing OK            |   |
| [223]  | On target            |   |
| [224]  | Position error       |   |
| [225]  | Position limit       |   |
| [226]  | Touch on target      |   |
| [227]  | Touch activated.     |   |
| [228]  | Comparator 6         | Use the result of comparator 6.                             |
| [229]  | Comparator 7         | Use the result of comparator 7.                             |
| [230]  | Comparator 8         | Use the result of comparator 8.                             |
| [231]  | Comparator 9         | Use the result of comparator 9.                             |
| [232]  | Logic rule 6         | Use the result of logic rule 6.                             |
| [233]  | Logic rule 7         | Use the result of logic rule 7.                             |
| [234]  | Logic rule 8         | Use the result of logic rule 8.                             |
| [235]  | Logic rule 9         | Use the result of logic rule 9.                             |
| [238]  | RS flipflop 8        | See <i>parameter group 13-1* Comparators</i> .              |
| [239]  | RS flipflop 9        | See <i>parameter group 13-1* Comparators</i> .              |

## Parameter 13-02 Stop Event

Table 672: Parameter 13-02 Stop Event

| 13-02 Stop Event            |                                   |                               |
|-----------------------------|-----------------------------------|-------------------------------|
| Default value: Size related | Parameter type: Option, Array [4] | Setup: 2 setups               |
| Conversion index: -         | Data type: Uint8                  | Change during operation: True |



Select the boolean (true or false) input to deactivate smart logic control.

| Option | Name                 | Description   |
|--------|----------------------|---|
| [0]    | False                | For descriptions of options [0] False–[61] Logic rule 5, see parameter 13-01 Start Event. |
| [1]    | True                 |   |
| [2]    | Running              |   |
| [3]    | In range             |   |
| [4]    | On reference         |   |
| [5]    | Torque limit         |   |
| [6]    | Current limit        |   |
| [7]    | Out of current range |   |
| [8]    | Below $I_{low}$      |   |
| [9]    | Above $I_{high}$     |   |
| [10]   | Out of speed range   |   |
| [11]   | Below speed low      |   |
| [12]   | Above speed high     |   |
| [13]   | Out of feedb. range  |   |
| [14]   | Below feedb. low     |   |
| [15]   | Above feedb. high    |   |
| [16]   | Thermal warning      |   |
| [17]   | Mains out of range   |   |
| [18]   | Reversing            |   |
| [19]   | Warning              |   |
| [20]   | Alarm (trip)         |   |
| [21]   | Alarm (trip lock)    |   |
| [22]   | Comparator 0         |   |
| [23]   | Comparator 1         |   |
| [24]   | Comparator 2         |   |
| [25]   | Comparator 3         |   |
| [26]   | Logic rule 0         |   |
| [27]   | Logic rule 1         |   |
| [28]   | Logic rule 2         |   |
| [29]   | Logic rule 3         |   |
| [30]   | SL time-out 0        |   |
| [31]   | SL time-out 1        |   |

| Option | Name                | Description   |
|--------|---------------------|---|
| [32]   | SL timeout 2        |   |
| [33]   | Digital input DI18  |   |
| [34]   | Digital input DI19  |   |
| [35]   | Digital input DI27  |   |
| [36]   | Digital input DI29  | <div style="text-align: center; background-color: #cccccc; padding: 5px;"><b>NOTICE</b></div> <p>This option is only available in FC 302.</p> |
| [37]   | Digital input DI32  |   |
| [38]   | Digital input DI33  |   |
| [39]   | Start command       |   |
| [40]   | Drive stopped       |   |
| [41]   | Reset trip          |   |
| [42]   | Auto-reset trip     |   |
| [43]   | OK key              |   |
| [44]   | Reset key           |   |
| [45]   | Left key            |   |
| [46]   | Right key           |   |
| [47]   | Up key              |   |
| [48]   | Down key            |   |
| [50]   | Comparator 4        |   |
| [51]   | Comparator 5        |   |
| [60]   | Logic rule 4        |   |
| [61]   | Logic rule 5        |   |
| [70]   | SL time-out 3       | Smart logic controller time 3 is timed out.   |
| [71]   | SL time-out 4       | Smart logic controller time 4 is timed out.   |
| [72]   | SL time-out 5       | Smart logic controller time 5 is timed out.   |
| [73]   | SL time-out 6       | Smart logic controller time 6 is timed out.   |
| [74]   | SL time-out 7       | Smart logic controller time 7 is timed out.   |
| [75]   | Start command given |   |
| [76]   | Digital input X30/2 |   |
| [77]   | Digital input X30/3 |   |
| [78]   | Digital input X30/4 |   |

| Option | Name                   | Description  |
|--------|------------------------|--|
| [79]   | Digital input X46/1    |  |
| [80]   | Digital input X46/3    |  |
| [81]   | Digital input X46/5    |  |
| [82]   | Digital input X46/7    |  |
| [83]   | Digital input X46/9    |  |
| [84]   | Digital input X46/11   |  |
| [85]   | Digital input X46/13   |  |
| [90]   | ATEX ETR cur. warning  | Available if <i>parameter 1-90 Motor Thermal Protection</i> is set to [20] ATEX ETR or [21] Advanced ETR. If the <i>alarm 164, ATEX ETR cur.lim.alarm</i> is active, the output is 1.  |
| [91]   | ATEX ETR cur. alarm    | Available if <i>parameter 1-90 Motor Thermal Protection</i> is set to [20] ATEX ETR or [21] Advanced ETR. If <i>alarm 166, ATEX ETR freq.lim.alarm</i> is active, the output is 1.     |
| [92]   | ATEX ETR freq. warning | Available if <i>parameter 1-90 Motor Thermal Protection</i> is set to [20] ATEX ETR or [21] Advanced ETR. If <i>alarm 163, ATEX ETR cur.lim.warning</i> is active, the output is 1.    |
| [93]   | ATEX ETR freq. alarm   | Available if <i>parameter 1-90 Motor Thermal Protection</i> is set to [20] ATEX ETR or [21] Advanced ETR. If <i>warning 165, ATEX ETR freq.lim.warning</i> is active, the output is 1. |
| [94]   | RS flipflop 0          | See <i>parameter group 13-1* Comparators</i> .   |
| [95]   | RS flipflop 1          | See <i>parameter group 13-1* Comparators</i> .   |
| [96]   | RS flipflop 2          | See <i>parameter group 13-1* Comparators</i> .   |
| [97]   | RS flipflop 3          | See <i>parameter group 13-1* Comparators</i> .   |
| [98]   | RS flipflop 4          | See <i>parameter group 13-1* Comparators</i> .   |
| [99]   | RS flipflop 5          | See <i>parameter group 13-1* Comparators</i> .   |
| [100]  | RS flipflop 6          | See <i>parameter group 13-1* Comparators</i> .   |
| [101]  | RS flipflop 7          | See <i>parameter group 13-1* Comparators</i> .   |
| [102]  | Relay 1                |  |
| [103]  | Relay 2                |  |
| [104]  | Relay 3                | X47/VLT® Extended Relay Card MCB 113.  |
| [105]  | Relay 4                | X47/VLT® Extended Relay Card MCB 113.  |
| [106]  | Relay 5                | X47/VLT® Extended Relay Card MCB 113.  |
| [107]  | Relay 6                | X47/VLT® Extended Relay Card MCB 113.  |
| [108]  | Relay 7                | X34/VLT® Relay Card MCB 105.   |
| [109]  | Relay 8                | X34/VLT® Relay Card MCB 105.   |
| [110]  | Relay 9                | X34/VLT® Relay Card MCB 105.   |
| [212]  | Emergency mode         |  |
| [222]  | Homing OK              |  |

| Option | Name                | Description |
|--------|---------------------|-------------|
| [223]  | On target           |             |
| [224]  | Position error      |             |
| [225]  | Position limit      |             |
| [226]  | Touch on target     |             |
| [227]  | Touch activated     |             |
| [228]  | Comparator 6        |             |
| [229]  | Comparator 7        |             |
| [230]  | Comarator 8         |             |
| [231]  | Comparator 9        |             |
| [232]  | Logic rule 6        |             |
| [233]  | Logic rule 7        |             |
| [234]  | Logic rule 8        |             |
| [235]  | Logic rule 9        |             |
| [236]  | SL time-out 8       |             |
| [237]  | SL time-out 9       |             |
| [238]  | RS flipflop 8       |             |
| [239]  | RS flipflop 9       |             |
| [240]  | SL digital output A |             |
| [241]  | SL digital output B |             |
| [242]  | SL digital output C |             |
| [243]  | SL digital output D |             |
| [244]  | SL digital output E |             |
| [245]  | SL digital output F |             |

Parameter 13-03 Reset SLC

Table 673: Parameter 13-03 Reset SLC

| 13-03 Reset SLC                     |                        |                               |
|-------------------------------------|------------------------|-------------------------------|
| Default value: [0] D0 not reset SLC | Parameter type: Option | Setup: All setups             |
| Conversion index: -                 | Data type: Uint8       | Change during operation: True |

| Option | Name             | Description  |
|--------|------------------|--|
| [0]*   | Do not reset SLC | Retain programmed settings in <i>parameter group 13-** Smart Logic</i> |
| [1]    | Reset SLC        | Reset all parameters in <i>parameter group 13-** Smart Logic</i>       |

### 5.13.2 13-1\* Comparators

Comparators are used for comparing continuous variables (that is output frequency, output current, analog input, and so on) to fixed preset values.

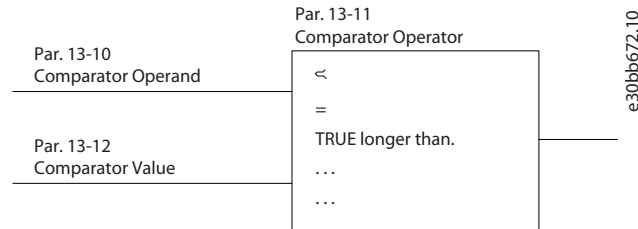

Illustration 79: Comparators

There are digital values that are compared to fixed time values. See the explanation in *parameter 13-10 Comparator Operand*. Comparators are evaluated once in each scan interval. Use the result (true or false) directly. All parameters in this parameter group are array parameters with index 0–9. Select index 0 to program comparator 0, select index 1 to program comparator 1, and so on.

#### Parameter 13-10 Comparator Operand

Table 674: Parameter 13-10 Comparator Operand

| 13-10 Comparator Operand    |                                    |                               |
|-----------------------------|------------------------------------|-------------------------------|
| Default value: Size related | Parameter type: Option, Array [10] | Setup: 2 setups               |
| Conversion index: -         | Data type: Uint8                   | Change during operation: True |

Options [1] Reference % to [31] Counter B are variables which are compared based on their values. Options [50] FALSE to [186] Drive in auto mode are digital values (true/false) where the comparison is based on the amount of time during which they are set to true or false. See *parameter 13-11 Comparator Operator*.

| Option | Name                | Description   |
|--------|---------------------|---|
| [0]    | DISABLED            | The comparator is disabled.                                       |
| [1]    | Reference %         | The resulting remote reference in %.                              |
| [2]    | Feedback %          | [RPM] or [Hz], as set in <i>parameter 0-02 Motor Speed Unit</i> . |
| [3]    | Motor speed         | [RPM] or [Hz], as set in <i>parameter 0-02 Motor Speed Unit</i> . |
| [4]    | Motor current       |   |
| [5]    | Motor torque        |   |
| [6]    | Motor power         |   |
| [7]    | Motor voltage       |   |
| [8]    | DC-link voltage     |   |
| [9]    | Motor thermal       | The value is in %.  |
| [10]   | Drive thermal       | The value is in %.  |
| [11]   | Heat sink temp.     | The value is in %.  |
| [12]   | Analog input AI53   | The value is in %.  |
| [13]   | Analog input AI54   | The value is in %.  |
| [14]   | Analog input AIFB10 | AIFB10 is internal 10 V supply.                                   |
| [15]   | Analog input AIS24V | AIS24V is a 24 V switch mode power supply.                        |

| Option | Name                  | Description  |
|--------|-----------------------|--|
| [17]   | Analog input AICCT    | Value is in [°]. AICCT is control card temperature.  |
| [18]   | Pulse input FI29      | <p style="text-align: center;"><b>NOTICE</b></p> <p>This option is only available in FC 302.</p> <p>The value is in %.</p>   |
| [19]   | Pulse input FI33      | The value is in %.   |
| [20]   | Alarm number          | <p>Shows the actual alarm number.</p> <p style="text-align: center;"><b>NOTICE</b></p> <p>With this selection, it is not possible to use &lt; and &gt; as comparator operators.</p> <p style="text-align: center;"><b>NOTICE</b></p> <p>Several alarms/warnings can be present at the same time. As the alarm/warning numbers are not grouped in a predefined order, defining a range is not relevant.</p>   |
| [21]   | Warning number        | <p>Shows the actual warning number.</p> <p style="text-align: center;"><b>NOTICE</b></p> <p>With this selection, it is not possible to use &lt; and &gt; as comparator operators.</p> <p style="text-align: center;"><b>NOTICE</b></p> <p>Several alarms/warnings can be present at the same time. As the alarm/warning numbers are not grouped in a predefined order, defining a range is not relevant.</p> |
| [22]   | Analog input X30/11   |  |
| [23]   | Analog input X30/12   |  |
| [30]   | Counter A             |  |
| [31]   | Counter B             |  |
| [32]   | Process PID error     | Value of the PID error ( <i>parameter 18-90 Process PID Error</i> ).   |
| [33]   | Process PID Output    | Value of the PID output ( <i>parameter 18-91 Process PID Output</i> ).   |
| [34]   | Analog input X48/2    |  |
| [35]   | Temp input X48/4      |  |
| [36]   | Temp input X48/7      |  |
| [37]   | Temp input X48/10     |  |
| [39]   | Safe opt. speed error |  |
| [43]   | Analog input X49/1    |  |
| [44]   | Analog input X49/3    |  |

| Option | Name                  | Description   |
|--------|-----------------------|---|
| [45]   | Analog input X49/5    |   |
| [50]   | FALSE                 | Use to enter the fixed value <i>False</i> in the comparator.  |
| [51]   | TRUE                  | Use to enter <i>True</i> in the comparator.   |
| [52]   | Control ready         | The control board receives supply voltage.  |
| [53]   | Drive ready           | The drive is ready for operation and applies a signal on the control board.   |
| [54]   | Running               | The motor runs.   |
| [55]   | Reversing             | The output is active when the drive runs counterclockwise (the logical product of the status bits running AND reverse).   |
| [56]   | In range              | The motor runs within the programmed current and speed ranges set in <i>parameter 4-50 Warning Current Low</i> to <i>parameter 4-53 Warning Speed High</i> .                          |
| [60]   | On reference          | The motor runs on reference.  |
| [61]   | Below reference, low  | The motor runs at a reference which is less than the value in <i>parameter 4-54 Warning Reference Low</i> .   |
| [62]   | Above ref, high       | The motor runs at a reference which exceeds the value in <i>parameter 4-55 Warning Reference High</i> .   |
| [65]   | Torque limit          | The torque exceeds the value in <i>parameter 4-16 Torque Limit Motor Mode</i> or <i>parameter 4-17 Torque Limit Generator Mode</i> .  |
| [66]   | Current limit         | The motor current exceeds the value in <i>parameter 4-18 Current Limit</i> .  |
| [67]   | Out of current range  | The motor current is outside the range set in <i>parameter 4-18 Current Limit</i> .   |
| [68]   | Below I low           | The motor current is lower than the value in <i>parameter 4-50 Warning Current Low</i> .  |
| [69]   | Above I high          | The motor current is higher than the value in <i>parameter 4-51 Warning Current High</i> .  |
| [70]   | Out of speed range    | The speed is outside the range set in <i>parameter 4-52 Warning Speed Low</i> and <i>parameter 4-53 Warning Speed High</i> .  |
| [71]   | Below speed low       | The output speed is lower than the value in <i>parameter 4-52 Warning Speed Low</i> .   |
| [72]   | Above speed high      | The output speed is higher than the value in <i>parameter 4-53 Warning Speed High</i> .   |
| [75]   | Out of feedback range | The feedback is outside the range set in <i>parameter 4-56 Warning Feedback Low</i> and <i>parameter 4-57 Warning Feedback High</i> .   |
| [76]   | Below feedback low    | The feedback is lower than the limit set in <i>parameter 4-56 Warning Feedback Low</i> .  |
| [77]   | Above feedback high   | The feedback exceeds the limit set in <i>parameter 4-57 Warning Feedback High</i> .   |
| [80]   | Thermal warning       | This operand becomes true when the drive detects any thermal warning, for instance when the temperature exceeds the limit in the motor, the drive, the brake resistor, or thermistor. |
| [82]   | Mains out of range    | The mains voltage is outside the specified voltage range.   |
| [85]   | Warning               | If a warning is triggered, this operand gets the warning number.  |
| [86]   | Alarm (trip)          | A trip alarm is active.   |
| [87]   | Alarm (trip lock)     | A trip lock alarm is active.  |
| [90]   | Bus OK                | Active communication (no timeout) via the serial communication port.  |

| Option | Name                | Description   |
|--------|---------------------|---|
| [91]   | Torque limit & stop | If the drive has received a stop signal and is at the torque limit, the signal is logic 0.  |
| [92]   | Brake fault (IGBT)  | The brake IGBT is short-circuited.  |
| [93]   | Mech. brake control | The mechanical brake is active.   |
| [94]   | Safe stop active    | <div style="text-align: center; background-color: #cccccc; padding: 5px;"><b>NOTICE</b></div> <p>This option is only available in FC 302.</p> |
| [100]  | Comparator 0        | The result of comparator 0.   |
| [101]  | Comparator 1        | The result of comparator 1.   |
| [102]  | Comparator 2        | The result of comparator 2.   |
| [103]  | Comparator 3        | The result of comparator 3.   |
| [104]  | Comparator 4        | The result of comparator 4.   |
| [105]  | Comparator 5        | The result of comparator 5.   |
| [106]  | Comparator 6        | The result of comparator 6.   |
| [107]  | Comparator 7        | The result of comparator 7.   |
| [108]  | Comparator 8        | The result of comparator 8.   |
| [109]  | Comparator 9        | The result of comparator 9.   |
| [110]  | Logic rule 0        | The result of logic rule 0.   |
| [111]  | Logic rule 1        | The result of logic rule 1.   |
| [112]  | Logic rule 2        | The result of logic rule 2.   |
| [113]  | Logic rule 3        | The result of logic rule 3.   |
| [114]  | Logic rule 4        | The result of logic rule 4.   |
| [115]  | Logic rule 5        | The result of logic rule 5.   |
| [116]  | Logic rule 6        | The result of logic rule 6.   |
| [117]  | Logic rule 7        | The result of logic rule 7.   |
| [118]  | Logic rule 8        | The result of logic rule 8.   |
| [119]  | Logic rule 9        | The result of logic rule 9.   |
| [120]  | SL time-out 0       | The result of the SLC timer 0.  |
| [121]  | SL time-out 1       | The result of the SLC timer 1.  |
| [122]  | SL time-out 2       | The result of the SLC timer 2.  |
| [123]  | SL time-out 3       | The result of the SLC timer 3.  |
| [124]  | SL time-out 4       | The result of the SLC timer 4.  |
| [125]  | SL time-out 5       | The result of the SLC timer 5.  |



| Option | Name                | Description                         |
|--------|---------------------|-------------------------------------|
| [126]  | SL time-out 6       | The result of the SLC timer 6.      |
| [127]  | SL time-out 7       | The result of the SLC timer 7.      |
| [128]  | SL time-out 8       | The result of the SLC timer 8.      |
| [129]  | SL time-out 9       | The result of the SLC timer 9.      |
| [130]  | Digital input DI18  | Digital input 18 (high=true).       |
| [131]  | Digital input DI19  | Digital input 19 (high=true).       |
| [132]  | Digital input DI27  | Digital input 27 (high=true).       |
| [133]  | Digital input DI29  | Digital input 29 (high=true)        |
| [134]  | Digital input DI32  | Digital input 32 (high=true).       |
| [135]  | Digital input DI33  | Digital input 33 (high=true).       |
| [136]  | RS flipflop 0       |                                     |
| [137]  | RS flipflop 1       |                                     |
| [138]  | RS flipflop 2       |                                     |
| [139]  | RS flipflop 3       |                                     |
| [140]  | RS flipflop 4       |                                     |
| [141]  | RS flipflop 5       |                                     |
| [142]  | RS flipflop 6       |                                     |
| [143]  | RS flipflop 7       |                                     |
| [144]  | RS flipflop 8       |                                     |
| [145]  | RS flipflop 9       |                                     |
| [150]  | SL digital output A | Use the result of the SLC output A. |
| [151]  | SL digital output B | Use the result of the SLC output B. |
| [152]  | SL digital output C | Use the result of the SLC output C. |
| [153]  | SL digital output D | Use the result of the SLC output D. |
| [154]  | SL digital output E | Use the result of the SLC output E. |
| [155]  | SL digital output F | Use the result of the SLC output F. |
| [160]  | Relay 1             | Relay 1 is active.                  |
| [161]  | Relay 2             | Relay 2 is active.                  |
| [162]  | Relay 3             |                                     |
| [163]  | Relay 4             |                                     |
| [164]  | Relay 5             |                                     |
| [165]  | Relay 6             |                                     |

| Option | Name                    | Description   |
|--------|-------------------------|---|
| [166]  | Relay 7                 |   |
| [167]  | Relay 8                 |   |
| [168]  | Relay 9                 |   |
| [180]  | Local reference active  | Active when <i>parameter 3-13 Reference Site</i> is [2] <i>Local</i> or when <i>parameter 3-13 Reference Site</i> is [0] <i>Linked to hand/auto</i> , at the same time as the LCP is in hand-on mode.   |
| [181]  | Remote reference active | Active when <i>parameter 3-13 Reference Site</i> is [1] <i>Remote</i> or [0] <i>Linked to hand/auto</i> , while the LCP is in auto-on mode.   |
| [182]  | Start command           | Active when there is an active start command and no stop command.   |
| [183]  | Drive stopped           | A stop command (jog, stop, qstop, coast) is issued – and not from the SLC itself.   |
| [185]  | Drive in hand mode      | Active when the drive is in hand-on mode.   |
| [186]  | Drive in auto mode      | Active when the drive is in auto-on mode.   |
| [187]  | Start command given     |   |
| [190]  | Digital input X30/2     |   |
| [191]  | Digital input X30/3     |   |
| [192]  | Digital input X30/4     |   |
| [193]  | Digital input X46/1     |   |
| [194]  | Digital input X46/3     |   |
| [195]  | Digital input X46/5     |   |
| [196]  | Digital input X46/7     |   |
| [197]  | Digital input X46/9     |   |
| [198]  | Digital input X46/11    |   |
| [199]  | Digital input X46/13    |   |
| [212]  | Emergency mode          |   |
| [222]  | Homing OK               | <p style="text-align: center;"><b>NOTICE</b></p> <p>This option is only available with software version 48.2X and newer.</p> <p>Homing is completed with the selected homing function (<i>parameter 17-80 Homing Function</i>).</p>   |
| [223]  | On target               | <p style="text-align: center;"><b>NOTICE</b></p> <p>This option is only available with software version 48.2X and newer.</p> <p>Positioning is completed and the on-target signal is sent when the actual position is within <i>parameter 3-05 On Reference Window</i> for the duration of <i>parameter 3-09 On Target Time</i> and the actual speed does not exceed <i>parameter 3-05 On Reference Window</i>.</p> |

| Option | Name                | Description  |
|--------|---------------------|--|
| [224]  | Position error      | <p style="text-align: center;"><b>NOTICE</b></p> <p>This option is only available with software version 48.2X and newer.</p> <p>The position error exceeds the value in <i>parameter 4-71 Maximum Position Error</i> for the time set in <i>parameter 4-72 Position Error Timeout</i>.</p> |
| [225]  | Position limit      | <p style="text-align: center;"><b>NOTICE</b></p> <p>This option is only available with software version 48.2X and newer.</p> <p>The position is outside the limits set in <i>parameter 3-06 Minimum Position</i> and <i>parameter 3-07 Maximum Position</i>.</p>                           |
| [226]  | Touch on target     | <p style="text-align: center;"><b>NOTICE</b></p> <p>This option is only available with software version 48.2X and newer.</p> <p>Target position is reached in touch probe position mode.</p>   |
| [227]  | Touch activated     | <p style="text-align: center;"><b>NOTICE</b></p> <p>This option is only available with software version 48.2X and newer.</p> <p>Touch probe positioning is active. The drive monitors the touch probe sensor input.</p>  |
| [249]  | Therm. sensor temp. |  |

Parameter 13-11 Comparator Operator

Table 675: Parameter 13-11 Comparator Operator

| 13-11 Comparator Operator   |                                    |                               |
|-----------------------------|------------------------------------|-------------------------------|
| Default value: Size related | Parameter type: Option, Array [10] | Setup: 2 setups               |
| Conversion index: -         | Data type: Uint8                   | Change during operation: True |

Select the operator to be used in the comparison. This is an array parameter containing comparator operators 0–5.

| Op-tion | Name      | Description   |
|---------|-----------|---|
| [0]     | <         | <p style="text-align: center;"><b>NOTICE</b></p> <p>If [20] Alarm number or [21] Warning number is selected in <i>parameter 3-10 Comparator Operand</i>, [0] &lt; cannot be selected in this parameter.</p> <p>The result of the evaluation is true when the variable selected in <i>parameter 13-10 Comparator Operand</i> is smaller than the fixed value in <i>parameter 13-12 Comparator Value</i>. The result is false if the variable selected in <i>parameter 13-10 Comparator Operand</i> is greater than the fixed value in <i>parameter 13-12 Comparator Value</i>.</p> |
| [1]     | ≈ (equal) | The result of the evaluation is true when the variable selected in <i>parameter 13-10 Comparator Operand</i> is approximately equal to the fixed value in <i>parameter 13-12 Comparator Value</i> .   |

| Option | Name                 | Description  |
|--------|----------------------|--|
| [2]    | >                    | <div style="text-align: center; background-color: #cccccc; padding: 5px;"><b>NOTICE</b></div> <p>If [20] Alarm number or [21] Warning number is selected in parameter 3-10 Comparator Operand, [2] &gt; cannot be selected in this parameter.</p> <p>Inverse logic of option [0] &lt;.</p> |
| [5]    | TRUE longer than..   |  |
| [6]    | FALSE longer than..  |  |
| [7]    | TRUE shorter than..  |  |
| [8]    | FALSE shorter than.. |  |

Parameter 13-12 Comparator Value

Table 676: Parameter 13-12 Comparator Value

| 13-12 Comparator Value      |   |                               |
|-----------------------------|---|-------------------------------|
| Default value: Size related | Parameter type: Range, -100000.000 - 100000, Array [10] | Setup: 2 setups               |
| Conversion index: -3        | Data type: Int32  | Change during operation: True |

Enter the trigger level for the variable that is monitored by this comparator. This is an array parameter containing comparator values 0–9.

5.13.2.1 RS FlipFlops

The reset/set flipflops hold the signal until set/reset.

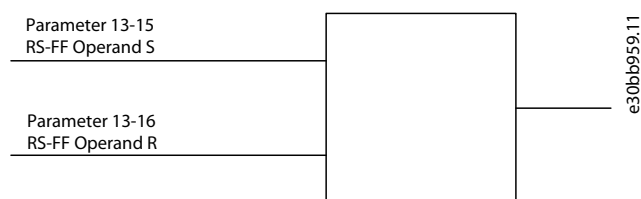

Illustration 80: Reset/Set Flipflops

Two parameters are used and the output can be used in the logic rules and as events.

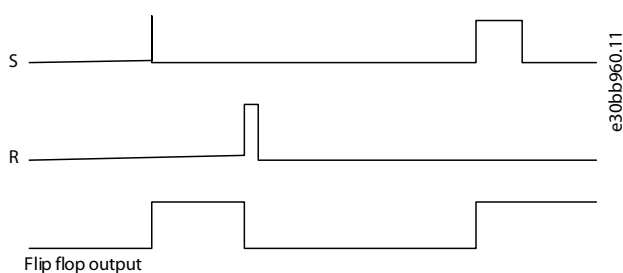

Illustration 81: Flipflop Outputs

The 2 operators can be selected from a long list. As a special case, the same digital input can be used as both set and reset, making it possible to use the same digital input as start/stop. The following settings can be used to set up the same digital input (for example, DI32) as start/stop.

Table 677: Operators

| Parameter                                  | Setting                 | Notes  |
|--|-------------------------|--|
| Parameter 13-00 SL Controller Mode         | [1] On                  | –  |
| Parameter 13-01 Start Event [0]            | True                    | –  |
| Parameter 13-02 Stop Event [0]             | False                   | –  |
| Parameter 13-40 Logic Rule Boolean 1 [0]   | [37] Digital input DI32 | –  |
| Parameter 13-42 Logic Rule Boolean 2 [0]   | [2] Running             | –  |
| Parameter 13-41 Logic Rule Operator 1 [0]  | [3] AND NOT             | –  |
| Parameter 13-40 Logic Rule Boolean 1 [1]   | [37] Digital input DI32 | –  |
| Parameter 13-42 Logic Rule Boolean 2 [1]   | [2] Running             | –  |
| Parameter 13-41 Logic Rule Operator 1 [1]  | [1] AND                 | –  |
| Parameter 13-15 RS-FF Operand S [0]        | [26] Logic rule 0       | Output from parameter 13-41 Logic Rule Operator 1 [0].                         |
| Parameter 13-16 RS-FF Operand R [0]        | [27] Logic rule 1       | Output from parameter 13-41 Logic Rule Operator 1 [1].                         |
| Parameter 13-51 SL Controller 1 Event [0]  | [94] RS Flipflop 0      | Output from parameter 13-15 RSFF Operand S and parameter 13-16 RSFF Operand R. |
| Parameter 13-52 SL Controller 1 Action [0] | [22] Run                | –  |
| Parameter 13-51 SL Controller 1 Event [1]  | [27] Logic rule 1       | –  |
| Parameter 13-52 SL Controller 1 Action [1] | [24] Stop               | –  |

## Parameter 13-15 RS-FF Operand S

Table 678: Parameter 13-15 RS-FF Operand S

| 13-15 RS-FF Operand S       |                                    |                               |
|-----------------------------|------------------------------------|-------------------------------|
| Default value: Size related | Parameter Type: option, Array [10] | Setup: 2 setups               |
| Conversion index: -         | Data type: Uint8                   | Change during operation: True |

| Option | Name         | Description |
|--------|--------------|-------------|
| [0]    | False        |             |
| [1]    | True         |             |
| [2]    | Running      |             |
| [3]    | In range     |             |
| [4]    | On reference |             |

| Option | Name                 | Description |
|--------|----------------------|-------------|
| [5]    | Torque limit         |             |
| [6]    | Current limit        |             |
| [7]    | Out of current range |             |
| [8]    | Below I low          |             |
| [9]    | Above I high         |             |
| [10]   | Out of speed range   |             |
| [11]   | Below speed low      |             |
| [12]   | Above speed high     |             |
| [13]   | Out of feedb. range  |             |
| [14]   | Below feedb. low     |             |
| [15]   | Above feedb. high    |             |
| [16]   | Thermal warning      |             |
| [17]   | Mains out of range   |             |
| [18]   | Reversing            |             |
| [19]   | Warning              |             |
| [20]   | Alarm (trip)         |             |
| [21]   | Alarm (trip lock)    |             |
| [22]   | Comparator 0         |             |
| [23]   | Comparator 1         |             |
| [24]   | Comparator 2         |             |
| [25]   | Comparator 3         |             |
| [26]   | Logic rule 0         |             |
| [27]   | Logic rule 1         |             |
| [28]   | Logic rule 2         |             |
| [29]   | Logic rule 3         |             |
| [30]   | SL time-out 0        |             |
| [31]   | SL time-out 1        |             |
| [32]   | SL time-out 2        |             |
| [33]   | Digital input DI18   |             |
| [34]   | Digital input DI19   |             |
| [35]   | Digital input DI27   |             |

| Option | Name                | Description   |
|--------|---------------------|---|
| [36]   | Digital input DI29  | <div style="text-align: center; background-color: #cccccc; padding: 5px;"><b>NOTICE</b></div> <div style="border: 1px solid black; padding: 5px; margin-top: 5px;">This option is only available in FC 302.</div> |
| [37]   | Digital input DI32  |   |
| [38]   | Digital input DI33  |   |
| [39]   | Start command       |   |
| [40]   | Drive stopped       |   |
| [41]   | Reset trip          |   |
| [42]   | Auto-reset trip     |   |
| [43]   | OK key              | [OK] is pressed. Only available on the graphical LCP.   |
| [44]   | Reset key           | [Reset] is pressed. Only available on the graphical LCP.  |
| [45]   | Left key            | [◀] is pressed. Only available on the graphical LCP.  |
| [46]   | Right key           | [▶] is pressed. Only available on the graphical LCP.  |
| [47]   | Up key              | [▲] is pressed. Only available on the graphical LCP.  |
| [48]   | Down key            | [▼] is pressed. Only available on the graphical LCP.  |
| [50]   | Comparator 4        |   |
| [51]   | Comparator 5        |   |
| [60]   | Logic rule 4        |   |
| [61]   | Logic rule 5        |   |
| [70]   | SL time-out 3       |   |
| [71]   | SL time-out 4       |   |
| [72]   | SL time-out 5       |   |
| [73]   | SL time-out 6       |   |
| [74]   | SL time-out 7       |   |
| [75]   | Start command given |   |
| [76]   | Digital input X30/2 |   |
| [77]   | Digital input X30/3 |   |
| [78]   | Digital input X30/4 |   |
| [79]   | Digital input 46/1  |   |
| [80]   | Digital input 46/3  |   |
| [81]   | Digital input 46/5  |   |
| [82]   | Digital input 46/7  |   |

| Option | Name                   | Description   |
|--------|------------------------|---|
| [83]   | Digital input 46/9     |   |
| [84]   | Digital input 46/11    |   |
| [85]   | Digital input X46/13   |   |
| [90]   | ATEX ETR cur. warning  |   |
| [91]   | ATEX ETR cur. alarm    |   |
| [92]   | ATEX ETR freq. warning |   |
| [93]   | ATEX ETR freq. alarm   |   |
| [94]   | RS Flipflop 0          |   |
| [95]   | RS Flipflop 1          |   |
| [96]   | RS Flipflop 2          |   |
| [97]   | RS Flipflop 3          |   |
| [98]   | RS Flipflop 4          |   |
| [99]   | RS Flipflop 5          |   |
| [100]  | RS Flipflop 6          |   |
| [101]  | RS Flipflop 7          |   |
| [102]  | Relay 1                |   |
| [103]  | Relay 2                |   |
| [104]  | Relay 3                | X47/VLT® Extended Relay Card MCB 113.   |
| [105]  | Relay 4                | X47/VLT® Extended Relay Card MCB 113.   |
| [106]  | Relay 5                | X47/VLT® Extended Relay Card MCB 113.   |
| [107]  | Relay 6                | X47/VLT® Extended Relay Card MCB 113.   |
| [108]  | Relay 7                | X34/VLT® Relay Card MCB 105.  |
| [109]  | Relay 8                | X34/VLT® Relay Card MCB 105.  |
| [110]  | Relay 9                | X34/VLT® Relay Card MCB 105.  |
| [212]  | Emergency mode         |   |
| [222]  | Homing OK              | <p style="text-align: center;"><b>NOTICE</b></p> <p>This option is only available with software version 48.2X and newer.</p> <p>Homing is completed with the selected homing function (<i>parameter 17-80 Homing Function</i>).</p> |
| [223]  | On target              | <p style="text-align: center;"><b>NOTICE</b></p> <p>This option is only available with software version 48.2X and newer.</p>  |



| Option | Name                | Description  |
|--------|---------------------|--|
|        |                     | Positioning is completed and the on-target signal is sent when the actual position is within <i>parameter 3-05 On Reference Window</i> for the duration of <i>parameter 3-09 On Target Time</i> and the actual speed does not exceed <i>parameter 3-05 On Reference Window</i> .           |
| [224]  | Position error      | <p style="text-align: center;"><b>NOTICE</b></p> <p>This option is only available with software version 48.2X and newer.</p> <p>The position error exceeds the value in <i>parameter 4-71 Maximum Position Error</i> for the time set in <i>parameter 4-72 Position Error Timeout</i>.</p> |
| [225]  | Position limit      | <p style="text-align: center;"><b>NOTICE</b></p> <p>This option is only available with software version 48.2X and newer.</p> <p>The position is outside the limits set in <i>parameter 3-06 Minimum Position</i> and <i>parameter 3-07 Maximum Position</i>.</p>                           |
| [226]  | Touch on target     | <p style="text-align: center;"><b>NOTICE</b></p> <p>This option is only available with software version 48.2X and newer.</p> <p>Target position is reached in touch probe position mode.</p>   |
| [227]  | Touch activated     | Touch probe positioning active. The drive monitors the touch probe sensor input.   |
| [228]  | Comparator 6        |  |
| [229]  | Comparator 7        |  |
| [230]  | Comparator 8        |  |
| [231]  | Comparator 9        |  |
| [232]  | Logic rule 6        |  |
| [233]  | Logic rule 7        |  |
| [234]  | Logic rule 8        |  |
| [235]  | Logic rule 9        |  |
| [236]  | SL time-out 8       |  |
| [237]  | SL time-out 9       |  |
| [238]  | RS flipflop 8       |  |
| [239]  | RS flipflop 9       |  |
| [240]  | SL digital output A |  |
| [241]  | SL digital output B |  |
| [242]  | SL digital output C |  |

| Option | Name                | Description |
|--------|---------------------|-------------|
| [243]  | SL digital output D |             |
| [244]  | SL digital output E |             |
| [245]  | SL digital output F |             |

Parameter 13-16 RS-FF Operand R

Table 679: Parameter 13-16 RS-FF Operand R

| 13-16 RS-FF Operand R       |                                    |                               |
|-----------------------------|------------------------------------|-------------------------------|
| Default value: Size related | Parameter type: Option, Array [10] | Setup: 2 setups               |
| Conversion index: -         | Data type: Uint8                   | Change during operation: True |

| Option | Name                 | Description |
|--------|----------------------|-------------|
| [0]    | False                |             |
| [1]    | True                 |             |
| [2]    | Running              |             |
| [3]    | In range             |             |
| [4]    | On reference         |             |
| [5]    | Torque limit         |             |
| [6]    | Current limit        |             |
| [7]    | Out of current range |             |
| [8]    | Below I low          |             |
| [9]    | Above I high         |             |
| [10]   | Out of speed range   |             |
| [11]   | Below speed low      |             |
| [12]   | Above speed high     |             |
| [13]   | Out of feedb. range  |             |
| [14]   | Below feedb. low     |             |
| [15]   | Above feedb. high    |             |
| [16]   | Thermal warning      |             |
| [17]   | Mains out of range   |             |
| [18]   | Reversing            |             |
| [19]   | Warning              |             |
| [20]   | Alarm (trip)         |             |
| [21]   | Alarm (trip lock)    |             |
| [22]   | Comparator 0         |             |

| Option | Name               | Description   |
|--------|--------------------|---|
| [23]   | Comparator 1       |   |
| [24]   | Comparator 2       |   |
| [25]   | Comparator 3       |   |
| [26]   | Logic rule 0       |   |
| [27]   | Logic rule 1       |   |
| [28]   | Logic rule 2       |   |
| [29]   | Logic rule 3       |   |
| [30]   | SL time-out 0      |   |
| [31]   | SL time-out 1      |   |
| [32]   | SL time-out 2      |   |
| [33]   | Digital input DI18 |   |
| [34]   | Digital input DI19 |   |
| [35]   | Digital input DI27 |   |
| [36]   | Digital input DI29 | <div style="text-align: center; background-color: #cccccc; padding: 5px;"><b>NOTICE</b></div> <p>This option is only available in FC 302.</p> |
| [37]   | Digital input DI32 |   |
| [38]   | Digital input DI33 |   |
| [39]   | Start command      |   |
| [40]   | Drive stopped      |   |
| [41]   | Reset trip         |   |
| [42]   | Auto-reset trip    |   |
| [43]   | OK key             | [OK] is pressed. Only available on the graphical LCP.   |
| [44]   | Reset key          | [Reset] is pressed. Only available on the graphical LCP.  |
| [45]   | Left key           | [◀] is pressed. Only available on the graphical LCP.  |
| [46]   | Right key          | [▶] is pressed. Only available on the graphical LCP.  |
| [47]   | Up key             | [▲] is pressed. Only available on the graphical LCP.  |
| [48]   | Down key           | [▼] is pressed. Only available on the graphical LCP.  |
| [50]   | Comparator 4       |   |
| [51]   | Comparator 5       |   |
| [60]   | Logic rule 4       |   |
| [61]   | Logic rule 5       |   |

| Option | Name                   | Description                           |
|--------|------------------------|---------------------------------------|
| [70]   | SL time-out 3          |                                       |
| [71]   | SL time-out 4          |                                       |
| [72]   | SL time-out 5          |                                       |
| [73]   | SL time-out 6          |                                       |
| [74]   | SL time-out 7          |                                       |
| [75]   | Start command given    |                                       |
| [76]   | Digital input X30/2    |                                       |
| [77]   | Digital input X30/3    |                                       |
| [78]   | Digital input X30/4    |                                       |
| [79]   | Digital input 46/1     |                                       |
| [80]   | Digital input 46/3     |                                       |
| [81]   | Digital input 46/5     |                                       |
| [82]   | Digital input 46/7     |                                       |
| [83]   | Digital input 46/9     |                                       |
| [84]   | Digital input 46/11    |                                       |
| [85]   | Digital input X46/13   |                                       |
| [90]   | ATEX ETR cur. warning  |                                       |
| [91]   | ATEX ETR cur. alarm    |                                       |
| [92]   | ATEX ETR freq. warning |                                       |
| [93]   | ATEX ETR freq. alarm   |                                       |
| [94]   | RS Flipflop 0          |                                       |
| [95]   | RS Flipflop 1          |                                       |
| [96]   | RS Flipflop 2          |                                       |
| [97]   | RS Flipflop 3          |                                       |
| [98]   | RS Flipflop 4          |                                       |
| [99]   | RS Flipflop 5          |                                       |
| [100]  | RS Flipflop 6          |                                       |
| [101]  | RS Flipflop 7          |                                       |
| [102]  | Relay 1                |                                       |
| [103]  | Relay 2                |                                       |
| [104]  | Relay 3                | X47/VLT® Extended Relay Card MCB 113. |
| [105]  | Relay 4                | X47/VLT® Extended Relay Card MCB 113. |

| Option | Name            | Description   |
|--------|-----------------|---|
| [106]  | Relay 5         | X47/VLT® Extended Relay Card MCB 113.   |
| [107]  | Relay 6         | X47/VLT® Extended Relay Card MCB 113.   |
| [108]  | Relay 7         | X34/VLT® Relay Card MCB 105.  |
| [109]  | Relay 8         | X34/VLT® Relay Card MCB 105.  |
| [110]  | Relay 9         | X34/VLT® Relay Card MCB 105.  |
| [212]  | Emergency mode  |   |
| [222]  | Homing OK       | <p style="text-align: center;"><b>NOTICE</b></p> <p>This option is only available with software version 48.2X and newer.</p> <p>Homing is completed with the selected homing function (<i>parameter 17-80 Homing Function</i>).</p>   |
| [223]  | On target       | <p style="text-align: center;"><b>NOTICE</b></p> <p>This option is only available with software version 48.2X and newer.</p> <p>Positioning is completed and the on-target signal is sent when the actual position is within <i>parameter 3-05 On Reference Window</i> for the duration of <i>parameter 3-09 On Target Time</i> and the actual speed does not exceed <i>parameter 3-05 On Reference Window</i>.</p> |
| [224]  | Position error  | <p style="text-align: center;"><b>NOTICE</b></p> <p>This option is only available with software version 48.2X and newer.</p> <p>The position error exceeds the value in <i>parameter 4-71 Maximum Position Error</i> for the time set in <i>parameter 4-72 Position Error Timeout</i>.</p>  |
| [225]  | Position limit  | <p style="text-align: center;"><b>NOTICE</b></p> <p>This option is only available with software version 48.2X and newer.</p> <p>The position is outside the limits set in <i>parameter 3-06 Minimum Position</i> and <i>parameter 3-07 Maximum Position</i>.</p>  |
| [226]  | Touch on target | <p style="text-align: center;"><b>NOTICE</b></p> <p>This option is only available with software version 48.2X and newer.</p> <p>Target position is reached in touch probe position mode.</p>  |
| [227]  | Touch activated | <p style="text-align: center;"><b>NOTICE</b></p> <p>This option is only available with software version 48.2X and newer.</p> <p>Touch probe positioning active. The drive monitors the touch probe sensor input.</p>  |
| [228]  | Comparator 6    |   |

| Option | Name                | Description |
|--------|---------------------|-------------|
| [229]  | Comparator 7        |             |
| [230]  | Comparator 8        |             |
| [231]  | Comparator 9        |             |
| [232]  | Logic rule 6        |             |
| [233]  | Logic rule 7        |             |
| [234]  | Logic rule 8        |             |
| [235]  | Logic rule 9        |             |
| [236]  | SL time-out 8       |             |
| [237]  | SL time-out 9       |             |
| [238]  | RS flipflop 8       |             |
| [239]  | RS flipflop 9       |             |
| [240]  | SL digital output A |             |
| [241]  | SL digital output B |             |
| [242]  | SL digital output C |             |
| [243]  | SL digital output D |             |
| [244]  | SL digital output E |             |
| [245]  | SL digital output F |             |

### 5.13.3 13-2\* Timers

Use the result (true or false) from timers directly to define an event (see *parameter 13-51 SL Controller Event*), or as boolean input in a logic rule (see *parameter 13-40 Logic Rule Boolean 1*, *parameter 13-42 Logic Rule Boolean 2*, or *parameter 13-44 Logic Rule Boolean 3*). A timer is only false when started by an action (for example *[29] Start timer 1*) until the timer value entered in this parameter has elapsed. Then it becomes true again. All parameters in this parameter group are array parameters with index 0–9. Select index 0 to program timer 0, select index 1 to program timer 1, and so on.

Parameter 13-20 SL Controller Time

Table 680: Parameter 13-20 SL Controller Timer

| 13-20 SL Controller Timer   |  |                               |
|-----------------------------|--|-------------------------------|
| Default value: Size related | Parameter type: Range, 0 - 0, Array [10] | Setup: 1 setup                |
| Conversion index: -3        | Data type: Timediff w/o DateID           | Change during operation: True |

Enter the value to define the duration of the false output from the programmed timer. A timer is only false if it is started by an action (that is *[29] Start timer 1*) and until the given timer value has elapsed.

### 5.13.4 13-4\* Logic Rules

Combine up to 3 boolean inputs (true/false inputs) from timers, comparators, digital inputs, status bits, and events using the logical operators AND, OR, and NOT. Select boolean inputs for the calculation in *parameter 13-40 Logic Rule Boolean 1*, *parameter 13-42 Logic Rule Boolean 2*, and *parameter 13-44 Logic Rule Boolean 3*. Define the operators used to logically combine the selected inputs in *parameter 13-41 Logic Rule Operator 1* and *parameter 13-43 Logic Rule Operator 2*.

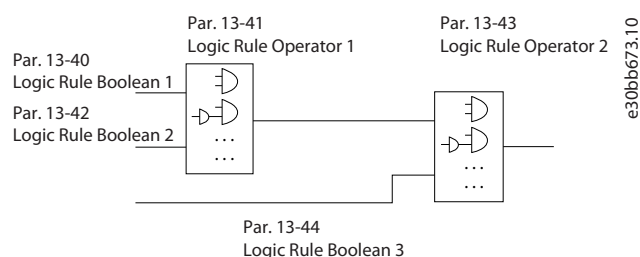

Illustration 82: Logic Rules

Priority of calculation

The results of *parameter 13-40 Logic Rule Boolean 1*, *parameter 13-41 Logic Rule Operator 1*, and *parameter 13-42 Logic Rule Boolean 2* are calculated first. The outcome (true/false) of this calculation is combined with the settings of *parameter 13-43 Logic Rule Operator 2* and *parameter 13-44 Logic Rule Boolean 3*, yielding the final result (true/false) of the logic rule.

Parameter 13-40 Logic Rule Boolean 1

Table 681: Parameter 13-40 Logic Rule Boolean 1

| 13-40 Logic Rule Boolean 1  |                                    |                               |
|-----------------------------|------------------------------------|-------------------------------|
| Default value: Size related | Parameter type: Option, Array [10] | Setup: 2 setups               |
| Conversion index: -         | Data Type: Uint8                   | Change during operation: True |

| Option | Name                 | Description  |
|--------|----------------------|--|
| [0]    | False                | Select the 1 <sup>st</sup> boolean (true or false) input for the selected logic rule. See <i>parameter 13-01 Start Event</i> and <i>parameter 13-02 Stop Event</i> for more information. |
| [1]    | True                 |  |
| [2]    | Running              |  |
| [3]    | In range             |  |
| [4]    | On reference         |  |
| [5]    | Torque limit         |  |
| [6]    | Current limit        |  |
| [7]    | Out of current range |  |
| [8]    | Below I low          |  |
| [9]    | Above I high         |  |
| [10]   | Out of speed range   |  |
| [11]   | Below speed low      |  |
| [12]   | Above speed high     |  |
| [13]   | Out of feedb. range  |  |
| [14]   | Below feedb. low     |  |
| [15]   | Above feedb. high    |  |
| [16]   | Thermal warning      |  |
| [17]   | Mains out of range   |  |
| [18]   | Reversing            |  |

| Option | Name               | Description   |
|--------|--------------------|---|
| [19]   | Warning            |   |
| [20]   | Alarm (trip)       |   |
| [21]   | Alarm (trip lock)  |   |
| [22]   | Comparator 0       |   |
| [23]   | Comparator 1       |   |
| [24]   | Comparator 2       |   |
| [25]   | Comparator 3       |   |
| [26]   | Logic rule 0       |   |
| [27]   | Logic rule 1       |   |
| [28]   | Logic rule 2       |   |
| [29]   | Logic rule 3       |   |
| [30]   | SL time-out 0      |   |
| [31]   | SL time-out 1      |   |
| [32]   | SL time-out 2      |   |
| [33]   | Digital input DI18 |   |
| [34]   | Digital input DI19 |   |
| [35]   | Digital input DI27 |   |
| [36]   | Digital input DI29 | <div style="text-align: center; background-color: #cccccc; padding: 5px;"><b>NOTICE</b></div> <p>This option is only available in FC 302.</p> |
| [37]   | Digital input DI32 |   |
| [38]   | Digital input DI33 |   |
| [39]   | Start command      |   |
| [40]   | Drive stopped      |   |
| [41]   | Reset trip         |   |
| [42]   | Auto-reset trip    |   |
| [43]   | OK key             | [OK] is pressed. Only available on the graphical LCP.   |
| [44]   | Reset key          | [Reset] is pressed. Only available on the graphical LCP.  |
| [45]   | Left key           | [◀] is pressed. Only available on the graphical LCP.  |
| [46]   | Right key          | [▶] is pressed. Only available on the graphical LCP.  |
| [47]   | Up key             | [▲] is pressed. Only available on the graphical LCP.  |
| [48]   | Down key           | [▼] is pressed. Only available on the graphical LCP.  |



| Option | Name                   | Description  |
|--------|------------------------|--|
| [50]   | Comparator 4           | Use the result of comparator 4.  |
| [51]   | Comparator 5           | Use the result of comparator 5.  |
| [60]   | Logic rule 4           | Use the result of logic rule 4.  |
| [61]   | Logic rule 5           | Use the result of logic rule 5.  |
| [70]   | SL time-out 3          |  |
| [71]   | SL time-out 4          |  |
| [72]   | SL time-out 5          |  |
| [73]   | SL time-out 6          |  |
| [74]   | SL time-out 7          |  |
| [75]   | Start command given    |  |
| [76]   | Digital input X30/2    |  |
| [77]   | Digital input X30/3    |  |
| [78]   | Digital input X30/4    |  |
| [79]   | Digital input X46/1    |  |
| [80]   | Digital input X46/3    |  |
| [81]   | Digital input X46/5    |  |
| [82]   | Digital input X46/7    |  |
| [83]   | Digital input X46/9    |  |
| [84]   | Digital input X46/11   |  |
| [85]   | Digital input X46/13   |  |
| [90]   | ATEX ETR cur. warning  | Available if <i>parameter 1-90 Motor Thermal Protection</i> is set to [20] ATEX ETR or [21] Advanced ETR. If <i>alarm 164, ATEX ETR cur.lim.alarm</i> is active, the output is 1.      |
| [91]   | ATEX ETR cur. alarm    | Available if <i>parameter 1-90 Motor Thermal Protection</i> is set to [20] ATEX ETR or [21] Advanced ETR. If <i>alarm 166, ATEX ETR freq.lim.alarm</i> is active, the output is 1.     |
| [92]   | ATEX ETR freq. warning | Available if <i>parameter 1-90 Motor Thermal Protection</i> is set to [20] ATEX ETR or [21] Advanced ETR. If <i>alarm 163, ATEX ETR cur.lim.warning</i> is active, the output is 1.    |
| [93]   | ATEX ETR freq. alarm   | Available if <i>parameter 1-90 Motor Thermal Protection</i> is set to [20] ATEX ETR or [21] Advanced ETR. If <i>warning 165, ATEX ETR freq.lim.warning</i> is active, the output is 1. |
| [94]   | RS Flipflop 0          | See <i>parameter group 13-1* Comparators</i> .   |
| [95]   | RS Flipflop 1          | See <i>parameter group 13-1* Comparators</i> .   |
| [96]   | RS Flipflop 2          | See <i>parameter group 13-1* Comparators</i> .   |
| [97]   | RS Flipflop 3          | See <i>parameter group 13-1* Comparators</i> .   |
| [98]   | RS Flipflop 4          | See <i>parameter group 13-1* Comparators</i> .   |
| [99]   | RS Flipflop 5          | See <i>parameter group 13-1* Comparators</i> .   |

| Option | Name            | Description  |
|--------|-----------------|--|
| [100]  | RS Flipflop 6   | See <i>parameter group 13-1* Comparators</i> .   |
| [101]  | RS Flipflop 7   | See <i>parameter group 13-1* Comparators</i> .   |
| [102]  | Relay 1         |  |
| [103]  | Relay 2         |  |
| [104]  | Relay 3         | X47/VLT® Extended Relay Card MCB 113.  |
| [105]  | Relay 4         | X47/VLT® Extended Relay Card MCB 113.  |
| [106]  | Relay 5         | X47/VLT® Extended Relay Card MCB 113.  |
| [107]  | Relay 6         | X47/VLT® Extended Relay Card MCB 113.  |
| [108]  | Relay 7         | X34/VLT® Relay Card MCB 105.   |
| [109]  | Relay 8         | X34/VLT® Relay Card MCB 105.   |
| [110]  | Relay 9         | X34/VLT® Relay Card MCB 105.   |
| [212]  | Emergency mode  |  |
| [222]  | Homing OK       | <p style="text-align: center;"><b>NOTICE</b></p> <p>This option is only available with software version 48.2X or newer.</p> <p>Homing is completed with the selected homing function (<i>parameter 17-80 Homing Function</i>).</p>   |
| [223]  | On target       | <p style="text-align: center;"><b>NOTICE</b></p> <p>This option is only available with software version 48.2X or newer.</p> <p>Positioning is completed and the on target signal is sent when the actual position is within <i>parameter 3-05 On Reference Window</i> for the duration of <i>parameter 3-09 On Target Time</i> and the actual speed does not exceed <i>parameter 3-05 On Reference Window</i>.</p> |
| [224]  | Position error  | <p style="text-align: center;"><b>NOTICE</b></p> <p>This option is only available with software version 48.2X or newer.</p> <p>The position error exceeds the value in <i>parameter 4-71 Maximum Position Error</i> for the time set in <i>parameter 4-72 Position Error Timeout</i>.</p>  |
| [225]  | Position limit  | <p style="text-align: center;"><b>NOTICE</b></p> <p>This option is only available with software version 48.2X or newer.</p> <p>The position is outside the limits set in <i>parameter 3-06 Minimum Position</i> and <i>parameter 3-07 Maximum Position</i>.</p>  |
| [226]  | Touch on target | <p style="text-align: center;"><b>NOTICE</b></p> <p>This option is only available with software version 48.2X or newer.</p>  |

| Option | Name                | Description   |
|--------|---------------------|---|
|        |                     | Target position is reached in touch probe position mode.                            |
| [227]  | Touch activated     | Touch probe positioning is active. The drive monitors the touch probe sensor input. |
| [228]  | Comparator 6        |   |
| [229]  | Comparator 7        |   |
| [230]  | Comparator 8        |   |
| [231]  | Comparator 9        |   |
| [232]  | Logic rule 6        |   |
| [233]  | Logic rule 7        |   |
| [234]  | Logic rule 8        |   |
| [235]  | Logic rule 9        |   |
| [236]  | SL time-out 8       |   |
| [237]  | SL time-out 9       |   |
| [238]  | RS flipflop 8       |   |
| [239]  | RS flipflop 9       |   |
| [240]  | SL digital output A |   |
| [241]  | SL digital output B |   |
| [242]  | SL digital output C |   |
| [243]  | SL digital output D |   |
| [244]  | SL digital output E |   |
| [245]  | SL digital output F |   |

## Parameter 13-41 Logic Rule Operator 1

Table 682: Parameter 13-41 Logic Rule Operator 1

| 13-41 Logic Rule Operator 1 |                                    |                               |
|-----------------------------|------------------------------------|-------------------------------|
| Default value: Size related | Parameter type: Option, Array [10] | Setup: 2 setups               |
| Conversion index: -         | Data type: Uint8                   | Change during operation: True |

Select the 1<sup>st</sup> logical operator to use on the boolean inputs from *parameter 13-40 Logic Rule Boolean 1* and *parameter 13-42 Logic Rule Boolean 2*. Parameter numbers in square brackets stand for the boolean inputs of parameters in *parameter group 13-\*\* Smart Logic Control*.

| Option | Name     | Description   |
|--------|----------|---|
| [0]    | DISABLED | Ignores <ul style="list-style-type: none"> <li>• <i>Parameter 13-42 Logic Rule Boolean 2</i>.</li> <li>• <i>Parameter 13-43 Logic Rule Operator 2</i>.</li> <li>• <i>Parameter 13-44 Logic Rule Boolean 3</i>.</li> </ul> |
| [1]    | AND      | Evaluates the expression [13-40] AND [13-42].   |

| Option | Name        | Description   |
|--------|-------------|---|
| [2]    | OR          | Evaluates the expression [13-40] OR [13-42].          |
| [3]    | AND NOT     | Evaluates the expression [13-40] AND NOT [13-42].     |
| [4]    | OR NOT      | Evaluates the expression [13-40] OR NOT [13-42].      |
| [5]    | NOT AND     | Evaluates the expression NOT [13-40] AND [13-42].     |
| [6]    | NOT OR      | Evaluates the expression NOT [13-40] OR [13-42].      |
| [7]    | NOT AND NOT | Evaluates the expression NOT [13-40] AND NOT [13-42]. |
| [8]    | NOT OR NOT  | Evaluates the expression NOT [13-40] OR NOT [13-42].  |

## Parameter 13-42: Logic Rule Boolean 2

Table 683: Parameter 13-42 Logic Rule Boolean 2

| 13-42 Logic Rule Boolean 2  |                                    |                               |
|-----------------------------|------------------------------------|-------------------------------|
| Default value: Size related | Parameter type: Option, Array [10] | Setup: 2 setups               |
| Conversion index: -         | Data type: Uint8                   | Change during operation: True |

| Option | Name                 | Description  |
|--------|----------------------|--|
| [0]    | False                | Select the 2 <sup>nd</sup> boolean (true or false) input for the selected logic rule. See <i>parameter 13-01 Start Event</i> and <i>parameter 13-02 Stop Event</i> for more information. |
| [1]    | True                 |  |
| [2]    | Running              |  |
| [3]    | In range             |  |
| [4]    | On reference         |  |
| [5]    | Torque limit         |  |
| [6]    | Current limit        |  |
| [7]    | Out of current range |  |
| [8]    | Below I low          |  |
| [9]    | Above I high         |  |
| [10]   | Out of speed range   |  |
| [11]   | Below speed low      |  |
| [12]   | Above speed high     |  |
| [13]   | Out of feedb. range  |  |
| [14]   | Below feedb. low     |  |
| [15]   | Above feedb. high    |  |
| [16]   | Thermal warning      |  |
| [17]   | Mains out of range   |  |
| [18]   | Reversing            |  |

| Option | Name               | Description   |
|--------|--------------------|---|
| [19]   | Warning            |   |
| [20]   | Alarm (trip)       |   |
| [21]   | Alarm (trip lock)  |   |
| [22]   | Comparator 0       |   |
| [23]   | Comparator 1       |   |
| [24]   | Comparator 2       |   |
| [25]   | Comparator 3       |   |
| [26]   | Logic rule 0       |   |
| [27]   | Logic rule 1       |   |
| [28]   | Logic rule 2       |   |
| [29]   | Logic rule 3       |   |
| [30]   | SL time-out 0      |   |
| [31]   | SL time-out 1      |   |
| [32]   | SL time-out 2      |   |
| [33]   | Digital input DI18 |   |
| [34]   | Digital input DI19 |   |
| [35]   | Digital input DI27 |   |
| [36]   | Digital input DI29 | <div style="text-align: center; background-color: #cccccc; padding: 5px;"><b>NOTICE</b></div> <p>This option is only available in FC 302.</p> |
| [37]   | Digital input DI32 |   |
| [38]   | Digital input DI33 |   |
| [39]   | Start command      |   |
| [40]   | Drive stopped      |   |
| [41]   | Reset trip         |   |
| [42]   | Auto-reset trip    |   |
| [43]   | OK key             | [OK] is pressed. Only available on the graphical LCP.   |
| [44]   | Reset key          | [Reset] is pressed. Only available on the graphical LCP.  |
| [45]   | Left key           | [◀] is pressed. Only available on the graphical LCP.  |
| [46]   | Right key          | [▶] is pressed. Only available on the graphical LCP.  |
| [47]   | Up key             | [▲] is pressed. Only available on the graphical LCP.  |
| [48]   | Down key           | [▼] is pressed. Only available on the graphical LCP.  |

| Option | Name                   | Description  |
|--------|------------------------|--|
| [50]   | Comparator 4           | Use the result of comparator 4.  |
| [51]   | Comparator 5           | Use the result of comparator 5.  |
| [60]   | Logic rule 4           | Use the result of logic rule 4.  |
| [61]   | Logic rule 5           | Use the result of logic rule 5.  |
| [70]   | SL time-out 3          |  |
| [71]   | SL time-out 4          |  |
| [72]   | SL time-out 5          |  |
| [73]   | SL time-out 6          |  |
| [74]   | SL time-out 7          |  |
| [75]   | Start command given    |  |
| [76]   | Digital input X30/2    |  |
| [77]   | Digital input X30/3    |  |
| [78]   | Digital input X30/4    |  |
| [79]   | Digital input X46/1    |  |
| [80]   | Digital input X46/3    |  |
| [81]   | Digital input X46/5    |  |
| [82]   | Digital input X46/7    |  |
| [83]   | Digital input X46/9    |  |
| [84]   | Digital input X46/11   |  |
| [85]   | Digital input X46/13   |  |
| [90]   | ATEX ETR cur. warning  | Available if <i>parameter 1-90 Motor Thermal Protection</i> is set to [20] ATEX ETR or [21] Advanced ETR. If <i>alarm 164, ATEX ETR cur.lim.alarm</i> is active, the output is 1.      |
| [91]   | ATEX ETR cur. alarm    | Available if <i>parameter 1-90 Motor Thermal Protection</i> is set to [20] ATEX ETR or [21] Advanced ETR. If <i>alarm 166, ATEX ETR freq.lim.alarm</i> is active, the output is 1.     |
| [92]   | ATEX ETR freq. warning | Available if <i>parameter 1-90 Motor Thermal Protection</i> is set to [20] ATEX ETR or [21] Advanced ETR. If <i>alarm 163, ATEX ETR cur.lim.warning</i> is active, the output is 1.    |
| [93]   | ATEX ETR freq. alarm   | Available if <i>parameter 1-90 Motor Thermal Protection</i> is set to [20] ATEX ETR or [21] Advanced ETR. If <i>warning 165, ATEX ETR freq.lim.warning</i> is active, the output is 1. |
| [94]   | RS Flipflop 0          | See <i>parameter group 13-1* Comparators</i> .   |
| [95]   | RS Flipflop 1          | See <i>parameter group 13-1* Comparators</i> .   |
| [96]   | RS Flipflop 2          | See <i>parameter group 13-1* Comparators</i> .   |
| [97]   | RS Flipflop 3          | See <i>parameter group 13-1* Comparators</i> .   |
| [98]   | RS Flipflop 4          | See <i>parameter group 13-1* Comparators</i> .   |
| [99]   | RS Flipflop 5          | See <i>parameter group 13-1* Comparators</i> .   |

| Option | Name            | Description  |
|--------|-----------------|--|
| [100]  | RS Flipflop 6   | See <i>parameter group 13-1* Comparators</i> .   |
| [101]  | RS Flipflop 7   | See <i>parameter group 13-1* Comparators</i> .   |
| [102]  | Relay 1         |  |
| [103]  | Relay 2         |  |
| [104]  | Relay 3         | X47/VLT® Extended Relay Card MCB 113.  |
| [105]  | Relay 4         | X47/VLT® Extended Relay Card MCB 113.  |
| [106]  | Relay 5         | X47/VLT® Extended Relay Card MCB 113.  |
| [107]  | Relay 6         | X47/VLT® Extended Relay Card MCB 113.  |
| [108]  | Relay 7         | X34/VLT® Relay Card MCB 105.   |
| [109]  | Relay 8         | X34/VLT® Relay Card MCB 105.   |
| [110]  | Relay 9         | X34/VLT® Relay Card MCB 105.   |
| [212]  | Emergency mode  |  |
| [222]  | Homing OK       | <p style="text-align: center;"><b>NOTICE</b></p> <p>This option is only available with software version 48.2X or newer.</p> <p>Homing is completed with the selected homing function (<i>parameter 17-80 Homing Function</i>).</p>   |
| [223]  | On target       | <p style="text-align: center;"><b>NOTICE</b></p> <p>This option is only available with software version 48.2X or newer.</p> <p>Positioning is completed and the on target signal is sent when the actual position is within <i>parameter 3-05 On Reference Window</i> for the duration of <i>parameter 3-09 On Target Time</i> and the actual speed does not exceed <i>parameter 3-05 On Reference Window</i>.</p> |
| [224]  | Position error  | <p style="text-align: center;"><b>NOTICE</b></p> <p>This option is only available with software version 48.2X or newer.</p> <p>The position error exceeds the value in <i>parameter 4-71 Maximum Position Error</i> for the time set in <i>parameter 4-72 Position Error Timeout</i>.</p>  |
| [225]  | Position limit  | <p style="text-align: center;"><b>NOTICE</b></p> <p>This option is only available with software version 48.2X or newer.</p> <p>The position is outside the limits set in <i>parameter 3-06 Minimum Position</i> and <i>parameter 3-07 Maximum Position</i>.</p>  |
| [226]  | Touch on target | <p style="text-align: center;"><b>NOTICE</b></p> <p>This option is only available with software version 48.2X or newer.</p>  |

| Option | Name                | Description   |
|--------|---------------------|---|
|        |                     | Target position is reached in touch probe position mode.                            |
| [227]  | Touch activated     | Touch probe positioning is active. The drive monitors the touch probe sensor input. |
| [228]  | Comparator 6        |   |
| [229]  | Comparator 7        |   |
| [230]  | Comparator 8        |   |
| [231]  | Comparator 9        |   |
| [232]  | Logic rule 6        |   |
| [233]  | Logic rule 7        |   |
| [234]  | Logic rule 8        |   |
| [235]  | Logic rule 9        |   |
| [236]  | SL time-out 8       |   |
| [237]  | SL time-out 9       |   |
| [238]  | RS flipflop 8       |   |
| [239]  | RS flipflop 9       |   |
| [240]  | SL digital output A |   |
| [241]  | SL digital output B |   |
| [242]  | SL digital output C |   |
| [243]  | SL digital output D |   |
| [244]  | SL digital output E |   |
| [245]  | SL digital output F |   |

Parameter 13-43 Logic Rule Operator 2

Table 684: Parameter 13-43 Logic Rule Operator 2

| 13-43 Logic Rule Operator 2 |                                    |                               |
|-----------------------------|------------------------------------|-------------------------------|
| Default value: Size related | Parameter type: Option, Array [10] | Setup: 2 setups               |
| Conversion index: -         | Data type: Uint8                   | Change during operation: True |

Select the 2<sup>nd</sup> logical operator to be used on the boolean input calculated in:

- Parameter 13-40 Logic Rule Boolean 1.
- Parameter 13-41 Logic Rule Operator 1.
- Parameter 13-42 Logic Rule Boolean 2.

[13-44] signifies the boolean input of parameter 13-44 Logic Rule Boolean 3. [13-40/13-42] signifies the boolean input calculated in:

- Parameter 13-40 Logic Rule Boolean 1.
- Parameter 13-41 Logic Rule Operator 1.
- Parameter 13-42 Logic Rule Boolean 2.



| Option | Name        | Description |
|--------|-------------|-------------|
| [0]    | DISABLED    |             |
| [1]    | AND         |             |
| [2]    | OR          |             |
| [3]    | AND NOT     |             |
| [4]    | OR NOT      |             |
| [5]    | NOT AND     |             |
| [6]    | NOT OR      |             |
| [7]    | NOT AND NOT |             |
| [8]    | NOT OR NOT  |             |

## Parameter 13-44 Logic Rule Boolean 3

Table 685: Parameter 13-44 Logic Rule Boolean 3

| 13-44 Logic Rule Boolean 3  |                                    |                               |
|-----------------------------|------------------------------------|-------------------------------|
| Default value: Size related | Parameter type: Option, Array [10] | Setup: 2 setups               |
| Conversion index: -         | Data type: Uint8                   | Change during operation: True |

| Option | Name                 | Description  |
|--------|----------------------|--|
| [0]    | False                | Select the 3 <sup>rd</sup> boolean (true or false) input for the selected logic rule. See <i>parameter 13-01 Start Event</i> (options [0] False–[61] Logic rule 5) and <i>parameter 13-02 Stop Event</i> (options [70] SL Time-out 3–[75] Start command given) for more information. |
| [1]    | True                 |  |
| [2]    | Running              |  |
| [3]    | In range             |  |
| [4]    | On reference         |  |
| [5]    | Torque limit         |  |
| [6]    | Current limit        |  |
| [7]    | Out of current range |  |
| [8]    | Below I low          |  |
| [9]    | Above I high         |  |
| [10]   | Out of speed range   |  |
| [11]   | Below speed low      |  |
| [12]   | Above speed high     |  |
| [13]   | Out of feedb. range  |  |
| [14]   | Below feedb. low     |  |
| [15]   | Above feedb. high    |  |

| Option | Name               | Description   |
|--------|--------------------|---|
| [16]   | Thermal warning    |   |
| [17]   | Mains out of range |   |
| [18]   | Reversing          |   |
| [19]   | Warning            |   |
| [20]   | Alarm (trip)       |   |
| [21]   | Alarm (trip lock)  |   |
| [22]   | Comparator 0       |   |
| [23]   | Comparator 1       |   |
| [24]   | Comparator 2       |   |
| [25]   | Comparator 3       |   |
| [26]   | Logic rule 0       |   |
| [27]   | Logic rule 1       |   |
| [28]   | Logic rule 2       |   |
| [29]   | Logic rule 3       |   |
| [30]   | SL time-out 0      |   |
| [31]   | SL time-out 1      |   |
| [32]   | SL time-out 2      |   |
| [33]   | Digital input DI18 |   |
| [34]   | Digital input DI19 |   |
| [35]   | Digital input DI27 |   |
| [36]   | Digital input DI29 | <div style="text-align: center; background-color: #cccccc; padding: 5px;"><b>NOTICE</b></div> <p>This option is only available in FC 302.</p> |
| [37]   | Digital input DI32 |   |
| [38]   | Digital input DI33 |   |
| [39]   | Start command      |   |
| [40]   | Drive stopped      |   |
| [41]   | Reset trip         |   |
| [42]   | Auto-reset trip    |   |
| [43]   | OK key             | [OK] is pressed. Only available on the graphical LCP.   |
| [44]   | Reset key          | [Reset] is pressed. Only available on the graphical LCP.  |
| [45]   | Left key           | [◀] is pressed. Only available on the graphical LCP.  |

| Option | Name                   | Description  |
|--------|------------------------|--|
| [46]   | Right key              | [>] is pressed. Only available on the graphical LCP.   |
| [47]   | Up key                 | [^] is pressed. Only available on the graphical LCP.   |
| [48]   | Down key               | [v] is pressed. Only available on the graphical LCP.   |
| [50]   | Comparator 4           | Use the result of comparator 4.  |
| [51]   | Comparator 5           | Use the result of comparator 5.  |
| [60]   | Logic rule 4           | Use the result of logic rule 4.  |
| [61]   | Logic rule 5           | Use the result of logic rule 5.  |
| [70]   | SL time-out 3          |  |
| [71]   | SL time-out 4          |  |
| [72]   | SL time-out 5          |  |
| [73]   | SL time-out 6          |  |
| [74]   | SL time-out 7          |  |
| [75]   | Start command given    |  |
| [76]   | Digital input X30/2    |  |
| [77]   | Digital input X30/3    |  |
| [78]   | Digital input X30/4    |  |
| [79]   | Digital input X46/1    |  |
| [80]   | Digital input X46/3    |  |
| [81]   | Digital input X46/5    |  |
| [82]   | Digital input X46/7    |  |
| [83]   | Digital input X46/9    |  |
| [84]   | Digital input X46/11   |  |
| [85]   | Digital input X46/13   |  |
| [90]   | ATEX ETR cur. warning  | Available if <i>parameter 1-90 Motor Thermal Protection</i> is set to [20] ATEX ETR or [21] Advanced ETR. If <i>alarm 164, ATEX ETR cur.lim.alarm</i> is active, the output is 1.      |
| [91]   | ATEX ETR cur. alarm    | Available if <i>parameter 1-90 Motor Thermal Protection</i> is set to [20] ATEX ETR or [21] Advanced ETR. If <i>alarm 166, ATEX ETR freq.lim.alarm</i> is active, the output is 1.     |
| [92]   | ATEX ETR freq. warning | Available if <i>parameter 1-90 Motor Thermal Protection</i> is set to [20] ATEX ETR or [21] Advanced ETR. If <i>alarm 163, ATEX ETR cur.lim.warning</i> is active, the output is 1.    |
| [93]   | ATEX ETR freq. alarm   | Available if <i>parameter 1-90 Motor Thermal Protection</i> is set to [20] ATEX ETR or [21] Advanced ETR. If <i>warning 165, ATEX ETR freq.lim.warning</i> is active, the output is 1. |
| [94]   | RS Flipflop 0          | See <i>parameter group 13-1* Comparators</i> .   |
| [95]   | RS Flipflop 1          | See <i>parameter group 13-1* Comparators</i> .   |
| [96]   | RS Flipflop 2          | See <i>parameter group 13-1* Comparators</i> .   |

| Option | Name           | Description  |
|--------|----------------|--|
| [97]   | RS Flipflop 3  | See <i>parameter group 13-1* Comparators</i> .   |
| [98]   | RS Flipflop 4  | See <i>parameter group 13-1* Comparators</i> .   |
| [99]   | RS Flipflop 5  | See <i>parameter group 13-1* Comparators</i> .   |
| [100]  | RS Flipflop 6  | See <i>parameter group 13-1* Comparators</i> .   |
| [101]  | RS Flipflop 7  | See <i>parameter group 13-1* Comparators</i> .   |
| [102]  | Relay 1        |  |
| [103]  | Relay 2        |  |
| [104]  | Relay 3        | X47/VLT® Extended Relay Card MCB 113.  |
| [105]  | Relay 4        | X47/VLT® Extended Relay Card MCB 113.  |
| [106]  | Relay 5        | X47/VLT® Extended Relay Card MCB 113.  |
| [107]  | Relay 6        | X47/VLT® Extended Relay Card MCB 113.  |
| [108]  | Relay 7        | X34/VLT® Relay Card MCB 105.   |
| [109]  | Relay 8        | X34/VLT® Relay Card MCB 105.   |
| [110]  | Relay 9        | X34/VLT® Relay Card MCB 105.   |
| [212]  | Emergency mode |  |
| [222]  | Homing OK      | <p style="text-align: center;"><b>NOTICE</b></p> <p>This option is only available with software version 48.2X or newer.</p> <p>Homing is completed with the selected homing function (<i>parameter 17-80 Homing Function</i>).</p>   |
| [223]  | On target      | <p style="text-align: center;"><b>NOTICE</b></p> <p>This option is only available with software version 48.2X or newer.</p> <p>Positioning is completed and the on target signal is sent when the actual position is within <i>parameter 3-05 On Reference Window</i> for the duration of <i>parameter 3-09 On Target Time</i> and the actual speed does not exceed <i>parameter 3-05 On Reference Window</i>.</p> |
| [224]  | Position error | <p style="text-align: center;"><b>NOTICE</b></p> <p>This option is only available with software version 48.2X or newer.</p> <p>The position error exceeds the value in <i>parameter 4-71 Maximum Position Error</i> for the time set in <i>parameter 4-72 Position Error Timeout</i>.</p>  |
| [225]  | Position limit | <p style="text-align: center;"><b>NOTICE</b></p> <p>This option is only available with software version 48.2X or newer.</p> <p>The position is outside the limits set in <i>parameter 3-06 Minimum Position</i> and <i>parameter 3-07 Maximum Position</i>.</p>  |

| Option | Name                | Description  |
|--------|---------------------|--|
| [226]  | Touch on target     | <div style="text-align: center; background-color: #cccccc; padding: 5px;"><b>NOTICE</b></div> <p>This option is only available with software version 48.2X or newer.</p> <p>Target position is reached in touch probe position mode.</p> |
| [227]  | Touch activated     | Touch probe positioning is active. The drive monitors the touch probe sensor input.  |
| [228]  | Comparator 6        |  |
| [229]  | Comparator 7        |  |
| [230]  | Comparator 8        |  |
| [231]  | Comparator 9        |  |
| [232]  | Logic rule 6        |  |
| [233]  | Logic rule 7        |  |
| [234]  | Logic rule 8        |  |
| [235]  | Logic rule 9        |  |
| [236]  | SL time-out 8       |  |
| [237]  | SL time-out 9       |  |
| [238]  | RS flipflop 8       |  |
| [239]  | RS flipflop 9       |  |
| [240]  | SL digital output A |  |
| [241]  | SL digital output B |  |
| [242]  | SL digital output C |  |
| [243]  | SL digital output D |  |
| [244]  | SL digital output E |  |
| [245]  | SL digital output F |  |

### 5.13.5 13-5\* States

#### Parameter 13-51 SL Controller Event

Table 686: Parameter 13-51 SL Controller Event

| 13-51 SL Controller Event   |                                    |                               |
|-----------------------------|------------------------------------|-------------------------------|
| Default value: Size related | Parameter type: Option, Array [20] | Setup: 2 setups               |
| Conversion index: -         | Data type: Uint8                   | Change during operation: True |

| Option | Name                 | Description   |
|--------|----------------------|---|
| [0]    | False                | Select the boolean input (true or false) to define the smart logic controller event. See <i>parameter 13-01 Start Event</i> (options [0] False–[61] Logic rule 5) and <i>parameter 13-02 Stop Event</i> (options [70] SL Time-out 3–[74] SL Time-out 7) for more information. |
| [1]    | True                 |   |
| [2]    | Running              |   |
| [3]    | In range             |   |
| [4]    | On reference         |   |
| [5]    | Torque limit         |   |
| [6]    | Current limit        |   |
| [7]    | Out of current range |   |
| [8]    | Below I low          |   |
| [9]    | Above I high         |   |
| [10]   | Out of speed range   |   |
| [11]   | Below speed low      |   |
| [12]   | Above speed high     |   |
| [13]   | Out of feedb. range  |   |
| [14]   | Below feedb. low     |   |
| [15]   | Above feedb. high    |   |
| [16]   | Thermal warning      |   |
| [17]   | Mains out of range   |   |
| [18]   | Reversing            |   |
| [19]   | Warning              |   |
| [20]   | Alarm (trip)         |   |
| [21]   | Alarm (trip lock)    |   |
| [22]   | Comparator 0         |   |
| [23]   | Comparator 1         |   |
| [24]   | Comparator 2         |   |
| [25]   | Comparator 3         |   |
| [26]   | Logic rule 0         |   |
| [27]   | Logic rule 1         |   |
| [28]   | Logic rule 2         |   |
| [29]   | Logic rule 3         |   |
| [30]   | SL time-out 0        |   |

| Option | Name                | Description  |
|--------|---------------------|--|
| [31]   | SL time-out 1       |  |
| [32]   | SL time-out 2       |  |
| [33]   | Digital input DI18  |  |
| [34]   | Digital input DI19  |  |
| [35]   | Digital input DI27  |  |
| [36]   | Digital input DI29  | <div style="text-align: center; background-color: #cccccc; padding: 5px;"><b>NOTICE</b></div> <div style="border: 1px solid #ccc; padding: 5px; margin-top: 5px;">This option is only available in FC 302.</div> |
| [37]   | Digital input DI32  |  |
| [38]   | Digital input DI33  |  |
| [39]   | Start command       |  |
| [40]   | Drive stopped       |  |
| [41]   | Reset trip          |  |
| [42]   | Auto-reset trip     |  |
| [43]   | OK key              | [OK] is pressed. Only available on the graphical LCP.  |
| [44]   | Reset key           | [Reset] is pressed. Only available on the graphical LCP.   |
| [45]   | Left key            | [◀] is pressed. Only available on the graphical LCP.   |
| [46]   | Right key           | [▶] is pressed. Only available on the graphical LCP.   |
| [47]   | Up key              | [▲] is pressed. Only available on the graphical LCP.   |
| [48]   | Down key            | [▼] is pressed. Only available on the graphical LCP.   |
| [50]   | Comparator 4        | Use the result of comparator 4.  |
| [51]   | Comparator 5        | Use the result of comparator 5.  |
| [60]   | Logic rule 4        | Use the result of logic rule 4.  |
| [61]   | Logic rule 5        | Use the result of logic rule 5.  |
| [70]   | SL time-out 3       |  |
| [71]   | SL time-out 4       |  |
| [72]   | SL time-out 5       |  |
| [73]   | SL time-out 6       |  |
| [74]   | SL time-out 7       |  |
| [75]   | Start command given |  |
| [76]   | Digital input X30/2 |  |
| [77]   | Digital input X30/3 |  |

| Option | Name                   | Description  |
|--------|------------------------|--|
| [78]   | Digital input X30/4    |  |
| [79]   | Digital input X46/1    |  |
| [80]   | Digital input X46/3    |  |
| [81]   | Digital input X46/5    |  |
| [82]   | Digital input X46/7    |  |
| [83]   | Digital input X46/9    |  |
| [84]   | Digital input X46/11   |  |
| [85]   | Digital input X46/13   |  |
| [90]   | ATEX ETR cur. warning  | Available if <i>parameter 1-90 Motor Thermal Protection</i> is set to [20] ATEX ETR or [21] Advanced ETR. If <i>alarm 164, ATEX ETR cur.lim.alarm</i> is active, the output is 1.      |
| [91]   | ATEX ETR cur. alarm    | Available if <i>parameter 1-90 Motor Thermal Protection</i> is set to [20] ATEX ETR or [21] Advanced ETR. If <i>alarm 166, ATEX ETR freq.lim.alarm</i> is active, the output is 1.     |
| [92]   | ATEX ETR freq. warning | Available if <i>parameter 1-90 Motor Thermal Protection</i> is set to [20] ATEX ETR or [21] Advanced ETR. If <i>alarm 163, ATEX ETR cur.lim.warning</i> is active, the output is 1.    |
| [93]   | ATEX ETR freq. alarm   | Available if <i>parameter 1-90 Motor Thermal Protection</i> is set to [20] ATEX ETR or [21] Advanced ETR. If <i>warning 165, ATEX ETR freq.lim.warning</i> is active, the output is 1. |
| [94]   | RS Flipflop 0          | See <i>parameter group 13-1* Comparators</i> .   |
| [95]   | RS Flipflop 1          | See <i>parameter group 13-1* Comparators</i> .   |
| [96]   | RS Flipflop 2          | See <i>parameter group 13-1* Comparators</i> .   |
| [97]   | RS Flipflop 3          | See <i>parameter group 13-1* Comparators</i> .   |
| [98]   | RS Flipflop 4          | See <i>parameter group 13-1* Comparators</i> .   |
| [99]   | RS Flipflop 5          | See <i>parameter group 13-1* Comparators</i> .   |
| [100]  | RS Flipflop 6          | See <i>parameter group 13-1* Comparators</i> .   |
| [101]  | RS Flipflop 7          | See <i>parameter group 13-1* Comparators</i> .   |
| [102]  | Relay 1                |  |
| [103]  | Relay 2                |  |
| [104]  | Relay 3                | X47/VLT® Extended Relay Card MCB 113.  |
| [105]  | Relay 4                | X47/VLT® Extended Relay Card MCB 113.  |
| [106]  | Relay 5                | X47/VLT® Extended Relay Card MCB 113.  |
| [107]  | Relay 6                | X47/VLT® Extended Relay Card MCB 113.  |
| [108]  | Relay 7                | X34/VLT® Relay Card MCB 105.   |
| [109]  | Relay 8                | X34/VLT® Relay Card MCB 105.   |
| [110]  | Relay 9                | X34/VLT® Relay Card MCB 105.   |
| [212]  | Emergency mode         |  |



| Option | Name            | Description  |
|--------|-----------------|--|
| [222]  | Homing OK       | <p style="text-align: center;"><b>NOTICE</b></p> <p>This option is only available with software version 48.2X or newer.</p> <p>Homing is completed with the selected homing function (<i>parameter 17-80 Homing Function</i>).</p>   |
| [223]  | On target       | <p style="text-align: center;"><b>NOTICE</b></p> <p>This option is only available with software version 48.2X or newer.</p> <p>Positioning is completed and the on target signal is sent when the actual position is within <i>parameter 3-05 On Reference Window</i> for the duration of <i>parameter 3-09 On Target Time</i> and the actual speed does not exceed <i>parameter 3-05 On Reference Window</i>.</p> |
| [224]  | Position error  | <p style="text-align: center;"><b>NOTICE</b></p> <p>This option is only available with software version 48.2X or newer.</p> <p>The position error exceeds the value in <i>parameter 4-71 Maximum Position Error</i> for the time set in <i>parameter 4-72 Position Error Timeout</i>.</p>  |
| [225]  | Position limit  | <p style="text-align: center;"><b>NOTICE</b></p> <p>This option is only available with software version 48.2X or newer.</p> <p>The position is outside the limits set in <i>parameter 3-06 Minimum Position</i> and <i>parameter 3-07 Maximum Position</i>.</p>  |
| [226]  | Touch on target | <p style="text-align: center;"><b>NOTICE</b></p> <p>This option is only available with software version 48.2X or newer.</p> <p>Target position is reached in touch probe position mode.</p>  |
| [227]  | Touch activated | Touch probe positioning is active. The drive monitors the touch probe sensor input.  |
| [228]  | Comparator 6    |  |
| [229]  | Comparator 7    |  |
| [230]  | Comparator 8    |  |
| [231]  | Comparator 9    |  |
| [232]  | Logic rule 6    |  |
| [233]  | Logic rule 7    |  |
| [234]  | Logic rule 8    |  |
| [235]  | Logic rule 9    |  |
| [236]  | SL time-out 8   |  |
| [237]  | SL time-out 9   |  |

| Option | Name                | Description |
|--------|---------------------|-------------|
| [238]  | RS flipflop 8       |             |
| [239]  | RS flipflop 9       |             |
| [240]  | SL digital output A |             |
| [241]  | SL digital output B |             |
| [242]  | SL digital output C |             |
| [243]  | SL digital output D |             |
| [244]  | SL digital output E |             |
| [245]  | SL digital output F |             |

## Parameter 13-52 SL Controller Action

Table 687: Parameter 13-52 SL Controller Action

| 13-52 SL Controller Action  |                                    |                               |
|-----------------------------|------------------------------------|-------------------------------|
| Default value: Size related | Parameter type: Option, Array [20] | Setup: 2 setups               |
| Conversion index: -         | Data type: Uint8                   | Change during operation: True |

Select the action corresponding to the SLC event. Actions are executed when the corresponding event (defined in *parameter 13-51 SL Controller 1 Event*) is evaluated as true.

| Option | Name                | Description  |
|--------|---------------------|--|
| [0]    | DISABLED            |  |
| [1]    | No action           |  |
| [2]    | Select set-up 1     | Changes the active setup ( <i>parameter 0-10 Active Set-up</i> ) to 1. If the setup is changed, it merges with other setup commands coming from either the digital inputs or via a fieldbus. |
| [3]    | Select set-up 2     | Changes the active setup ( <i>parameter 0-10 Active Set-up</i> ) to 2. If the setup is changed, it merges with other setup commands coming from either the digital inputs or via a fieldbus. |
| [4]    | Select set-up 3     | Changes the active setup ( <i>parameter 0-10 Active Set-up</i> ) to 3. If the setup is changed, it merges with other setup commands coming from either the digital inputs or via a fieldbus. |
| [5]    | Select set-up 4     | Changes the active setup ( <i>parameter 0-10 Active Set-up</i> ) to 4. If the setup is changed, it merges with other setup commands coming from either the digital inputs or via a fieldbus. |
| [10]   | Select preset ref 0 | Selects preset reference 0. If the active preset reference is changed, it merges with other preset reference commands coming from either the digital inputs or via a fieldbus.               |
| [11]   | Select preset ref 1 | Selects preset reference 1. If the active preset reference is changed, it merges with other preset reference commands coming from either the digital inputs or via a fieldbus.               |
| [12]   | Select preset ref 2 | Selects preset reference 2. If the active preset reference is changed, it merges with other preset reference commands coming from either the digital inputs or via a fieldbus.               |
| [13]   | Select preset ref 3 | Selects preset reference 3. If the active preset reference is changed, it merges with other preset reference commands coming from either the digital inputs or via a fieldbus.               |
| [14]   | Select preset ref 4 | Selects preset reference 4. If the active preset reference is changed, it merges with other preset reference commands coming from either the digital inputs or via a fieldbus.               |

| Option | Name                   | Description  |
|--------|------------------------|--|
| [15]   | Select preset ref 5    | Selects preset reference 5. If the active preset reference is changed, it merges with other preset reference commands coming from either the digital inputs or via a fieldbus. |
| [16]   | Select preset ref 6    | Selects preset reference 6. If the active preset reference is changed, it merges with other preset reference commands coming from either the digital inputs or via a fieldbus. |
| [17]   | Select preset ref 7    | Selects preset reference 7. If the active preset reference is changed, it merges with other preset reference commands coming from either the digital inputs or via a fieldbus. |
| [18]   | Select ramp 1          | Selects ramp 1.  |
| [19]   | Select ramp 2          | Selects ramp 2.  |
| [20]   | Select ramp 3          | Selects ramp 3.  |
| [21]   | Select ramp 4          | Selects ramp 4.  |
| [22]   | Run                    | Issues a start command to the drive.   |
| [23]   | Run reverse            | Issues a start reverse command to the drive.   |
| [24]   | Stop                   | Issues a stop command to the drive.  |
| [25]   | Qstop                  | Issues a quick stop command to the drive.  |
| [26]   | Dcstop                 | Issues a DC stop command to the drive.   |
| [27]   | Coast                  | The drive coasts immediately. All stop commands including the coast command stop the SLC.  |
| [28]   | Freeze output          | Freezes the output frequency of the drive.   |
| [29]   | Start timer 0          | Starts timer 0, see <i>parameter 13-20 SL Controller Timer</i> for further description.  |
| [30]   | Start timer 1          | Starts timer 1, see <i>parameter 13-20 SL Controller Timer</i> for further description.  |
| [31]   | Start timer 2          | Starts timer 2, see <i>parameter 13-20 SL Controller Timer</i> for further description.  |
| [32]   | Set digital out A low  | Any output with smart logic output A is low.   |
| [33]   | Set digital out B low  | Any output with smart logic output B is low.   |
| [34]   | Set digital out C low  | Any output with smart logic output C is low.   |
| [35]   | Set digital out D low  | Any output with smart logic output D is low.   |
| [36]   | Set digital out E low  | Any output with smart logic output E is low.   |
| [37]   | Set digital out F low  | Any output with smart logic output F is low.   |
| [38]   | Set digital out A high | Any output with smart logic output A is high.  |
| [39]   | Set digital out B high | Any output with smart logic output B is high.  |
| [40]   | Set digital out C high | Any output with smart logic output C is high.  |
| [41]   | Set digital out D high | Any output with smart logic output D is high.  |
| [42]   | Set digital out E high | Any output with smart logic output E is high.  |
| [43]   | Set digital out F high | Any output with smart logic output F is high.  |
| [60]   | Reset Counter A        | Resets counter A to 0.   |
| [61]   | Reset Counter B        | Resets counter B to 0.   |

| Option | Name              | Description  |
|--------|-------------------|--|
| [62]   | Counter A (up)    |  |
| [63]   | Counter A (down)  |  |
| [64]   | Counter B (up)    |  |
| [65]   | Counter B (down)  |  |
| [70]   | Start timer 3     | Starts timer 3, see <i>parameter 13-20 SL Controller Timer</i> for further description.  |
| [71]   | Start timer 4     | Starts timer 4, see <i>parameter 13-20 SL Controller Timer</i> for further description.  |
| [72]   | Start timer 5     | Starts timer 5, see <i>parameter 13-20 SL Controller Timer</i> for further description.  |
| [73]   | Start timer 6     | Starts timer 6, see <i>parameter 13-20 SL Controller Timer</i> for further description.  |
| [74]   | Start timer 7     | Starts timer 7, see <i>parameter 13-20 SL Controller Timer</i> for further description.  |
| [120]  | Start homing      | <p style="text-align: center;"><b>NOTICE</b></p> <p>This option is available only with software version 48.20 and newer.</p> <p>Activates the homing mode and starts the homing function selected in <i>parameter 17-80 Homing Function</i>. Must remain active until the homing is completed otherwise the homing is aborted.</p> |
| [121]  | Stop homing       | <p style="text-align: center;"><b>NOTICE</b></p> <p>This option is available only with software version 48.20 and newer.</p> <p>Deactivates the homing mode, an active homing function is aborted if the homing is not completed.</p>  |
| [122]  | Enable reference  | <p style="text-align: center;"><b>NOTICE</b></p> <p>This option is available only with software version 48.20 and newer.</p> <p>Sets the enable reference mode.</p>  |
| [123]  | Disable reference | <p style="text-align: center;"><b>NOTICE</b></p> <p>This option is available only with software version 48.20 and newer.</p> <p>Disables the enable reference mode.</p>  |
| [124]  | Relative position | <p style="text-align: center;"><b>NOTICE</b></p> <p>This option is available only with software version 48.20 and newer.</p> <p>Selects the relative position mode instead of the absolute position mode.</p>  |
| [125]  | Absolute position | <p style="text-align: center;"><b>NOTICE</b></p> <p>This option is available only with software version 48.20 and newer.</p>   |

| Option | Name              | Description  |
|--------|-------------------|--|
|        |                   | Selects the absolute position mode instead of the relative position mode.  |
| [126]  | Activate touch    | <p style="text-align: center;"><b>NOTICE</b></p> <p>This option is available only with software version 48.20 and newer.</p> <p>Activates the touch probe positioning mode.</p>  |
| [127]  | Deactivate touch  | <p style="text-align: center;"><b>NOTICE</b></p> <p>This option is available only with software version 48.20 and newer.</p> <p>Deactivates the touch probe positioning mode.</p>  |
| [128]  | Target inverse    | <p style="text-align: center;"><b>NOTICE</b></p> <p>This option is available only with software version 48.20 and newer.</p> <p>Changes the sign of the active target position value.</p>  |
| [129]  | Target            | <p style="text-align: center;"><b>NOTICE</b></p> <p>This option is available only with software version 48.20 and newer.</p> <p>The active target position is not changed.</p>   |
| [130]  | Act. speed mode   | <p style="text-align: center;"><b>NOTICE</b></p> <p>This option is available only with software version 48.20 and newer.</p> <p>Activates the speed mode when option [9] <i>Positioning</i> or option [10] <i>Synchronization</i> is selected in <i>parameter 1-00 Configuration Mode</i>.</p> |
| [131]  | Deact. speed mode | <p style="text-align: center;"><b>NOTICE</b></p> <p>This option is available only with software version 48.20 and newer.</p> <p>Deactivates the speed mode and activates the option selected in <i>parameter 1-00 Configuration Mode</i>.</p>  |

Parameter 13-53 SL Controller 2 Event

Table 688: Parameter 13-53 SL Controller 2 Event

| 13-53 SL Controller 2 Event |                                    |                               |
|-----------------------------|------------------------------------|-------------------------------|
| Default value: Size related | Parameter type: Option, Array [20] | Setup: 2 setups               |
| Conversion index: -         | Data type: Uint8                   | Change during operation: True |

| Option | Name                 | Description   |
|--------|----------------------|---|
| [0]    | False                | Select the boolean input (true or false) to define the smart logic controller event. See <i>parameter 13-01 Start Event</i> (options [0] False–[61] Logic rule 5) and <i>parameter 13-02 Stop Event</i> (options [70] SL Time-out 3–[74] SL Time-out 7) for more information. |
| [1]    | True                 |   |
| [2]    | Running              |   |
| [3]    | In range             |   |
| [4]    | On reference         |   |
| [5]    | Torque limit         |   |
| [6]    | Current limit        |   |
| [7]    | Out of current range |   |
| [8]    | Below I low          |   |
| [9]    | Above I high         |   |
| [10]   | Out of speed range   |   |
| [11]   | Below speed low      |   |
| [12]   | Above speed high     |   |
| [13]   | Out of feedb. range  |   |
| [14]   | Below feedb. low     |   |
| [15]   | Above feedb. high    |   |
| [16]   | Thermal warning      |   |
| [17]   | Mains out of range   |   |
| [18]   | Reversing            |   |
| [19]   | Warning              |   |
| [20]   | Alarm (trip)         |   |
| [21]   | Alarm (trip lock)    |   |
| [22]   | Comparator 0         |   |
| [23]   | Comparator 1         |   |
| [24]   | Comparator 2         |   |
| [25]   | Comparator 3         |   |
| [26]   | Logic rule 0         |   |
| [27]   | Logic rule 1         |   |
| [28]   | Logic rule 2         |   |
| [29]   | Logic rule 3         |   |
| [30]   | SL time-out 0        |   |

| Option | Name                | Description   |
|--------|---------------------|---|
| [31]   | SL time-out 1       |   |
| [32]   | SL time-out 2       |   |
| [33]   | Digital input DI18  |   |
| [34]   | Digital input DI19  |   |
| [35]   | Digital input DI27  |   |
| [36]   | Digital input DI29  | <div style="text-align: center; background-color: #cccccc; padding: 5px;"><b>NOTICE</b></div> <div style="border: 1px solid black; padding: 5px; margin-top: 5px;">This option is only available in FC 302.</div> |
| [37]   | Digital input DI32  |   |
| [38]   | Digital input DI33  |   |
| [39]   | Start command       |   |
| [40]   | Drive stopped       |   |
| [41]   | Reset trip          |   |
| [42]   | Auto-reset trip     |   |
| [43]   | OK key              | [OK] is pressed. Only available on the graphical LCP.   |
| [44]   | Reset key           | [Reset] is pressed. Only available on the graphical LCP.  |
| [45]   | Left key            | [◀] is pressed. Only available on the graphical LCP.  |
| [46]   | Right key           | [▶] is pressed. Only available on the graphical LCP.  |
| [47]   | Up key              | [▲] is pressed. Only available on the graphical LCP.  |
| [48]   | Down key            | [▼] is pressed. Only available on the graphical LCP.  |
| [50]   | Comparator 4        | Use the result of comparator 4.   |
| [51]   | Comparator 5        | Use the result of comparator 5.   |
| [60]   | Logic rule 4        | Use the result of logic rule 4.   |
| [61]   | Logic rule 5        | Use the result of logic rule 5.   |
| [70]   | SL time-out 3       |   |
| [71]   | SL time-out 4       |   |
| [72]   | SL time-out 5       |   |
| [73]   | SL time-out 6       |   |
| [74]   | SL time-out 7       |   |
| [75]   | Start command given |   |
| [76]   | Digital input X30/2 |   |
| [77]   | Digital input X30/3 |   |

| Option | Name                   | Description  |
|--------|------------------------|--|
| [78]   | Digital input X30/4    |  |
| [79]   | Digital input X46/1    |  |
| [80]   | Digital input X46/3    |  |
| [81]   | Digital input X46/5    |  |
| [82]   | Digital input X46/7    |  |
| [83]   | Digital input X46/9    |  |
| [84]   | Digital input X46/11   |  |
| [85]   | Digital input X46/13   |  |
| [90]   | ATEX ETR cur. warning  | Available if <i>parameter 1-90 Motor Thermal Protection</i> is set to [20] ATEX ETR or [21] Advanced ETR. If <i>alarm 164, ATEX ETR cur.lim.alarm</i> is active, the output is 1.      |
| [91]   | ATEX ETR cur. alarm    | Available if <i>parameter 1-90 Motor Thermal Protection</i> is set to [20] ATEX ETR or [21] Advanced ETR. If <i>alarm 166, ATEX ETR freq.lim.alarm</i> is active, the output is 1.     |
| [92]   | ATEX ETR freq. warning | Available if <i>parameter 1-90 Motor Thermal Protection</i> is set to [20] ATEX ETR or [21] Advanced ETR. If <i>alarm 163, ATEX ETR cur.lim.warning</i> is active, the output is 1.    |
| [93]   | ATEX ETR freq. alarm   | Available if <i>parameter 1-90 Motor Thermal Protection</i> is set to [20] ATEX ETR or [21] Advanced ETR. If <i>warning 165, ATEX ETR freq.lim.warning</i> is active, the output is 1. |
| [94]   | RS Flipflop 0          | See <i>parameter group 13-1* Comparators</i> .   |
| [95]   | RS Flipflop 1          | See <i>parameter group 13-1* Comparators</i> .   |
| [96]   | RS Flipflop 2          | See <i>parameter group 13-1* Comparators</i> .   |
| [97]   | RS Flipflop 3          | See <i>parameter group 13-1* Comparators</i> .   |
| [98]   | RS Flipflop 4          | See <i>parameter group 13-1* Comparators</i> .   |
| [99]   | RS Flipflop 5          | See <i>parameter group 13-1* Comparators</i> .   |
| [100]  | RS Flipflop 6          | See <i>parameter group 13-1* Comparators</i> .   |
| [101]  | RS Flipflop 7          | See <i>parameter group 13-1* Comparators</i> .   |
| [102]  | Relay 1                |  |
| [103]  | Relay 2                |  |
| [104]  | Relay 3                | X47/VLT® Extended Relay Card MCB 113.  |
| [105]  | Relay 4                | X47/VLT® Extended Relay Card MCB 113.  |
| [106]  | Relay 5                | X47/VLT® Extended Relay Card MCB 113.  |
| [107]  | Relay 6                | X47/VLT® Extended Relay Card MCB 113.  |
| [108]  | Relay 7                | X34/VLT® Relay Card MCB 105.   |
| [109]  | Relay 8                | X34/VLT® Relay Card MCB 105.   |
| [110]  | Relay 9                | X34/VLT® Relay Card MCB 105.   |
| [212]  | Emergency mode         |  |



| Option | Name            | Description  |
|--------|-----------------|--|
| [222]  | Homing OK       | <p style="text-align: center;"><b>NOTICE</b></p> <p>This option is only available with software version 48.2X or newer.</p> <p>Homing is completed with the selected homing function (<i>parameter 17-80 Homing Function</i>).</p>   |
| [223]  | On target       | <p style="text-align: center;"><b>NOTICE</b></p> <p>This option is only available with software version 48.2X or newer.</p> <p>Positioning is completed and the on target signal is sent when the actual position is within <i>parameter 3-05 On Reference Window</i> for the duration of <i>parameter 3-09 On Target Time</i> and the actual speed does not exceed <i>parameter 3-05 On Reference Window</i>.</p> |
| [224]  | Position error  | <p style="text-align: center;"><b>NOTICE</b></p> <p>This option is only available with software version 48.2X or newer.</p> <p>The position error exceeds the value in <i>parameter 4-71 Maximum Position Error</i> for the time set in <i>parameter 4-72 Position Error Timeout</i>.</p>  |
| [225]  | Position limit  | <p style="text-align: center;"><b>NOTICE</b></p> <p>This option is only available with software version 48.2X or newer.</p> <p>The position is outside the limits set in <i>parameter 3-06 Minimum Position</i> and <i>parameter 3-07 Maximum Position</i>.</p>  |
| [226]  | Touch on target | <p style="text-align: center;"><b>NOTICE</b></p> <p>This option is only available with software version 48.2X or newer.</p> <p>Target position is reached in touch probe position mode.</p>  |
| [227]  | Touch activated | Touch probe positioning is active. The drive monitors the touch probe sensor input.  |
| [228]  | Comparator 6    |  |
| [229]  | Comparator 7    |  |
| [230]  | Comparator 8    |  |
| [231]  | Comparator 9    |  |
| [232]  | Logic rule 6    |  |
| [233]  | Logic rule 7    |  |
| [234]  | Logic rule 8    |  |
| [235]  | Logic rule 9    |  |
| [236]  | SL time-out 8   |  |
| [237]  | SL time-out 9   |  |

| Option | Name                | Description |
|--------|---------------------|-------------|
| [238]  | RS flipflop 8       |             |
| [239]  | RS flipflop 9       |             |
| [240]  | SL digital output A |             |
| [241]  | SL digital output B |             |
| [242]  | SL digital output C |             |
| [243]  | SL digital output D |             |
| [244]  | SL digital output E |             |
| [245]  | SL digital output F |             |

## Parameter 13-54 SL Controller 2 Action

Table 689: Parameter 13-54 SL Controller 2 Action

| 13-54 SL Controller 2 Action |                                    |                               |
|------------------------------|------------------------------------|-------------------------------|
| Default value: Size related  | Parameter type: Option, Array [20] | Setup: 2 setups               |
| Conversion index: -          | Data type: Uint8                   | Change during operation: True |

Select the action corresponding to the SLC event. Actions are executed when the corresponding event (defined in *parameter 13-53 SL Controller 2 Event*) is evaluated as true.

| Option | Name                | Description  |
|--------|---------------------|--|
| [0]    | DISABLED            |  |
| [1]    | No action           |  |
| [2]    | Select set-up 1     | Changes the active setup ( <i>parameter 0-10 Active Set-up</i> ) to 1. If the setup is changed, it merges with other setup commands coming from either the digital inputs or via a fieldbus. |
| [3]    | Select set-up 2     | Changes the active setup ( <i>parameter 0-10 Active Set-up</i> ) to 2. If the setup is changed, it merges with other setup commands coming from either the digital inputs or via a fieldbus. |
| [4]    | Select set-up 3     | Changes the active setup ( <i>parameter 0-10 Active Set-up</i> ) to 3. If the setup is changed, it merges with other setup commands coming from either the digital inputs or via a fieldbus. |
| [5]    | Select set-up 4     | Changes the active setup ( <i>parameter 0-10 Active Set-up</i> ) to 4. If the setup is changed, it merges with other setup commands coming from either the digital inputs or via a fieldbus. |
| [10]   | Select preset ref 0 | Selects preset reference 0. If the active preset reference is changed, it merges with other preset reference commands coming from either the digital inputs or via a fieldbus.               |
| [11]   | Select preset ref 1 | Selects preset reference 1. If the active preset reference is changed, it merges with other preset reference commands coming from either the digital inputs or via a fieldbus.               |
| [12]   | Select preset ref 2 | Selects preset reference 2. If the active preset reference is changed, it merges with other preset reference commands coming from either the digital inputs or via a fieldbus.               |
| [13]   | Select preset ref 3 | Selects preset reference 3. If the active preset reference is changed, it merges with other preset reference commands coming from either the digital inputs or via a fieldbus.               |
| [14]   | Select preset ref 4 | Selects preset reference 4. If the active preset reference is changed, it merges with other preset reference commands coming from either the digital inputs or via a fieldbus.               |

| Option | Name                   | Description  |
|--------|------------------------|--|
| [15]   | Select preset ref 5    | Selects preset reference 5. If the active preset reference is changed, it merges with other preset reference commands coming from either the digital inputs or via a fieldbus. |
| [16]   | Select preset ref 6    | Selects preset reference 6. If the active preset reference is changed, it merges with other preset reference commands coming from either the digital inputs or via a fieldbus. |
| [17]   | Select preset ref 7    | Selects preset reference 7. If the active preset reference is changed, it merges with other preset reference commands coming from either the digital inputs or via a fieldbus. |
| [18]   | Select ramp 1          | Selects ramp 1.  |
| [19]   | Select ramp 2          | Selects ramp 2.  |
| [20]   | Select ramp 3          | Selects ramp 3.  |
| [21]   | Select ramp 4          | Selects ramp 4.  |
| [22]   | Run                    | Issues a start command to the drive.   |
| [23]   | Run reverse            | Issues a start reverse command to the drive.   |
| [24]   | Stop                   | Issues a stop command to the drive.  |
| [25]   | Qstop                  | Issues a quick stop command to the drive.  |
| [26]   | Dcstop                 | Issues a DC stop command to the drive.   |
| [27]   | Coast                  | The drive coasts immediately. All stop commands including the coast command stop the SLC.  |
| [28]   | Freeze output          | Freezes the output frequency of the drive.   |
| [29]   | Start timer 0          | Starts timer 0, see <i>parameter 13-20 SL Controller Timer</i> for further description.  |
| [30]   | Start timer 1          | Starts timer 1, see <i>parameter 13-20 SL Controller Timer</i> for further description.  |
| [31]   | Start timer 2          | Starts timer 2, see <i>parameter 13-20 SL Controller Timer</i> for further description.  |
| [32]   | Set digital out A low  | Any output with smart logic output A is low.   |
| [33]   | Set digital out B low  | Any output with smart logic output B is low.   |
| [34]   | Set digital out C low  | Any output with smart logic output C is low.   |
| [35]   | Set digital out D low  | Any output with smart logic output D is low.   |
| [36]   | Set digital out E low  | Any output with smart logic output E is low.   |
| [37]   | Set digital out F low  | Any output with smart logic output F is low.   |
| [38]   | Set digital out A high | Any output with smart logic output A is high.  |
| [39]   | Set digital out B high | Any output with smart logic output B is high.  |
| [40]   | Set digital out C high | Any output with smart logic output C is high.  |
| [41]   | Set digital out D high | Any output with smart logic output D is high.  |
| [42]   | Set digital out E high | Any output with smart logic output E is high.  |
| [43]   | Set digital out F high | Any output with smart logic output F is high.  |
| [60]   | Reset Counter A        | Resets counter A to 0.   |
| [61]   | Reset Counter B        | Resets counter B to 0.   |

| Option | Name              | Description  |
|--------|-------------------|--|
| [62]   | Counter A (up)    |  |
| [63]   | Counter A (down)  |  |
| [64]   | Counter B (up)    |  |
| [65]   | Counter B (down)  |  |
| [70]   | Start timer 3     | Starts timer 3, see <i>parameter 13-20 SL Controller Timer</i> for further description.  |
| [71]   | Start timer 4     | Starts timer 4, see <i>parameter 13-20 SL Controller Timer</i> for further description.  |
| [72]   | Start timer 5     | Starts timer 5, see <i>parameter 13-20 SL Controller Timer</i> for further description.  |
| [73]   | Start timer 6     | Starts timer 6, see <i>parameter 13-20 SL Controller Timer</i> for further description.  |
| [74]   | Start timer 7     | Starts timer 7, see <i>parameter 13-20 SL Controller Timer</i> for further description.  |
| [120]  | Start homing      | <p style="text-align: center;"><b>NOTICE</b></p> <p>This option is available only with software version 48.20 and newer.</p> <p>Activates the homing mode and starts the homing function selected in <i>parameter 17-80 Homing Function</i>. Must remain active until the homing is completed otherwise the homing is aborted.</p> |
| [121]  | Stop homing       | <p style="text-align: center;"><b>NOTICE</b></p> <p>This option is available only with software version 48.20 and newer.</p> <p>Deactivates the homing mode, an active homing function is aborted if the homing is not completed.</p>  |
| [122]  | Enable reference  | <p style="text-align: center;"><b>NOTICE</b></p> <p>This option is available only with software version 48.20 and newer.</p> <p>Sets the enable reference mode.</p>  |
| [123]  | Disable reference | <p style="text-align: center;"><b>NOTICE</b></p> <p>This option is available only with software version 48.20 and newer.</p> <p>Disables the enable reference mode.</p>  |
| [124]  | Relative position | <p style="text-align: center;"><b>NOTICE</b></p> <p>This option is available only with software version 48.20 and newer.</p> <p>Selects the relative position mode instead of the absolute position mode.</p>  |
| [125]  | Absolute position | <p style="text-align: center;"><b>NOTICE</b></p> <p>This option is available only with software version 48.20 and newer.</p>   |

| Option | Name              | Description  |
|--------|-------------------|--|
|        |                   | Selects the absolute position mode instead of the relative position mode.  |
| [126]  | Activate touch    | <p style="text-align: center;"><b>NOTICE</b></p> <p>This option is available only with software version 48.20 and newer.</p> <p>Activates the touch probe positioning mode.</p>  |
| [127]  | Deactivate touch  | <p style="text-align: center;"><b>NOTICE</b></p> <p>This option is available only with software version 48.20 and newer.</p> <p>Deactivates the touch probe positioning mode.</p>  |
| [128]  | Target inverse    | <p style="text-align: center;"><b>NOTICE</b></p> <p>This option is available only with software version 48.20 and newer.</p> <p>Changes the sign of the active target position value.</p>  |
| [129]  | Target            | <p style="text-align: center;"><b>NOTICE</b></p> <p>This option is available only with software version 48.20 and newer.</p> <p>The active target position is not changed.</p>   |
| [130]  | Act. speed mode   | <p style="text-align: center;"><b>NOTICE</b></p> <p>This option is available only with software version 48.20 and newer.</p> <p>Activates the speed mode when option [9] <i>Positioning</i> or option [10] <i>Synchronization</i> is selected in <i>parameter 1-00 Configuration Mode</i>.</p> |
| [131]  | Deact. speed mode | <p style="text-align: center;"><b>NOTICE</b></p> <p>This option is available only with software version 48.20 and newer.</p> <p>Deactivates the speed mode and activates the option selected in <i>parameter 1-00 Configuration Mode</i>.</p>  |

Parameter 13-55 SL Controller 3 Event

Table 690: Parameter 13-55 SL Controller 3 Event

| 13-55 SL Controller 3 Event |                                    |                               |
|-----------------------------|------------------------------------|-------------------------------|
| Default value: Size related | Parameter type: Option, Array [20] | Setup: 2 setups               |
| Conversion index: -         | Data type: Uint8                   | Change during operation: True |

| Option | Name                 | Description   |
|--------|----------------------|---|
| [0]    | False                | Select the boolean input (true or false) to define the smart logic controller event. See <i>parameter 13-01 Start Event</i> (options [0] False–[61] Logic rule 5) and <i>parameter 13-02 Stop Event</i> (options [70] SL Time-out 3–[74] SL Time-out 7) for more information. |
| [1]    | True                 |   |
| [2]    | Running              |   |
| [3]    | In range             |   |
| [4]    | On reference         |   |
| [5]    | Torque limit         |   |
| [6]    | Current limit        |   |
| [7]    | Out of current range |   |
| [8]    | Below I low          |   |
| [9]    | Above I high         |   |
| [10]   | Out of speed range   |   |
| [11]   | Below speed low      |   |
| [12]   | Above speed high     |   |
| [13]   | Out of feedb. range  |   |
| [14]   | Below feedb. low     |   |
| [15]   | Above feedb. high    |   |
| [16]   | Thermal warning      |   |
| [17]   | Mains out of range   |   |
| [18]   | Reversing            |   |
| [19]   | Warning              |   |
| [20]   | Alarm (trip)         |   |
| [21]   | Alarm (trip lock)    |   |
| [22]   | Comparator 0         |   |
| [23]   | Comparator 1         |   |
| [24]   | Comparator 2         |   |
| [25]   | Comparator 3         |   |
| [26]   | Logic rule 0         |   |
| [27]   | Logic rule 1         |   |
| [28]   | Logic rule 2         |   |
| [29]   | Logic rule 3         |   |
| [30]   | SL time-out 0        |   |

| Option | Name                | Description  |
|--------|---------------------|--|
| [31]   | SL time-out 1       |  |
| [32]   | SL time-out 2       |  |
| [33]   | Digital input DI18  |  |
| [34]   | Digital input DI19  |  |
| [35]   | Digital input DI27  |  |
| [36]   | Digital input DI29  |  |
| [37]   | Digital input DI32  |  |
| [38]   | Digital input DI33  |  |
| [39]   | Start command       |  |
| [40]   | Drive stopped       |  |
| [41]   | Reset trip          |  |
| [42]   | Auto-reset trip     |  |
| [43]   | OK key              | [OK] is pressed. Only available on the graphical LCP.    |
| [44]   | Reset key           | [Reset] is pressed. Only available on the graphical LCP. |
| [45]   | Left key            | [◀] is pressed. Only available on the graphical LCP.     |
| [46]   | Right key           | [▶] is pressed. Only available on the graphical LCP.     |
| [47]   | Up key              | [▲] is pressed. Only available on the graphical LCP.     |
| [48]   | Down key            | [▼] is pressed. Only available on the graphical LCP.     |
| [50]   | Comparator 4        | Use the result of comparator 4.                          |
| [51]   | Comparator 5        | Use the result of comparator 5.                          |
| [60]   | Logic rule 4        | Use the result of logic rule 4.                          |
| [61]   | Logic rule 5        | Use the result of logic rule 5.                          |
| [70]   | SL time-out 3       |  |
| [71]   | SL time-out 4       |  |
| [72]   | SL time-out 5       |  |
| [73]   | SL time-out 6       |  |
| [74]   | SL time-out 7       |  |
| [75]   | Start command given |  |
| [76]   | Digital input X30/2 |  |
| [77]   | Digital input X30/3 |  |
| [78]   | Digital input X30/4 |  |
| [79]   | Digital input X46/1 |  |

| Option | Name                   | Description  |
|--------|------------------------|--|
| [80]   | Digital input X46/3    |  |
| [81]   | Digital input X46/5    |  |
| [82]   | Digital input X46/7    |  |
| [83]   | Digital input X46/9    |  |
| [84]   | Digital input X46/11   |  |
| [85]   | Digital input X46/13   |  |
| [90]   | ATEX ETR cur. warning  | Available if <i>parameter 1-90 Motor Thermal Protection</i> is set to [20] ATEX ETR or [21] Advanced ETR. If <i>alarm 164, ATEX ETR cur.lim.alarm</i> is active, the output is 1.      |
| [91]   | ATEX ETR cur. alarm    | Available if <i>parameter 1-90 Motor Thermal Protection</i> is set to [20] ATEX ETR or [21] Advanced ETR. If <i>alarm 166, ATEX ETR freq.lim.alarm</i> is active, the output is 1.     |
| [92]   | ATEX ETR freq. warning | Available if <i>parameter 1-90 Motor Thermal Protection</i> is set to [20] ATEX ETR or [21] Advanced ETR. If <i>alarm 163, ATEX ETR cur.lim.warning</i> is active, the output is 1.    |
| [93]   | ATEX ETR freq. alarm   | Available if <i>parameter 1-90 Motor Thermal Protection</i> is set to [20] ATEX ETR or [21] Advanced ETR. If <i>warning 165, ATEX ETR freq.lim.warning</i> is active, the output is 1. |
| [94]   | RS Flipflop 0          | See <i>parameter group 13-1* Comparators</i> .   |
| [95]   | RS Flipflop 1          | See <i>parameter group 13-1* Comparators</i> .   |
| [96]   | RS Flipflop 2          | See <i>parameter group 13-1* Comparators</i> .   |
| [97]   | RS Flipflop 3          | See <i>parameter group 13-1* Comparators</i> .   |
| [98]   | RS Flipflop 4          | See <i>parameter group 13-1* Comparators</i> .   |
| [99]   | RS Flipflop 5          | See <i>parameter group 13-1* Comparators</i> .   |
| [100]  | RS Flipflop 6          | See <i>parameter group 13-1* Comparators</i> .   |
| [101]  | RS Flipflop 7          | See <i>parameter group 13-1* Comparators</i> .   |
| [102]  | Relay 1                |  |
| [103]  | Relay 2                |  |
| [104]  | Relay 3                | X47/VLT® Extended Relay Card MCB 113.  |
| [105]  | Relay 4                | X47/VLT® Extended Relay Card MCB 113.  |
| [106]  | Relay 5                | X47/VLT® Extended Relay Card MCB 113.  |
| [107]  | Relay 6                | X47/VLT® Extended Relay Card MCB 113.  |
| [108]  | Relay 7                | X34/VLT® Relay Card MCB 105.   |
| [109]  | Relay 8                | X34/VLT® Relay Card MCB 105.   |
| [110]  | Relay 9                | X34/VLT® Relay Card MCB 105.   |
| [212]  | Emergency mode         |  |



| Option | Name            | Description  |
|--------|-----------------|--|
| [222]  | Homing OK       | <p style="text-align: center;"><b>NOTICE</b></p> <p>This option is only available with software version 48.2X or newer.</p> <p>Homing is completed with the selected homing function (<i>parameter 17-80 Homing Function</i>).</p>   |
| [223]  | On target       | <p style="text-align: center;"><b>NOTICE</b></p> <p>This option is only available with software version 48.2X or newer.</p> <p>Positioning is completed and the on target signal is sent when the actual position is within <i>parameter 3-05 On Reference Window</i> for the duration of <i>parameter 3-09 On Target Time</i> and the actual speed does not exceed <i>parameter 3-05 On Reference Window</i>.</p> |
| [224]  | Position error  | <p style="text-align: center;"><b>NOTICE</b></p> <p>This option is only available with software version 48.2X or newer.</p> <p>The position error exceeds the value in <i>parameter 4-71 Maximum Position Error</i> for the time set in <i>parameter 4-72 Position Error Timeout</i>.</p>  |
| [225]  | Position limit  | <p style="text-align: center;"><b>NOTICE</b></p> <p>This option is only available with software version 48.2X or newer.</p> <p>The position is outside the limits set in <i>parameter 3-06 Minimum Position</i> and <i>parameter 3-07 Maximum Position</i>.</p>  |
| [226]  | Touch on target | <p style="text-align: center;"><b>NOTICE</b></p> <p>This option is only available with software version 48.2X or newer.</p> <p>Target position is reached in touch probe position mode.</p>  |
| [227]  | Touch activated | Touch probe positioning is active. The drive monitors the touch probe sensor input.  |
| [228]  | Comparator 6    |  |
| [229]  | Comparator 7    |  |
| [230]  | Comparator 8    |  |
| [231]  | Comparator 9    |  |
| [232]  | Logic rule 6    |  |
| [233]  | Logic rule 7    |  |
| [234]  | Logic rule 8    |  |
| [235]  | Logic rule 9    |  |
| [236]  | SL time-out 8   |  |
| [237]  | SL time-out 9   |  |

| Option | Name                | Description |
|--------|---------------------|-------------|
| [238]  | RS flipflop 8       |             |
| [239]  | RS flipflop 9       |             |
| [240]  | SL digital output A |             |
| [241]  | SL digital output B |             |
| [242]  | SL digital output C |             |
| [243]  | SL digital output D |             |
| [244]  | SL digital output E |             |
| [245]  | SL digital output F |             |

## Parameter 13-56 SL Controller 3 Action

Table 691: Parameter 13-56 SL Controller 3 Action

| 13-56 SL Controller 3 Action |                                    |                               |
|------------------------------|------------------------------------|-------------------------------|
| Default value: Size related  | Parameter type: Option, Array [20] | Setup: 2 setups               |
| Conversion index: -          | Data type: Uint8                   | Change during operation: True |

Select the action corresponding to the SLC event. Actions are executed when the corresponding event (defined in *parameter 13-55 SL Controller 3 Event*) is evaluated as true.

| Option | Name                | Description  |
|--------|---------------------|--|
| [0]    | DISABLED            |  |
| [1]    | No action           |  |
| [2]    | Select set-up 1     | Changes the active setup ( <i>parameter 0-10 Active Set-up</i> ) to 1. If the setup is changed, it merges with other setup commands coming from either the digital inputs or via a fieldbus. |
| [3]    | Select set-up 2     | Changes the active setup ( <i>parameter 0-10 Active Set-up</i> ) to 2. If the setup is changed, it merges with other setup commands coming from either the digital inputs or via a fieldbus. |
| [4]    | Select set-up 3     | Changes the active setup ( <i>parameter 0-10 Active Set-up</i> ) to 3. If the setup is changed, it merges with other setup commands coming from either the digital inputs or via a fieldbus. |
| [5]    | Select set-up 4     | Changes the active setup ( <i>parameter 0-10 Active Set-up</i> ) to 4. If the setup is changed, it merges with other setup commands coming from either the digital inputs or via a fieldbus. |
| [10]   | Select preset ref 0 | Selects preset reference 0. If the active preset reference is changed, it merges with other preset reference commands coming from either the digital inputs or via a fieldbus.               |
| [11]   | Select preset ref 1 | Selects preset reference 1. If the active preset reference is changed, it merges with other preset reference commands coming from either the digital inputs or via a fieldbus.               |
| [12]   | Select preset ref 2 | Selects preset reference 2. If the active preset reference is changed, it merges with other preset reference commands coming from either the digital inputs or via a fieldbus.               |
| [13]   | Select preset ref 3 | Selects preset reference 3. If the active preset reference is changed, it merges with other preset reference commands coming from either the digital inputs or via a fieldbus.               |
| [14]   | Select preset ref 4 | Selects preset reference 4. If the active preset reference is changed, it merges with other preset reference commands coming from either the digital inputs or via a fieldbus.               |

| Option | Name                   | Description  |
|--------|------------------------|--|
| [15]   | Select preset ref 5    | Selects preset reference 5. If the active preset reference is changed, it merges with other preset reference commands coming from either the digital inputs or via a fieldbus. |
| [16]   | Select preset ref 6    | Selects preset reference 6. If the active preset reference is changed, it merges with other preset reference commands coming from either the digital inputs or via a fieldbus. |
| [17]   | Select preset ref 7    | Selects preset reference 7. If the active preset reference is changed, it merges with other preset reference commands coming from either the digital inputs or via a fieldbus. |
| [18]   | Select ramp 1          | Selects ramp 1.  |
| [19]   | Select ramp 2          | Selects ramp 2.  |
| [20]   | Select ramp 3          | Selects ramp 3.  |
| [21]   | Select ramp 4          | Selects ramp 4.  |
| [22]   | Run                    | Issues a start command to the drive.   |
| [23]   | Run reverse            | Issues a start reverse command to the drive.   |
| [24]   | Stop                   | Issues a stop command to the drive.  |
| [25]   | Qstop                  | Issues a quick stop command to the drive.  |
| [26]   | Dcstop                 | Issues a DC stop command to the drive.   |
| [27]   | Coast                  | The drive coasts immediately. All stop commands including the coast command stop the SLC.  |
| [28]   | Freeze output          | Freezes the output frequency of the drive.   |
| [29]   | Start timer 0          | Starts timer 0, see <i>parameter 13-20 SL Controller Timer</i> for further description.  |
| [30]   | Start timer 1          | Starts timer 1, see <i>parameter 13-20 SL Controller Timer</i> for further description.  |
| [31]   | Start timer 2          | Starts timer 2, see <i>parameter 13-20 SL Controller Timer</i> for further description.  |
| [32]   | Set digital out A low  | Any output with smart logic output A is low.   |
| [33]   | Set digital out B low  | Any output with smart logic output B is low.   |
| [34]   | Set digital out C low  | Any output with smart logic output C is low.   |
| [35]   | Set digital out D low  | Any output with smart logic output D is low.   |
| [36]   | Set digital out E low  | Any output with smart logic output E is low.   |
| [37]   | Set digital out F low  | Any output with smart logic output F is low.   |
| [38]   | Set digital out A high | Any output with smart logic output A is high.  |
| [39]   | Set digital out B high | Any output with smart logic output B is high.  |
| [40]   | Set digital out C high | Any output with smart logic output C is high.  |
| [41]   | Set digital out D high | Any output with smart logic output D is high.  |
| [42]   | Set digital out E high | Any output with smart logic output E is high.  |
| [43]   | Set digital out F high | Any output with smart logic output F is high.  |
| [60]   | Reset Counter A        | Resets counter A to 0.   |
| [61]   | Reset Counter B        | Resets counter B to 0.   |

| Option | Name              | Description  |
|--------|-------------------|--|
| [62]   | Counter A (up)    |  |
| [63]   | Counter A (down)  |  |
| [64]   | Counter B (up)    |  |
| [65]   | Counter B (down)  |  |
| [70]   | Start timer 3     | Starts timer 3, see <i>parameter 13-20 SL Controller Timer</i> for further description.  |
| [71]   | Start timer 4     | Starts timer 4, see <i>parameter 13-20 SL Controller Timer</i> for further description.  |
| [72]   | Start timer 5     | Starts timer 5, see <i>parameter 13-20 SL Controller Timer</i> for further description.  |
| [73]   | Start timer 6     | Starts timer 6, see <i>parameter 13-20 SL Controller Timer</i> for further description.  |
| [74]   | Start timer 7     | Starts timer 7, see <i>parameter 13-20 SL Controller Timer</i> for further description.  |
| [120]  | Start homing      | <p style="text-align: center;"><b>NOTICE</b></p> <p>This option is available only with software version 48.20 and newer.</p> <p>Activates the homing mode and starts the homing function selected in <i>parameter 17-80 Homing Function</i>. Must remain active until the homing is completed otherwise the homing is aborted.</p> |
| [121]  | Stop homing       | <p style="text-align: center;"><b>NOTICE</b></p> <p>This option is available only with software version 48.20 and newer.</p> <p>Deactivates the homing mode, an active homing function is aborted if the homing is not completed.</p>  |
| [122]  | Enable reference  | <p style="text-align: center;"><b>NOTICE</b></p> <p>This option is available only with software version 48.20 and newer.</p> <p>Sets the enable reference mode.</p>  |
| [123]  | Disable reference | <p style="text-align: center;"><b>NOTICE</b></p> <p>This option is available only with software version 48.20 and newer.</p> <p>Disables the enable reference mode.</p>  |
| [124]  | Relative position | <p style="text-align: center;"><b>NOTICE</b></p> <p>This option is available only with software version 48.20 and newer.</p> <p>Selects the relative position mode instead of the absolute position mode.</p>  |
| [125]  | Absolute position | <p style="text-align: center;"><b>NOTICE</b></p> <p>This option is available only with software version 48.20 and newer.</p>   |

| Option | Name              | Description  |
|--------|-------------------|--|
|        |                   | Selects the absolute position mode instead of the relative position mode.  |
| [126]  | Activate touch    | <p style="text-align: center;"><b>NOTICE</b></p> <p>This option is available only with software version 48.20 and newer.</p> <p>Activates the touch probe positioning mode.</p>  |
| [127]  | Deactivate touch  | <p style="text-align: center;"><b>NOTICE</b></p> <p>This option is available only with software version 48.20 and newer.</p> <p>Deactivates the touch probe positioning mode.</p>  |
| [128]  | Target inverse    | <p style="text-align: center;"><b>NOTICE</b></p> <p>This option is available only with software version 48.20 and newer.</p> <p>Changes the sign of the active target position value.</p>  |
| [129]  | Target            | <p style="text-align: center;"><b>NOTICE</b></p> <p>This option is available only with software version 48.20 and newer.</p> <p>The active target position is not changed.</p>   |
| [130]  | Act. speed mode   | <p style="text-align: center;"><b>NOTICE</b></p> <p>This option is available only with software version 48.20 and newer.</p> <p>Activates the speed mode when option [9] Positioning or option [10] Synchronization is selected in <i>parameter 1-00 Configuration Mode</i>.</p> |
| [131]  | Deact. speed mode | <p style="text-align: center;"><b>NOTICE</b></p> <p>This option is available only with software version 48.20 and newer.</p> <p>Deactivates the speed mode and activates the option selected in <i>parameter 1-00 Configuration Mode</i>.</p>                                    |

Parameter 13-57 SL Controller 4 Event

Table 692: Parameter 13-57 SL Controller 4 Event

| 13-57 SL Controller 4 Event |                                    |                               |
|-----------------------------|------------------------------------|-------------------------------|
| Default value: Size related | Parameter type: Option, Array [20] | Setup: 2 setups               |
| Conversion index: -         | Data type: Uint8                   | Change during operation: True |

| Option | Name                 | Description   |
|--------|----------------------|---|
| [0]    | False                | Select the boolean input (true or false) to define the smart logic controller event. See <i>parameter 13-01 Start Event</i> (options [0] False–[61] Logic rule 5) and <i>parameter 13-02 Stop Event</i> (options [70] SL Time-out 3–[74] SL Time-out 7) for more information. |
| [1]    | True                 |   |
| [2]    | Running              |   |
| [3]    | In range             |   |
| [4]    | On reference         |   |
| [5]    | Torque limit         |   |
| [6]    | Current limit        |   |
| [7]    | Out of current range |   |
| [8]    | Below I low          |   |
| [9]    | Above I high         |   |
| [10]   | Out of speed range   |   |
| [11]   | Below speed low      |   |
| [12]   | Above speed high     |   |
| [13]   | Out of feedb. range  |   |
| [14]   | Below feedb. low     |   |
| [15]   | Above feedb. high    |   |
| [16]   | Thermal warning      |   |
| [17]   | Mains out of range   |   |
| [18]   | Reversing            |   |
| [19]   | Warning              |   |
| [20]   | Alarm (trip)         |   |
| [21]   | Alarm (trip lock)    |   |
| [22]   | Comparator 0         |   |
| [23]   | Comparator 1         |   |
| [24]   | Comparator 2         |   |
| [25]   | Comparator 3         |   |
| [26]   | Logic rule 0         |   |
| [27]   | Logic rule 1         |   |
| [28]   | Logic rule 2         |   |
| [29]   | Logic rule 3         |   |
| [30]   | SL time-out 0        |   |

| Option | Name                | Description   |
|--------|---------------------|---|
| [31]   | SL time-out 1       |   |
| [32]   | SL time-out 2       |   |
| [33]   | Digital input DI18  |   |
| [34]   | Digital input DI19  |   |
| [35]   | Digital input DI27  |   |
| [36]   | Digital input DI29  | <div style="text-align: center; background-color: #cccccc; padding: 5px;"><b>NOTICE</b></div> <div style="border: 1px solid black; padding: 5px; margin-top: 5px;">This option is only available in FC 302.</div> |
| [37]   | Digital input DI32  |   |
| [38]   | Digital input DI33  |   |
| [39]   | Start command       |   |
| [40]   | Drive stopped       |   |
| [41]   | Reset trip          |   |
| [42]   | Auto-reset trip     |   |
| [43]   | OK key              | [OK] is pressed. Only available on the graphical LCP.   |
| [44]   | Reset key           | [Reset] is pressed. Only available on the graphical LCP.  |
| [45]   | Left key            | [◀] is pressed. Only available on the graphical LCP.  |
| [46]   | Right key           | [▶] is pressed. Only available on the graphical LCP.  |
| [47]   | Up key              | [▲] is pressed. Only available on the graphical LCP.  |
| [48]   | Down key            | [▼] is pressed. Only available on the graphical LCP.  |
| [50]   | Comparator 4        | Use the result of comparator 4.   |
| [51]   | Comparator 5        | Use the result of comparator 5.   |
| [60]   | Logic rule 4        | Use the result of logic rule 4.   |
| [61]   | Logic rule 5        | Use the result of logic rule 5.   |
| [70]   | SL time-out 3       |   |
| [71]   | SL time-out 4       |   |
| [72]   | SL time-out 5       |   |
| [73]   | SL time-out 6       |   |
| [74]   | SL time-out 7       |   |
| [75]   | Start command given |   |
| [76]   | Digital input X30/2 |   |
| [77]   | Digital input X30/3 |   |

| Option | Name                   | Description  |
|--------|------------------------|--|
| [78]   | Digital input X30/4    |  |
| [79]   | Digital input X46/1    |  |
| [80]   | Digital input X46/3    |  |
| [81]   | Digital input X46/5    |  |
| [82]   | Digital input X46/7    |  |
| [83]   | Digital input X46/9    |  |
| [84]   | Digital input X46/11   |  |
| [85]   | Digital input X46/13   |  |
| [90]   | ATEX ETR cur. warning  | Available if <i>parameter 1-90 Motor Thermal Protection</i> is set to [20] ATEX ETR or [21] Advanced ETR. If <i>alarm 164, ATEX ETR cur.lim.alarm</i> is active, the output is 1.      |
| [91]   | ATEX ETR cur. alarm    | Available if <i>parameter 1-90 Motor Thermal Protection</i> is set to [20] ATEX ETR or [21] Advanced ETR. If <i>alarm 166, ATEX ETR freq.lim.alarm</i> is active, the output is 1.     |
| [92]   | ATEX ETR freq. warning | Available if <i>parameter 1-90 Motor Thermal Protection</i> is set to [20] ATEX ETR or [21] Advanced ETR. If <i>alarm 163, ATEX ETR cur.lim.warning</i> is active, the output is 1.    |
| [93]   | ATEX ETR freq. alarm   | Available if <i>parameter 1-90 Motor Thermal Protection</i> is set to [20] ATEX ETR or [21] Advanced ETR. If <i>warning 165, ATEX ETR freq.lim.warning</i> is active, the output is 1. |
| [94]   | RS Flipflop 0          | See <i>parameter group 13-1* Comparators</i> .   |
| [95]   | RS Flipflop 1          | See <i>parameter group 13-1* Comparators</i> .   |
| [96]   | RS Flipflop 2          | See <i>parameter group 13-1* Comparators</i> .   |
| [97]   | RS Flipflop 3          | See <i>parameter group 13-1* Comparators</i> .   |
| [98]   | RS Flipflop 4          | See <i>parameter group 13-1* Comparators</i> .   |
| [99]   | RS Flipflop 5          | See <i>parameter group 13-1* Comparators</i> .   |
| [100]  | RS Flipflop 6          | See <i>parameter group 13-1* Comparators</i> .   |
| [101]  | RS Flipflop 7          | See <i>parameter group 13-1* Comparators</i> .   |
| [102]  | Relay 1                |  |
| [103]  | Relay 2                |  |
| [104]  | Relay 3                | X47/VLT® Extended Relay Card MCB 113.  |
| [105]  | Relay 4                | X47/VLT® Extended Relay Card MCB 113.  |
| [106]  | Relay 5                | X47/VLT® Extended Relay Card MCB 113.  |
| [107]  | Relay 6                | X47/VLT® Extended Relay Card MCB 113.  |
| [108]  | Relay 7                | X34/VLT® Relay Card MCB 105.   |
| [109]  | Relay 8                | X34/VLT® Relay Card MCB 105.   |
| [110]  | Relay 9                | X34/VLT® Relay Card MCB 105.   |
| [212]  | Emergency mode         |  |



| Option | Name            | Description  |
|--------|-----------------|--|
| [222]  | Homing OK       | <p style="text-align: center;"><b>NOTICE</b></p> <p>This option is only available with software version 48.2X or newer.</p> <p>Homing is completed with the selected homing function (<i>parameter 17-80 Homing Function</i>).</p>   |
| [223]  | On target       | <p style="text-align: center;"><b>NOTICE</b></p> <p>This option is only available with software version 48.2X or newer.</p> <p>Positioning is completed and the on target signal is sent when the actual position is within <i>parameter 3-05 On Reference Window</i> for the duration of <i>parameter 3-09 On Target Time</i> and the actual speed does not exceed <i>parameter 3-05 On Reference Window</i>.</p> |
| [224]  | Position error  | <p style="text-align: center;"><b>NOTICE</b></p> <p>This option is only available with software version 48.2X or newer.</p> <p>The position error exceeds the value in <i>parameter 4-71 Maximum Position Error</i> for the time set in <i>parameter 4-72 Position Error Timeout</i>.</p>  |
| [225]  | Position limit  | <p style="text-align: center;"><b>NOTICE</b></p> <p>This option is only available with software version 48.2X or newer.</p> <p>The position is outside the limits set in <i>parameter 3-06 Minimum Position</i> and <i>parameter 3-07 Maximum Position</i>.</p>  |
| [226]  | Touch on target | <p style="text-align: center;"><b>NOTICE</b></p> <p>This option is only available with software version 48.2X or newer.</p> <p>Target position is reached in touch probe position mode.</p>  |
| [227]  | Touch activated | Touch probe positioning is active. The drive monitors the touch probe sensor input.  |
| [228]  | Comparator 6    |  |
| [229]  | Comparator 7    |  |
| [230]  | Comparator 8    |  |
| [231]  | Comparator 9    |  |
| [232]  | Logic rule 6    |  |
| [233]  | Logic rule 7    |  |
| [234]  | Logic rule 8    |  |
| [235]  | Logic rule 9    |  |
| [236]  | SL time-out 8   |  |
| [237]  | SL time-out 9   |  |

| Option | Name                | Description |
|--------|---------------------|-------------|
| [238]  | RS flipflop 8       |             |
| [239]  | RS flipflop 9       |             |
| [240]  | SL digital output A |             |
| [241]  | SL digital output B |             |
| [242]  | SL digital output C |             |
| [243]  | SL digital output D |             |
| [244]  | SL digital output E |             |
| [245]  | SL digital output F |             |

## Parameter 13-58 SL Controller 4 Action

Table 693: Parameter 13-58 SL Controller 4 Action

| 13-58 SL Controller 4 Action |                                    |                               |
|------------------------------|------------------------------------|-------------------------------|
| Default value: Size related  | Parameter type: Option, Array [20] | Setup: 2 setups               |
| Conversion index: -          | Data type: Uint8                   | Change during operation: True |

Select the action corresponding to the SLC event. Actions are executed when the corresponding event (defined in *parameter 13-57 SL Controller 4 Event*) is evaluated as true.

| Option | Name                | Description  |
|--------|---------------------|--|
| [0]    | DISABLED            |  |
| [1]    | No action           |  |
| [2]    | Select set-up 1     | Changes the active setup ( <i>parameter 0-10 Active Set-up</i> ) to 1. If the setup is changed, it merges with other setup commands coming from either the digital inputs or via a fieldbus. |
| [3]    | Select set-up 2     | Changes the active setup ( <i>parameter 0-10 Active Set-up</i> ) to 2. If the setup is changed, it merges with other setup commands coming from either the digital inputs or via a fieldbus. |
| [4]    | Select set-up 3     | Changes the active setup ( <i>parameter 0-10 Active Set-up</i> ) to 3. If the setup is changed, it merges with other setup commands coming from either the digital inputs or via a fieldbus. |
| [5]    | Select set-up 4     | Changes the active setup ( <i>parameter 0-10 Active Set-up</i> ) to 4. If the setup is changed, it merges with other setup commands coming from either the digital inputs or via a fieldbus. |
| [10]   | Select preset ref 0 | Selects preset reference 0. If the active preset reference is changed, it merges with other preset reference commands coming from either the digital inputs or via a fieldbus.               |
| [11]   | Select preset ref 1 | Selects preset reference 1. If the active preset reference is changed, it merges with other preset reference commands coming from either the digital inputs or via a fieldbus.               |
| [12]   | Select preset ref 2 | Selects preset reference 2. If the active preset reference is changed, it merges with other preset reference commands coming from either the digital inputs or via a fieldbus.               |
| [13]   | Select preset ref 3 | Selects preset reference 3. If the active preset reference is changed, it merges with other preset reference commands coming from either the digital inputs or via a fieldbus.               |
| [14]   | Select preset ref 4 | Selects preset reference 4. If the active preset reference is changed, it merges with other preset reference commands coming from either the digital inputs or via a fieldbus.               |

| Option | Name                   | Description  |
|--------|------------------------|--|
| [15]   | Select preset ref 5    | Selects preset reference 5. If the active preset reference is changed, it merges with other preset reference commands coming from either the digital inputs or via a fieldbus. |
| [16]   | Select preset ref 6    | Selects preset reference 6. If the active preset reference is changed, it merges with other preset reference commands coming from either the digital inputs or via a fieldbus. |
| [17]   | Select preset ref 7    | Selects preset reference 7. If the active preset reference is changed, it merges with other preset reference commands coming from either the digital inputs or via a fieldbus. |
| [18]   | Select ramp 1          | Selects ramp 1.  |
| [19]   | Select ramp 2          | Selects ramp 2.  |
| [20]   | Select ramp 3          | Selects ramp 3.  |
| [21]   | Select ramp 4          | Selects ramp 4.  |
| [22]   | Run                    | Issues a start command to the drive.   |
| [23]   | Run reverse            | Issues a start reverse command to the drive.   |
| [24]   | Stop                   | Issues a stop command to the drive.  |
| [25]   | Qstop                  | Issues a quick stop command to the drive.  |
| [26]   | Dcstop                 | Issues a DC stop command to the drive.   |
| [27]   | Coast                  | The drive coasts immediately. All stop commands including the coast command stop the SLC.  |
| [28]   | Freeze output          | Freezes the output frequency of the drive.   |
| [29]   | Start timer 0          | Starts timer 0, see <i>parameter 13-20 SL Controller Timer</i> for further description.  |
| [30]   | Start timer 1          | Starts timer 1, see <i>parameter 13-20 SL Controller Timer</i> for further description.  |
| [31]   | Start timer 2          | Starts timer 2, see <i>parameter 13-20 SL Controller Timer</i> for further description.  |
| [32]   | Set digital out A low  | Any output with smart logic output A is low.   |
| [33]   | Set digital out B low  | Any output with smart logic output B is low.   |
| [34]   | Set digital out C low  | Any output with smart logic output C is low.   |
| [35]   | Set digital out D low  | Any output with smart logic output D is low.   |
| [36]   | Set digital out E low  | Any output with smart logic output E is low.   |
| [37]   | Set digital out F low  | Any output with smart logic output F is low.   |
| [38]   | Set digital out A high | Any output with smart logic output A is high.  |
| [39]   | Set digital out B high | Any output with smart logic output B is high.  |
| [40]   | Set digital out C high | Any output with smart logic output C is high.  |
| [41]   | Set digital out D high | Any output with smart logic output D is high.  |
| [42]   | Set digital out E high | Any output with smart logic output E is high.  |
| [43]   | Set digital out F high | Any output with smart logic output F is high.  |
| [60]   | Reset Counter A        | Resets counter A to 0.   |
| [61]   | Reset Counter B        | Resets counter B to 0.   |

| Option | Name              | Description  |
|--------|-------------------|--|
| [62]   | Counter A (up)    |  |
| [63]   | Counter A (down)  |  |
| [64]   | Counter B (up)    |  |
| [65]   | Counter B (down)  |  |
| [70]   | Start timer 3     | Starts timer 3, see <i>parameter 13-20 SL Controller Timer</i> for further description.  |
| [71]   | Start timer 4     | Starts timer 4, see <i>parameter 13-20 SL Controller Timer</i> for further description.  |
| [72]   | Start timer 5     | Starts timer 5, see <i>parameter 13-20 SL Controller Timer</i> for further description.  |
| [73]   | Start timer 6     | Starts timer 6, see <i>parameter 13-20 SL Controller Timer</i> for further description.  |
| [74]   | Start timer 7     | Starts timer 7, see <i>parameter 13-20 SL Controller Timer</i> for further description.  |
| [120]  | Start homing      | <p style="text-align: center;"><b>NOTICE</b></p> <p>This option is available only with software version 48.20 and newer.</p> <p>Activates the homing mode and starts the homing function selected in <i>parameter 17-80 Homing Function</i>. Must remain active until the homing is completed otherwise the homing is aborted.</p> |
| [121]  | Stop homing       | <p style="text-align: center;"><b>NOTICE</b></p> <p>This option is available only with software version 48.20 and newer.</p> <p>Deactivates the homing mode, an active homing function is aborted if the homing is not completed.</p>  |
| [122]  | Enable reference  | <p style="text-align: center;"><b>NOTICE</b></p> <p>This option is available only with software version 48.20 and newer.</p> <p>Sets the enable reference mode.</p>  |
| [123]  | Disable reference | <p style="text-align: center;"><b>NOTICE</b></p> <p>This option is available only with software version 48.20 and newer.</p> <p>Disables the enable reference mode.</p>  |
| [124]  | Relative position | <p style="text-align: center;"><b>NOTICE</b></p> <p>This option is available only with software version 48.20 and newer.</p> <p>Selects the relative position mode instead of the absolute position mode.</p>  |
| [125]  | Absolute position | <p style="text-align: center;"><b>NOTICE</b></p> <p>This option is available only with software version 48.20 and newer.</p>   |

| Option | Name              | Description  |
|--------|-------------------|--|
|        |                   | Selects the absolute position mode instead of the relative position mode.  |
| [126]  | Activate touch    | <p style="text-align: center;"><b>NOTICE</b></p> <p>This option is available only with software version 48.20 and newer.</p> <p>Activates the touch probe positioning mode.</p>  |
| [127]  | Deactivate touch  | <p style="text-align: center;"><b>NOTICE</b></p> <p>This option is available only with software version 48.20 and newer.</p> <p>Deactivates the touch probe positioning mode.</p>  |
| [128]  | Target inverse    | <p style="text-align: center;"><b>NOTICE</b></p> <p>This option is available only with software version 48.20 and newer.</p> <p>Changes the sign of the active target position value.</p>  |
| [129]  | Target            | <p style="text-align: center;"><b>NOTICE</b></p> <p>This option is available only with software version 48.20 and newer.</p> <p>The active target position is not changed.</p>   |
| [130]  | Act. speed mode   | <p style="text-align: center;"><b>NOTICE</b></p> <p>This option is available only with software version 48.20 and newer.</p> <p>Activates the speed mode when option [9] <i>Positioning</i> or option [10] <i>Synchronization</i> is selected in <i>parameter 1-00 Configuration Mode</i>.</p> |
| [131]  | Deact. speed mode | <p style="text-align: center;"><b>NOTICE</b></p> <p>This option is available only with software version 48.20 and newer.</p> <p>Deactivates the speed mode and activates the option selected in <i>parameter 1-00 Configuration Mode</i>.</p>  |

### 5.13.6 13-9\* User-defined Alerts and Readouts

Parameters in this group allow the configuration of application-specific triggers for triggering the drive to perform a certain action, show the status on the LCP, and represent it accordingly in *parameter 13-97 Alert Alarm Word*, *parameter 13-98 Alert Warning Word*, and *parameter 13-99 Alert Status Word*. In *parameter 13-91 Alert Action*, it is possible to select drive functionalities such as *info only*, *stop*, *running to max*, and *force drive to trip*.

Use the following parameters to configure the drive to show a message and perform an action when a specific event occurs:

- *Parameter 13-90 Alert Trigger* – the event that triggers the user-defined action and message.
- *Parameter 13-91 Alert Action* – the action that the drive performs when the event defined in *parameter 13-90 Alert Trigger* occurs.
- *Parameter 13-92 Alert Text* – the text that the drive shows in the display when the event defined in *parameter 13-90 Alert Trigger* occurs.

For example, consider the following use case: If there is an active signal on digital input 32, the drive shows the message *Valve 5 open* and ramps down to a stop. To achieve this configuration, make the following settings:

- *Parameter 13-90 Alert Trigger = [37] Digital input DI32.*
- *Parameter 13-91 Alert Action = [5] Stop & warning.*
- *Parameter 13-92 Alert Text = Valve 5 open.*

Actions reflected in *parameter 16-03 Status Word* and alert parameters

When an action containing trip is selected and triggered, the drive trips, bit 3 in the basic status word is set, and the corresponding hex value is shown in *parameter 13-97 Alert Alarm Word*.

The alarm for *User Alert* is logged as alarm value = 124 in *parameter 15-30 Fault Log: Error Code*, index [0]–[9].

When an action containing warning info is selected and triggered, bit 7 in the basic status word is set, and the corresponding hex value is shown in *parameter 13-98 Alert Warning Word*.

Other actions selected are not indicated in the basic status word, but the corresponding hex value is shown in *parameter 13-99 Alert Status Word*.

Example of setting up digital inputs as triggers, actions, and readouts

Refer to the following table to understand the 3 examples in this section.

**Table 694: Example of Setting up Triggers, Actions, and Readouts**

| ID     | Name          | Setup 1                 |
|--------|---------------|-------------------------|
| 1390.0 | Alert Trigger | [34] Digital input DI19 |
| 1390.1 | Alert Trigger | [37] Digital input DI32 |
| 1390.2 | Alert Trigger | [0] False               |
| 1390.3 | Alert Trigger | [0] False               |
| 1390.4 | Alert Trigger | [0] False               |
| 1390.5 | Alert Trigger | [0] False               |
| 1390.6 | Alert Trigger | [0] False               |
| 1390.7 | Alert Trigger | [0] False               |
| 1390.8 | Alert Trigger | [38] Digital input DI33 |
| 1390.9 | Alert Trigger | [0] False               |
| 1391.0 | Alert Action  | [0] Info                |
| 1391.1 | Alert Action  | [1] Warning             |
| 1391.2 | Alert Action  | [0] Info                |
| 1391.3 | Alert Action  | [0] Info                |
| 1391.4 | Alert Action  | [0] Info                |
| 1391.5 | Alert Action  | [0] Info                |
| 1391.6 | Alert Action  | [0] Info                |
| 1391.7 | Alert Action  | [0] Info                |
| 1391.8 | Alert Action  | [12] Trip               |
| 1391.9 | Alert Action  | [0] Info                |
| 1392.0 | Alert Text    | Dig In 19               |
| 1392.1 | Alert Text    | Dig In 32               |

| ID     | Name       | Setup 1    |
|--------|------------|------------|
| 1392.2 | Alert Text | User Alert |
| 1392.3 | Alert Text | User Alert |
| 1392.4 | Alert Text | User Alert |
| 1392.5 | Alert Text | User Alert |
| 1392.6 | Alert Text | User Alert |
| 1392.7 | Alert Text | User Alert |
| 1392.8 | Alert Text | Dig In 33  |
| 1392.9 | Alert Text | User Alert |

**Example 1:** In *parameter 13-90 Alert Trigger*, index [0], DI19 is selected as trigger. The digital value is 0000 0001. The corresponding action, Info, is set in *parameter 13-91 Alert Action*, index [0] and is shown as 1 hex in *parameter 13-99 Alert Status Word*.

**Example 2:** In *parameter 13-90 Alert Trigger*, index [1], DI32 is selected as trigger. The digital value is 0000 0010. The corresponding action, Warning, is set in *parameter 13-91 Alert Action*, index [1] and is shown as 2 hex in *parameter 13-98 Alert Warning Word*.

**Example 3:** In *parameter 13-90 Alert Trigger*, index [8], DI33 is selected as trigger. The digital value is 0001 0000 0000. The corresponding action, Trip, is set in *parameter 13-91 Alert Action*, index [8] and is shown as 100 hex in *parameter 13-97 Alert Alarm Word*. When 1 of the 3 digital inputs shown in this example is activated, the text shown in the LCP is the one defined in *parameter 13-92 Alert Text*, index [0], [1], and [8].

## NOTICE

The action setting of an active trigger cannot be changed. For example, if DI19 is selected as trigger and the input is high, the action cannot be changed from *Stop* to *Jog*.

### Parameter 13-90 Alert Trigger

Table 695: Parameter 13-90 Alert Trigger

| 13-90 Alert Trigger      |                                    |                               |
|--------------------------|------------------------------------|-------------------------------|
| Default value: [0] False | Parameter type: Option, Array [10] | Setup: 2 setups               |
| Conversion index: -      | Data type: Uint8                   | Change during operation: True |

Select the event that triggers the user-defined action and message.

| Option | Name         | Description |
|--------|--------------|-------------|
| [0]*   | False        |             |
| [1]    | True         |             |
| [18]   | Reversing    |             |
| [22]   | Comparator 0 |             |
| [23]   | Comparator 1 |             |
| [24]   | Comparator 2 |             |
| [25]   | Comparator 3 |             |
| [26]   | Logic rule 0 |             |
| [27]   | Logic rule 1 |             |

| Option | Name               | Description   |
|--------|--------------------|---|
| [28]   | Logic rule 2       |   |
| [29]   | Logic rule 3       |   |
| [30]   | SL time-out 0      |   |
| [31]   | SL time-out 1      |   |
| [32]   | SL time-out 2      |   |
| [33]   | Digital input DI18 |   |
| [34]   | Digital input DI19 |   |
| [35]   | Digital input DI27 |   |
| [36]   | Digital input DI29 | <div style="text-align: center; background-color: #cccccc; padding: 5px;"><b>NOTICE</b></div> <p>This option is only available in FC 302.</p> |
| [37]   | Digital input DI32 |   |
| [38]   | Digital input DI33 |   |
| [50]   | Comparator 4       |   |
| [51]   | Comparator 5       |   |
| [60]   | Logic rule 4       |   |
| [61]   | Logic rule 5       |   |
| [70]   | SL time-out 3      |   |
| [71]   | SL time-out 4      |   |
| [72]   | SL time-out 5      |   |
| [73]   | SL time-out 6      |   |
| [74]   | SL time-out 7      |   |
| [94]   | RS flipflop 0      |   |
| [95]   | RS flipflop 1      |   |
| [96]   | RS flipflop 2      |   |
| [97]   | RS flipflop 3      |   |
| [98]   | RS flipflop 4      |   |
| [99]   | RS flipflop 5      |   |
| [100]  | RS flipflop 6      |   |
| [101]  | RS flipflop 7      |   |
| [228]  | Comparator 6       |   |
| [229]  | Comparator 7       |   |



| Option | Name          | Description |
|--------|---------------|-------------|
| [230]  | Comparator 8  |             |
| [231]  | Comparator 9  |             |
| [232]  | Logic rule 6  |             |
| [233]  | Logic rule 7  |             |
| [234]  | Logic rule 8  |             |
| [235]  | Logic rule 9  |             |
| [236]  | SL time-out 8 |             |
| [237]  | SL time-out 9 |             |
| [238]  | RS flipflop 8 |             |
| [239]  | RS flipflop 9 |             |

## Parameter 13-91 Alert Action

Table 696: Parameter 13-91 Alert Action

| 13-91 Alert Action      |                                    |                               |
|-------------------------|------------------------------------|-------------------------------|
| Default value: [0] Info | Parameter type: Option, Array [10] | Setup: 2 setups               |
| Conversion index: -     | Data type: Uint8                   | Change during operation: True |

## N O T I C E

For safety reasons, this parameter cannot be changed when there is an active alarm.

Select the action that the drive performs when the event defined in *parameter 13-90 Alert Trigger* occurs.

| Option | Name                    | Description |
|--------|-------------------------|-------------|
| [0]*   | Info                    |             |
| [1]    | Warning                 |             |
| [2]    | Freeze output           |             |
| [3]    | Freeze output & warn    |             |
| [4]    | Stop                    |             |
| [5]    | Stop & warning          |             |
| [6]    | Jogging                 |             |
| [7]    | Jogging & warning       |             |
| [8]    | Max speed               |             |
| [9]    | Max speed & warn        |             |
| [10]   | Stop and trip           |             |
| [11]   | Stop and w manual reset |             |

| Option | Name                | Description |
|--------|---------------------|-------------|
| [12]   | Trip                |             |
| [13]   | Trip w manual reset |             |
| [14]   | Trip lock           |             |

## Parameter 13-92 Alert Text

Table 697: Parameter 13-92 Alert Text

| 13-92 Alert Text            |   |                               |
|-----------------------------|---|-------------------------------|
| Default value: Size related | Parameter type: Range, 0 - 20, Array [10] | Setup: 2 setups               |
| Conversion index: 0         | Data type: VisStr 20                      | Change during operation: True |

Enter the text that the drive shows in the display when the event is defined in *parameter 13-90 Alert Trigger* occurs.

## Parameter 13-97 Alert Alarm Word

Table 698: Parameter 13-97 Alert Alarm Word

| 13-97 Alert Alarm Word |                                    |                                |
|------------------------|------------------------------------|--------------------------------|
| Default value: 0       | Parameter type: Range, 0 - 3FF hex | Setup: All setups              |
| Conversion index: 0    | Data type: Uint32                  | Change during operation: False |

Shows the alarm word of a user-defined alarm in hex code.

## Parameter 13-98 Alert Warning Word

Table 699: Parameter 13-98 Alert Warning Word

| 13-98 Alert Warning Word |                                    |                                |
|--------------------------|------------------------------------|--------------------------------|
| Default value: 0         | Parameter type: Range, 0 - 3FF hex | Setup: All setups              |
| Conversion index: 0      | Data type: Uint32                  | Change during operation: False |

Shows the warning word of a user-defined alarm in hex code.

## Parameter 13-99 Alert Status Word

Table 700: Parameter 13-99 Alert Status Word

| 13-99 Alert Status Word |                                    |                                |
|-------------------------|------------------------------------|--------------------------------|
| Default value: 0        | Parameter type: Range, 0 - 3FF hex | Setup: All setups              |
| Conversion index: 0     | Data type: Uint32                  | Change during operation: False |

Shows the status word of a user-defined alarm in hex code.

## 5.14 Parameter Group 14-\*\* Special Functions

## 5.14.1 14-0\* Inverter Switching

## Parameter 14-00 Switching Pattern

Table 701: Parameter 14-00 Switching Pattern

| 14-00 Switching Pattern  |                        |                               |
|--------------------------|------------------------|-------------------------------|
| Default value: [1] SFAVM | Parameter type: Option | Setup: All setups             |
| Conversion index: -      | Data type: Uint8       | Change during operation: True |

Select the switching pattern: 60° AVM or SFAVM.

## N O T I C E

The drive may adjust the switching pattern automatically to avoid a trip.

| Option | Name   | Description |
|--------|--------|-------------|
| [0]    | 60 AVM |             |
| [1]*   | SFAVM  |             |

### Parameter 14-01 Switching Frequency

Table 702: Parameter 14-01 Switching Frequency

| 14-01 Switching Frequency   |                        |                               |
|-----------------------------|------------------------|-------------------------------|
| Default value: Size related | Parameter type: Option | Setup: All setups             |
| Conversion index: -         | Data type: Uint8       | Change during operation: True |

Select the drive switching frequency. Changing the switching frequency reduces acoustic noise from the motor. Default values depend on power size.

## N O T I C E

The output frequency value of the drive must never exceed 10% of the switching frequency. When the motor is running, adjust the switching frequency in *parameter 14-01 Switching Frequency* to minimize motor noise.

## N O T I C E

To avoid a trip, the drive can adjust the switching frequency automatically.

| Option | Name     | Description   |
|--------|----------|---|
| [0]    | 1.0 kHz  |   |
| [1]    | 1.5 kHz  | Default switching frequency for 355–1200 kW [500–1600 hp], 690 V.                                   |
| [2]    | 2.0 kHz  | Default switching frequency for 250–800 kW [350–1075 hp], 400 V, and 37–315 kW [50–450 hp], 690 V.  |
| [3]    | 2.5 kHz  |   |
| [4]    | 3.0 kHz  | Default switching frequency for 18.5–37 kW [25–50 hp], 200 V, and 37–200 kW [50–300 hp], 400 V.     |
| [5]    | 3.5 kHz  |   |
| [6]    | 4.0 kHz  | Default switching frequency for 5.5–15 kW [7.5–20 hp], 200 V, and 11–30 kW [15–40], 400 V.          |
| [7]    | 5.0 kHz  | Default switching frequency for 0.25–3.7 kW [0.34–5 hp], 200 V, and 0.37–7.5 kW [0.5–10 hp], 400 V. |
| [8]    | 6.0 kHz  |   |
| [9]    | 7.0 kHz  |   |
| [10]   | 8.0 kHz  |   |
| [11]   | 10.0 kHz |   |

| Option | Name     | Description |
|--------|----------|-------------|
| [12]   | 12.0 kHz |             |
| [13]   | 14.0 kHz |             |
| [14]   | 16.0 kHz |             |

Parameter 14-02 Switching Pattern Shift Frequency

Table 703: Parameter 14-02 Switching Pattern Shift Frequency

| 14-02 Switching Pattern Shift Frequency |                                    |                               |
|---|------------------------------------|-------------------------------|
| Default value: 15 Hz                    | Parameter type: Range, 15 - 590 Hz | Setup: All setups             |
| Conversion index: 0                     | Data type: Uint16                  | Change during operation: True |

Set the frequency where the switching pattern shifts between SFAVM and 60 AVM. Set a value to keep high-speed motors in SFAVM mode during ramp-up and during low-speed operation. The value to set is motor-dependent. The pattern shift frequency can be set when *parameter 14-00 Switching Pattern* is set to [0] 60 AVM.

Parameter 14-03 Overmodulation

Table 704: Parameter 14-03 Overmodulation

| 14-03 Overmodulation        |                        |                                |
|-----------------------------|------------------------|--------------------------------|
| Default value: Size related | Parameter type: Option | Setup: All setups              |
| Conversion index: -         | Data type: Uint8       | Change during operation: False |

**NOTICE**

Overmodulation leads to increased torque ripple as harmonics increase.

| Op-tion | Name         | Description  |
|---------|--------------|--|
| [0]     | Off          | Select [0] Off for no overmodulation of the output voltage to avoid torque ripple on the motor shaft. This feature may be useful for applications such as grinding machines.   |
| [1]     | On           | Select [1] On to enable the overmodulation function for the output voltage. This is the right option when it is required that the output voltage is higher than 95% of the input voltage (typically when running over-synchronously). The output voltage is increased according to the degree of overmodulation. Control in flux control principle provides an output current of up to 98% of the input current, regardless of <i>parameter 14-03 Overmodulation</i> .                                     |
| [2]     | User defined | Modulation index refers to the relation between motor voltage and DC-link voltage. High overmodulation increases the motor voltage and optimizes the motor torque and efficiency by reducing the motor current. A high modulation index increases the risk of torque ripple on the motor shaft. In applications where the torque ripple occur, it can be beneficial to disable the overmodulation. It is possible to configure the setup in the range defined in <i>parameter 40-55 Modulation Index</i> . |

Parameter 14-04 Acoustic Noise Reduction

Table 705: Parameter 14-04 Acoustic Noise Reduction

| 14-04 Acoustic Noise Reduction |                        |                               |
|--------------------------------|------------------------|-------------------------------|
| Default value: [0] Off         | Parameter type: Option | Setup: All setups             |
| Conversion index: -            | Data type: Uint8       | Change during operation: True |

| Option | Name | Description   |
|--------|------|---|
| [0]*   | Off  | No change of the acoustic motor switching noise.    |
| [1]    | On   | Select to reduce the acoustic noise from the motor. |

## Parameter 14-05 PWM Generation

Table 706: Parameter 14-05 PWM Generation

| 14-05 PWM Generation        |                        |                               |
|-----------------------------|------------------------|-------------------------------|
| Default value: [0] Standard | Parameter type: Option | Setup: All setups             |
| Conversion index: -         | Data type: Uint8       | Change during operation: True |

Use this parameter in VVC+ and U/f mode only. When running with low ratio between switch frequency and output frequency (especially close to or <10:1), it is possible to improve the resolution of the PWM modulation and optimize the output voltage.

| Option | Name          | Description   |
|--------|---------------|---|
| [0]*   | Standard      | Use this setting for standard motors.   |
| [1]    | Double update | Updates the PWM pattern twice per switch period. Select this option to achieve a more optimal sinus-wave and slight increase of the output voltage. |

## Parameter 14-06 Dead Time Compensation

Table 707: Parameter 14-06 Dead Time Compensation

| 14-06 Dead Time Compensation |                        |                               |
|------------------------------|------------------------|-------------------------------|
| Default value: [1] On        | Parameter type: Option | Setup: All setups             |
| Conversion index: -          | Data type: Uint8       | Change during operation: True |

| Option | Name | Description                       |
|--------|------|-----------------------------------|
| [0]    | Off  | No compensation.                  |
| [1]*   | On   | Activates dead-time compensation. |

## 5.14.2 14-1\* Mains On/Off

## NOTICE

The following parameter is only available in FC 302:

- *Parameter 14-16 Kin. Back-up Gain*

Parameters for configuring mains failure monitoring and handling. If a mains failure appears, the drive tries to continue in a controlled way until the power in the DC link is exhausted.

## Parameter 14-10 Mains Failure

Table 708: Parameter 14-10 Mains Failure

| 14-10 Mains Failure            |                        |                               |
|--------------------------------|------------------------|-------------------------------|
| Default value: [0] No function | Parameter type: Option | Setup: All setups             |
| Conversion index: -            | Data type: Uint8       | Change during operation: True |

When *parameter 1-00 Configuration Mode* is set to [2] Torque, the following options are inactive:

- [1] Ctrl. ramp-down
- [2] Ctrl. ramp-down, trip
- [5] Kinetic back-up, trip
- [7] Kin. back-up, trip w recovery

## NOTICE

This parameter cannot be changed while the motor is running.

*Parameter 14-10 Mains Failure* is typically used where short mains interruptions (voltage dips) are present. At 100% load and a short voltage interruption, the DC voltage on the main capacitors drops quickly. For larger drives, it only takes a few milliseconds before the DC level drops to about 373 V DC, and the IGBTs cut off and lose the control of the motor. When mains is restored, and the IGBTs start again, the output frequency and voltage vector do not correspond to the speed/frequency of the motor, and the result is normally an overvoltage or overcurrent, mostly resulting in a trip lock. *Parameter 14-10 Mains Failure* can be programmed to avoid this situation. Select the function according to which the drive must act when the threshold in *parameter 14-11 Mains Fault Voltage Level* is reached.

| Op-tion | Name                  | Description  |
|---------|-----------------------|--|
| [0]*    | No function           | The drive does not compensate for a mains interruption. The voltage on the DC link drops quickly and motor control is lost within milliseconds to seconds. This situation results in a trip lock.  |
| [1]     | Ctrl. ramp-down       | Control of the motor remains with the drive, and the drive performs a controlled ramp down from <i>parameter 14-11 Mains Fault Voltage Level</i> . If <i>parameter 2-10 Brake Function</i> is [0] Off or [2] AC brake, the ramp follows the overvoltage ramping. If <i>parameter 2-10 Brake Function</i> is [1] Resistor Brake, the ramp follows the setting in <i>parameter 3-81 Quick Stop Ramp Time</i> . This selection is useful in pump applications, where the inertia is low and the friction is high. When mains is restored, the output frequency ramps the motor up to the reference speed. If the mains interruption is prolonged, the controlled ramp down may bring the output frequency down to 0 RPM, and when the mains is restored, the application is ramped up from 0 RPM to the previous reference speed via the normal ramp-up. If the energy in the DC link disappears before the motor is ramped to 0, the motor is coasted. <b>Limitation:</b> See the introduction text in this parameter. |
| [2]     | Ctrl. ramp-down, trip | The functionality is the same as in [1] Ctrl. ramp-down, except in this option a reset is necessary for starting up after power-up.  |
| [3]     | Coasting              | Centrifuges can run for 1 hour without supply. In those situations, it is possible to select a coast function at mains interruption, together with a flying start, which occurs when the mains is restored.  |
| [4]     | Kinetic back-up       | <p>Kinetic back-up ensures that the drive keeps running as long as there is energy in the system due to the inertia from motor and load. This is done by converting the mechanical energy to the DC link and maintaining control of the drive and motor. This can extend the controlled operation, depending on the inertia in the system. For fans, it is typically several seconds; for pumps up to 2 s; and for compressors only for a fraction of a second. Many industry applications can extend controlled operation for many seconds, which is often enough time for the mains to return.</p> <p style="text-align: right; font-size: small;">e30bc918.10</p>   |

**Illustration 83: Kinetic Back-up**

| Option  | Name   | Description  |   |  |
|---|--|--|---|--|
|   |  | <table border="1" style="width: 100%; border-collapse: collapse;"> <tr> <td style="width: 50%; padding: 5px;"> <p>A Normal operation</p> <p>B Mains failure</p> <p>C Kinetic back-up</p> </td> <td style="width: 50%; padding: 5px;"> <p>D Mains return</p> <p>E Normal operation: Ramping</p> </td> </tr> </table> <p>The DC level during [4] Kinetic backup equals <i>parameter 14-11 Mains Fault Voltage Level</i> x 1.35. If the mains does not return, <math>U_{DC}</math> is maintained as long as possible by ramping the speed down towards 0 RPM. Finally, the drive coasts. If the mains returns while in kinetic back-up mode, <math>U_{DC}</math> increases above <i>parameter 14-11 Mains Fault Voltage Level</i> x 1.35. This is detected in 1 of the following ways:</p> <ul style="list-style-type: none"> <li>• If <math>U_{DC} &gt; \text{parameter 14-11 Mains Fault Voltage Level} \times 1.35 \times 1.05</math>.</li> <li>• If the speed is above the reference. This is relevant if the mains comes back at a lower level than before, for example <i>parameter 14-11 Mains Fault Voltage Level</i> x 1.35 x 1.02. This does not fulfill the criterion in point 1, and the drive tries to reduce <math>U_{DC}</math> to <i>parameter 14-11 Mains Fault Voltage Level</i> x 1.35 by increasing the speed. This cannot be done as the mains cannot be lowered.</li> <li>• If running mechanically. The same mechanism as in point 2 applies, but the inertia prevents the speed from going above the reference speed. This leads to the motor running mechanically until the speed is above the reference speed and the situation in point 2 occurs. Instead of waiting for that criterion, point 3 is introduced.</li> </ul> | <p>A Normal operation</p> <p>B Mains failure</p> <p>C Kinetic back-up</p> | <p>D Mains return</p> <p>E Normal operation: Ramping</p> |
| <p>A Normal operation</p> <p>B Mains failure</p> <p>C Kinetic back-up</p> | <p>D Mains return</p> <p>E Normal operation: Ramping</p> |  |   |  |
| [5]   | Kinetic back-up, trip                                    | <p>The difference between kinetic back-up with and without trip is that the latter always ramps down to 0 RPM and trips, regardless of whether mains returns or not. The function does not detect if mains returns. This is the reason for the relatively high level on the DC link during ramp-down.</p> <p><b>Illustration 84: Kinetic Back-up Trip</b></p> <table border="1" style="width: 100%; border-collapse: collapse;"> <tr> <td style="width: 50%; padding: 5px;"> <p>A Normal operation</p> <p>B Mains failure</p> </td> <td style="width: 50%; padding: 5px;"> <p>C Kinetic back-up</p> <p>D Trip</p> </td> </tr> </table>   | <p>A Normal operation</p> <p>B Mains failure</p>                          | <p>C Kinetic back-up</p> <p>D Trip</p>                   |
| <p>A Normal operation</p> <p>B Mains failure</p>                          | <p>C Kinetic back-up</p> <p>D Trip</p>                   |  |   |  |
| [6]   | Alarm  |  |   |  |
| [7]   | Kin. back-up, trip w recovery                            | <p>This option is valid in VVC+ only. Kinetic back-up with recovery combines the features of kinetic back-up and kinetic back-up with trip. This feature makes it possible to select between kinetic back-up and kinetic back-up with trip, based on a recovery speed, configurable in <i>parameter 14-15 Kin. Back-up Trip Recovery Level</i>. If mains does not return, the drive ramps down to 0 RPM and trips. If mains returns while in kinetic back-up at a speed above the value in <i>parameter 14-15 Kin. Back-up Trip Recovery Level</i>, normal operation is resumed. This is equal to [4] Kinetic Back-up. The DC level during [7] Kin. back-up, trip w recovery is <i>parameter 14-11 Mains Fault Voltage Level</i> x 1.35.</p> <p><b>Illustration 85: Kinetic Back-up Trip w/Recovery, Mains Returns Above <i>Parameter 14-15 Kin. Back-up Trip Recovery Level</i></b></p>   |   |  |

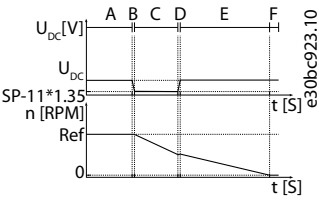
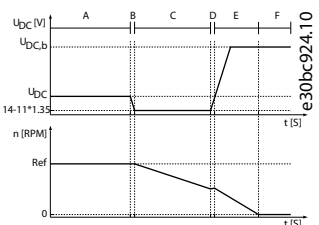
| Option | Name                   | Description   |                                  |                  |   |              |   |               |   |                           |   |                 |  |  |   |                  |   |              |   |               |   |                                  |   |                 |   |      |   |                  |   |              |   |               |   |                                 |   |                 |   |      |
|--------|------------------------|---|----------------------------------|------------------|---|--------------|---|---------------|---|---------------------------|---|-----------------|--|--|---|------------------|---|--------------|---|---------------|---|----------------------------------|---|-----------------|---|------|---|------------------|---|--------------|---|---------------|---|---------------------------------|---|-----------------|---|------|
|        |                        | <table border="1" data-bbox="304 331 1422 510"> <tr> <td>A</td> <td>Normal operation</td> <td>D</td> <td>Mains return</td> </tr> <tr> <td>B</td> <td>Mains Failure</td> <td>E</td> <td>Normal operation: Ramping</td> </tr> <tr> <td>C</td> <td>Kinetic back-up</td> <td></td> <td></td> </tr> </table> <p data-bbox="304 521 1422 611">If mains returns while in kinetic back-up at a speed below <i>parameter 14-15 Kin. Back-up Trip Recovery Level</i>, the drive ramps down to 0 RPM using the ramp and then trips. If the ramp is slower than the system ramping down on its own, the ramping is done mechanically and <math>U_{DC}</math> is at the normal level (<math>U_{DC,m} \times 1.35</math>).</p>  <p data-bbox="304 842 1422 902"><b>Illustration 86: Kinetic Back-up Trip w/Recovery, Slow Ramp, Mains Returns Below <i>Parameter 14-15 Kin. Back-up Trip Recovery Level</i></b></p> <table border="1" data-bbox="304 925 1422 1104"> <tr> <td>A</td> <td>Normal operation</td> <td>D</td> <td>Mains return</td> </tr> <tr> <td>B</td> <td>Mains failure</td> <td>E</td> <td>Kinetic back-up, ramping to trip</td> </tr> <tr> <td>C</td> <td>Kinetic back-up</td> <td>F</td> <td>Trip</td> </tr> </table> <p data-bbox="304 1115 1422 1176">If the ramp is quicker than the ramp-down speed of the application, the ramping generates current. This results in a higher <math>U_{DC}</math>, which is limited using the brake chopper/resistor brake.</p>  <p data-bbox="304 1433 1422 1494"><b>Illustration 87: Kinetic Back-up Trip w/Recovery, Quick Ramp, Mains Returns Below <i>Parameter 14-15 Kin. Back-up Trip Recovery Level</i></b></p> <table border="1" data-bbox="304 1516 1422 1695"> <tr> <td>A</td> <td>Normal operation</td> <td>D</td> <td>Mains return</td> </tr> <tr> <td>B</td> <td>Mains failure</td> <td>E</td> <td>Kinetic back-up ramping to trip</td> </tr> <tr> <td>C</td> <td>Kinetic back-up</td> <td>F</td> <td>Trip</td> </tr> </table> | A                                | Normal operation | D | Mains return | B | Mains Failure | E | Normal operation: Ramping | C | Kinetic back-up |  |  | A | Normal operation | D | Mains return | B | Mains failure | E | Kinetic back-up, ramping to trip | C | Kinetic back-up | F | Trip | A | Normal operation | D | Mains return | B | Mains failure | E | Kinetic back-up ramping to trip | C | Kinetic back-up | F | Trip |
| A      | Normal operation       | D   | Mains return                     |                  |   |              |   |               |   |                           |   |                 |  |  |   |                  |   |              |   |               |   |                                  |   |                 |   |      |   |                  |   |              |   |               |   |                                 |   |                 |   |      |
| B      | Mains Failure          | E   | Normal operation: Ramping        |                  |   |              |   |               |   |                           |   |                 |  |  |   |                  |   |              |   |               |   |                                  |   |                 |   |      |   |                  |   |              |   |               |   |                                 |   |                 |   |      |
| C      | Kinetic back-up        |   |                                  |                  |   |              |   |               |   |                           |   |                 |  |  |   |                  |   |              |   |               |   |                                  |   |                 |   |      |   |                  |   |              |   |               |   |                                 |   |                 |   |      |
| A      | Normal operation       | D   | Mains return                     |                  |   |              |   |               |   |                           |   |                 |  |  |   |                  |   |              |   |               |   |                                  |   |                 |   |      |   |                  |   |              |   |               |   |                                 |   |                 |   |      |
| B      | Mains failure          | E   | Kinetic back-up, ramping to trip |                  |   |              |   |               |   |                           |   |                 |  |  |   |                  |   |              |   |               |   |                                  |   |                 |   |      |   |                  |   |              |   |               |   |                                 |   |                 |   |      |
| C      | Kinetic back-up        | F   | Trip                             |                  |   |              |   |               |   |                           |   |                 |  |  |   |                  |   |              |   |               |   |                                  |   |                 |   |      |   |                  |   |              |   |               |   |                                 |   |                 |   |      |
| A      | Normal operation       | D   | Mains return                     |                  |   |              |   |               |   |                           |   |                 |  |  |   |                  |   |              |   |               |   |                                  |   |                 |   |      |   |                  |   |              |   |               |   |                                 |   |                 |   |      |
| B      | Mains failure          | E   | Kinetic back-up ramping to trip  |                  |   |              |   |               |   |                           |   |                 |  |  |   |                  |   |              |   |               |   |                                  |   |                 |   |      |   |                  |   |              |   |               |   |                                 |   |                 |   |      |
| C      | Kinetic back-up        | F   | Trip                             |                  |   |              |   |               |   |                           |   |                 |  |  |   |                  |   |              |   |               |   |                                  |   |                 |   |      |   |                  |   |              |   |               |   |                                 |   |                 |   |      |
| [9]    | Kinetic back-up, coast | <p data-bbox="304 1742 1422 1955">The purpose of this function is to avoid mains failure trips (<i>Alarm 36</i>), for example, where mains is weak or can be disturbed by other motors being started directly. When the drive detects mains failure, the drive ramps down the motor using kinetic back-up and coasts the drive. The drive remains coasted for the time set in <i>parameter 40-14 Mains Loss Duration</i> - the actual ramp-down time in KB. If mains returns after that time, the drive ramps up again. When <i>parameter 40-14 Mains Loss Duration</i> = 60, the drive immediately restarts the ramp up if the start command is still valid from PLC and mains voltage is back. When <i>parameter 40-14 Mains Loss Duration</i> = &lt;60, the drive waits for the timer in <i>parameter 40-14 Mains Loss Duration</i> to expire before restarting ramp up.</p>   |                                  |                  |   |              |   |               |   |                           |   |                 |  |  |   |                  |   |              |   |               |   |                                  |   |                 |   |      |   |                  |   |              |   |               |   |                                 |   |                 |   |      |



| Option | Name            | Description  |
|--------|-----------------|--|
|        |                 | This delay prevents an unintentional restart if the drive detects that mains is back at an acceptable level, but not being consistently back.  |
| [10]   | Quick ramp-down | The purpose of this function is to handle mains drop in low inertia applications, where the drive must continue running to make a ride-through by reducing the speed until the grid returns to full voltage. During the voltage drop, the speed ramps down using <i>parameter 3-81 Quick Stop Ramp Time</i> until voltage returns. After that, normal ramp up is used. The DC link is not regulated since this is not possible in a low-inertia application without any generative power in the motor/load. The selection is valid for IPM and SPM motors in Flux. To ensure that the function is activated, set <i>parameter 14-11 Mains Failure Voltage Level</i> higher than the expected voltage drop level. The quick ramp down must be set fast enough to endure a significant load drop to allow the control to run at reduced voltage, and it must be slow enough not to reach standstill before voltage returns - if possible. If speed reaches 0, it stays there until voltage returns and ramps up. If an alarm is required at standstill, it can be programmed in the SLC. An optional delay, set in <i>parameter 40-14 Mains Loss Duration</i> , can be activated before ramping up to bypass and ripple on the DC link when power returns. |

Parameter 14-11 Mains Fault Voltage Level

Table 709: Parameter 14-11 Mains Fault Voltage Level

| 14-11 Mains Fault Voltage Level |                                    |                               |
|---------------------------------|------------------------------------|-------------------------------|
| Default value: Size related     | Parameter type: Range, 100 - 800 V | Setup: All setups             |
| Conversion index: 0             | Data type: Uint16                  | Change during operation: True |

This parameter defines the threshold voltage at which the function in *parameter 14-10 Mains Failure* is activated. Select the detection level depending on the supply quality. For a supply of 380 V, set *parameter 14-11 Mains Fault Voltage Level* to 342 V. This results in a DC detection level of 462 V (*parameter 14-11 Mains Fault Voltage Level* x 1.35).

**NOTICE**

Converting from VLT 5000 to FC 300: Even though the setting of the mains voltage at mains fault is the same for VLT 5000 and FC 300, the detection level is different. Use the following formula to obtain the same detection level as in VLT 5000: *Parameter 14-11 Mains Fault Voltage Level* (VLT 5000 level) = value used in VLT 5000 x 1.35/sqrt(2).

Parameter 14-12 Response to Mains Imbalance

Table 710: Parameter 14-12 Response to Mains Imbalance

| 14-12 Response to Mains Imbalance |                        |                               |
|-----------------------------------|------------------------|-------------------------------|
| Default value: [0] Trip lock      | Parameter type: Option | Setup: All setups             |
| Conversion index: -               | Data type: Uint8       | Change during operation: True |

**NOTICE**

Make sure that the setting in *parameter 0-03 Regional Setting* matches the actual grid.

Operation under severe mains imbalance conditions reduces the lifetime of the motor. Conditions are considered severe if the motor is operated continuously near nominal load (for example, a pump or a fan running near full speed). Select the level of operation when mains imbalance conditions occur. Options [5] *Fast trip lock* to [7] *Fast warning* are based on a principle which ensures detection of a missing mains phase within 2 s and responds according to the selection. See *parameter 14-17 Fast Mains Phase Loss* and *parameter 14-18 Fast Mains Phase Loss Min Power*. A minimum load on the drive of 2% nominal power is required for detection of missing mains phase.

| Option | Name           | Description   |
|--------|----------------|---|
| [0]*   | Trip Lock      | A trip lock is triggered upon a mains phase imbalance.  |
| [1]    | Warning        | A warning is issued upon a mains phase imbalance.       |
| [2]    | Disabled       | Mains failure detection is disabled.                    |
| [3]    | Derate         | The drive derates upon a mains phase imbalance.         |
| [4]    | Trip           | The drive trips.  |
| [5]    | Fast Trip Lock | A trip lock occurs when a mains input phase is missing. |
| [6]    | Fast Trip      | The drive trips when a mains input phase is missing.    |
| [7]    | Fast Warning   | A warning occurs when a mains input phase is missing.   |

### Parameter 14-14 Kin. Back-up Time-up

Table 711: Parameter 14-14 Kin. Back-up Time-up

| 14-14 Kin. Back-up Time-up |                                 |                               |
|----------------------------|---------------------------------|-------------------------------|
| Default value: 60 s        | Parameter type: Range, 0 - 60 s | Setup: All setups             |
| Conversion index: 0        | Data type: Uint8                | Change during operation: True |

This parameter defines the kinetic back-up timeout in flux mode when running on low voltage grids. If the supply voltage does not exceed the value defined in *parameter 14-11 Mains Fault Voltage Level +5%* within the specified time, the drive automatically runs a controlled ramp-down profile before stop.

### Parameter 14-15 Kin. Back-up Trip Recovery Level

Table 712: Parameter 14-15 Kin. Back-up Trip Recovery Level

| 14-15 Kin. Back-up Trip Recovery Level |  |                               |
|--|--|-------------------------------|
| Default value: Size related            | Parameter type: Range, 0 - 60000.000 Reference- FeedbackUnit | Setup: All setups             |
| Conversion index: -3                   | Data type: Uint32  | Change during operation: True |

This parameter specifies the kinetic back-up trip recovery level. The unit is defined in *parameter 0-02 Motor Speed Unit*.

### Parameter 14-16 Kin. Back-up Gain

Table 713: Parameter 14-16 Kin. Back-up Gain

| 14-16 Kin. Back-up Gain |                                 |                               |
|-------------------------|---------------------------------|-------------------------------|
| Default value: 100%     | Parameter type: Range, 0 - 500% | Setup: All setups             |
| Conversion index: 0     | Data type: Uint32               | Change during operation: True |

Enter the kinetic back-up gain value in percent.

### Parameter 14-17 Fast Mains Phase Loss Level

Table 714: Parameter 14-17 Fast Mains Phase Loss Level

| 14-17 Fast Mains Phase Loss Level |                                |                               |
|-----------------------------------|--------------------------------|-------------------------------|
| Default value: 100                | Parameter type: Range, 0 - 500 | Setup: All setups             |
| Conversion index: -3              | Data type: Uint32              | Change during operation: True |

Set the level at which the functions Fast Mains Phase Loss Trip or Fast Mains Phase Loss Warning (see *parameter 14-12 Response to Mains Imbalance*) should be activated.

**NOTICE**

A lower level than default might cause false alarms as it increases sensitivity.

Parameter 14-18 Fast Mains Phase Loss Min Power

Table 715: Parameter 14-18 Fast Mains Phase Loss Min Power

| 14-18 Fast Mains Phase Loss Min Power |                                |                               |
|---------------------------------------|--------------------------------|-------------------------------|
| Default value: 2                      | Parameter type: Range, 0 - 100 | Setup: All setups             |
| Conversion index: -3                  | Data type: Uint32              | Change during operation: True |

Set the minimum power level (% of nominal power) at which the functions Fast Mains Phase Loss Trip or Fst Mains Phase Loss Warning (see *parameter 14-12 Response to Mains Imbalance*) should be activated.

**NOTICE**

A minimum power level of 2% is a prerequisite for the Fast Mains Phase Loss function to work.

### 5.14.3 14-2\* Trip Reset

Parameters for configuring auto reset handling, special trip handling, and control card self-test or initialization.

Parameter 14-20 Reset Mode

Table 716: Parameter 14-20 Reset Mode

| 14-20 Reset Mode                |                        |                               |
|---------------------------------|------------------------|-------------------------------|
| Default value: [0] Manual reset | Parameter type: Option | Setup: All setups             |
| Conversion index: -             | Data type: Uint8       | Change during operation: True |

Select the reset function after tripping. Once reset, the drive can be restarted.

**NOTICE**

The motor may start without warning. If the specified number of automatic resets is reached within 10 minutes, the drive enters [0] *Manual reset* mode. After the manual reset is performed, the setting of *parameter 14-20 Reset Mode* returns to the original selection. If the number of automatic resets are not reached within 10 minutes, or when a manual reset is performed, the internal automatic reset counter returns to 0.

| Option | Name                | Description  |
|--------|---------------------|--|
| [0]*   | Manual reset        | Select [0] <i>Manual reset</i> to perform a reset via [Reset] or via the digital inputs.           |
| [1]    | Automatic reset x 1 | Select [1]-[12] <i>Automatic reset</i> x 1... x20 to perform 1–20 automatic resets after tripping. |
| [2]    | Automatic reset x 2 |  |
| [3]    | Automatic reset x 3 |  |
| [4]    | Automatic reset x 4 |  |
| [5]    | Automatic reset x 5 |  |
| [6]    | Automatic reset x 6 |  |
| [7]    | Automatic reset x 7 |  |
| [8]    | Automatic reset x 8 |  |

| Option | Name                 | Description   |
|--------|----------------------|---|
| [9]    | Automatic reset x 9  |   |
| [10]   | Automatic reset x 10 |   |
| [11]   | Automatic reset x 15 |   |
| [12]   | Automatic reset x 20 |   |
| [13]   | Infinite auto reset  | Select this option for continuous resetting after tripping. |
| [14]   | Reset at power-up    |   |

Parameter 14-21 Automatic Restart Time

Table 717: Parameter 14-21 Automatic Restart Time

| 14-21 Automatic Restart Time |                                   |                               |
|------------------------------|-----------------------------------|-------------------------------|
| Default value: Size related  | Parameter type: Range, 0 - 3600 s | Setup: All setups             |
| Conversion index: 0          | Data type: Uint16                 | Change during operation: True |

Enter the time interval from trip to start of the automatic reset function. This parameter is active when *parameter 14-20 Reset Mode* is set to [1]–[13] *Automatic reset*.

Parameter 14-22 Operation Mode

Table 718: Parameter 14-22 Operation Mode

| 14-22 Operation Mode                |                        |                               |
|-------------------------------------|------------------------|-------------------------------|
| Default value: [0] Normal operation | Parameter type: Option | Setup: All setups             |
| Conversion index: -                 | Data type: Uint8       | Change during operation: True |

Use this parameter to specify normal operation, to perform tests, or to initialize all parameters except *parameter 15-03 Power Up's*, *parameter 15-04 Over Temp's*, and *parameter 15-05 Over Volt's*. This function is active only when the power is cycled to the drive. Select [0] *Normal operation* for normal operation of the drive with the motor in the selected application. Select [1] *Control card test* to test the analog and digital inputs and outputs and the +10 V control voltage. The test requires a test connector with internal connections. Use the following procedure for the control card test:

- Select [1] *Control card test*.
- Disconnect the mains supply and wait for the indicator light in the display to go out.
- Set switches S201 (A53) and S202 (A54) to ON/I.
- Insert the test plug.
- Connect to mains supply.
- Carry out various tests.
- The results are shown on the LCP and the drive moved into an infinite loop.
- *Parameter 14-22 Operation Mode* is automatically set to normal operation. Carry out a power cycle to start up in normal operation after a control card test.

|                   |  |
|-------------------|--|
| If the test is OK | LCP readout: Control card OK.<br>Disconnect the mains supply and remove the test plug. The green indicator light on the control card lights up.  |
| If the test fails | LCP readout: Control card I/O failure.<br>Replace the drive or control card. The red indicator light on the control card is turned on. Test plugs (connect the following terminals to each other): 18 - 27 - 32; 19 - 29 - 33; 42 - 53 - 54. |

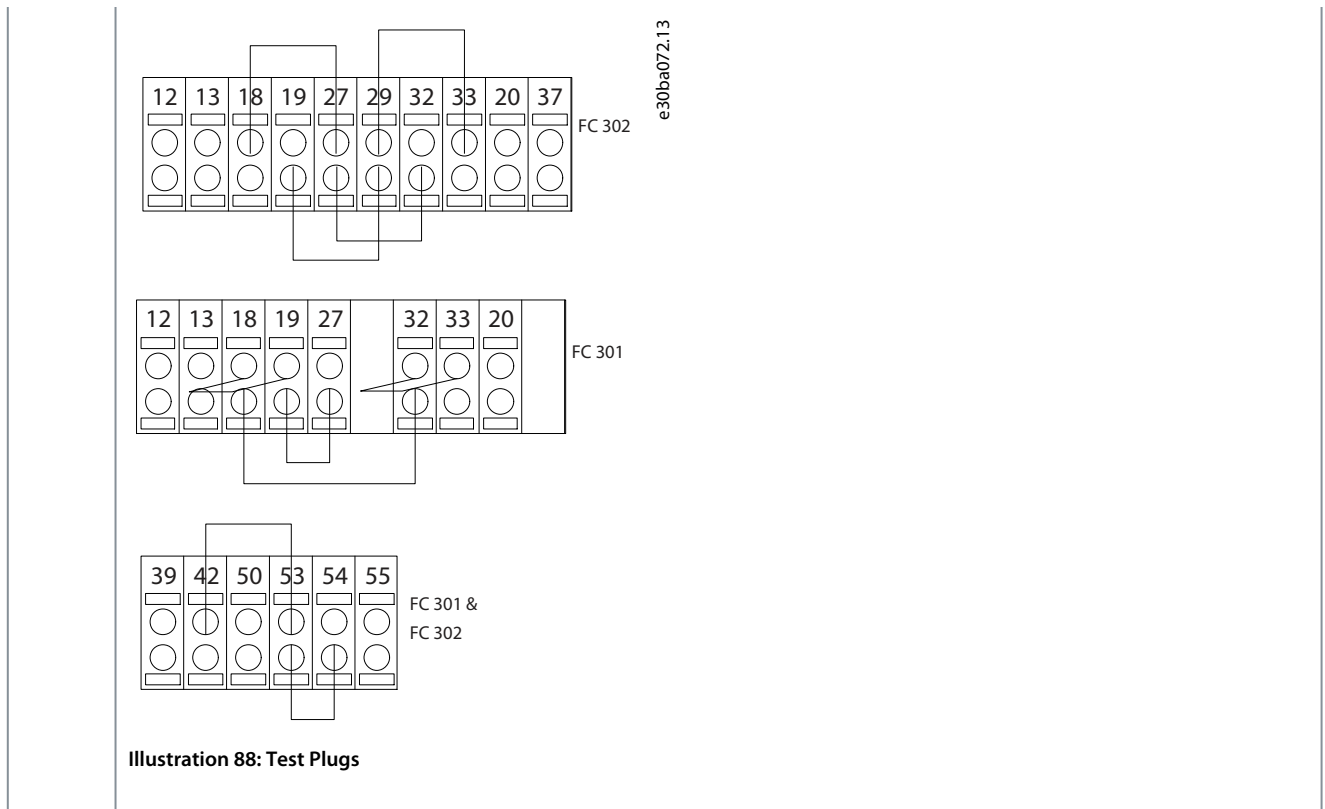

Illustration 88: Test Plugs

Select [2] *Initialisation* to reset all parameter values to default settings, except for: *Parameter 15-03 Power Up's*, *parameter 15-04 Over Temp's*, and *parameter 15-05 Over Volt's*. The drive resets during the next power-up. *Parameter 14-22 Operation Mode* also returns to the default setting [0] *Normal operation*.

| Option | Name               | Description  |
|--------|--------------------|--|
| [0]*   | Normal operation   |  |
| [1]    | Control card test  | Remember to set switches S201 (A53) and S202 (A54) as specified in the parameter description when performing a control card test. Otherwise, the test fails.   |
| [2]    | Initialisation     | Select this option to perform initialization. This option does not clear the service logs.   |
| [3]    | Boot mode          |  |
| [5]    | Clear service logs | <div style="text-align: center; background-color: #cccccc; padding: 5px;"><b>NOTICE</b></div> <p>Save the log information using MCT 10 Set-up Software before clearing the service logs.</p> <p>Select this option and perform a power cycle to clear the log.</p> |
| [6]    | Clear param. log   |  |

Parameter 14-24 Trip Delay at Current Limit

Table 719: Parameter 14-24 Trip Delay at Current Limit

| 14-24 Trip Delay at Current Limit |                                 |                               |
|-----------------------------------|---------------------------------|-------------------------------|
| Default value: 60 s               | Parameter type: Range, 0 - 60 s | Setup: All setups             |
| Conversion index: 0               | Data type: Uint8                | Change during operation: True |

Enter the current limit trip delay in s. When the output current reaches the current limit (*parameter 4-18 Current Limit*), a warning is triggered. When the current limit warning has been continuously present for the period specified in this parameter, the drive trips. To run continuously in current limit without tripping, set the parameter to 60 s. Thermal monitoring of the drive remains active.

Parameter 14-25 Trip Delay at Torque Limit

Table 720: Parameter 14-25 Trip Delay at Torque Limit

| 14-25 Trip Delay at Torque Limit |                                 |                               |
|----------------------------------|---------------------------------|-------------------------------|
| Default value: 60 s              | Parameter type: Range, 0 - 60 s | Setup: All setups             |
| Conversion index: 0              | Data type: Uint8                | Change during operation: True |

Enter the torque limit trip delay in s. When the output torque reaches the torque limits (*parameter 4-16 Torque Limit Motor Mode* and *parameter 4-17 Torque Limit Generator Mode*), a warning is triggered. When the torque limit warning has been continuously present for the period specified in this parameter, the drive trips. Disable the trip delay by setting the parameter to 60 s. Thermal monitoring of the drive remains active.

Parameter 14-26 Trip Delay at Inverter Fault

Table 721: Parameter 14-26 Trip Delay at Inverter Fault

| 14-26 Trip Delay at Inverter Fault |                                 |                               |
|------------------------------------|---------------------------------|-------------------------------|
| Default value: Size related        | Parameter type: Range, 0 - 35 s | Setup: All setups             |
| Conversion index: 0                | Data type: Uint8                | Change during operation: True |

When the drive detects an overvoltage in the set time, a trip is effected after the set time. If the value is 0, protection mode is disabled.

## N O T I C E

Disable protection mode in hoisting applications.

### 5.14.4 14-3\* Current Limit Control

## N O T I C E

The following parameters are only available in FC 302:

- *Parameter 14-33 Torque Change Detection*
- *Parameter 14-36 Field-weakening Function*
- *Parameter 14-37 Fieldweakening Speed*
- *Parameter 14-38 Field Weakening Controller Gain*
- *Parameter 14-39 Torque Change Threshold Limit*

The drive features an integral current limit controller, which is activated when the motor current, and thus the torque, is higher than the torque limits set in *parameter 4-16 Torque Limit Motor Mode* and *parameter 4-17 Torque Limit Generator Mode*. When the current limit is reached during motor operation or regenerative operation, the drive tries to reduce torque below the preset torque limits as quickly as possible without losing control of the motor. While the current control is active, the drive can only be stopped by setting a digital input to [2] *Coast inverse* or [3] *Coast and reset inv.* Any signals on terminals 18–33 are not active until the drive is no longer near the current limit. By using a digital input set to [2] *Coast inverse* or [3] *Coast and reset inv.*, the motor does not use the ramp-down time, since the drive is coasted. If a quick stop is necessary, use the mechanical brake control function along with an external electro-mechanical brake attached to the application.

## Parameter 14-30 Current Lim Ctrl, Proportional Gain

Table 722: Parameter 14-30 Current Lim Ctrl, Proportional Gain

| 14-30 Current Lim Ctrl, Proportional Gain |                                 |                                |
|---|---------------------------------|--------------------------------|
| Default value: 100%                       | Parameter type: Range, 0 - 500% | Setup: All setups              |
| Conversion index: 0                       | Data type: Uint16               | Change during operation: False |

Enter the proportional gain value for the current limit controller. Selection of a high value makes the controller react faster. Too high a setting leads to controller instability.

## Parameter 14-31 Current Lim Ctrl, Integration Time

Table 723: Parameter 14-31 Current Lim Ctrl, Integration Time

| 14-31 Current Lim Ctrl, Integration Time |                                    |                                |
|--|------------------------------------|--------------------------------|
| Default value: Size related              | Parameter type: Range, 0.002 - 2 s | Setup: All setups              |
| Conversion index: -3                     | Data type: Uint16                  | Change during operation: False |

Controls the current limit control integration time. Setting it to a lower value makes it react faster. A setting too low leads to controller instability.

## Parameter 14-32 Current Lim Ctrl, Filter Time

Table 724: Parameter 14-32 Current Lim Ctrl, Filter Time

| 14-32 Current Lim Ctrl, Filter Time |                                   |                               |
|-------------------------------------|-----------------------------------|-------------------------------|
| Default value: Size related         | Parameter type: Range, 1 - 100 ms | Setup: All setups             |
| Conversion index: -4                | Data type: Uint16                 | Change during operation: True |

Controls the current limit control low-pass filter. This makes it possible to react to peak values or to average values. When selecting average values, it is sometimes possible to run with higher output current and instead trip on the hardware limit for current. However, the control reacts slower as it does not react on immediate values.

## Parameter 14-33 Torque Change Detection

Table 725: Parameter 14-33 Torque Change Detection

| 14-33 Torque Change Detection |                        |                               |
|-------------------------------|------------------------|-------------------------------|
| Default value: [0] Disabled   | Parameter type: Option | Setup: All setups             |
| Conversion index: -           | Data type: Uint8       | Change during operation: True |

| Option | Name     | Description   |
|--------|----------|---|
| [0]*   | Disabled |   |
| [1]    | Enable   | Use this function in VVC+, flux, and in speed mode. The torque load is minimum 15% of nominal torque and the actual speed equals to the reference. <i>Parameter 14-39 Torque Change Threshold Limit</i> is used for threshold limit generation. |

## Parameter 14-34 Stall Protection Adjustment Factor

Table 726: Parameter 14-34 Stall Protection Adjustment Factor

| 14-34 Stall Protection Adjustment Factor |                                  |                               |
|--|----------------------------------|-------------------------------|
| Default value: 100%                      | Parameter type: Range, 50 - 200% | Setup: All setups             |
| Conversion index: -4                     | Data type: Uint16                | Change during operation: True |

Set this parameter to avoid overvoltage and overcurrent alarms occurring in the field-weakening area. Decrease the setting to reduce risk of overcurrent and overvoltage trips. Increase the setting if the stall protection is overprotecting and the torque is too low, for example, due to wrong motor data.

### N O T I C E

This parameter is active when *parameter 14-35 Stall Protection* is set to [1] Enabled and *parameter 14-36 Field-weakening Function* is set to [1] 1/x.

#### Parameter 14-35 Stall Protection

Table 727: Parameter 14-35 Stall Protection

| 14-35 Stall Protection     |                        |                                |
|----------------------------|------------------------|--------------------------------|
| Default value: [1] Enabled | Parameter type: Option | Setup: All setups              |
| Conversion index: -        | Data type: Uint8       | Change during operation: False |

### N O T I C E

This parameter is active in flux mode only.

| Option | Name     | Description  |
|--------|----------|--|
| [0]    | Disabled | Disables stall protection in field weakening flux mode and might cause the motor to be lost. |
| [1]*   | Enabled  | Enables stall protection in field weakening flux mode.                                       |

#### Parameter 14-36 Field-weakening Function

Table 728: Parameter 14-36 Field-weakening Function

| 14-36 Field-weakening Function |                        |                               |
|--------------------------------|------------------------|-------------------------------|
| Default value: [0] Auto        | Parameter type: Option | Setup: All setups             |
| Conversion index: -            | Data type: Uint8       | Change during operation: True |

Select the field-weakening function mode in flux mode.

| Option Number | Option Name | Description   |
|---------------|-------------|---|
| [0]*          | Auto        | In this mode, the drive calculates the optimal torque output. Measured DC-link voltage determines the phase-to-phase motor voltage. Magnetizing reference is based on the actual voltage and utilizes the information about the model of the motor. |
| [1]           | 1/x         | The drive reduces torque output. The drive sets the magnetizing reference inversely proportional to the speed using a static curve that shows the relationship between DC-link voltage and the speed.   |

#### Parameter 14-37 Fieldweakening Speed

Table 729: Parameter 14-37 Fieldweakening Speed

| 14-37 Fieldweakening Speed  |                                       |                               |
|-----------------------------|---------------------------------------|-------------------------------|
| Default value: Size related | Parameter type: Range, 10 - 60000 RPM | Setup: All setups             |
| Conversion index: 67        | Data type: Uint16                     | Change during operation: True |

Enter the start speed for option [1] [1/x] in *parameter 14-36 Fieldweakening Function*.



## Parameter 14-38 Field Weakening Controller Gain

Table 730: Parameter 14-38 Field Weakening Controller Gain

| 14-38 Field Weakening Controller Gain |                                  |                               |
|---------------------------------------|----------------------------------|-------------------------------|
| Default value: 20%                    | Parameter type: Range, 10 - 100% | Setup: All setups             |
| Conversion index: 0                   | Data type: Uint16                | Change during operation: True |

Set the integral gain for the field weakening controller.  
Parameter 14-39 Torque Change Threshold Limit

Table 731: Parameter 14-39 Torque Change Threshold Limit

| 14-39 Torque Change Threshold Limit |                                  |                               |
|-------------------------------------|----------------------------------|-------------------------------|
| Default value: 20%                  | Parameter type: Range, 10 - 100% | Setup: All setups             |
| Conversion index: 67                | Data type: Uint16                | Change during operation: True |

Set the torque change threshold limit in % of the actual torque. When the actual torque exceeds the torque threshold value, the drive trips within 10 ms.

## 5.14.5 14-4\* Energy Optimizing

Parameters for adjusting the energy optimization level in both variable torque (VT) and automatic energy optimization (AEO) mode in *parameter 1-03 Torque Characteristics*.

## Parameter 14-40 VT Level

Table 732: Parameter 14-40 VT Level

| 14-40 VT Level      |                                 |                                |
|---------------------|---------------------------------|--------------------------------|
| Default value: 66%  | Parameter type: Range, 40 - 90% | Setup: All setups              |
| Conversion index: 0 | Data type: Uint8                | Change during operation: False |

## NOTICE

This parameter cannot be adjusted while the motor is running.

## NOTICE

This parameter is not active when *parameter 1-10 Motor Construction* is set to [1] PM non-salient SPM.

Enter the level of motor magnetization at low speed. Selection of a low value reduces energy loss in the motor but also reduces load capability.

## Parameter 14-41 AEO Minimum Magnetisation

Table 733: Parameter 14-41 AEO Minimum Magnetisation

| 14-41 AEO Minimum Magnetisation |                                  |                               |
|---------------------------------|----------------------------------|-------------------------------|
| Default value: Size related     | Parameter type: Range, 30 - 200% | Setup: All setups             |
| Conversion index: 0             | Data type: Uint8                 | Change during operation: True |

## NOTICE

This parameter is not active when *parameter 1-10 Motor Construction* is set to [1] PM non-salient SPM.

Enter the minimum allowable magnetization for AEO. Selection of a low value reduces energy loss in the motor but can also reduce resistance to sudden load changes.

## Parameter 14-42 Minimum AEO Frequency

Table 734: Parameter 14-42 Minimum AEO Frequency

| 14-42 Minimum AEO Frequency |                                   |                               |
|-----------------------------|-----------------------------------|-------------------------------|
| Default value: Size related | Parameter type: Range, 0 - 255 Hz | Setup: All setups             |
| Conversion index: 0         | Data type: Uint8                  | Change during operation: True |

## N O T I C E

This parameter is not active when *parameter 1-10 Motor Construction* is set to [1] *PM non-salient SPM*.

Enter the minimum frequency at which the automatic energy optimization (AEO) is to be active.

## Parameter 14-43 Motor Cosphi

Table 735: Parameter 14-43 Motor Cosphi

| 14-43 Motor Cosphi          |                                    |                               |
|-----------------------------|------------------------------------|-------------------------------|
| Default value: Size related | Parameter type: Range, 0.40 - 0.95 | Setup: All setups             |
| Conversion index: -2        | Data type: Uint16                  | Change during operation: True |

The Cos(phi) setpoint is automatically set for optimum AEO performance. This parameter should normally not be altered. However, in some situations it may be necessary to enter a new value to fine-tune.

## Parameter 14-44 d-axis Reference Gain

Table 736: Parameter 14-44 d-axis Reference Gain

| 14-44 d-axis Reference Gain |                                 |                               |
|-----------------------------|---------------------------------|-------------------------------|
| Default value: 100%         | Parameter type: Range, 0 - 200% | Setup: All setups             |
| Conversion index: 0         | Data type: Uint8                | Change during operation: True |

Adjustment parameter for the d-axis current. 100% indicates maximum torque per ampere value based on motor parameters. Increasing the maximum torque can improve the power factor of the machine, which may increase the current consumption. The adjustment parameter allows to:

- Adjust minimum current consumption, allowing for tolerances in the motor parameters.
- Obtain the optimal balance between current consumption and power factor of the machine at a given point of operation.

## Parameter 14-46 PROFIEnergy Times

Table 737: Parameter 14-46 PROFIEnergy Times

| 14-46 PROFIEnergy Times     |   |                               |
|-----------------------------|---|-------------------------------|
| Default value: Size related | Parameter type: Range, 0 - 0x7ffffff, Array [3] | Setup: All setups             |
| Conversion index: 0         | Data type: Uint32                               | Change during operation: True |

Parameter with an array of 3. [0] *Time to pause*, [1] *Time min stay*, [2] *Time regular operate*.

## Parameter 14-47 PROFIEnergy State

Table 738: Parameter 14-47 PROFIEnergy State

| 14-47 PROFIEnergy State               |                        |                                |
|---------------------------------------|------------------------|--------------------------------|
| Default value: [255] Ready to operate | Parameter type: Option | Setup: 2 setups                |
| Conversion index: -                   | Data type: Uint8       | Change during operation: False |

| Option | Name             | Description |
|--------|------------------|-------------|
| [1]    | LCP off          |             |
| [4]    | Internal fan off |             |
| [7]    | Gatedrive off    |             |
| [10]   | Mains off        |             |
| [13]   | External fan off |             |
| [255]* | Ready to operate |             |

## Parameter 14-48 PROFIEnergy Desired State

Table 739: Parameter 14-48 PROFIEnergy Desired State

| 14-48 PROFIEnergy Desired State       |                        |                                |
|---------------------------------------|------------------------|--------------------------------|
| Default value: [255] Ready to operate | Parameter type: Option | Setup: 2 setups                |
| Conversion index: -                   | Data type: Uint8       | Change during operation: False |

| Option | Name             | Description |
|--------|------------------|-------------|
| [1]    | LCP off          |             |
| [4]    | Internal fan off |             |
| [7]    | Gatedrive off    |             |
| [10]   | Mains off        |             |
| [13]   | External fan off |             |
| [255]* | Ready to operate |             |

## Parameter 14-49 PROFIEnergy Info

Table 740: Parameter 14-49 PROFIEnergy Info

| 14-49 PROFIEnergy Info |   |                               |
|------------------------|---|-------------------------------|
| Default value: 0       | Parameter type: Range, 0 - 0x7ffffff, Array [115] | Setup: All setups             |
| Conversion index: 0    | Data type: Uint32                                 | Change during operation: True |

Read-out information about PROFIEnergy.

### 5.14.6 14-5\* Environment

#### AMA and Motor Filters

The following table details the recommended AMA options when motor filters are connected between drive and motor. AMA is independent of the selection made in *parameter 1-00 Configuration Mode* and *parameter 1-01 Motor Control Principle*.

Table 741: Motor Filter Types

| Motor construction | Filter type               |  |
|--------------------|---------------------------|--|
|                    | MCC 102 dU/dt Filters     | MCC 101 Sine-wave Filters and MCC 201 All-mode Filters |
|                    | Valid P1-29 AMA options   |  |
| ASM and SPM        | [1] Complete AMA          | [2] Reduced AMA  |
|                    | [2] Reduced AMA           | [4] Enable reduced AMA II                              |
|                    | [4] Enable reduced AMA II | –  |
| IPM                | [1] Complete AMA          | [2] Reduced AMA  |
|                    | [2] Reduced AMA           | AMA II not available                                   |
|                    | AMA II not available      | –  |

**NOTICE**

The following parameter is only available in FC 302:

- Parameter 14-59 Actual Number of Inverter Units

**NOTICE**

Perform a power cycle after changing any of the parameters in this parameter group.

Use these parameters when operating the drive under special environmental conditions.

Parameter 14-50 RFI Filter

Table 742: Parameter 14-50 RFI Filter

| 14-50 RFI Filter      |                        |                                |
|-----------------------|------------------------|--------------------------------|
| Default value: [1] On | Parameter type: Option | Setup: 1 setup                 |
| Conversion index: -   | Data type: Uint8       | Change during operation: False |

Turn the RFI filter on or off. The RFI filter ensures that the drive complies with EMC standards. Select [0] Off only when the drive is connected to an isolated mains source (IT mains).

| Option | Name | Description |
|--------|------|-------------|
| [0]    | Off  |             |
| [1]*   | On   |             |

Parameter 14-51 DC-link Compensation

Table 743: Parameter 14-51 DC-link Compensation

| 14-51 DC-link Compensation |                        |                               |
|----------------------------|------------------------|-------------------------------|
| Default value: [1] On      | Parameter type: Option | Setup: All setups             |
| Conversion index: -        | Data type: Uint8       | Change during operation: True |

The rectified AC-DC voltage in the DC link of the drive is associated with voltage ripples. These ripples can increase in magnitude with increased load. These ripples are undesirable because they can generate current and torque ripples. A compensation method is used to reduce these voltage ripples in the DC link. In general, DC-link compensation is recommended for most applications, but pay attention when operating in field weakening as it can generate speed oscillations at the motor shaft. In field weakening, turn off DC-link compensation.

| Option | Name     | Description  |
|--------|----------|--|
| [0]    | Off      | Disables DC-link compensation.   |
| [1]*   | On       | Enables DC-link compensation.  |
| [2]    | Advanced | Improved compensation of DC-link ripple caused by mains frequency and phase imbalance.<br><br><div style="text-align: center; background-color: #cccccc; padding: 5px;"><b>NOTICE</b></div> <i>Parameter 0-03 Regional Setting must be set correctly according to the actual mains grid.</i> |

## Parameter 14-52 Fan Control

Table 744: Parameter 14-52 Fan Control

| 14-52 Fan Control       |                        |                               |
|-------------------------|------------------------|-------------------------------|
| Default value: [0] Auto | Parameter type: Option | Setup: All setups             |
| Conversion index: -     | Data type: Uint8       | Change during operation: True |

Select the minimum speed of the main fan.

| Option | Name                 | Description   |
|--------|----------------------|---|
| [0]*   | Auto                 | Select [0] Auto to run fan only when internal temperature in the drive is in the range 35 °C (95 °F) to approximately 55 °C (131 °F). The fan runs at low speed below 35 °C (95 °F), and at full speed at approximately 55 °C (131 °F).   |
| [1]    | On 50%               | The fan always runs at 50% speed or above. The fan runs at 50% speed at 35 °C (95 °F), and at full speed at approximately 55 °C (131 °F).   |
| [2]    | On 75%               | The fan always runs at 75% speed or above. The fan runs at 75% speed at 35 °C (95 °F), and at full speed at approximately 55 °C (131 °F).   |
| [3]    | On 100%              | The fan always runs at 100% speed.  |
| [4]    | Auto (Low temp env.) | This option is the same as [0] Auto, but with special considerations around and below 0 °C (32 °F). In option [0] Auto there is a risk that the fan starts running around 0 °C as the drive detects a sensor fault and thus protects the drive while reporting <i>warning 66, Heat sink Temperature Low</i> . Option [4] Auto (Low temp env.) can be used in very cold environments and prevents the negative effects of this further cooling and avoids <i>warning 66, Heat sink Temperature Low</i> . |

## Parameter 14-53 Fan Monitor

Table 745: Parameter 14-53 Fan Monitor

| 14-53 Fan Monitor          |                        |                               |
|----------------------------|------------------------|-------------------------------|
| Default value: [1] Warning | Parameter type: Option | Setup: All setups             |
| Conversion index: -        | Data type: Uint8       | Change during operation: True |

Select the drive action if a fan fault is detected.

| Option | Name     | Description |
|--------|----------|-------------|
| [0]    | Disabled |             |
| [1]*   | Warning  |             |
| [2]    | Trip     |             |

Parameter 14-55 Output Filter

Table 746: Parameter 14-55 Output Filter

| 14-55 Output Filter          |                        |                                |
|------------------------------|------------------------|--------------------------------|
| Default value: [0] No filter | Parameter type: Option | Setup: All setups              |
| Conversion index: -          | Data type: Uint8       | Change during operation: False |

**⚠ CAUTION ⚠**

**OVERHEATING OF FILTER OR AC DRIVE**

Incorrect setting of *parameter 14-55 Output Filter* can lead to overheating and cause equipment damage and personal injury.

- Always set *parameter 14-55 Output Filter* to [2] *Sine-wave fixed* when using a sine-wave filter.

**NOTICE**

This parameter cannot be adjusted while the motor is running.

**NOTICE**

Reset the drive after selecting [2] *Sine-wave filter fixed*.

Select the type of output filter connected.

| Op-tion | Name                   | Description   |
|---------|------------------------|---|
| [0]*    | No filter              | Set the parameter when VLT® MCC 102 dU/dt filters or VLT® MCC 105 high-frequency common-mode filters are connected to the drive.  |
| [1]     | Sine-wave filter       | <div style="text-align: center;"><b>NOTICE</b></div> <p><b>COMPATIBILITY SETTING</b><br/>Set the option to support backward compatibility with the VLT® 5000–8000 Series drives.</p> <ul style="list-style-type: none"> <li>- Do not use the setting when VLT® MCC 101 Sine-wave Filters and VLT® MCC 201 All-mode Filters are connected.</li> </ul> <p>Use the setting for backward compatibility purposes. Set <i>parameter 14-56 Capacitance Output Filter</i> and <i>parameter 14-57 Inductance Output Filter</i>. Setting the parameter does not limit the range of the switching frequency.</p>   |
| [2]     | Sine-Wave Filter Fixed | <div style="text-align: center;"><b>NOTICE</b></div> <p><b>SINE-WAVE FILTER FIXED SETTING</b><br/>Ensures that the filter is operated within the safe range of switching frequencies.</p> <ul style="list-style-type: none"> <li>- Use the setting only for VLT® MCC 101 Sine-wave Filters.</li> </ul> <p>When setting the option for VLT® MCC 101 Sine-wave filters, the parameter sets a minimum allowed limit to the switching frequency and ensures the filter is operated within the safe range of switching frequencies. The option supports all control principle operations of the filter. Set <i>parameter 14-56 Capacitance Output Filter</i> and</p> |

| Option | Name            | Description  |
|--------|-----------------|--|
|        |                 | <i>parameter 14-57 Inductance Output Filter</i> . Setting the option allows the modulation pattern to be set to stator flux asynchronous vector modulation (SFAVM), which reduces the acoustic switching noise from the filter.  |
| [5]    | All-mode Filter | <div style="text-align: center; background-color: #cccccc; padding: 5px;"><b>NOTICE</b></div> <p>This option is only available in FC 302.</p> <div style="text-align: center; background-color: #cccccc; padding: 5px;"><b>NOTICE</b></div> <p><b>ALL-MODE FILTERING</b><br/>Enables all-mode filter operating condition and ensures that the filter is operated within the safe range of switching frequencies.</p> <ul style="list-style-type: none"> <li>– Use this setting only for VLT® MCC 201 All-Mode Filters.</li> </ul> <p>When setting the option for VLT® MCC 201 All-mode Filter, the parameter enables all-mode filter operating conditions, which include settings for a minimum allowed limit to the switching frequency and ensure the filter is operated within the safe range of switching frequencies.</p> <p>The option supports all control principle operations of the filter. Set <i>Parameter 14-56 Capacitance Output Filter</i> and <i>parameter 14-57 Inductance Output Filter</i>.</p> <p>Setting the option allows the modulation pattern to be set to stator flux asynchronous vector modulation (SFAVM), which reduces the acoustic switching noise from the filter.</p> |

Parameter 14-56 Capacitance Output Filter

Table 747: Parameter 14-56 Capacitance Output Filter

| 14-56 Capacitance Output Filter |                                      |                                |
|---------------------------------|--------------------------------------|--------------------------------|
| Default value: 2.0 uF           | Parameter type: Range, 0.1 - 6500 uF | Setup: All setups              |
| Conversion index: -             | Data type: Uint16                    | Change during operation: False |

Set the  $C_y$  (capacitance) value of the output filter in uF, when using VLT® MCC 101 Sine-wave filter and VLT® MCC 201 All-mode filter. See the filter product label for the capacitance value. The value is the equivalent star-connected capacitance of the filter. When the filters are installed in parallel, enter the combined capacitance value of the paralleled filter. The value is the equivalent star-connected capacitance ( $C_y$ ) of the filter multiplied by the number of installed paralleled filters.

**NOTICE**

**SETTING FOR VLT® MCC 101 SINE-WAVE FILTER AND VLT® MCC 201 ALL-MODE FILTER**  
Enables accurate flux compensation when option [2] Flux sensorless or option [3] Flux w/motor feedback is selected in *parameter 1-01 Motor Control Principle*.

- Enter the correct capacitance value of the connected filter.

Parameter 14-57 Inductance Output Filter

Table 748: Parameter 14-57 Inductance Output Filter

| 14-57 Inductance Output Filter |                                   |                                |
|--------------------------------|-----------------------------------|--------------------------------|
| Default value: 7               | Parameter type: Range, 0.1 - 6500 | Setup: All setups              |
| Conversion index: -            | Data type: Uint16                 | Change during operation: False |

Set the inductance of the output filter in mH, when using VLT® MCC 101 Sine-wave Filter and VLT® MCC 201 All-mode Filter. See the product label of the filter for the value of inductance. When filters are installed in parallel, enter the combined inductance value of

the installed paralleled filters. The inductance value in the parameter is the inductance value of the filter divided by the number of paralleled filters.

**N O T I C E**

**SETTING FOR VLT® MCC 201 ALL-MODE AND VLT® MCC 101 SINE-WAVE FILTERS**

Enables accurate flux control compensation when option [2] *Flux Sensorless* or option [3] *Flux w/Motor Feedback* is selected in parameter 1-01 *Motor Control Principle*.

- Enter the correct inductance value of the connected filter.

Parameter 14-59 Actual Number of Inverter Units

Table 749: Parameter 14-59 Actual Number of Inverter Units

| 14-59 Actual Number of Inverter Units |                              |                                |
|---------------------------------------|------------------------------|--------------------------------|
| Default value: Size related           | Parameter type: Range, 1 - 1 | Setup: All setups              |
| Conversion index: 0                   | Data type: Uint8             | Change during operation: False |

Set the actual number of power units.

### 5.14.7 14-6\* Auto Derate

This parameter group contains parameters for derating the drive if there is high temperature.

Parameter 14-60 Function at Over Temperature

Table 750: Parameter 14-60 Function at Over Temperature

| 14-60 Function at Over Temperature |                        |                               |
|------------------------------------|------------------------|-------------------------------|
| Default value: [0] Trip            | Parameter type: Option | Setup: All setups             |
| Conversion index: -                | Data type: Uint8       | Change during operation: True |

If either heat sink or control card temperature exceeds a factory-programmed temperature limit, a warning is activated. If the temperature increases further, select whether the drive should trip (trip lock) or derate the output current.

| Option | Name   | Description  |
|--------|--------|--|
| [0]*   | Trip   | The drive trips (trip lock) and generates an alarm. Cycle power to reset the alarm. The motor restarts when the heat sink temperature has dropped below the alarm limit. |
| [1]    | Derate | If the critical temperature is exceeded, the output current is reduced until the allowable temperature has been reached.   |

#### No trip at inverter overload

In some systems, the drive has not been sized properly to yield the current needed in all points of the operational flow-head characteristic. At these points, the motor needs a current higher than the rated current of the drive. The drive can yield 110% of the rated current continuously for 60 s. If still overloaded, the drive normally trips (causing the motor to stop by coasting) and issues an alarm.



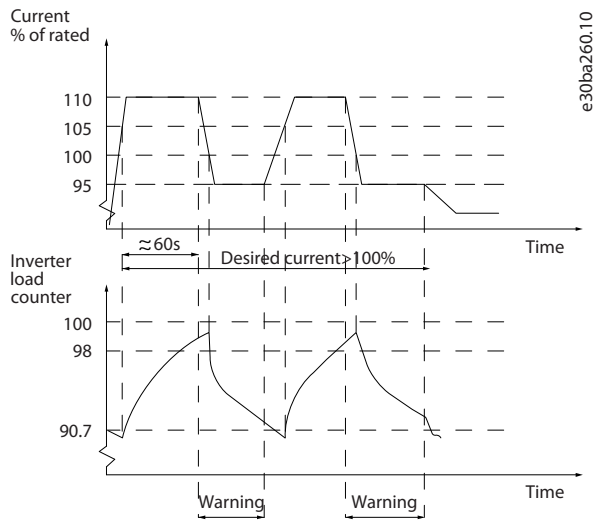

Illustration 89: Output Current in Overload Condition

If the motor is unable to run continuously with the demanded capacity, run it at reduced speed for a while.

Select *parameter 14-61 Function at Inverter Overload* to automatically reduce motor speed until the output current is below 100% of the rated current (set in *parameter 14-62 Inv. Overload Derate Current*). *Parameter 14-61 Function at Inverter Overload* is an alternative to letting the drive trip.

The drive estimates the load on the power section with an inverter load counter, which causes a warning at 98% and a reset of the warning at 90%. At the value 100%, the drive trips and issues an alarm. Status for the counter can be read in *parameter 16-35 Inverter Thermal*.

If *parameter 14-61 Function at Inverter Overload* is set to [3] Derate, the motor speed is reduced when the counter exceeds 98%, and stays reduced until the counter has dropped below 90.7%. If *parameter 14-62 Inv. Overload Derate Current* is set to for example 95%, a steady overload causes the pump speed to fluctuate between values corresponding to 110% and 95% of rated output current for the drive.

Parameter 14-61 Function at Inverter Overload

Table 751: Parameter 14-61 Function at Inverter Overload

| 14-61 Function at Inverter Overload |                        |                               |
|-------------------------------------|------------------------|-------------------------------|
| Default value: [0] Trip             | Parameter type: Option | Setup: All setups             |
| Conversion index: -                 | Data type: Uint8       | Change during operation: True |

Use if there is a steady overload beyond the thermal limits (110% for 60 s).

| Option | Name   | Description   |
|--------|--------|---|
| [0]*   | Trip   | Select [0] Trip to make the drive trip and issue an alarm.                                      |
| [1]    | Derate | Reduces the motor speed to decrease the load on the power section and allowing it to cool down. |

Parameter 14-62 Inv. Overload Derate Current

Table 752: Parameter 14-62 Inv. Overload Derate Current

| 14-62 Inv. Overload Derate Current |                                  |                               |
|------------------------------------|----------------------------------|-------------------------------|
| Default value: 95%                 | Parameter type: Range, 50 - 100% | Setup: All setups             |
| Conversion index: 0                | Data type: Uint16                | Change during operation: True |

Enter the current level (in % of rated output current for the drive) when running with reduced motor speed after load on the drive has exceeded the allowable limit (110% for 60 s).

### 5.14.8 14-7\* Compatibility

Parameters for compatibility of VLT 3000 and VLT 5000 with FC 300.

Parameter 14-72 Legacy Alarm Word

Table 753: Parameter 14-72 Legacy Alarm Word

| 14-72 Legacy Alarm Word |                                       |                                |
|-------------------------|---------------------------------------|--------------------------------|
| Default value: 0        | Parameter type: Range, 0 - 4294967295 | Setup: All setups              |
| Conversion index: 0     | Data type: Uint32                     | Change during operation: False |

Readout of the alarm word corresponding to VLT 5000.

Parameter 14-73 Legacy Warning Word

Table 754: Parameter 14-73 Legacy Warning Word

| 14-73 Legacy Warning Word |                                       |                                |
|---------------------------|---------------------------------------|--------------------------------|
| Default value: 0          | Parameter type: Range, 0 - 4294967295 | Setup: All setups              |
| Conversion index: 0       | Data type: Uint32                     | Change during operation: False |

Readout of the warning word corresponding to VLT 5000.

Parameter 14-74 Leg. Ext. Status Word

Table 755: Parameter 14-74 Leg. Ext. Status Word

| 14-74 Leg. Ext. Status Word |                                       |                                |
|-----------------------------|---------------------------------------|--------------------------------|
| Default value: 0            | Parameter type: Range, 0 - 4294967295 | Setup: All setups              |
| Conversion index: 0         | Data type: Uint32                     | Change during operation: False |

Readout of the external status word corresponding to VLT 5000.

### 5.14.9 14-8\* Options

Parameter 14-80 Option Supplied by External 24VDC

Table 756: Parameter 14-80 Option Supplied by External 24VDC

| 14-80 Option Supplied by External 24VDC |                        |                                |
|---|------------------------|--------------------------------|
| Default value: [1] Yes                  | Parameter type: Option | Setup: 2 setups                |
| Conversion index: -                     | Data type: Uint8       | Change during operation: False |

## N O T I C E

To make the parameter change function, perform a power cycle.

| Option | Name | Description   |
|--------|------|---|
| [0]    | No   | Select this option to use the 24 V DC supply of the drive.  |
| [1]*   | Yes  | Select this option if a 24 V DC external supply is used to power the option. Inputs/outputs are galvanically isolated from the drive when operated from an external supply. |

Parameter 14-88 Option Data Storage

Table 757: Parameter 14-88 Option Data Storage

| 14-88 Option Data Storage |  |                               |
|---------------------------|--|-------------------------------|
| Default value: 0          | Parameter type: Range, 0 - 65535, Array [24] | Setup: 2 setups               |
| Conversion index: 0       | Data type: Uint16                            | Change during operation: True |

This parameter stores information about options over a power cycle.

Parameter 14-89 Option Detection

Table 758: Parameter 14-89 Option Detection

| 14-89 Option Detection                    |                        |                               |
|---|------------------------|-------------------------------|
| Default value: [0] Protect option config. | Parameter type: Option | Setup: 1 setup                |
| Conversion index: -                       | Data type: Uint8       | Change during operation: True |

Selects the behavior of the drive when a change in the option configuration is detected.

| Option | Name                   | Description  |
|--------|------------------------|--|
| [0]*   | Protect option config. | Freezes the current settings and prevents unwanted changes when missing or defective options are detected.   |
| [1]    | Enable option change   | Changes drive settings and is used when modifying the system configuration. This parameter setting returns to [0] Protect option config. after an option change. |

### 5.14.10 14-9\* Fault Settings

Parameter 14-90 Fault Level

Table 759: Parameter 14-90 Fault Level

| 14-90 Fault Level           |                                    |                               |
|-----------------------------|------------------------------------|-------------------------------|
| Default value: Size related | Parameter type: Option, Array [28] | Setup: 1 setup                |
| Conversion index: -         | Data type: Uint8                   | Change during operation: True |

This is an array parameter with 26 elements. Each of the bits can be configured to any of the following options. Use this parameter to customize fault levels.

| Option | Name                  | Description  |
|--------|-----------------------|--|
| [0]    | Off                   | Use [0] Off with caution as it ignores all warnings and alarms for the selected source.  |
| [1]    | Warning               |  |
| [2]    | Trip                  | Changing a fault level from default option [3] Trip Lock to [2] Trip leads to the automatic reset of the alarm. For alarms involving overcurrent, the drive has a hardware protection that issues a 3-minute recovery after 2 consecutive overcurrent incidents. This hardware protection cannot be overruled.                     |
| [3]    | Trip lock             |  |
| [4]    | Trip w. delayed reset | This option adds a delay between automatic resets, otherwise it is the same as option [2] Trip. The delay prevents a situation where reset is attempted repeatedly for an overcurrent situation. Hardware protection of the drive forces the 3-minute recovery time after 2 consecutive overcurrents (within a short time window). |

Table 760: Selection of Action when Selected Alarm Appears

| Failure                                    | Alarm | Element in parameter 14-90 Fault Level | Off | Warning        | Trip | Trip lock | Trip with delayed reset |
|--|-------|--|-----|----------------|------|-----------|-------------------------|
| 10 V low                                   | 1     | 1490.0                                 | X   | D              | –    | –         | –                       |
| 24 V supply low                            | 47    | 1490.1                                 | X   | –              | –    | D         | –                       |
| 1.8 V supply low                           | 48    | 1490.2                                 | X   | –              | –    | D         | –                       |
| Voltage limit                              | 64    | 1490.3                                 | X   | D              | –    | –         | –                       |
| Ground fault during ramping                | 14    | 1490.4                                 | –   | –              | D    | X         | –                       |
| Ground fault 2 during continuous operation | 45    | 1490.5                                 | –   | –              | D    | X         | –                       |
| Torque limit                               | 12    | 1490.6                                 | X   | D              | –    | –         | –                       |
| Overcurrent                                | 13    | 1490.7                                 | –   | –              | X    | D         | –                       |
| Short circuit                              | 16    | 1490.8                                 | –   | –              | X    | D         | –                       |
| Heat sink temperature                      | 29    | 1490.9                                 | –   | –              | X    | D         | –                       |
| Heat sink sensor                           | 39    | 1490.10                                | –   | –              | X    | D         | –                       |
| Control card temperature                   | 65    | 1490.11                                | –   | –              | X    | D         | –                       |
| Power card temperature                     | 69    | 1490.12                                | –   | <sup>(1)</sup> | X    | D         | –                       |
| Heat sink temperature <sup>(2)</sup>       | 244   | 1490.13                                | –   | –              | X    | D         | –                       |
| Heat sink sensor <sup>(2)</sup>            | 245   | 1490.14                                | –   | –              | X    | D         | –                       |
| Power card temperature <sup>(2)</sup>      | 247   | 1490.15                                | –   | –              | X    | D         | –                       |
| Motor phase U missing                      | 30    | 1490.16                                | –   | –              | X    | D         | –                       |
| Motor phase V missing                      | 31    | 1490.16                                | –   | –              | X    | D         | –                       |
| Motor phase W missing                      | 32    | 1490.16                                | –   | –              | X    | D         | –                       |
| Derag limit fault                          | 100   | 1490.17                                | –   | –              | –    | D         | –                       |
| Inverter overload                          | 9     | 1490.18                                | –   | –              | –    | D         | –                       |
| Current limit <sup>(3)</sup>               | 59    | 1490.19                                | X   | D              | –    | –         | –                       |
| Locked rotor                               | 99    | 1490.20                                | –   | –              | D    | X         | –                       |
| AIC earth fault                            | 407   | 1490.21                                | X   | X              | X    | D         | X                       |
| DC-link voltage out of range               | 404   | 1490.22                                | X   | X              | X    | D         | X                       |
| Mains contactor fault                      | 300   | 1490.23                                | X   | X              | X    | D         | X                       |
| Not used                                   | x     | 1490.24                                | X   | X              | X    | D         | X                       |

| Failure        | Alarm | Element in parameter 14-90 Fault Level | Off | Warning | Trip | Trip lock | Trip with delayed reset |
|----------------|-------|--|-----|---------|------|-----------|-------------------------|
| Fan contactor  | 431   | 1490.25                                | –   | –       | X    | D         | –                       |
| Inrush fault   | 33    | 1490.26                                | X   | X       | X    | D         | X                       |
| Fieldbus fault | 34    | 1490.27                                | X   | D       | –    | –         | –                       |

<sup>1</sup> In small and medium power drives, *alarm 69, Power card temperature* is only a warning.

<sup>2</sup> Only high-power drives.

<sup>3</sup> Warning 59 is configured in 1490.19. The current limit warning can be disabled by choice. The alarm cannot be configured.

VLT® Motion Control Tool MCT 10 has the element numbers listed in the column ID. Use this table with MCT 10 to get information about specific fault levels.

## 5.15 Parameter Group 15-\*\* Drive Information

### 5.15.1 15-0\* Operating Data

#### Parameter 15-00 Operating Hours

Table 761: Parameter 15-00 Operating Hours

| 15-00 Operating Hours |   |                                |
|-----------------------|---|--------------------------------|
| Default value: 0 h    | Parameter type: Range, 0 - 2147483647 h | Setup: All setups              |
| Conversion index: 74  | Data type: Uint32                       | Change during operation: False |

View for how many hours the drive has run. The value is saved when the drive is turned off.

#### Parameter 15-01 Running Hours

Table 762: Parameter 15-01 Running Hours

| 15-01 Running Hours  |   |                                |
|----------------------|---|--------------------------------|
| Default value: 0 h   | Parameter type: Range, 0 - 2147483647 h | Setup: All setups              |
| Conversion index: 74 | Data type: Uint32                       | Change during operation: False |

View how many hours the motor has run. Reset the counter in *parameter 15-07 Reset Running Hours Counter*. The value is saved when the drive is turned off.

#### Parameter 15-02 kWh Counter

Table 763: Parameter 15-02 kWh Counter

| 15-02 kWh Counter    |   |                                |
|----------------------|---|--------------------------------|
| Default value: 0 kWh | Parameter type: Range, 0 - 2147483647 kWh | Setup: All setups              |
| Conversion index: 75 | Data type: Uint32                         | Change during operation: False |

Register the power consumption of the motor as an average value over 1 hour. Reset the counter in *parameter 15-06 Reset kWh Counter*.

## Parameter 15-03 Power Up's

Table 764: Parameter 15-03 Power Up's

| 15-03 Power Up's    |                                       |                                |
|---------------------|---------------------------------------|--------------------------------|
| Default value: 0    | Parameter type: Range, 0 - 2147483647 | Setup: All setups              |
| Conversion index: 0 | Data type: Uint32                     | Change during operation: False |

View the number of times the drive has been powered up.

## Parameter 15-04 Over Temp's

Table 765: Parameter 15-04 Over Temp's

| 15-04 Over Temp's   |                                  |                                |
|---------------------|----------------------------------|--------------------------------|
| Default value: 0    | Parameter type: Range, 0 - 65535 | Setup: All setups              |
| Conversion index: 0 | Data type: Uint16                | Change during operation: False |

View the number of drive temperature faults.

## Parameter 15-05 Over Volt's

Table 766: Parameter 15-05 Over Volt's

| 15-05 Over Volt's   |                                  |                                |
|---------------------|----------------------------------|--------------------------------|
| Default value: 0    | Parameter type: Range, 0 - 65535 | Setup: All setups              |
| Conversion index: 0 | Data type: Uint16                | Change during operation: False |

View the number of drive overvoltages.

## Parameter 15-06 Reset kWh Counter

Table 767: Parameter 15-06 Reset kWh Counter

| 15-06 Reset kWh Counter         |                        |                               |
|---------------------------------|------------------------|-------------------------------|
| Default value: [0] Do not reset | Parameter type: Option | Setup: All setups             |
| Conversion index: -             | Data type: Uint8       | Change during operation: True |

| Option | Name          | Description   |
|--------|---------------|---|
| [0]*   | Do not reset  | No reset of the kWh counter is required.  |
| [1]    | Reset counter | Press [OK] to reset the kWh counter to 0 (see <i>parameter 15-02 kWh Counter</i> ). |

## Parameter 15-07 Reset Running Hours Counter

Table 768: Parameter 15-07 Reset Running Hours Counter

| 15-07 Reset Running Hours Counter |                        |                               |
|-----------------------------------|------------------------|-------------------------------|
| Default value: [0] Do not reset   | Parameter type: Option | Setup: All setups             |
| Conversion index: -               | Data type: Uint8       | Change during operation: True |

| Option | Name          | Description   |
|--------|---------------|---|
| [0]*   | Do not reset  |   |
| [1]    | Reset counter | To reset the running hours counter to 0, select [1] Reset and press [OK] (see <i>parameter 15-01 Running Hours</i> ). This parameter cannot be selected via the serial port, RS485. Select [0] Do not reset if no reset of the running-hours counter is required. |

### 5.15.2 15-1\* Data Log Settings

The data log enables continuous logging of up to 4 data sources (*parameter 15-10 Logging Source*) at individual rates (*parameter 15-11 Logging Interval*). A trigger event (*parameter 15-12 Trigger Event*) and window (*parameter 15-14 Samples Before Trigger*) are used to start and stop the logging conditionally.

#### Parameter 15-10 Logging Source

Table 769: Parameter 15-10 Logging Source

| 15-10 Logging Source    |                                   |                               |
|-------------------------|-----------------------------------|-------------------------------|
| Default value: [0] None | Parameter type: Option, Array [4] | Setup: 2 setups               |
| Conversion index: -     | Data type: Uint16                 | Change during operation: True |

Select the variables to be logged.

| Option | Name                  | Description  |
|--------|-----------------------|--|
| [0]*   | None                  |  |
| [15]   | Readout: Actual setup |  |
| [1397] | Alert alarm word      |  |
| [1398] | Alert warning word    |  |
| [1399] | Alert status word     |  |
| [1472] | Legacy alarm word     |  |
| [1473] | Legacy warning word   |  |
| [1474] | Leg. ext. status word |  |
| [1600] | Control word          |  |
| [1601] | Reference [Unit]      |  |
| [1602] | Reference %           |  |
| [1603] | Status word           |  |
| [1606] | Actual position       |  |
| [1607] | Target position       | This option is only available with software version 48.XX. |
| [1608] | Position error        | This option is only available with software version 48.XX. |
| [1610] | Power [kW]            |  |
| [1611] | Power [hp]            |  |
| [1612] | Motor voltage         |  |
| [1613] | Frequency             |  |
| [1614] | Motor current         |  |

| Option | Name                            | Description  |
|--------|---------------------------------|--|
| [1616] | Torque [Nm]                     |  |
| [1617] | Speed [RPM]                     |  |
| [1618] | Motor thermal                   |  |
| [1620] | Motor angle                     |  |
| [1621] | Torque [%] high res.            |  |
| [1622] | Torque [%]                      |  |
| [1624] | Calibrated stator resistance    |  |
| [1625] | Torque [Nm] high                |  |
| [1628] | Angle error                     | This option is only available with software version 48.XX. |
| [1630] | DC link voltage                 |  |
| [1632] | Brake energy /s                 |  |
| [1633] | Brake energy average            |  |
| [1634] | Heatsink temp.                  |  |
| [1635] | Inverter thermal                |  |
| [1645] | Motor phase U current           |  |
| [1646] | Motor phase V current           |  |
| [1647] | Motor phase W current           |  |
| [1648] | Speed ref. after ramp [RPM]     |  |
| [1650] | External reference              |  |
| [1651] | Pulse reference                 |  |
| [1652] | Feedback[Unit]                  |  |
| [1657] | Feedback [RPM]                  |  |
| [1660] | Digital input                   |  |
| [1662] | Analog input 53                 |  |
| [1664] | Analog input 54                 |  |
| [1665] | Analog output 42 [mA]           |  |
| [1666] | Digital output [bin]            |  |
| [1675] | Analog in X30/11                |  |
| [1676] | Analog in X30/12                |  |
| [1677] | Analog out X30/8 [mA]           |  |
| [1687] | Bus readout alarm/warning       |  |
| [1689] | Configurable alarm/warning word |  |



| Option | Name                      | Description |
|--------|---------------------------|-------------|
| [1690] | Alarm word                |             |
| [1692] | Warning word              |             |
| [1694] | Ext. status word          |             |
| [1695] | Ext. status word 2        |             |
| [1697] | Alarm word 3              |             |
| [1698] | Warning word 3            |             |
| [1820] | Commanded position        |             |
| [1821] | Master position           |             |
| [1823] | Virtual master pos.       |             |
| [1827] | Safe opt. est. speed      |             |
| [1828] | Safe opt. meas. speed     |             |
| [1829] | Safe opt. speed error     |             |
| [1840] | Analog input X49/1        |             |
| [1841] | Analog input X49/3        |             |
| [1842] | Analog input X49/5        |             |
| [1843] | Analog out X49/7          |             |
| [1844] | Analog out X49/9          |             |
| [1845] | Analog out X49/11         |             |
| [1846] | X49 digital output [bin]  |             |
| [1860] | Digital input 2           |             |
| [1899] | Speed PID torque FF. [Nm] |             |
| [3110] | Bypass status word        |             |
| [3466] | SPI error counter         |             |
| [3470] | MCO alarm word 1          |             |
| [3471] | MCO alarm word 2          |             |

### Parameter 15-11 Logging Interval

Table 770: Parameter 15-11 Logging Interval

| 15-11 Logging Interval      |   |                               |
|-----------------------------|---|-------------------------------|
| Default value: Size related | Parameter type: Range, 0.000 - 0.000, Array [4] | Setup: 2 setups               |
| Conversion index: -3        | Data type: Time diff wo DateID [4]              | Change during operation: True |

Enter the interval in ms between each sampling of the variables to be logged.

## Parameter 15-12 Trigger Event

Table 771: Parameter 15-12 Trigger Event

| 15-12 Trigger Event      |                        |                               |
|--------------------------|------------------------|-------------------------------|
| Default value: [0] False | Parameter type: Option | Setup: 1 setup                |
| Conversion index: -      | Data type: Uint8       | Change during operation: True |

Select the trigger event. When the trigger event occurs, a window is applied to freeze the log. The log then retains a specified percentage of samples before the occurrence of the trigger event (*parameter 15-14 Samples Before Trigger*).

| Option | Name                 | Description |
|--------|----------------------|-------------|
| [0]*   | False                |             |
| [1]    | True                 |             |
| [2]    | Running              |             |
| [3]    | In range             |             |
| [4]    | On reference         |             |
| [5]    | Torque limit         |             |
| [6]    | Current limit        |             |
| [7]    | Out of current range |             |
| [8]    | Below I low          |             |
| [9]    | Above I high         |             |
| [10]   | Out of speed range   |             |
| [11]   | Below speed low      |             |
| [12]   | Above speed high     |             |
| [13]   | Out of feedb. range  |             |
| [14]   | Below feedb. low     |             |
| [15]   | Above feedb. high    |             |
| [16]   | Thermal warning      |             |
| [17]   | Mains out of range   |             |
| [18]   | Reversing            |             |
| [19]   | Warning              |             |
| [20]   | Alarm (trip)         |             |
| [21]   | Alarm (trip lock)    |             |
| [22]   | Comparator 0         |             |
| [23]   | Comparator 1         |             |
| [24]   | Comparator 2         |             |
| [25]   | Comparator 3         |             |

| Option | Name               | Description  |
|--------|--------------------|--|
| [26]   | Logic rule 0       |  |
| [27]   | Logic rule 1       |  |
| [28]   | Logic rule 2       |  |
| [29]   | Logic rule 3       |  |
| [33]   | Digital input DI18 |  |
| [34]   | Digital input DI19 |  |
| [35]   | Digital input DI27 |  |
| [36]   | Digital input DI29 | <div style="background-color: #cccccc; padding: 5px; margin-bottom: 5px;"><b>NOTICE</b></div> This option is only available in FC 302. |
| [37]   | Digital input DI32 |  |
| [38]   | Digital input DI33 |  |
| [50]   | Comparator 4       |  |
| [51]   | Comparator 5       |  |
| [60]   | Logic rule 4       |  |
| [61]   | Logic rule 5       |  |

Parameter 15-13 Logging Mode

Table 772: Parameter 15-13 Logging Mode

| 15-13 Logging Mode            |                        |                               |
|-------------------------------|------------------------|-------------------------------|
| Default value: [0] Log always | Parameter type: Option | Setup: 2 setups               |
| Conversion index: -           | Data type: Uint8       | Change during operation: True |

| Option | Name                | Description  |
|--------|---------------------|--|
| [0]*   | Log always          | Select [0] Log always for continuous logging.  |
| [1]    | Log once on trigger | Select [1] Log once on trigger to start and stop logging conditionally using parameter 15-12 Trigger Event and parameter 15-14 Samples Before Trigger. |

Parameter 15-14 Samples Before Trigger

Table 773: Parameter 15-14 Samples Before Trigger

| 15-14 Samples Before Trigger |                                |                               |
|------------------------------|--------------------------------|-------------------------------|
| Default value: 50            | Parameter type: Range, 0 - 100 | Setup: 2 setups               |
| Conversion index: 0          | Data type: Uint8               | Change during operation: True |

Before a trigger event, enter the percentage of all samples which should be retained in the log. See also parameter 15-12 Trigger Event and parameter 15-13 Logging Mode.

## Parameter 15-15 Info Message: "Service Log Full"

Table 774: Parameter 15-15 Info Message: "Service Log Full"

| 15-15 Info Message: "Service Log Full" |                        |                               |
|--|------------------------|-------------------------------|
| Default value: [0] Disabled            | Parameter type: Option | Setup: 1 setup                |
| Conversion index: -                    | Data type: Uint8       | Change during operation: True |

See Service log. By enabling this parameter, a text message is shown in the drive when the service log runs full: *Clear logs, Service log full: 28 [M26]*. The message recommends to clear the log.

| Option | Name     | Description     |
|--------|----------|-----------------|
| [0]*   | Disabled |                 |
| [1]    | Enabled  | Enable message. |

## Parameter 15-17 Service Log Trigger Alarm

Table 775: Parameter 15-17 Service Log Trigger Alarm

| 15-17 Service Log Trigger Alarm |                                  |                               |
|---------------------------------|----------------------------------|-------------------------------|
| Default Value: 0                | Parameter Type: Range, 0 - 9.999 | Setup: 1 setup                |
| Conversion Index: -             | Data Type: Uint8                 | Change during operation: True |

The service log is triggered by a set of factory-defined critical alarms. By using this parameter, an additional alarm to trigger the service log can be defined. The service log registers 11 parameters. 8 parameters are fixed and 3 parameters are user-defined. The 3 user-defined parameters can be configured using the display line parameters *0-20 Display Line 1.1 Small*, *0-21 Display Line 1.2 Small*, and *Display Line 1.3 Small*. All 11 parameters are logged upon a trigger event.

## 5.15.3 Service Log

The service log function saves detailed log information of a 5-second interval when alarms occur. Service technicians can analyze this information to troubleshoot and optimize the drive.

The drive can save up to 24 service log records in the flash memory. To receive a warning when the service log is full, set *parameter 15-15 Info Message: "Service Log Full"* to [1] Enable. To read the current number of records in the memory, check *parameter 16-42 Service Log Counter*.

## Sampling rate

There are 2 periods with different sampling rates:

- Slow samples: 20 samples at a rate of 250 ms resulting in 5 s of history before the trip.
- Fast samples: 50 samples at a rate of 5 ms resulting in 250 ms of detailed history before the trip.

## N O T I C E

To enable the real-time clock (RTC) stamp, use the real-time clock module. If real-time clock is not available, the operating time in *parameter 15-32 Fault Log: Time* is recorded.

Table 776: Logged Channels

| Polling | Color      | Name            |
|---------|------------|-----------------|
| CH 1    | Light gray | Frequency       |
| CH 2    | Dark gray  | Speed [RPM]     |
| CH 3    | Red        | Reference [%]   |
| CH 4    | Orange     | DC-link voltage |
| CH 5    | Yellow     | Motor current   |

| Polling | Color       | Name                 |
|---------|-------------|----------------------|
| CH 6    | Khaki       | Motor voltage        |
| CH 7    | Light green | Control word         |
| CH 8    | Light blue  | Status word          |
| CH 9    | Dark blue   | [20] Operating hours |
| CH 10   | Purple      | [21] Running hours   |
| CH 11   | Magenta     | [22] kWh counter     |

Channels 1–8 are fixed channels with unfiltered signals and cannot be changed. Channels 9–11 are filtered and refer to *parameters 0–20 to 0–22*, which are reflected in the 3 upper lines in the LCP.

#### 5.15.4 Clearing the Service Log

The flash memory stores up to 24 records. To save new logs, clear the service log memory.

Save the service log records using the VLT® Motion Control Tool MCT 10 before clearing the service log.

The service log is stored in EEPROM in the control card and will be erased by initialization, that is when changing the power card. Before changing the power card:

- Click the Service Log icon to read the service log from the drive.
- Copy parameters to a project in MCT 10.
- Save the parameters including the service log in the project.
  - When loading the parameters back into the drive, the service log is not included.

Clear the service log after a commissioning to remove any alarms that occurred during testing.

##### Procedure

1. Select option [5] *Clear Service Log* in *parameter 14-22 Operation Mode*.
2. Power cycle the drive. Clearing the service log extends the power-up time by approximately 1 s.

#### 5.15.5 Service Log Indication

*Parameter 16-42 Service Log Counter* shows the number of service logs stored in the memory.

The drive indicates a full service log memory in 1 of the following ways:

- The LCP shows the message: *Clear logs Service log full: 28 [M26]*.
- Bit 25 is set high in *parameter 16-96 Maintenance Word (0x2000000)*.

Performing the drive initialization does not clear the service log memory.

#### 5.15.6 Reading the Service Log Information

See the VLT® Motion Control Tool MCT 10 to read the service log information.

##### Procedure

1. Open the MCT 10 software.
2. Select a drive.
3. Select the Service Log plug-in.

4. Click *Read from drive*.

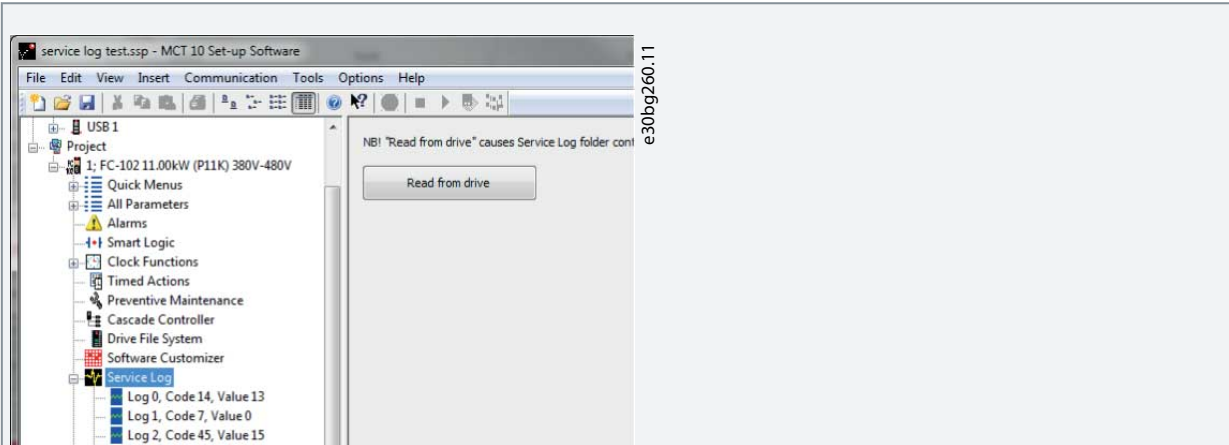

Illustration 90: MCT 10, Read From Drive

The service log view in MCT 10 looks as shown in [Illustration 91](#). Use the cursor to view the detailed readings at a specific time.

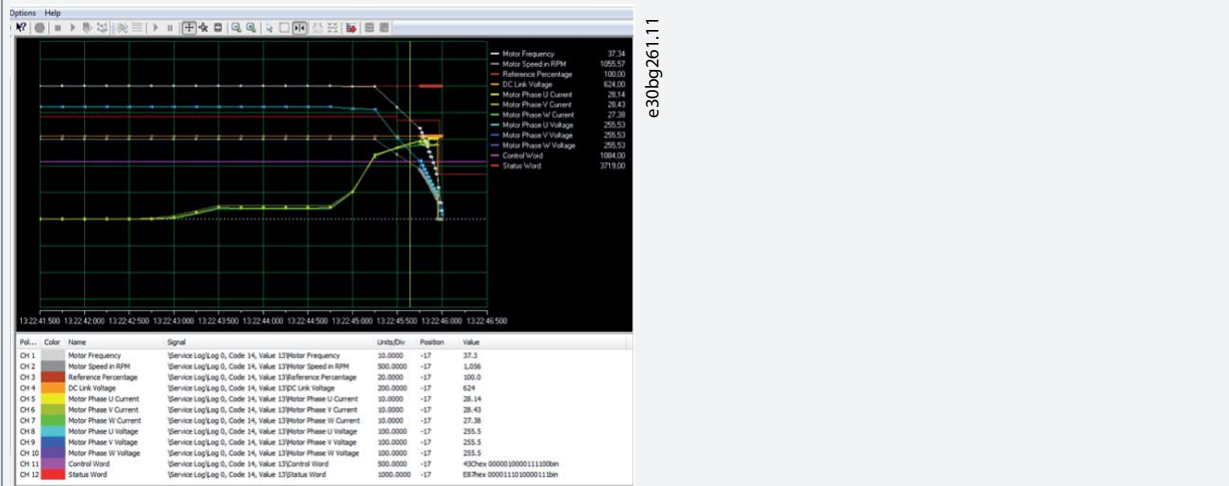

Illustration 91: Service Log View, 5 s

Use the zoom function to focus on the last 250 ms before the fault.

### 5.15.7 Alarms that Trigger a Service Log Record

Table 777: Alarms Triggering a Service Log Record

| #  | Alarm title      |
|----|------------------|
| 4  | Mains phase loss |
| 5  | DC voltage high  |
| 6  | DC voltage low   |
| 7  | DC overvolt      |
| 8  | DC undervolt     |
| 9  | Inverter overld. |
| 10 | Motor ETR over   |
| 12 | Torque limit     |

| #  | Alarm title               |
|----|---------------------------|
| 13 | Over current              |
| 14 | Earth (ground) fault      |
| 16 | Short circuit             |
| 18 | Start failed              |
| 25 | Brake resistor            |
| 26 | Brake overload            |
| 27 | Brake IGBT                |
| 28 | Brake check               |
| 30 | U phase loss              |
| 31 | V phase loss              |
| 32 | W phase loss              |
| 36 | Mains failure             |
| 37 | Phase imbalance           |
| 44 | Earth (ground) fault AL44 |
| 45 | Earth (ground) fault 2    |
| 59 | Current                   |

## N O T I C E

If an alarm has 2 states (warning/alarm), it only triggers a service log record when going into the alarm state.

### 5.15.8 15-2\* Historic Log

View up to 50 logged data items via the array parameters in this parameter group. Data is logged every time an event occurs (not to be confused with SLC events). Events in this context are defined as a change in 1 of the following areas:

- Digital inputs
- Digital outputs
- Warning word
- Alarm word
- Status word
- Control word
- Extended status word

Events are logged with value and time stamp in ms. The time interval between 2 events depends on how often events occur (maximum once every scan time). Data logging is continuous, but if an alarm occurs, the log is saved and the values can be viewed on the display. This feature is useful, for example when carrying out service following a trip. View the historic log contained in this parameter via the serial communication port or via the display.

## Parameter 15-20 Historic Log: Event

Table 778: Parameter 15-20 Historic Log: Event

| 15-20 Historic Log: Event |  |                                |
|---------------------------|--|--------------------------------|
| Default value: 0          | Parameter type: Range, 0 - 255, Array [50] | Setup: All setups              |
| Conversion index: 0       | Data type: Uint8                           | Change during operation: False |

View the event type of the logged events.

## Parameter 15-21 Historic Log: Value

Table 779: Parameter 15-21 Historic Log: Value

| 15-21 Historic Log: Value |   |                                |
|---------------------------|---|--------------------------------|
| Default value: 0          | Parameter type: Range, 0 - 2147483647, Array [50] | Setup: All setups              |
| Conversion index: 0       | Data type: Uint32                                 | Change during operation: False |

View the value of the logged event. Interpret the event values as below:

|   |  |
|---|--|
| Digital input                                     | Decimal value. See <i>parameter 16-60 Digital Input</i> for a description after converting to binary value.        |
| Digital output (not monitored in this SW release) | Decimal value. See <i>parameter 16-66 Digital Output [bin]</i> for a description after converting to binary value. |
| Warning word                                      | Decimal value. See <i>parameter 16-92 Warning Word</i> for a description.  |
| Alarm word  | Decimal value. See <i>parameter 16-90 Alarm Word</i> for a description.  |
| Status word                                       | Decimal value. See <i>parameter 16-03 Status Word</i> for a description after converting to binary value.          |
| Control word                                      | Decimal value. See <i>parameter 16-00 Control Word</i> for a description.  |
| Extended status word                              | Decimal value. See <i>parameter 16-94 Ext. Status Word</i> for a description.                                      |

## Parameter 15-22 Historic Log: Time

Table 780: Parameter 15-22 Historic log: Time

| 15-22 Historic log: Time |  |                                |
|--------------------------|--|--------------------------------|
| Default value: 0 ms      | Parameter type: Range, 0 - 2147483647 ms, Array [50] | Setup: All setups              |
| Conversion index: -3     | Data type: Uint32                                    | Change during operation: False |

View the time at which the logged event occurred. Time is measured in ms since the drive was started. The maximum value corresponds to approximately 24 days, which means that the count restarts at 0 after this period.

## 5.15.9 15-3\* Alarm Log

Parameters in this group are array parameters where up to 10 fault logs can be viewed. 0 is the most recent logged data and 9 is the oldest. Fault codes, values, and time stamp can be viewed for all logged data.

## Parameter 15-30 Fault Log: Error Code

Table 781: Parameter 15-30 Fault Log: Error Code

| 15-30 Fault Log: Error Code |  |                                |
|-----------------------------|--|--------------------------------|
| Default value: 0            | Parameter type: Range, 0 - 65535, Array [10] | Setup: All setups              |
| Conversion index: 0         | Data type: Uint16                            | Change during operation: False |



View the fault code and look up its meaning in [7 Troubleshooting](#).

Parameter 15-31 Fault Log: Value

**Table 782: Parameter 15-31 Fault Log: Value**

| 15-31 Fault Log: Value |   |                                |
|------------------------|---|--------------------------------|
| Default value: 0       | Parameter type: Range, -32767 - 32767, Array [10] | Setup: All setups              |
| Conversion index: 0    | Data type: Uint16                                 | Change during operation: False |

View an extra description of the error. This parameter is mostly used with *alarm 38, internal fault*.

Parameter 15-32 Fault Log: Time

**Table 783: Parameter 15-32 Fault Log: Time**

| 15-32 Fault Log: Time |   |                                |
|-----------------------|---|--------------------------------|
| Default Value: 0 s    | Parameter Type: Range, 0 - 2147483647, Array [10] | Setup: All setups              |
| Conversion Index: 0   | Data Type: Uint32                                 | Change during operation: False |

View the time when the logged event occurred. Time is measured in s from start-up of the drive.

Parameter 15-33 Fault Log: Date and Time

**Table 784: Parameter 15-33 Fault Log: Date and Time**

| 15-33 Fault Log: Date and Time |  |                                |
|--------------------------------|--|--------------------------------|
| Default value: Size related    | Parameter type: Range, 0 - 0, Array [10] | Setup: All setups              |
| Conversion index: 0            | Data type: TimeOfDay                     | Change during operation: False |

Array parameter; Date & Time 0–9: This parameter shows when the logged event occurred.

### 5.15.10 15-4\* Drive Identification

## N O T I C E

The following parameter is only available in FC 302:

- *Parameter 15-58 Smart Setup Filename*

Parameters containing read-only information about the hardware and software configuration of the drive.

Parameter 15-40 FC Type

**Table 785: Parameter 15-40 FC Type**

| 15-40 FC Type       |                              |                                |
|---------------------|------------------------------|--------------------------------|
| Default value: 0    | Parameter type: Range, 0 - 6 | Setup: All setups              |
| Conversion index: 0 | Data type: VisStr[6]         | Change during operation: False |

View the drive type. The readout is identical to the drive power field of the type code definition, characters 1–6.

Parameter 15-41 Power Section

**Table 786: Parameter 15-41 Power Section**

| 15-41 Power Section |                               |                                |
|---------------------|-------------------------------|--------------------------------|
| Default value: 0    | Parameter type: Range, 0 - 20 | Setup: All setups              |
| Conversion index: 0 | Data type: VisStr[20]         | Change during operation: False |

View the power section. The readout is identical to the drive power field of the type code definition, characters 7–10.  
Parameter 15-42 Voltage

Table 787: Parameter 15-42 Voltage

| 15-42 Voltage       |                               |                                |
|---------------------|-------------------------------|--------------------------------|
| Default value: 0    | Parameter type: Range, 0 - 20 | Setup: All setups              |
| Conversion index: 0 | Data type: VisStr[20]         | Change during operation: False |

View the voltage. The readout is identical to the drive power field of the type code definition, characters 11-12.  
Parameter 15-43 Software Version

Table 788: Parameter 15-43 Software Version

| 15-43 Software Version |                              |                                |
|------------------------|------------------------------|--------------------------------|
| Default value: 0       | Parameter type: Range, 0 - 5 | Setup: All setups              |
| Conversion index: 0    | Data type: VisStr[5]         | Change during operation: False |

View the combined SW version (or package version) consisting of power SW and control SW.  
Parameter 15-44 Ordered Typecode String

Table 789: Parameter 15-44 Ordered Typecode String

| 15-44 Ordered Typecode String |                               |                                |
|-------------------------------|-------------------------------|--------------------------------|
| Default value: 0              | Parameter type: Range, 0 - 40 | Setup: All setups              |
| Conversion index: 0           | Data type: VisStr[40]         | Change during operation: False |

View the type code string used for reordering the drive in its original configuration.  
Parameter 15-45 Actual Typecode String

Table 790: Parameter 15-45 Actual Typecode String

| 15-45 Actual Typecode String |                               |                                |
|------------------------------|-------------------------------|--------------------------------|
| Default value: 0             | Parameter type: Range, 0 - 40 | Setup: All setups              |
| Conversion index: 0          | Data type: VisStr[40]         | Change during operation: False |

View the actual type code string.  
Parameter 15-46 Frequency Converter Ordering No

Table 791: Parameter 15-46 Frequency Converter Ordering No

| 15-46 Frequency Converter Ordering No |                              |                                |
|---------------------------------------|------------------------------|--------------------------------|
| Default value: 0                      | Parameter type: Range, 0 - 8 | Setup: All setups              |
| Conversion index: 0                   | Data type: VisStr[8]         | Change during operation: False |

View the 8-digit code number used for reordering the drive in its original configuration. To restore the order number after the power card exchange, see *parameter 14-29 Service Code*.

Parameter 15-47 Power Card Ordering No

Table 792: Parameter 15-47 Power Card Ordering No

| 15-47 Power Card Ordering No |                              |                                |
|------------------------------|------------------------------|--------------------------------|
| Default value: 0             | Parameter type: Range, 0 - 8 | Setup: All setups              |
| Conversion index: 0          | Data type: VisStr[8]         | Change during operation: False |

View the power card code number.  
Parameter 15-48 LCP ID No

**Table 793: Parameter 15-48 LCP ID No**

| 15-48 LCP ID No     |                               |                                |
|---------------------|-------------------------------|--------------------------------|
| Default value: 0    | Parameter type: Range, 0 - 20 | Setup: All setups              |
| Conversion index: 0 | Data type: VisStr[20]         | Change during operation: False |

View the LCP ID number.  
Parameter 15-49 SW ID Control Card

**Table 794: Parameter 15-49 SW ID Control Card**

| 15-49 SW ID Control Card |                               |                                |
|--------------------------|-------------------------------|--------------------------------|
| Default value: 0         | Parameter type: Range, 0 - 20 | Setup: All setups              |
| Conversion index: 0      | Data type: VisStr[20]         | Change during operation: False |

View the control card software version number.  
Parameter 15-50 SW ID Power Card

**Table 795: Parameter 15-50 SW ID Power Card**

| 15-50 SW ID Power Card |                               |                                |
|------------------------|-------------------------------|--------------------------------|
| Default value: 0       | Parameter type: Range, 0 - 20 | Setup: All setups              |
| Conversion index: 0    | Data type: VisStr[20]         | Change during operation: False |

View the power card software version number.  
Parameter 15-51 Frequency Converter Serial Number

**Table 796: Parameter 15-51 Frequency Converter Serial Number**

| 15-51 Frequency Converter Serial Number |                               |                                |
|---|-------------------------------|--------------------------------|
| Default value: 0                        | Parameter type: Range, 0 - 10 | Setup: All setups              |
| Conversion index: 0                     | Data type: VisStr[10]         | Change during operation: False |

View the drive serial number.  
Parameter 15-53 Power Card Serial Number

**Table 797: Parameter 15-53 Power Card Serial Number**

| 15-53 Power Card Serial Number |                               |                                |
|--------------------------------|-------------------------------|--------------------------------|
| Default value: 0               | Parameter type: Range, 0 - 19 | Setup: All setups              |
| Conversion index: 0            | Data type: VisStr[19]         | Change during operation: False |

View the power card serial number.  
Parameter 15-54 Config File Name

**Table 798: Parameter 15-54 Config File Name**

| 15-54 Config File Name      |  |                                |
|-----------------------------|--|--------------------------------|
| Default value: Size related | Parameter type: Range, 0 - 16, Array [8] | Setup: All setups              |
| Conversion index: 0         | Data type: VisStr[16]                    | Change during operation: False |

Shows the special configuration file names.

## Parameter 15-58 Smart Setup Filename

Table 799: Parameter 15-58 Smart Setup Filename

| 15-58 Smart Setup Filename  |                               |                               |
|-----------------------------|-------------------------------|-------------------------------|
| Default value: Size related | Parameter type: Range, 0 - 20 | Setup: All setups             |
| Conversion index: 0         | Data type: VisStr[16]         | Change during operation: True |

Shows the SmartStart file name.

## Parameter 15-59 Filename

Table 800: Parameter 15-59 Filename

| 15-59 Filename              |                               |                                |
|-----------------------------|-------------------------------|--------------------------------|
| Default value: Size related | Parameter type: Range, 0 - 20 | Setup: All setups              |
| Conversion index: 0         | Data type: VisStr[16]         | Change during operation: False |

Shows the currently used customer-specific initial values (CSIV) file name.

## 5.15.11 15-6\* Option Ident.

This read-only parameter group contains information about the hardware and software configuration of the options installed in slots A, B, C0, and C1.

## Parameter 15-60 Option Mounted

Table 801: Parameter 15-60 Option Mounted

| 15-60 Option Mounted |  |                                |
|----------------------|--|--------------------------------|
| Default value: 0     | Parameter type: Range, 0 - 30, Array [8] | Setup: All setups              |
| Conversion index: 0  | Data type: VisStr[30]                    | Change during operation: False |

Shows the type of installed option.

## Parameter 15-61 Option SW Version

Table 802: Parameter 15-61 Option SW Version

| 15-61 Option SW Version |  |                                |
|-------------------------|--|--------------------------------|
| Default value: 0        | Parameter type: Range, 0 - 20, Array [8] | Setup: All setups              |
| Conversion index: 0     | Data type: VisStr[20]                    | Change during operation: False |

View the installed option software version.

## Parameter 15-62 Option Ordering No

Table 803: Parameter 15-62 Option Ordering No

| 15-62 Option Ordering No |   |                                |
|--------------------------|---|--------------------------------|
| Default value: 0         | Parameter type: Range, 0 - 8, Array [8] | Setup: All setups              |
| Conversion index: 0      | Data type: VisStr[8]                    | Change during operation: False |

Shows the code number for the installed options.

Parameter 15-63 Option Serial No

**Table 804: Parameter 15-63 Option Serial No**

| 15-63 Option Serial No |  |                                |
|------------------------|--|--------------------------------|
| Default value: 0       | Parameter type: Range, 0 - 18, Array [8] | Setup: All setups              |
| Conversion index: 0    | Data type: VisStr[18]                    | Change during operation: False |

View the installed option serial number.

Parameter 15-70 Option in Slot A

**Table 805: Parameter 15-70 Option in Slot A**

| 15-70 Option in Slot A |                               |                                |
|------------------------|-------------------------------|--------------------------------|
| Default value: 0       | Parameter type: Range, 0 - 30 | Setup: All setups              |
| Conversion index: 0    | Data type: VisStr[30]         | Change during operation: False |

View the type code string for the option installed in slot A and a translation of the type code string. For example, for type code string *AX*, the translation is *No option*.

Parameter 15-71 Slot A Option SW Version

**Table 806: Parameter 15-71 Slot A Option SW Version**

| 15-71 Slot A Option SW Version |                               |                                |
|--------------------------------|-------------------------------|--------------------------------|
| Default value: 0               | Parameter type: Range, 0 - 20 | Setup: All setups              |
| Conversion index: 0            | Data type: VisStr[20]         | Change during operation: False |

View the software version for the option installed in slot A.

Parameter 15-72 Option in Slot B

**Table 807: Parameter 15-72 Option in Slot B**

| 15-72 Option in Slot B |                               |                                |
|------------------------|-------------------------------|--------------------------------|
| Default value: 0       | Parameter type: Range, 0 - 30 | Setup: All setups              |
| Conversion index: 0    | Data type: VisStr[30]         | Change during operation: False |

View the type code string for the option installed in slot B and a translation of the type code string. For example, for type code string *BX*, the translation is *No option*.

Parameter 15-73 Slot B SW Version

**Table 808: Parameter 15-73 Slot B SW Version**

| 15-73 Slot B SW Version |                               |                                |
|-------------------------|-------------------------------|--------------------------------|
| Default value: 0        | Parameter type: Range, 0 - 20 | Setup: All setups              |
| Conversion index: 0     | Data type: VisStr[20]         | Change during operation: False |

View the software version for the option installed in slot B.

Parameter 15-74 Option in Slot C0/E0

**Table 809: Parameter 15-74 Option in Slot C0/E0**

| 15-74 Option in Slot C0/E0 |                               |                                |
|----------------------------|-------------------------------|--------------------------------|
| Default value: 0           | Parameter type: Range, 0 - 30 | Setup: All setups              |
| Conversion index: 0        | Data type: VisStr[30]         | Change during operation: False |

View the type code string for the option installed in slot C and a translation of the type code string. For example, for type code string CXXX, the translation is *No option*.

Parameter 15-75 Slot C0/E0 Option SW Version

Table 810: Parameter 15-75 Slot C0/E0 Option SW Version

| 15-75 Slot C0/E0 Option SW Version |                               |                                |
|------------------------------------|-------------------------------|--------------------------------|
| Default value: 0                   | Parameter type: Range, 0 - 20 | Setup: All setups              |
| Conversion index: 0                | Data type: VisStr[20]         | Change during operation: False |

View the software version for the option installed in slot C.

Parameter 15-76 Option in Slot C1/E1

Table 811: Parameter 15-76 Option in Slot C1/E1

| 15-76 Option in Slot C1/E1 |                               |                                |
|----------------------------|-------------------------------|--------------------------------|
| Default value: 0           | Parameter type: Range, 0 - 30 | Setup: All setups              |
| Conversion index: 0        | Data type: VisStr[30]         | Change during operation: False |

View the type code string for the option installed in slot C1 and a translation of the type code string. For example, for type code string CXXX, the translation is *No option*.

Parameter 15-77 Slot C1/E1 Option SW Version

Table 812: Parameter 15-77 Slot C1/E1 Option SW Version

| 15-77 Slot C1/E1 Option SW Version |                               |                                |
|------------------------------------|-------------------------------|--------------------------------|
| Default value: 0                   | Parameter type: Range, 0 - 20 | Setup: All setups              |
| Conversion index: 0                | Data type: VisStr[20]         | Change during operation: False |

Shows the software version for the installed option in option slot C.

### 5.15.12 15-8\* Operating Data II

Parameter 15-80 Fan Running Hours

Table 813: Parameter 15-80 Fan Running Hours

| 15-80 Fan Running Hours |   |                               |
|-------------------------|---|-------------------------------|
| Default value: 0 h      | Parameter type: Range, 0 - 2147483647 h | Setup: All setups             |
| Conversion index: 74    | Data type: Uint32                       | Change during operation: True |

View for how many hours the heat sink fan has run (increments for every hour). The value is saved when the drive is turned off.

Parameter 15-81 Preset Fan Running Hours

Table 814: Parameter 15-81 Preset Fan Running Hours

| 15-81 Preset Fan Running Hours |                                    |                               |
|--------------------------------|------------------------------------|-------------------------------|
| Default value: 0 h             | Parameter type: Range, 0 - 99999 h | Setup: All setups             |
| Conversion index: 74           | Data type: Uint32                  | Change during operation: True |

Enter the preset fan running hours counter, see *parameter 15-80 Fan Running Hours*. This parameter cannot be selected via the serial port RS485.

## Parameter 15-87 kWh Counter Hires

Table 815: Parameter 15-87 kWh Counter Hires

| 15-87 kWh Counter Hires |   |                                |
|-------------------------|---|--------------------------------|
| Default value: 0 kWh    | Parameter type: Range, 0 - 2147483647 kWh | Setup: All setups              |
| Conversion index: 75    | Data type: Uint32                         | Change during operation: False |

Register the power consumption of the motor as an average value over 1 hour. Reset the counter in *parameter 15-06 Reset kWh Counter*. The decimal places are reset at power-up.

## Parameter 15-89 Configuration Change Counter

Table 816: Parameter 15-89 Configuration Change Counter

| 15-89 Configuration Change Counter |                                  |                                |
|------------------------------------|----------------------------------|--------------------------------|
| Default value: 0                   | Parameter type: Range, 0 - 65535 | Setup: All setups              |
| Conversion index: 0                | Data type: Uint16                | Change during operation: False |

## NOTICE

This parameter cannot be adjusted while the motor is running.

### 5.15.13 15-9\* Parameter Info

## Parameter 15-92 Defined Parameters

Table 817: Parameter 15-92 Defined Parameters

| 15-92 Defined Parameters |   |                                |
|--------------------------|---|--------------------------------|
| Default value: 0         | Parameter type: Range, 0 - 9999, Array [1000] | Setup: All setups              |
| Conversion index: 0      | Data type: Uint16                             | Change during operation: False |

View a list of all defined parameters in the drive. The list ends with 0.

## Parameter 15-93 Modified Parameters

Table 818: Parameter 15-93 Modified Parameters

| 15-93 Modified Parameters |   |                                |
|---------------------------|---|--------------------------------|
| Default value: 0          | Parameter type: Range, 0 - 9999, Array [1000] | Setup: All setups              |
| Conversion index: 0       | Data type: Uint16                             | Change during operation: False |

View a list of the parameters that have been changed from their default setting. The list ends with 0. Changes may not be visible until up to 30 s after implementation.

## Parameter 15-94 Extended Version

Table 819: Parameter 15-94 Extended Version

| 15-94 Extended Version      |   |                               |
|-----------------------------|---|-------------------------------|
| Default value: Size related | Parameter type: Range, 0 - 65, Array [10] | Setup: All setups             |
| Conversion index: 0         | Data type: VisibleString                  | Change during operation: True |

INPUT MISSING

## Parameter 15-98 Drive Identification

Table 820: Parameter 15-98 Drive Identification

| 15-98 Drive Identification |                               |                                |
|----------------------------|-------------------------------|--------------------------------|
| Default value: 0           | Parameter type: Range, 0 - 40 | Setup: All setups              |
| Conversion index: 0        | Data type: VisStr[40]         | Change during operation: False |

This parameter contains data used by the VLT® Motion Control Tool MCT 10.

## Parameter 15-99 Parameter Metadata

Table 821: Parameter 15-99 Parameter Metadata

| 15-99 Parameter Metadata |   |                                |
|--------------------------|---|--------------------------------|
| Default value: 0         | Parameter type: Range, 0 - 9999, Array [35] | Setup: All setups              |
| Conversion index: 0      | Data type: Uint16                           | Change during operation: False |

This parameter contains data used by the VLT® Motion Control Tool MCT 10.

## 5.16 Parameter Group 16-\*\* Data Readouts

## 5.16.1 16-0\* General Status

## Parameter 16-00 Control Word

Table 822: Parameter 16-00 Control Word

| 16-00 Control Word  |                                  |                                |
|---------------------|----------------------------------|--------------------------------|
| Default Value: 0    | Parameter Type: Range, 0 - 65535 | Setup: All setups              |
| Conversion Index: 0 | Data Type: V2                    | Change during operation: False |

View the control word sent to the drive via the serial communication port in hex code.

## Parameter 16-01 Reference [Unit]

Table 823: Parameter 16-01 Reference [Unit]

| 16-01 Reference [Unit]                 |   |                                |
|--|---|--------------------------------|
| Default value: 0 ReferenceFeedbackUnit | Parameter type: Range, -999999 ReferenceFeedbackUnit - 999999 ReferenceFeedbackUnit | Setup: All setups              |
| Conversion index: -3                   | Data type: Int32  | Change during operation: False |

View the present reference value applied on impulse or analog basis in the unit resulting from the configuration selected in *parameter 1-00 Configuration Mode* (Hz, Nm, or RPM).

## Parameter 16-02 Reference %

Table 824: Parameter 16-02 Reference %

| 16-02 Reference %    |                                    |                                |
|----------------------|------------------------------------|--------------------------------|
| Default value: 0%    | Parameter type: Range, -200 - 200% | Setup: All setups              |
| Conversion index: -1 | Data type: Int16                   | Change during operation: False |

View the total reference. The total reference is the sum of digital, analog, preset, bus, and freeze references plus catch up and slow down.



## Parameter 16-03 Status Word

Table 825: Parameter 16-03 Status Word

| 16-03 Status Word   |                                  |                                |
|---------------------|----------------------------------|--------------------------------|
| Default value: 0    | Parameter type: Range, 0 - 65535 | Setup: All setups              |
| Conversion index: 0 | Data type: V2                    | Change during operation: False |

View the status word sent from the drive via the serial communication port in hex code.

## Parameter 16-05 Main Actual Value [%]

Table 826: Parameter 16-05 Main Actual Value [%]

| 16-05 Main Actual Value [%] |                                    |                                |
|-----------------------------|------------------------------------|--------------------------------|
| Default value: 0%           | Parameter type: Range, -100 - 100% | Setup: All setups              |
| Conversion index: -2        | Data type: N2                      | Change during operation: False |

View the 2-byte word sent with the status word to the fieldbus master reporting the main actual value.

## Parameter 16-06 Actual Position

Table 827: Parameter 16-06 Actual Position

| 16-06 Actual Position               |   |                                |
|-------------------------------------|---|--------------------------------|
| Default value: 0 CustomReadoutUnit2 | Parameter type: Range, -2000000000 CustomReadoutUnit2 - 2000000000 CustomReadoutUnit2 | Setup: All setups              |
| Conversion index: 0                 | Data type: Int32  | Change during operation: False |

Shows the actual position in position units defined in *parameter group 17-7\* Position Scaling*. The value is based on the encoder feedback in closed loop or on the angle calculated by the motor control in open loop. For information about configuring the readouts, see *parameter group 17-7\* Position Scaling*.

## Parameter 16-07 Target Position

Table 828: Parameter 16-07 Target Position

| 16-07 Target Position               |   |                                |
|-------------------------------------|---|--------------------------------|
| Default value: 0 CustomReadoutUnit2 | Parameter type: Range, -2000000000 CustomReadoutUnit2 - 2000000000 CustomReadoutUnit2 | Setup: All setups              |
| Conversion index: 0                 | Data type: Int32  | Change during operation: False |

## N O T I C E

This parameter is only valid with software version 48.XX.

Shows the actual end target position for the active positioning command in position units. Position units are defined in *parameter group 17-7\* Position Scaling*.

## Parameter 16-08 Position Error

Table 829: Parameter 16-08 Position Error

| 16-08 Position Error                |   |                                |
|-------------------------------------|---|--------------------------------|
| Default value: 0 CustomReadoutUnit2 | Parameter type: Range, -2000000000 CustomReadoutUnit2 - 2000000000 CustomReadoutUnit2 | Setup: All setups              |
| Conversion index: 0                 | Data type: Int32  | Change during operation: False |

## N O T I C E

This parameter is only valid with software version 48.XX.

Shows the actual position error in position units defined in *parameter group 17-7\* Position Scaling*. Position error is the difference between the actual position and the commanded position. The position error is the input for the position PI controller.

Parameter 16-09 Customer Readout

**Table 830: Parameter 16-09 Customer Readout**

| 16-09 Customer Readout             |  |                                |
|------------------------------------|--|--------------------------------|
| Default value: 0 CustomReadoutUnit | Parameter type: Range, 0 CustomReadoutUnit - 999999.99 CustomReadoutUnit | Setup: All setups              |
| Conversion index: -2               | Data type: Int32   | Change during operation: False |

View the value of custom readout from *parameter 0-30 Unit for Userdefined Readout* to *parameter 0-32 Custom Readout Max Value*.

### 5.16.2 16-1\* Motor Status

## N O T I C E

The following parameter is only available in FC 302:

- *Parameter 16-24 Calibrated Stator Resistance*

Parameter 16-10 Power [kW]

**Table 831: Parameter 16-10 Power [kW]**

| 16-10 Power [kW]    |                                     |                                |
|---------------------|-------------------------------------|--------------------------------|
| Default value: 0 kW | Parameter type: Range, 0 - 10000 kW | Setup: All setups              |
| Conversion index: 1 | Data type: Int32                    | Change during operation: False |

Shows motor power in kW. The value shown is calculated based on the actual motor voltage and motor current. The value is filtered, and therefore approximately 1.3 s may pass from when an input value changes to when the data readout values change. The resolution of readout value on fieldbus is in 10-W steps. The base unit is in W.

Parameter 16-11 Power [hp]

**Table 832: Parameter 16-11 Power [hp]**

| 16-11 Power [hp]     |                                     |                                |
|----------------------|-------------------------------------|--------------------------------|
| Default value: 0 hp  | Parameter type: Range, 0 - 10000 hp | Setup: All setups              |
| Conversion index: -2 | Data type: Int32                    | Change during operation: False |

Shows motor power in hp. The value shown is calculated based on the actual motor voltage and motor current. The value is filtered, and therefore approximately 1.3 ms may pass from when an input value changes to when the data readout values change.

Parameter 16-12 Motor Voltage

**Table 833: Parameter 16-12 Motor Voltage**

| 16-12 Motor Voltage  |                                   |                                |
|----------------------|-----------------------------------|--------------------------------|
| Default value: 0 V   | Parameter type: Range, 0 - 6000 V | Setup: All setups              |
| Conversion index: -1 | Data type: Uint16                 | Change during operation: False |

View the motor voltage, a calculated value used for controlling the motor.

## Parameter 16-13 Frequency

Table 834: Parameter 16-13 Frequency

| 16-13 Frequency      |                                    |                                |
|----------------------|------------------------------------|--------------------------------|
| Default value: 0 Hz  | Parameter type: Range, 0 - 6500 Hz | Setup: All setups              |
| Conversion index: -1 | Data type: Uint16                  | Change during operation: False |

View the motor frequency without resonance damping.

## Parameter 16-14 Motor Current

Table 835: Parameter 16-14 Motor Current

| 16-14 Motor Current  |                                    |                                |
|----------------------|------------------------------------|--------------------------------|
| Default value: 0 A   | Parameter type: Range, 0 - 10000 A | Setup: All setups              |
| Conversion index: -2 | Data type: Int32                   | Change during operation: False |

View the motor current measured as an average value,  $I_{RMS}$ . The value is filtered, and thus approximately 1.3 s may pass from when an input value changes to when the data readout values change.

## Parameter 16-15 Frequency [%]

Table 836: Parameter 16-15 Frequency [%]

| 16-15 Frequency [%]  |                                    |                                |
|----------------------|------------------------------------|--------------------------------|
| Default value: 0%    | Parameter type: Range, -100 - 100% | Setup: All setups              |
| Conversion index: -2 | Data type: N2                      | Change during operation: False |

View a 2-byte word reporting the actual motor frequency (without resonance damping) as a percentage (scale 0000–4000 hex) of *parameter 4-19 Max Output Frequency*. Set *parameter 9-16 PCD Read Configuration* index 1 to send it with the status word instead of the MAV.

## Parameter 16-16 Torque [Nm]

Table 837: Parameter 16-16 Torque [Nm]

| 16-16 Torque [Nm]    |  |                                |
|----------------------|--|--------------------------------|
| Default value: 0 Nm  | Parameter type: Range, -3000 - 3000 Nm | Setup: All setups              |
| Conversion index: -1 | Data type: Int16                       | Change during operation: False |

View the torque value with sign, applied to the motor shaft. Linearity is not exact between 160% motor current and torque in relation to the rated torque. Some motors supply more than 160% torque. Therefore, the minimum value and the maximum value depend on the maximum motor current and the motor used. The value is filtered, and thus approximately 30 ms may pass from when an input changes value to when the data readout values change. In flux control principle, this readout is compensated for in *parameter 1-68 Motor Inertia* for improved accuracy.

## Parameter 16-17 Speed [RPM]

Table 838: Parameter 16-17 Speed [RPM]

| 16-17 Speed [RPM]    |  |                                |
|----------------------|--|--------------------------------|
| Default value: 0 RPM | Parameter type: Range, -30000 - 30000 Nm | Setup: All setups              |
| Conversion index: 67 | Data type: Int32                         | Change during operation: False |

View the actual motor RPM. In open-loop or closed-loop process control, the motor RPM is estimated. In speed closed-loop modes, the motor RPM is measured.

## Parameter 16-18 Motor Thermal

Table 839: Parameter 16-18 Motor Thermal

| 16-18 Motor Thermal |                                 |                                |
|---------------------|---------------------------------|--------------------------------|
| Default value: 0%   | Parameter type: Range, 0 - 100% | Setup: All setups              |
| Conversion index: 0 | Data type: Uint8                | Change during operation: False |

View the calculated thermal load on the motor. The cutout limit is 100%. The basis for calculation is the ETR function selected in *parameter 1-90 Motor Thermal Protection*.

## Parameter 16-19 Thermistor Sensor Temperature

Table 840: Parameter 16-19 Thermistor Sensor Temperature

| 16-19 Thermistor Sensor Temperature |                                 |                                |
|-------------------------------------|---------------------------------|--------------------------------|
| Default value: 0 °C                 | Parameter type: Range, 0 - 0 °C | Setup: All setups              |
| Conversion index: 100               | Data type: Int16                | Change during operation: False |

Returning the actual temperature on KTY sensor built into the motor. See *parameter group 1-9\* Motor Temperature*.

## Parameter 16-20 Motor Angle

Table 841: Parameter 16-20 Motor Angle

| 16-20 Motor Angle   |                                  |                               |
|---------------------|----------------------------------|-------------------------------|
| Default value: 0    | Parameter type: Range, 0 - 65535 | Setup: All setups             |
| Conversion index: 0 | Data type: Uint16                | Change during operation: True |

View the current encoder/resolver angle offset relative to the index position. The value range of 0–65535 corresponds to 0–2 $\pi$  (radian).

## Parameter 16-21 Torque [%] High Res.

Table 842: Parameter 16-21 Torque [%] High Res.

| 16-21 Torque [%] High Res. |                                    |                                |
|----------------------------|------------------------------------|--------------------------------|
| Default value: 0%          | Parameter type: Range, -200 - 200% | Setup: All setups              |
| Conversion index: -1       | Data type: Int16                   | Change during operation: False |

The value shown is the torque in percent of nominal torque, with sign and 0.1% resolution, applied to the motor shaft.

## Parameter 16-22 Torque [%]

Table 843: Parameter 16-22 Torque [%]

| 16-22 Torque [%]    |                                    |                                |
|---------------------|------------------------------------|--------------------------------|
| Default value: 0%   | Parameter type: Range, -200 - 200% | Setup: All setups              |
| Conversion index: 1 | Data type: Int16                   | Change during operation: False |

The value shown is the torque in percent of nominal torque, with sign, applied to the motor shaft.

## Parameter 16-23 Motor Shaft Power [kW]

Table 844: Parameter 16-23 Motor Shaft Power [kW]

| 16-23 Motor Shaft Power [kW] |                                     |                               |
|------------------------------|-------------------------------------|-------------------------------|
| Default value: 0 kW          | Parameter type: Range, 0 - 10000 kW | Setup: All setups             |
| Conversion index: -1         | Data type: Int32                    | Change during operation: True |

Readout of the mechanical power applied to the motor shaft. The base unit is in W.  
Parameter 16-24 Calibrated Stator Resistance

Table 845: Parameter 16-24 Calibrated Stator Resistance

| 16-24 Calibrated Stator Resistance |  |                               |
|------------------------------------|--|-------------------------------|
| Default value: 0.0000 Ohm          | Parameter type: Range, 0.0000 - 100.0000 Ohm | Setup: All setups             |
| Conversion index: -4               | Data type: Uint32                            | Change during operation: True |

Shows the calibrated stator resistance.  
Parameter 16-25 Torque [Nm] High

Table 846: Parameter 16-25 Torque [Nm] High

| 16-25 Torque [Nm] High |  |                                |
|------------------------|--|--------------------------------|
| Default value: 0 Nm    | Parameter type: Range, -200000000 - 200000000 Nm | Setup: All setups              |
| Conversion index: -1   | Data type: Int32                                 | Change during operation: False |

View the torque value with sign, applied to the motor shaft. Some motors supply more than 160% torque. Therefore, the minimum value and the maximum value depend on the maximum motor current as well as the motor used. This specific readout has been adapted to be able to show higher values than the standard readout in *parameter 16-16 Torque [Nm]*.

Parameter 16-28 Angle Error

Table 847: Parameter 16-28 Angle Error

| 16-28 Angle Error    |                                     |                                |
|----------------------|-------------------------------------|--------------------------------|
| Default value: 0 °   | Parameter type: Range, -180 - 180 ° | Setup: All setups              |
| Conversion index: -2 | Data type: Int16                    | Change during operation: False |

Readout of the deviation between sensorless rotor angle estimation by motor controller and real rotor angle based on encoder reading. The parameter is only activated if options in *parameter 1-01 Motor Control Principle* is set to [2] Flux Sensorless and *parameter 1-10 Motor Construction* is set to [1] PM, non salient SPM or [2] PM, salient IPM. The encoder source used for comparison must be selected in *parameter 7-00 Speed PID Feedback Source*. To obtain an accurate reading of *parameter 16-28 Angle Error*, the motor angle offset must be set in *parameter 1-41 Motor Angle Offset*. Rotor detection is configured in *parameter 7-90 Position PI Feedback Source*, which is activated using the setting in *parameter 1-70 Start Mode* in Flux with motor feedback. *Parameter 7-90 Position PI Feedback Source* must be set to [0] Motor feedb.P1-02. The encoder is then only used for comparison while position control is based on the estimated sensorless position. This enables the measurement of the accuracy of position control in sensorless mode.

### 5.16.3 16-3\* Drive Status

#### NOTICE

The following parameters are only available in FC 302:

- *Parameter 16-31 System Temp.*
- *Parameter 16-49 Current Fault Source*

Parameter 16-30 DC Link Voltage

Table 848: Parameter 16-30 DC Link Voltage

| 16-30 DC Link Voltage |                                    |                                |
|-----------------------|------------------------------------|--------------------------------|
| Default value: 0 V    | Parameter type: Range, 0 - 10000 V | Setup: All setups              |
| Conversion index: 0   | Data type: Uint16                  | Change during operation: False |

View a measured value. The value is filtered with a 30 ms time constant.

Parameter 16-31 System Temp.

Table 849: Parameter 16-31 System Temp.

| 16-31 System Temp.    |                                      |                               |
|-----------------------|--------------------------------------|-------------------------------|
| Default value: 0 °C   | Parameter type: Range, -128 - 127 °C | Setup: All setups             |
| Conversion index: 100 | Data type: Int8                      | Change during operation: True |

Shows the highest internal system temperature. In the smaller enclosure sizes (A–C), the system temperature matches the control card temperature measurement in *parameter 16-39 Control Card Temp*. In the larger enclosure sizes (D–F), the system temperature is the highest temperature measured on hardware components with temperature sensors, for example, the power card(s).

Parameter 16-32 Brake Energy /s

Table 850: Parameter 16-32 Brake Energy /s

| 16-32 Brake Energy /s |                                     |                                |
|-----------------------|-------------------------------------|--------------------------------|
| Default value: 0 kW   | Parameter type: Range, 0 - 10000 kW | Setup: All setups              |
| Conversion index: 0   | Data type: Uint32                   | Change during operation: False |

View the brake power transmitted to an external brake resistor, stated as an instant value.

Parameter 16-33 Brake Energy Average

Table 851: Parameter 16-33 Brake Energy Average

| 16-33 Brake Energy Average |                                     |                                |
|----------------------------|-------------------------------------|--------------------------------|
| Default value: 0 kW        | Parameter type: Range, 0 - 10000 kW | Setup: All setups              |
| Conversion index: 0        | Data type: Uint32                   | Change during operation: False |

View the brake power transmitted to an external brake resistor. The mean power is calculated on an average level based on the selected time period within *parameter 2-13 Brake Power Monitoring*.

Parameter 16-34 Heatsink Temp.

Table 852: Parameter 16-34 Heatsink Temp.

| 16-34 Heatsink Temp.  |                                   |                                |
|-----------------------|-----------------------------------|--------------------------------|
| Default value: 0 °C   | Parameter type: Range, 0 - 255 °C | Setup: All setups              |
| Conversion index: 100 | Data type: Uint8                  | Change during operation: False |

View the drive heat sink temperature. The cutout limit is  $90 \pm 5$  °C ( $194 \pm 9$  °F), and the motor cuts back in at  $60 \pm 5$  °C ( $140 \pm 9$  °F).

Parameter 16-35 Inverter Thermal

Table 853: Parameter 16-35 Inverter Thermal

| 16-35 Inverter Thermal |                                 |                                |
|------------------------|---------------------------------|--------------------------------|
| Default value: 0%      | Parameter type: Range, 0 - 100% | Setup: All setups              |
| Conversion index: 0    | Data type: Uint8                | Change during operation: False |

View the percentage load on the inverter.

## Parameter 16-36 Inv. Nom. Current

Table 854: Parameter 16-36 Inv. Nom. Current

| 16-36 Inv. Nom. Current     |                                       |                                |
|-----------------------------|---------------------------------------|--------------------------------|
| Default value: Size related | Parameter type: Range, 0.01 - 10000 A | Setup: All setups              |
| Conversion index: -2        | Data type: Uint32                     | Change during operation: False |

View the inverter nominal current, which must match the nameplate data on the connected motor. The data is used for calculation of torque, motor overload protection, and so on.

## Parameter 16-37 Inv. Max. Current

Table 855: Parameter 16-37 Inv. Max. Current

| 16-37 Inv. Max. Current     |                                       |                                |
|-----------------------------|---------------------------------------|--------------------------------|
| Default value: Size related | Parameter type: Range, 0.01 - 10000 A | Setup: All setups              |
| Conversion index: -2        | Data type: Uint32                     | Change during operation: False |

View the inverter maximum current, which must match the nameplate data on the connected motor. The data is used for calculation of torque, motor overload protection, and so on.

## Parameter 16-38 SL Controller State

Table 856: Parameter 16-38 SL Controller State

| 16-38 SL Controller State |   |                                |
|---------------------------|---|--------------------------------|
| Default value: 0          | Parameter type: Range, 0 - 100, Array [4] | Setup: All setups              |
| Conversion index: 0       | Data type: Uint8                          | Change during operation: False |

View the state of the event under execution by the SL controller.

## Parameter 16-39 Control Card Temp.

Table 857: Parameter 16-39 Control Card Temp.

| 16-39 Control Card Temp. |                                   |                                |
|--------------------------|-----------------------------------|--------------------------------|
| Default value: 0 °C      | Parameter type: Range, 0 - 100 °C | Setup: All setups              |
| Conversion index: 100    | Data type: Uint8                  | Change during operation: False |

View the temperature on the control card, stated in °C.

## Parameter 16-40 Logging Buffer Full

Table 858: Parameter 16-40 Logging Buffer Full

| 16-40 Logging Buffer Full |                        |                               |
|---------------------------|------------------------|-------------------------------|
| Default value: [0] No     | Parameter type: Option | Setup: All setups             |
| Conversion index: -       | Data type: Uint8       | Change during operation: True |

View whether the logging buffer is full (see *parameter group 15-1\* Data Log Settings*). The logging buffer is never full when *parameter 15-13 Logging Mode* is set to [0] Log always.

| Option | Name | Description |
|--------|------|-------------|
| [0]*   | No   |             |
| [1]    | Yes  |             |

## Parameter 16-41 Performance Maintenance

Table 859: Parameter 16-41 Performance Maintenance

| 16-41 Performance Maintenance |                                       |                               |
|-------------------------------|---------------------------------------|-------------------------------|
| Default value: 0              | Parameter type: Range, 0 - 2147483647 | Setup: All setups             |
| Conversion index: 0           | Data type: VisStr[50]                 | Change during operation: True |

## Parameter 16-42 Service Log Counter

Table 860: Parameter 16-42 Service Log Counter

| 16-42 Service Log Counter |                               |                               |
|---------------------------|-------------------------------|-------------------------------|
| Default value: 0          | Parameter type: Range, 0 - 24 | Setup: All setups             |
| Conversion index: 0       | Data type: Uint8              | Change during operation: True |

Shows the number of service logs stored in the ServiceLog file. If the ServiceLog file is full, clear the logged data by selecting option [5] *Clear service logs in parameter 14-22 Operation Mode*. The logged data is deleted on the next power-up.

## Parameter 16-43 Timed Actions Status

Table 861: Parameter 16-43 Timed Actions Status

| 16-43 Timed Actions Status            |                        |                               |
|---------------------------------------|------------------------|-------------------------------|
| Default value: [0] Timed actions auto | Parameter type: Option | Setup: All setups             |
| Conversion index: -                   | Data type: Uint8       | Change during operation: True |

Select the times actions view.

| Option | Name                   | Description |
|--------|------------------------|-------------|
| [0]*   | Timed actions auto     |             |
| [1]    | Timed actions disabled |             |
| [2]    | Constant on action     |             |
| [3]    | Constant off actions   |             |

## Parameter 16-44 Speed Error [RPM]

Table 862: Parameter 16-44 Speed Error [RPM]

| 16-44 Speed Error [RPM] |   |                               |
|-------------------------|---|-------------------------------|
| Default value: 0 RPM    | Parameter type: Range, -30000 - 30000 RPM | Setup: All setups             |
| Conversion index: 67    | Data type: Int32                          | Change during operation: True |

## N O T I C E

This parameter is only available with software version 48.XX.

Shows the difference between the speed reference and the actual speed.



## Parameter 16-45 Motor Phase U Current

Table 863: Parameter 16-45 Motor Phase U Current

| 16-45 Motor Phase U Current |                                    |                               |
|-----------------------------|------------------------------------|-------------------------------|
| Default value: 0 A          | Parameter type: Range, 0 - 10000 A | Setup: All setups             |
| Conversion index: -2        | Data type: Int32                   | Change during operation: True |

Shows the motor phase  $U_{RMS}$  current. Facilitates monitoring of imbalance in the motor currents, detection of weak motor cables or imbalance in motor windings.

## Parameter 16-46 Motor Phase V Current

Table 864: Parameter 16-46 Motor Phase V Current

| 16-46 Motor Phase V Current |                                    |                               |
|-----------------------------|------------------------------------|-------------------------------|
| Default value: 0 A          | Parameter type: Range, 0 - 10000 A | Setup: All setups             |
| Conversion index: -2        | Data type: Int32                   | Change during operation: True |

Shows the motor phase  $V_{RMS}$  current. Facilitates monitoring of imbalance in the motor currents, detection of weak motor cables or imbalance in motor windings.

## Parameter 16-47 Motor Phase W Current

Table 865: Parameter 16-47 Motor Phase W Current

| 16-47 Motor Phase W Current |                                    |                               |
|-----------------------------|------------------------------------|-------------------------------|
| Default value: 0 A          | Parameter type: Range, 0 - 10000 A | Setup: All setups             |
| Conversion index: -2        | Data type: Int32                   | Change during operation: True |

Shows the motor phase  $W_{RMS}$  current. Facilitates monitoring of imbalance in the motor currents, detection of weak motor cables or imbalance in motor windings.

## Parameter 16-48 Speed Ref. After Ramp [RPM]

Table 866: Parameter 16-48 Speed Ref. After Ramp [RPM]

| 16-48 Speed Ref. After Ramp [RPM] |   |                                |
|-----------------------------------|---|--------------------------------|
| Default value: 0 RPM              | Parameter type: Range, -30000 - 30000 RPM | Setup: All setups              |
| Conversion index: 67              | Data type: Int32                          | Change during operation: False |

This parameter specifies the reference given to the drive after the speed ramp.

## Parameter 16-49 Current Fault Source

Table 867: Parameter 16-49 Current Fault Source

| 16-49 Current Fault Source |                              |                               |
|----------------------------|------------------------------|-------------------------------|
| Default value: 0           | Parameter type: Range, 0 - 8 | Setup: All setups             |
| Conversion index: 0        | Data type: Uint8             | Change during operation: True |

Value indicates source of current faults including short circuit, overcurrent, and imbalance of supply voltage (from left):

- 1–4 Inverter
- 5–8 Rectifier
- 0 No fault recorded

### 5.16.4 16-5\* Ref. & Feedb.

#### Parameter 16-50 External Reference

Table 868: Parameter 16-50 External Reference

| 16-50 External Reference |                                   |                                |
|--------------------------|-----------------------------------|--------------------------------|
| Default value: 0         | Parameter type: Range, -200 - 200 | Setup: All setups              |
| Conversion index: -1     | Data type: Int16                  | Change during operation: False |

View the total reference, the sum of digital, analog, preset, fieldbus, and freeze references, plus catch up and slow down.

#### Parameter 16-51 Pulse Reference

Table 869: Parameter 16-51 Pulse Reference

| 16-51 Pulse Reference |                                   |                                |
|-----------------------|-----------------------------------|--------------------------------|
| Default value: 0      | Parameter type: Range, -200 - 200 | Setup: All setups              |
| Conversion index: -1  | Data type: Int16                  | Change during operation: False |

View the reference value from programmed digital inputs. The readout can also reflect the impulses from an incremental encoder.

#### Parameter 16-52 Feedback[Unit]

Table 870: Parameter 16-52 Feedback[Unit]

| 16-52 Feedback[Unit]                    |   |                                |
|---|---|--------------------------------|
| Default value: 0 ReferenceFeedback-Unit | Parameter type: Range, -999999.999 ReferenceFeedbackUnit - 999999.999 ReferenceFeedbackUnit | Setup: All setups              |
| Conversion index: -3                    | Data type: Int32  | Change during operation: False |

View the feedback unit resulting from the selection of unit and scaling in *parameter 3-00 Reference Range*, *parameter 3-01 Reference/Feedback Unit*, *parameter 3-02 Minimum Reference*, and *parameter 3-03 Maximum Reference*.

#### Parameter 16-53 Digi Pot Reference

Table 871: Parameter 16-53 Digi Pot Reference

| 16-53 Digi Pot Reference |                                   |                                |
|--------------------------|-----------------------------------|--------------------------------|
| Default Value: 0         | Parameter Type: Range, -200 - 200 | Setup: All setups              |
| Conversion Index: -2     | Data Type: Int16                  | Change during operation: False |

View the contribution of the digital potentiometer to the actual reference.

#### Parameter 16-57 Feedback [RPM]

Table 872: Parameter 16-57 Feedback [RPM]

| 16-57 Feedback [RPM] |   |                                |
|----------------------|---|--------------------------------|
| Default Value: 0 RPM | Parameter Type: Range, -30000 - 30000 RPM | Setup: All setups              |
| Conversion Index: 67 | Data Type: Int32                          | Change during operation: False |

Readout parameter where the actual motor RPM from the feedback source can be read in both closed loop and open loop. The feedback source is selected in *parameter 7-00 Speed PID Feedback Source*.

## 5.16.5 16-6\* Inputs and Outputs

### N O T I C E

The following parameters are only available in FC 302:

- *Parameter 16-67 Freq. Input #29 [Hz]*
- *Parameter 16-70 Pulse Output #29 [Hz]*

## Parameter 16-60 Digital Input

Table 873: Parameter 16-60 Digital Input

| 16-60 Digital Input |                                  |                                |
|---------------------|----------------------------------|--------------------------------|
| Default value: 0    | Parameter type: Range, 0 - 65535 | Setup: All setups              |
| Conversion index: 0 | Data type: Uint16                | Change during operation: False |

View the signal states from the active digital inputs. Example: Input 18 corresponds to bit number 5, 0 = no signal, 1 = connected signal. Bit 6 works in the opposite way, on = 0, off = 1 (Safe Torque Off input).

Table 874: Active Digital Inputs

| Bit       | Input  |
|-----------|--|
| 0         | Digital input terminal 33.                                     |
| 1         | Digital input terminal 32.                                     |
| 2         | Digital input terminal 29.                                     |
| 3         | Digital input terminal 27.                                     |
| 4         | Digital input terminal 19.                                     |
| 5         | Digital input terminal 18.                                     |
| 6         | Digital input terminal 37.                                     |
| 7         | Digital input VLT® General Purpose I/O MCB 101 terminal X30/4. |
| 8         | Digital input VLT® General Purpose I/O MCB 101 terminal X30/3. |
| 9         | Digital input VLT® General Purpose I/O MCB 101 terminal X30/2. |
| Bit 10–63 | Reserved for future terminals.                                 |

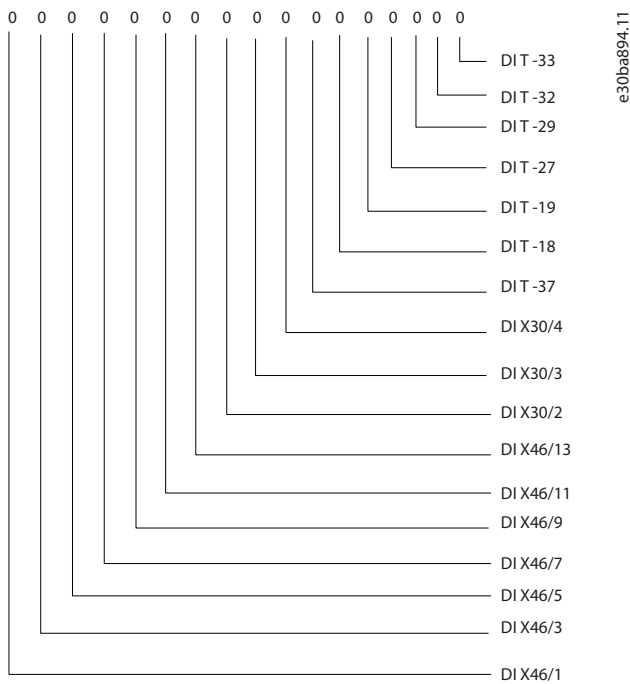

Illustration 92: Relay Settings

Parameter 16-61 Terminal 53 Switch Setting

Table 875: Parameter 16-61 Terminal 53 Switch Setting

| 16-61 Terminal 53 Switch Setting |                        |                                |
|----------------------------------|------------------------|--------------------------------|
| Default value: [0] Current       | Parameter type: Option | Setup: All setups              |
| Conversion index: -              | Data type: Uint8       | Change during operation: False |

View the setting of input terminal 53.

| Option | Name    | Description |
|--------|---------|-------------|
| [0]*   | Current |             |
| [1]    | Voltage |             |

Parameter 16-62 Analog Input 53

Table 876: Parameter 16-62 Analog Input 53

| 16-62 Analog Input 53 |                                 |                                |
|-----------------------|---------------------------------|--------------------------------|
| Default value: 0      | Parameter type: Range, -20 - 20 | Setup: All setups              |
| Conversion index: -3  | Data type: Int32                | Change during operation: False |

View the actual value at input 53.

Parameter 16-63 Terminal 54 Switch Setting

Table 877: Parameter 16-63 Terminal 54 Switch Setting

| 16-63 Terminal 54 Switch Setting |                        |                                |
|----------------------------------|------------------------|--------------------------------|
| Default value: [0] Current       | Parameter type: Option | Setup: All setups              |
| Conversion index: -              | Data type: Uint8       | Change during operation: False |

View the setting of terminal 54.

| Option | Name    | Description |
|--------|---------|-------------|
| [0]*   | Current |             |
| [1]    | Voltage |             |

Parameter 16-64 Analog Input 54

Table 878: Parameter 16-64 Analog Input 54

| 16-64 Analog Input 54 |                                 |                                |
|-----------------------|---------------------------------|--------------------------------|
| Default value: 0      | Parameter type: Range, -20 - 20 | Setup: All setups              |
| Conversion index: -3  | Data type: Int32                | Change during operation: False |

View the actual value at input 54.

Parameter 16-65 Analog Output 42 [mA]

Table 879: Parameter 16-65 Analog Output 42 [mA]

| 16-65 Analog Output 42 [mA] |                               |                                |
|-----------------------------|-------------------------------|--------------------------------|
| Default value: 0            | Parameter type: Range, 0 - 30 | Setup: All setups              |
| Conversion index: -3        | Data type: Int16              | Change during operation: False |

View the actual value at output 42 in mA. The value shown reflects the selection in *parameter 6-50 Terminal 42 Output*.

Parameter 16-66 Digital Output [bin]

Table 880: Parameter 16-66 Digital Output [bin]

| 16-66 Digital Output [bin] |                               |                                |
|----------------------------|-------------------------------|--------------------------------|
| Default value: 0           | Parameter type: Range, 0 - 15 | Setup: All setups              |
| Conversion index: 0        | Data type: Int16              | Change during operation: False |

View the binary value of all digital outputs.

Parameter 16-67 Freq. Input #29 [Hz]

Table 881: Parameter 16-67 Freq. Input #29 [Hz]

| 16-67 Freq. Input #29 [Hz] |                                   |                                |
|----------------------------|-----------------------------------|--------------------------------|
| Default value: 0           | Parameter type: Range, 0 - 130000 | Setup: All setups              |
| Conversion index: 0        | Data type: Int32                  | Change during operation: False |

View the actual frequency rate on terminal 29.

Parameter 16-68 Freq. Input #33 [Hz]

Table 882: Parameter 16-68 Freq. Input #33 [Hz]

| 16-68 Freq. Input #33 [Hz] |                                   |                                |
|----------------------------|-----------------------------------|--------------------------------|
| Default value: 0           | Parameter type: Range, 0 - 130000 | Setup: All setups              |
| Conversion index: 0        | Data type: Int32                  | Change during operation: False |

View the actual value of the frequency applied at terminal 33 as an impulse input.

Parameter 16-69 Pulse Output #27 [Hz]

Table 883: Parameter 16-69 Pulse Output #27 [Hz]

| 16-69 Pulse Output #27 [Hz] |                                  |                                |
|-----------------------------|----------------------------------|--------------------------------|
| Default value: 0            | Parameter type: Range, 0 - 40000 | Setup: All setups              |
| Conversion index: 0         | Data type: Int32                 | Change during operation: False |

View the actual value of pulses applied to terminal 27 in digital output mode.

Parameter 16-70 Pulse Output #29 [Hz]

Table 884: Parameter 16-70 Pulse Output #29 [Hz]

| 16-70 Pulse Output #29 [Hz] |                                  |                                |
|-----------------------------|----------------------------------|--------------------------------|
| Default value: 0            | Parameter type: Range, 0 - 40000 | Setup: All setups              |
| Conversion index: 0         | Data type: Int32                 | Change during operation: False |

View the actual value of pulses at terminal 29 in digital output mode.

Parameter 16-71 Relay Output [bin]

Table 885: Parameter 16-71 Relay Output [bin]

| 16-71 Relay Output [bin] |                                |                                |
|--------------------------|--------------------------------|--------------------------------|
| Default value: 0         | Parameter type: Range, 0 - 511 | Setup: All setups              |
| Conversion index: 0      | Data type: Int16               | Change during operation: False |

View the settings of all relays.

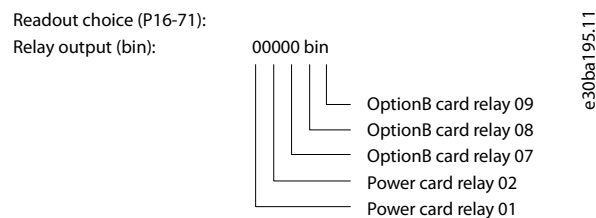

Illustration 93: Relay Settings

Parameter 16-72 Counter A

Table 886: Parameter 16-72 Counter A

| 16-72 Counter A     |   |                               |
|---------------------|---|-------------------------------|
| Default value: 0    | Parameter type: Range, -2147483648 - 2147483647 | Setup: All setups             |
| Conversion index: 0 | Data type: Int32                                | Change during operation: True |

View the present value of counter A. Counters are useful as comparator operands, see *parameter 13-10 Comparator Operand*. Reset or change the value either via digital inputs (*parameter group 5-1\* Digital Inputs*) or by using an SLC action (*parameter 13-52 SL Controller Action*).

Parameter 16-73 Counter B

Table 887: Parameter 16-73 Counter B

| 16-73 Counter B     |   |                               |
|---------------------|---|-------------------------------|
| Default value: 0    | Parameter type: Range, -2147483648 - 2147483647 | Setup: All setups             |
| Conversion index: 0 | Data type: Int32                                | Change during operation: True |

View the present value of counter B. Counters are useful as comparator operands, see *parameter 13-10 Comparator Operand*. Reset or change the value either via digital inputs (*parameter group 5-1\* Digital Inputs*) or by using an SLC action (*parameter 13-52 SL Controller Action*).

Parameter 16-74 Prec. Stop Counter

Table 888: Parameter 16-74 Prec. Stop Counter

| 16-74 Prec. Stop Counter |                                       |                               |
|--------------------------|---------------------------------------|-------------------------------|
| Default value: 0         | Parameter type: Range, 0 - 2147483647 | Setup: All setups             |
| Conversion index: 0      | Data type: Uint32                     | Change during operation: True |

Returns the actual counter value of precise counter (*parameter 1-84 Precise Stop Counter Value*).

Parameter 16-75 Analog In X30/11

Table 889: Parameter 16-75 Analog In X30/11

| 16-75 Analog In X30/11 |                                 |                                |
|------------------------|---------------------------------|--------------------------------|
| Default value: 0       | Parameter type: Range, -20 - 20 | Setup: All setups              |
| Conversion index: -3   | Data type: Int32                | Change during operation: False |

View the actual value at input X30/11 of VLT® General Purpose I/O MCB 101.

Parameter 16-76 Analog In X30/12

Table 890: Parameter 16-76 Analog In X30/12

| 16-76 Analog In X30/12 |                                 |                                |
|------------------------|---------------------------------|--------------------------------|
| Default value: 0       | Parameter type: Range, -20 - 20 | Setup: All setups              |
| Conversion index: -3   | Data type: Int32                | Change during operation: False |

View the actual value at input X30/12 of VLT® General Purpose I/O MCB 101.

Parameter 16-77 Analog Out X30/8 [mA]

Table 891: Parameter 16-77 Analog Out X30/8 [mA]

| 16-77 Analog Out X30/8 [mA] |                               |                                |
|-----------------------------|-------------------------------|--------------------------------|
| Default value: 0            | Parameter type: Range, 0 - 30 | Setup: All setups              |
| Conversion index: -3        | Data type: Int16              | Change during operation: False |

View the actual value at input X30/8 in mA.

Parameter 16-78 Analog Out X45/1 [mA]

Table 892: Parameter 16-78 Analog Out X45/1 [mA]

| 16-78 Analog Out X45/1 [mA] |                               |                                |
|-----------------------------|-------------------------------|--------------------------------|
| Default value: 0            | Parameter type: Range, 0 - 30 | Setup: All setups              |
| Conversion index: -3        | Data type: Int16              | Change during operation: False |

Shows the actual output value at terminal X45/1. The value shown reflects the selection in *parameter 6-70 Terminal X45/1 Output*.

## Parameter 16-79 Analog Out X45/3 [mA]

Table 893: Parameter 16-79 Analog Out X45/3 [mA]

| 16-79 Analog Out X45/3 [mA] |                               |                                |
|-----------------------------|-------------------------------|--------------------------------|
| Default value: 0            | Parameter type: Range, 0 - 30 | Setup: All setups              |
| Conversion index: -3        | Data type: Int16              | Change during operation: False |

Shows the actual output value at terminal X45/3. The value shown reflects the selection in *parameter 6-80 Terminal X45/3 Output*.

## 5.16.6 16-8\* Fieldbus &amp; FC Port

## Parameter 16-80 Fieldbus CTW 1

Table 894: Parameter 16-80 Fieldbus CTW 1

| 16-80 Fieldbus CTW 1 |                                  |                                |
|----------------------|----------------------------------|--------------------------------|
| Default value: 0     | Parameter type: Range, 0 - 65535 | Setup: All setups              |
| Conversion index: 0  | Data type: V2                    | Change during operation: False |

View the 2-byte control word (CTW) received from the bus-master. Interpretation of the CTW depends on the fieldbus option installed and the CTW profile selected in *parameter 8-10 Control Word Profile*. For more information, refer to the relevant fieldbus manual.

## Parameter 16-82 Fieldbus REF 1

Table 895: Parameter 16-82 Fieldbus REF 1

| 16-82 Fieldbus REF 1 |                                   |                                |
|----------------------|-----------------------------------|--------------------------------|
| Default value: 0     | Parameter type: Range, -200 - 200 | Setup: All setups              |
| Conversion index: 0  | Data type: N2                     | Change during operation: False |

View the 2-byte word sent with the control word from the bus-master to set the reference value. For more information, refer to the relevant fieldbus manual.

Table 896: Parameter 16-83 Fieldbus Pos. REF

| 16-83 Fieldbus Pos. REF                |   |                                |
|--|---|--------------------------------|
| Default value: 0 Custom- ReadoutUni t2 | Parameter type: Range, -2147483648 - 2147483647<br>CustomReadoutUnit2 | Setup: All setups              |
| Conversion index: 0                    | Data type: N2   | Change during operation: False |

## NOTICE

This parameter is only valid with software 48.XX.

Shows the 32-bit position reference sent in PCD 2 and PCD 3. In parameters related to PCD 2 and PCD 3, select *[1683] Fieldbus Pos REF* for the fieldbus which is used by the drive. The value is in position units defined in *parameter group 17-7\* Position Scaling*.

## Parameter 16-84 Comm. Option STW

Table 897: Parameter 16-84 Comm. Option STW

| 16-84 Comm. Option STW |                                  |                                |
|------------------------|----------------------------------|--------------------------------|
| Default value: 0       | Parameter type: Range, 0 - 65535 | Setup: All setups              |
| Conversion index: 0    | Data type: V2                    | Change during operation: False |

Show the status word of the extended fieldbus communication option. For more information, refer to the relevant fieldbus manual.



## Parameter 16-85 FC Port CTW 1

Table 898: Parameter 16-85 FC Port CTW 1

| 16-85 FC Port CTW 1 |                                  |                                |
|---------------------|----------------------------------|--------------------------------|
| Default value: 0    | Parameter type: Range, 0 - 65535 | Setup: All setups              |
| Conversion index: 0 | Data type: V2                    | Change during operation: False |

View the 2-byte control word (CTW) received from the fieldbus master. Interpretation of the control word depends on the fieldbus option installed and the control word profile selected in *parameter 8-10 Control Word Profile*.

## Parameter 16-86 FC Port REF 1

Table 899: Parameter 16-86 FC Port REF 1

| 16-86 FC Port REF 1 |                                   |                                |
|---------------------|-----------------------------------|--------------------------------|
| Default value: 0    | Parameter type: Range, -200 - 200 | Setup: All setups              |
| Conversion index: 0 | Data type: N2                     | Change during operation: False |

View the 2-byte status word (STW) sent to the fieldbus master. Interpretation of the status word depends on the fieldbus option installed and the control word profile selected in *parameter 8-10 Control Word Profile*.

## Parameter 16-87 Bus Readout Alarm/Warning

Table 900: Parameter 16-87 Bus Readout Alarm/Warning

| 16-87 Bus Readout Alarm/Warning |   |                                |
|---------------------------------|---|--------------------------------|
| Default value: 0                | Parameter type: Range, 0 - 65535, Array [3] | Setup: All setups              |
| Conversion index: 0             | Data type: Uint16                           | Change during operation: False |

Alarm and warning numbers in hex as shown in the alarm log. The high byte contains the alarm, the low byte contains the warning. The alarm number is the 1<sup>st</sup> that occurred after the last reset.

## Parameter 16-88 Fieldbus Torque FF

Table 901: Parameter 16-88 Fieldbus Torque FF

| 16-88 Fieldbus Torque FF |                                   |                               |
|--------------------------|-----------------------------------|-------------------------------|
| Default value: 0         | Parameter type: Range, -200 - 200 | Setup: 1 setup                |
| Conversion index: 0      | Data type: N2                     | Change during operation: True |

A PCD write reference parameter. This parameter allows the PLC to adjust the Torque FF over the fieldbus continuously as a percentage of motor nominal torque, see *parameter 1-26 Motor Cont. Rated Torque*.

## Parameter 16-89 Configurable Alarm/Warning Word

Table 902: Parameter 16-89 Configurable Alarm/Warning Word

| 16-89 Configurable Alarm/Warning Word |                                  |                                |
|---------------------------------------|----------------------------------|--------------------------------|
| Default Value: 0                      | Parameter Type: Range, 0 - 65535 | Setup: All setups              |
| Conversion Index: 0                   | Data Type: Uint16                | Change during operation: False |

This alarm/warning word is configured in *parameter 8-17 Configurable Alarm and Warningword* to match the actual requirements.

## 5.16.7 16-9\* Diagnosis Readouts

For details of bit descriptions, refer to [Table 1436](#).

## Parameter 16-90 Alarm Word

Table 903: Parameter 16-90 Alarm Word

| 16-90 Alarm Word    |                                       |                                |
|---------------------|---------------------------------------|--------------------------------|
| Default value: 0    | Parameter type: Range, 0 - 4294967295 | Setup: All setups              |
| Conversion index: 0 | Data type: Uint32                     | Change during operation: False |

Show the alarm word sent via the serial communication port in hex code.

## Parameter 16-91 Alarm Word 2

Table 904: Parameter 16-91 Alarm Word 2

| 16-91 Alarm Word 2  |                                       |                                |
|---------------------|---------------------------------------|--------------------------------|
| Default value: 0    | Parameter type: Range, 0 - 4294967295 | Setup: All setups              |
| Conversion index: 0 | Data type: Uint32                     | Change during operation: False |

Show the alarm word sent via the serial communication port in hex code.

## Parameter 16-92 Warning Word

Table 905: Parameter 16-92 Warning Word

| 16-92 Warning Word  |                                       |                                |
|---------------------|---------------------------------------|--------------------------------|
| Default value: 0    | Parameter type: Range, 0 - 4294967295 | Setup: All setups              |
| Conversion index: 0 | Data type: Uint32                     | Change during operation: False |

Show the warning word sent via the serial communication port in hex code.

## Parameter 16-93 Warning Word 2

Table 906: Parameter 16-93 Warning Word 2

| 16-93 Warning Word 2 |                                       |                                |
|----------------------|---------------------------------------|--------------------------------|
| Default value: 0     | Parameter type: Range, 0 - 4294967295 | Setup: All setups              |
| Conversion index: 0  | Data type: Uint32                     | Change during operation: False |

Show the warning word sent via the serial communication port in hex code.

## Parameter 16-94 Ext. Status Word

Table 907: Parameter 16-94 Ext. Status Word

| 16-94 Ext. Status Word |                                       |                                |
|------------------------|---------------------------------------|--------------------------------|
| Default value: 0       | Parameter type: Range, 0 - 4294967295 | Setup: All setups              |
| Conversion index: 0    | Data type: Uint32                     | Change during operation: False |

Returns the extended status word sent via the serial communication port in hex code.

## Parameter 16-95 Ext. Status Word 2

Table 908: Parameter 16-95 Ext. Status Word 2

| 16-95 Ext. Status Word 2 |                                       |                                |
|--------------------------|---------------------------------------|--------------------------------|
| Default value: 0         | Parameter type: Range, 0 - 4294967295 | Setup: All setups              |
| Conversion index: 0      | Data type: Uint32                     | Change during operation: False |

Returns the extended warning word sent via the serial communication port in hex code.

## Parameter 16-96 Maintenance Word

Table 909: Parameter 16-96 Maintenance Word

| 16-96 Maintenance Word |                                       |                                |
|------------------------|---------------------------------------|--------------------------------|
| Default value: 0       | Parameter type: Range, 0 - 4294967295 | Setup: All setups              |
| Conversion index: 0    | Data type: Uint32                     | Change during operation: False |

Readout of the preventive maintenance word. The bits reflect the status for the programmed preventive maintenance events in *parameter group 23-1\* Maintenance*. 13 bits show combinations of all the possible items:

- Bit 0: Motor bearings
- Bit 1: Pump bearings
- Bit 2: Fan bearings
- Bit 3: Valve
- Bit 4: Pressure transmitter
- Bit 5: Flow transmitter
- Bit 6: Temperature transmitter
- Bit 7: Pump seals
- Bit 8: Fan belt
- Bit 9: Filter
- Bit 10: Drive cooling fan
- Bit 11: Drive system health check
- Bit 12: Warranty
- Bit 13: Maintenance text 0
- Bit 14: Maintenance text 1
- Bit 15: Maintenance text 2
- Bit 16: Maintenance text 3
- Bit 17: Maintenance text 4

The following table details the display of the maintenance word.

Table 910: Maintenance Word

| Position 4⇒      | Valve                     | Fan bearings            | Pump bearings    | Motor bearings       |
|------------------|---------------------------|-------------------------|------------------|----------------------|
| Position 3⇒      | Pump seals                | Temperature transmitter | Flow transmitter | Pressure transmitter |
| Position 2⇒      | Drive system health check | Drive cooling fan       | Filter           | Fan belt             |
| Position 1⇒      | –                         | –                       | –                | Warranty             |
| 0 <sub>hex</sub> | –                         | –                       | –                | –                    |
| 1 <sub>hex</sub> | –                         | –                       | –                | +                    |
| 2 <sub>hex</sub> | –                         | –                       | +                | –                    |
| 3 <sub>hex</sub> | –                         | –                       | +                | +                    |
| 4 <sub>hex</sub> | –                         | +                       | –                | –                    |
| 5 <sub>hex</sub> | –                         | +                       | –                | +                    |
| 6 <sub>hex</sub> | –                         | +                       | +                | –                    |
| 7 <sub>hex</sub> | –                         | +                       | +                | +                    |

| Position 4⇒      | Valve                     | Fan bearings            | Pump bearings    | Motor bearings       |
|------------------|---------------------------|-------------------------|------------------|----------------------|
| Position 3⇒      | Pump seals                | Temperature transmitter | Flow transmitter | Pressure transmitter |
| Position 2⇒      | Drive system health check | Drive cooling fan       | Filter           | Fan belt             |
| Position 1⇒      | –                         | –                       | –                | Warranty             |
| 8 <sub>hex</sub> | +                         | –                       | –                | –                    |
| 9 <sub>hex</sub> | +                         | –                       | –                | +                    |
| A <sub>hex</sub> | +                         | –                       | +                | –                    |
| B <sub>hex</sub> | +                         | –                       | +                | +                    |
| C <sub>hex</sub> | +                         | +                       | –                | –                    |
| D <sub>hex</sub> | +                         | +                       | –                | +                    |
| E <sub>hex</sub> | +                         | +                       | +                | –                    |
| F <sub>hex</sub> | +                         | +                       | +                | +                    |

**Example:** The preventive maintenance word shows 040Ahex:

|           |   |   |   |   |
|-----------|---|---|---|---|
| Position  | 1 | 2 | 3 | 4 |
| Hex value | 0 | 4 | 0 | A |

- The 1<sup>st</sup> digit 0 indicates that no items from the 4<sup>th</sup> row require maintenance.
- The 2<sup>nd</sup> digit 4 refers to the 3<sup>rd</sup> row indicating that the drive cooling fan requires maintenance.
- The 3<sup>rd</sup> digit 0 indicates that no items for the 2<sup>nd</sup> row require maintenance.
- The 4<sup>th</sup> digit A refers to the top row indicating that the valve and the pump bearings require maintenance.

### Parameter 16-97 Alarm Word 3

Table 911: Parameter 16-97 Alarm Word 3

| 16-97 Alarm Word 3  |                                       |                                |
|---------------------|---------------------------------------|--------------------------------|
| Default value: 0    | Parameter type: Range, 0 - 4294967295 | Setup: All setups              |
| Conversion index: 0 | Data type: Uint32                     | Change during operation: False |

Shows the alarm word sent via the serial communication port in hex code.

### Parameter 16-98 Warning Word 3

Table 912: Parameter 16-98 Warning Word 3

| 16-98 Warning Word 3 |                                       |                                |
|----------------------|---------------------------------------|--------------------------------|
| Default value: 0     | Parameter type: Range, 0 - 4294967295 | Setup: All setups              |
| Conversion index: 0  | Data type: Uint32                     | Change during operation: False |

Shows the warning word sent via the serial communication port in hex code.

## 5.17 Parameter Group 17-\*\* Feedback

Parameters for configuring the feedback from VLT® Encoder Input MCB 102, VLT® Resolver Input MCB 103m or the drive itself.

### 5.17.1 17-0\* Encoder Interface

#### Parameter 17-00 Encoders Connected

Table 913: Parameter 17-00 Encoders Connected

| 17-00 Encoders Connected       |                        |                                |
|--------------------------------|------------------------|--------------------------------|
| Default value: [0] One encoder | Parameter type: Option | Setup: All setups              |
| Conversion index: -            | Data type: Uint8       | Change during operation: False |

## N O T I C E

This parameter is only available with VLT® Encoder Option MCB 102 version 4.00 or newer.

Select if 1 or 2 encoders are connected to MCB 102.

| Option | Name         | Description   |
|--------|--------------|---|
| [0]*   | One encoder  | Only 1 encoder is connected. The encoder can be any of the supported encoder types.   |
| [1]    | Two encoders | Two encoders are connected. The encoders must be 1 incremental (TTL or SinCos) and 1 absolute (SSI or Endat) without incremental channel. |

#### Parameter 17-01 Standby Encoder

Table 914: Parameter 17-01 Standby Encoder

| 17-01 Standby Encoder   |                        |                                |
|-------------------------|------------------------|--------------------------------|
| Default value: [0] None | Parameter type: Option | Setup: All setups              |
| Conversion index: -     | Data type: Uint8       | Change during operation: False |

Select the source for the standby encoder which will be used as feedback if the primary encoder fails.

| Option | Name                      | Description                                       |
|--------|---------------------------|---|
| [0]*   | None                      | No standby encoder.                               |
| [1]    | Standby encoder to T32/33 | Standby encoder connected to terminals 32 and 33. |
| [2]    | Standby encoder to T27/29 | Standby encoder connected to terminals 27 and 29. |

### 5.17.2 17-1\* Inc. Enc. Interface

## N O T I C E

Do not use incremental encoders with PM motors. In a closed-loop control, consider absolute encoders or resolvers.

## N O T I C E

These parameters cannot be adjusted while the motor is running.

Parameters in this group configure the incremental interface of the VLT® Encoder Input MCB 102. Both the incremental and absolute interfaces are active at the same time.

## Parameter 17-10 Signal Type

Table 915: Parameter 17-10 Signal Type

| 17-10 Signal Type                 |                        |                                |
|-----------------------------------|------------------------|--------------------------------|
| Default value: [1] RS422 (5V TTL) | Parameter type: Option | Setup: All setups              |
| Conversion index: -               | Data type: Uint8       | Change during operation: False |

Select this parameter if 1 or 2 encoders are connected to MCB 102.

| Option | Name            | Description |
|--------|-----------------|-------------|
| [0]    | None            |             |
| [1]*   | RS422 (5V TTL)  |             |
| [2]    | Sinosoidal 1Vpp |             |

## Parameter 17-11 Resolution (PPR)

Table 916: Parameter 17-11 Resolution (PPR)

| 17-11 Resolution (PPR) |                                   |                                |
|------------------------|-----------------------------------|--------------------------------|
| Default value: 1024    | Parameter type: Range, 10 - 16384 | Setup: All setups              |
| Conversion index: 0    | Data type: Uint16                 | Change during operation: False |

Enter the number of pulses or periods per revolution (the incremental track).

## 5.17.3 17-2\* Abs. Enc. Interface

Parameters in this group configure the absolute interface of the VLT® Encoder Input MCB 102. Both the incremental and absolute interfaces are active at the same time.

## Parameter 17-20 Protocol Selection

Table 917: Parameter 17-20 Protocol Selection

| 17-20 Protocol Selection |                        |                                |
|--------------------------|------------------------|--------------------------------|
| Default value: [0] None  | Parameter type: Option | Setup: All setups              |
| Conversion index: -      | Data type: Uint8       | Change during operation: False |

## N O T I C E

This parameter cannot be adjusted while the motor is running.

| Option | Name      | Description   |
|--------|-----------|---|
| [0]*   | None      | Select [0] <i>None</i> if the feedback sensor is an incremental encoder only.   |
| [1]    | HIPERFACE | Select [1] <i>HIPERFACE</i> if the encoder is absolute only.                    |
| [2]    | EnDat     |   |
| [4]    | SSI       |   |
| [8]    | Z pulse   | Select 0 pulse as "absolute" track when using incremental encoder with 0 pulse. |

## Parameter 17-21 Resolution (Positions/Rev)

Table 918: Parameter 17-21 Resolution (Positions/Rev)

| 17-21 Resolution (Positions/Rev) |                                       |                                |
|----------------------------------|---------------------------------------|--------------------------------|
| Default value: Size related      | Parameter type: Range, 4 - 1073741824 | Setup: All setups              |
| Conversion index: 0              | Data type: Uint32                     | Change during operation: False |

Select the resolution of the absolute encoder, that is the number of counts per revolution. The value depends on setting in *parameter 17-20 Protocol Selection*.

## Parameter 17-22 Multiturn Revolutions

Table 919: Parameter 17-22 Multiturn Revolutions

| 17-22 Multiturn Revolutions |                                     |                                |
|-----------------------------|-------------------------------------|--------------------------------|
| Default value: 1            | Parameter type: Range, 1 - 16777216 | Setup: All setups              |
| Conversion index: 0         | Data type: Uint32                   | Change during operation: False |

Select the number of multi-turn revolutions. Select value 1 for single-turn type encoders.

## Parameter 17-24 SSI Data Length

Table 920: Parameter 17-24 SSI Data Length

| 17-24 SSI Data Length |                               |                                |
|-----------------------|-------------------------------|--------------------------------|
| Default value: 13     | Parameter type: Range, 1 - 32 | Setup: All setups              |
| Conversion index: 0   | Data type: Uint8              | Change during operation: False |

Set the number of bits for the SSI telegram. Select 13 bits for singleturn encoders and 25 bits for multiturn encoders.

## Parameter 17-25 Clock Rate

Table 921: Parameter 17-25 Clock Rate

| 17-25 Clock Rate       |                                      |                                |
|------------------------|--------------------------------------|--------------------------------|
| Default value: 260 kHz | Parameter type: Range, 100 - 260 kHz | Setup: All setups              |
| Conversion index: 3    | Data type: Uint16                    | Change during operation: False |

Set the SSI clock rate. With long encoder cables, the clock rate must be reduced.

## Parameter 17-26 SSI Data Format

Table 922: Parameter 17-26 SSI Data Format

| 17-26 SSI Data Format        |                        |                                |
|------------------------------|------------------------|--------------------------------|
| Default value: [0] Gray code | Parameter type: Option | Setup: All setups              |
| Conversion index: -          | Data type: Uint8       | Change during operation: False |

| Option | Name        | Description                          |
|--------|-------------|--------------------------------------|
| [0]*   | Gray code   |                                      |
| [1]    | Binary code | Set the data format of the SSI data. |

## Parameter 17-34 HIPERFACE Baudrate

Table 923: Parameter 17-34 HIPERFACE Baudrate

| 17-34 HIPERFACE Baudrate |                        |                                |
|--------------------------|------------------------|--------------------------------|
| Default value: [4] 9600  | Parameter type: Option | Setup: All setups              |
| Conversion index: -      | Data type: Uint8       | Change during operation: False |

### N O T I C E

This parameter cannot be adjusted while the motor is running.

Select the baud rate of the attached encoder. The parameter is only accessible when *parameter 17-20 Protocol Selection* is set to [1] *HIPERFACE*.

| Option | Name  | Description |
|--------|-------|-------------|
| [0]    | 600   |             |
| [1]    | 1200  |             |
| [2]    | 2400  |             |
| [3]    | 4800  |             |
| [4]*   | 9600  |             |
| [5]    | 19200 |             |
| [6]    | 38400 |             |

## 5.17.4 17-4\* Fieldbus Reference 2

## Parameter 17-40 Fieldbus Sync. Delta

Table 924: Parameter 17-40 Fieldbus Sync. Delta

| 17-40 Fieldbus Sync. Delta |   |                               |
|----------------------------|---|-------------------------------|
| Default value: 0           | Parameter type: Range, -2147483648 - 2147483647 | Setup: 1 setup                |
| Conversion index: 0        | Data type: Int32                                | Change during operation: True |

### N O T I C E

This parameter is only available with software version 48.XX.

Shows the fieldbus synchronizing master position change = master speed when transferred by PCD from fieldbus master.

## Parameter 17-41 Fieldbus Profile Velocity

Table 925: Parameter 17-41 Fieldbus Profile Velocity

| 17-41 Fieldbus Profile Velocity |  |                               |
|---------------------------------|--|-------------------------------|
| Default value: 0                | Parameter type: Range, 0 - 2147483647 pu/s | Setup: 1 setup                |
| Conversion index: 0             | Data type: Int32                           | Change during operation: True |

### N O T I C E

This parameter is only available with software version 48.XX.

Velocity reference for the profile generator in positioning mode or when using Mode of operation and Profile ositioning mode.



Parameter 17-42 Fieldbus Velocity FF.

Table 926: Parameter 17-42 Fieldbus Velocity FF.

| 17-42 Fieldbus Velocity FF. |  |                               |
|-----------------------------|--|-------------------------------|
| Default value: 0            | Parameter type: Range, -2147483648 - 2147483647 pu/s | Setup: 1 setup                |
| Conversion index: 0         | Data type: Int32                                     | Change during operation: True |

### N O T I C E

This parameter is only available with software version 48.XX.

Velocity feedforward when running in cyclic sync. position mode.

Parameter 17-43 Fieldbus Acceleration FF.

Table 927: Parameter 17-43 Fieldbus Acceleration FF.

| 17-43 Fieldbus Acceleration FF. |   |                               |
|---------------------------------|---|-------------------------------|
| Default value: 0                | Parameter type: Range, -2147483648 - 2147483647 pu/s <sup>2</sup> | Setup: 1 setup                |
| Conversion index: 0             | Data type: Int32  | Change during operation: True |

### N O T I C E

This parameter is only available with software version 48.XX.

Acceleration feedforward when running cyclic sync. position or cyclic sync. velocity mode.

Parameter 17-44 Fieldbus Target Velocity

Table 928: Parameter 17-44 Fieldbus Target Velocity

| 17-44 Fieldbus Target Velocity |  |                               |
|--------------------------------|--|-------------------------------|
| Default value: 0               | Parameter type: Range, -2147483648 - 2147483647 pu/s | Setup: 1 setup                |
| Conversion index: 0            | Data type: Int32                                     | Change during operation: True |

### N O T I C E

This parameter is only available with software version 48.XX.

Velocity reference when running cyclic sync. velocity mode.

## 5.17.5 17-5\* Resolver Interface

This parameter group is used for setting parameters for the VLT® Resolver Input MCB 103. Usually, the resolver feedback is used as motor feedback from permanent magnet motors with *parameter 1-01 Motor Control Principle* set to [3] *Flux w/motor feedback*. Resolver parameters cannot be adjusted while the motor is running.

Parameter 17-50 Poles

Table 929: Parameter 17-50 Poles

| 17-50 Poles         |                              |                                |
|---------------------|------------------------------|--------------------------------|
| Default value: 2    | Parameter type: Range, 2 - 8 | Setup: 1 setup                 |
| Conversion index: 0 | Data type: Uint8             | Change during operation: False |

Set the pole number on the resolver. The value is stated in the datasheet for resolvers.

## Parameter 17-51 Input Voltage

Table 930: Parameter 17-51 Input Voltage

| 17-51 Input Voltage  |                                |                                |
|----------------------|--------------------------------|--------------------------------|
| Default value: 7 V   | Parameter type: Range, 2 - 8 V | Setup: 1 setup                 |
| Conversion index: -1 | Data type: Uint8               | Change during operation: False |

Set the input voltage to the resolver. The voltage is stated as RMS value. The value is stated in the datasheet for resolvers.

## Parameter 17-52 Input Frequency

Table 931: Parameter 17-52 Input Frequency

| 17-52 Input Frequency |                                   |                                |
|-----------------------|-----------------------------------|--------------------------------|
| Default value: 10 kHz | Parameter type: Range, 2 - 15 kHz | Setup: 1 setup                 |
| Conversion index: 2   | Data type: Uint8                  | Change during operation: False |

Set the input frequency to the resolver. The value is stated in the datasheet for resolvers.

## Parameter 17-53 Transformation Ratio

Table 932: Parameter 17-53 Transformation Ratio

| 17-53 Transformation Ratio |                                  |                                |
|----------------------------|----------------------------------|--------------------------------|
| Default value: 0.5         | Parameter type: Range, 0.1 - 1.1 | Setup: 1 setup                 |
| Conversion index: -1       | Data type: Uint8                 | Change during operation: False |

Set the transformation ratio for the resolver. The transformation ratio is:

$$T_{\text{ratio}} = \frac{V_{\text{out}}}{V_{\text{in}}}$$

The value is stated in the datasheet for resolvers.

## Parameter 17-56 Encoder Sim. Resolution

Table 933: Parameter 17-56 Encoder Sim. Resolution

| 17-56 Encoder Sim. Resolution |                        |                                |
|-------------------------------|------------------------|--------------------------------|
| Default Value: [0] Disabled   | Parameter Type: Option | Setup: All setups              |
| Conversion Index: -           | Data Type: Uint8       | Change during operation: False |

Set the resolution and activate the encoder emulation function (generation of encoder signals from the measured position from a resolver). Use this function to transfer the speed or position information from 1 drive to another. To disable the function, select [0] Disabled.

| Option | Name                     | Description   |
|--------|--------------------------|---|
| [0]*   | Disabled                 |   |
| [1]    | 512                      |   |
| [2]    | 1024                     |   |
| [3]    | 2048                     |   |
| [4]    | 4096                     |   |
| [5]    | Enable encoder sim. adv. | Set the encoder simulation resolution via <i>parameter 17-58 Encoder Sim. Resolution Adv.</i> |

Parameter 17-58 Encoder Sim. Resolution Adv.

Table 934: Parameter 17-58 Encoder Sim. Resolution Adv.

| 17-58 Encoder Sim. Resolution Adv. |                                  |                                |
|------------------------------------|----------------------------------|--------------------------------|
| Default value: 0                   | Parameter type: Range, 0 - 16384 | Setup: 1 setup                 |
| Conversion index: 0                | Data type: Uint16                | Change during operation: False |

Set the encoder simulation resolution as a continuous value in steps of 1. This parameter is only active when [5] *Enable encoder sim. adv.* is selected in *parameter 17-56 Encoder Sim. Resolution*.

Parameter 17-59 Resolver Interface

Table 935: Parameter 17-59 Resolver Interface

| 17-59 Resolver Interface    |                        |                                |
|-----------------------------|------------------------|--------------------------------|
| Default value: [0] Disabled | Parameter type: Option | Setup: All setups              |
| Conversion index: -         | Data type: Uint8       | Change during operation: False |

Activate the VLT® Resolver Input MCB 103 when the resolver parameters are selected. To avoid damage to resolvers, adjust *parameter 17-50 Poles* and *parameter 17-53 Transformation Ratio* before enabling this parameter.

| Option | Name     | Description |
|--------|----------|-------------|
| [0]*   | Disabled |             |
| [1]    | 512      |             |

### 5.17.6 17-6\* Monitoring and Application

#### NOTICE

The following parameters are only available in FC 302:

- *Parameter 17-67 Raw Inc. Quad Counter*
- *Parameter 17-68 Raw Abs. Pos. Low*
- *Parameter 17-69 Raw Abs. Pos. High*

This parameter group is for selecting extra functions when VLT® Encoder MCB 102 or VLT® Resolver Input MCB 103 is fitted into option slot B as speed feedback. Monitoring and application parameters cannot be adjusted while the motor is running.

Parameter 17-60 Feedback Direction

Table 936: Parameter 17-60 Feedback Direction

| 17-60 Feedback Direction     |                        |                                |
|------------------------------|------------------------|--------------------------------|
| Default value: [0] Clockwise | Parameter type: Option | Setup: All setups              |
| Conversion index: -          | Data type: Uint8       | Change during operation: False |

#### NOTICE

This parameter cannot be adjusted while the motor is running.

Change the detected encoder rotation direction without changing the wiring to the encoder.

| Option | Name              | Description |
|--------|-------------------|-------------|
| [0]*   | Clockwise         |             |
| [1]    | Counter clockwise |             |

## Parameter 17-61 Feedback Signal Monitoring

Table 937: Parameter 17-61 Feedback Signal Monitoring

| 17-61 Feedback Signal Monitoring |                        |                                |
|----------------------------------|------------------------|--------------------------------|
| Default value: [1] Warning       | Parameter type: Option | Setup: All setups              |
| Conversion index: -              | Data type: Uint8       | Change during operation: False |

Select which action the drive should take if a faulty encoder signal is detected. The encoder function in *parameter 17-61 Feedback Signal Monitoring* is an electrical check of the hardware circuit in the encoder system.

| Option | Name                | Description |
|--------|---------------------|-------------|
| [0]    | Disabled            |             |
| [1]*   | Warning             |             |
| [2]    | Trip                |             |
| [3]    | Jog                 |             |
| [4]    | Freeze output       |             |
| [5]    | Max speed           |             |
| [6]    | Switch to open loop |             |
| [7]    | Select setup 1      |             |
| [8]    | Select setup 2      |             |
| [9]    | Select setup 3      |             |
| [10]   | Select setup 4      |             |
| [11]   | Stop & trip         |             |
| [12]   | Trip/warning        |             |
| [13]   | Trip/catch          |             |

## Parameter 17-67 Raw Inc. Quad Counter

Table 938: Parameter 17-67 Raw Inc. Quad Counter

| 17-67 Raw Inc. Quad Counter |                                  |                                |
|-----------------------------|----------------------------------|--------------------------------|
| Default value: 0            | Parameter type: Range, 0 - 65535 | Setup: All setups              |
| Conversion index: 0         | Data type: Uint16                | Change during operation: False |

## N O T I C E

This parameter is only available with software version 48.9X.

Shows the raw incremental counter value in quad counts (4 times pulse count) of an encoder connected to VLT® Encoder Input MCB 102. It can be an incremental encoder or the incremental part of a dual-channel absolute encoder. MCB 102 must be selected as

feedback source in *parameter 1-02 Flux Motor Feedback Source*, *parameter 7-00 Speed PID Feedback Source*, or *parameter 7-90 Position PI Feedback Source*.

Parameter 17-68 Raw Abs. Pos. Low

Table 939: Parameter 17-68 Raw Abs. Pos. Low

| 17-68 Raw Abs. Pos. Low |                                       |                                |
|-------------------------|---------------------------------------|--------------------------------|
| Default value: 0        | Parameter type: Range, 0 - 2147483647 | Setup: All setups              |
| Conversion index: 0     | Data type: Uint32                     | Change during operation: False |

### NOTICE

This parameter is only available with software version 48.9X.

Shows the least significant 32 bits of the position value read from an absolute encoder connected to VLT® Encoder Input MCB 102. MCB 102 must be selected as feedback source in *parameter 1-02 Flux Motor Feedback Source*, *parameter 7-00 Speed PID Feedback Source*, or *parameter 7-90 Position PI Feedback Source*.

Parameter 17-69 Raw Abs. Pos. High

Table 940: Parameter 17-69 Raw Abs. Pos. High

| 17-69 Raw Abs. Pos. High |                                       |                                |
|--------------------------|---------------------------------------|--------------------------------|
| Default value: 0         | Parameter type: Range, 0 - 2147483647 | Setup: All setups              |
| Conversion index: 0      | Data type: Uint32                     | Change during operation: False |

### NOTICE

This parameter is only available with software version 48.9X.

Shows the most significant 32 bits of the position value read from an absolute encoder connected to VLT® Encoder Input MCB 102. MCB 102 must be selected as feedback source in *parameter 1-02 Flux Motor Feedback Source*, *parameter 7-00 Speed PID Feedback Source*, or *parameter 7-90 Position PI Feedback Source*.

## 5.17.7 17-7\* Position Scaling

Parameters in this group define how the drive scales and handles the position values.

Parameter 17-70 Position Unit

Table 941: Parameter 17-70 Position Unit

| 17-70 Position Unit   |                        |                                |
|-----------------------|------------------------|--------------------------------|
| Default value: [0] pu | Parameter type: Option | Setup: All setups              |
| Conversion index: -   | Data type: Uint8       | Change during operation: False |

Select the physical unit for showing the position values on the LCP.

| Option | Name | Description    |
|--------|------|----------------|
| [0]*   | pu   | Position unit. |
| [1]    | m    | Meters.        |
| [2]    | mm   | Millimeters    |
| [3]    | inc  | Increments.    |
| [4]    | °    | Degrees.       |

| Option | Name | Description  |
|--------|------|--|
| [5]    | rad  | Radian.  |
| [6]    | %    | Percent.   |
| [7]    | qc   | Quad count, which is ¼ of an encoder pulse when using quadrature encoder signal. |

### Parameter 17-71 Position Unit Scale

Table 942: Parameter 17-71 Position Unit Scale

| 17-71 Position Unit Scale |  |                                |
|---------------------------|--|--------------------------------|
| Default value: 0          | Parameter type: Range, -3 - 3, Array [2] | Setup: All setups              |
| Conversion index: 0       | Data type: Int8                          | Change during operation: False |

Enter the scaling factor for the position values. The scaling function multiplies the readout values by  $10^x$ , where x is the value of this parameter. For example, if x = 2, the value 5 is shown as 500. The elements of the array are:

- Index 0 is the scaling factor for readout and settings of position values in parameters or in a fieldbus. Index 1 contains exceptions.
- Index 1 is the scaling factor for readout of position error (*parameter 16-08 Position Error*) and for the value of *parameter 3-08 On Target Window*.

### Parameter 17-72 Position Unit Numerator

Table 943: Parameter 17-72 Position Unit Numerator

| 17-72 Position Unit Numerator |   |                                |
|-------------------------------|---|--------------------------------|
| Default value: 1024           | Parameter type: Range, -2147483648 - 2147483647 | Setup: All setups              |
| Conversion index: 0           | Data type: Int32                                | Change during operation: False |

This parameter is the numerator in the equation which defines the relation between 1 motor revolution and physical movement of machine.

$$\text{Position unit} = \frac{\text{Par. 17-72}}{\text{Par. 17-73}} \times \text{Motor revolutions}$$

Example: Consider a turn table application. The motor makes 10 revolutions when the table makes 1 revolution. The position unit is a degree. For this setup, enter the following values:

- *Parameter 17-72 Position Unit Numerator* = 360
- *Parameter 17-73 Position Unit Denominator* = 10

Set the physical unit for position values in *parameter 17-70 Position Unit*.

### Parameter 17-73 Position Unit Denominator

Table 944: Parameter 17-73 Position Unit Denominator

| 17-73 Position Unit Denominator |   |                                |
|---------------------------------|---|--------------------------------|
| Default value: 1                | Parameter type: Range, -2147483648 - 2147483647 | Setup: All setups              |
| Conversion index: 0             | Data type: Int32                                | Change during operation: False |

See *parameter 17-72 Position Unit Numerator*.

Parameter 17-74 Position Offset

Table 945: Parameter 17-74 Position Offset

| 17-74 Position Offset |   |                                |
|-----------------------|---|--------------------------------|
| Default value: 0      | Parameter type: Range, -2147483648 - 2147483647 | Setup: All setups              |
| Conversion index: 0   | Data type: Int32                                | Change during operation: False |

Enter the absolute encoder position offset. Use this parameter to adjust the 0 position of the encoder without physically moving the encoder. Set the physical unit for position values in *parameter 17-70 Position Unit*.

Parameter 17-75 Position Recovery at Power-up

Table 946: Parameter 17-75 Position Recovery at Power-up

| 17-75 Position Recovery at Power-up |                        |                                |
|-------------------------------------|------------------------|--------------------------------|
| Default value: [0] Off              | Parameter type: Option | Setup: All setups              |
| Conversion index: -                 | Data type: Uint8       | Change during operation: False |

**NOTICE**

This parameter is only available with software version 48.XX.

Select the actual position after power-up when using open loop or incremental encoders.

| Option | Name | Description   |
|--------|------|---|
| [0]*   | Off  | The actual position is 0 after power-up.  |
| [1]    | On   | This drive stores the actual position at power-down and uses it as the actual position when powered up. |

Parameter 17-76 Position Axis Mode

Table 947: Parameter 17-76 Position Axis Mode

| 17-76 Position Axis Mode       |                        |                                |
|--------------------------------|------------------------|--------------------------------|
| Default value: [0] Linear axis | Parameter type: Option | Setup: All setups              |
| Conversion index: -            | Data type: Uint8       | Change during operation: False |

**NOTICE**

This parameter is only available with software version 48.XX.

Select the axis type for position counting.

| Option | Name             | Description  |
|--------|------------------|--|
| [0]*   | Linear axis      | The motion is within a position range defined by <i>parameter 3-06 Minimum Position</i> and <i>parameter 3-07 Maximum Position</i> .                                 |
| [1]    | Rotary 0 - Max   | Continuous motion, where the position changes between 0 and <i>parameter 3-07 Maximum Position</i> . When passing the maximum position, the reading restarts from 0. |
| [2]    | Rotary min - max | <div style="text-align: center;"><b>NOTICE</b></div> <p>This option is available only with software version 48.20 and newer.</p>                                     |

| Op-tion | Name | Description  |
|---------|------|--|
|         |      | Continuous motion, where the position changes between <i>parameter 3-06 Minimum Position</i> and <i>parameter 3-07 Maximum Position</i> . When passing the maximum position, the reading restarts from the minimum position. |

Parameter 17-77 Position Feedback Mode

Table 948: Parameter 17-77 Position Feedback Mode

| 17-77 Position Feedback Mode |                        |                                |
|------------------------------|------------------------|--------------------------------|
| Default value: [0] Relative  | Parameter type: Option | Setup: All setups              |
| Conversion index: -          | Data type: Uint8       | Change during operation: False |

**NOTICE**

This parameter is only available with software version 48.20.

Select the mode for handling absolute encoders. Select [0] *Relative* if the application requires tracking the position when the position value exceeds the measuring range of the encoder, for example, when using single-turn encoders for linear motion. Select [1] *Absolute* if the position values are always within the measuring range of the encoder, for example, when using a laser distance-measuring device.

| Op-tion | Name     | Description   |
|---------|----------|---|
| [0]*    | Relative | The actual position is set to the absolute position read from the encoder at power-up, and then the drive uses only the position changes for calculating the actual position. In this mode, the actual position values are between -2147483648 and 2147483647 even when the values exceed the measuring range of the encoder. To save and use the absolute position values outside the measuring range of the encoder after power-down, set <i>parameter 17-75 Position Recovery at Power-up</i> to [1] <i>On</i> . The position value is accurate if the encoder does not move by more than half of the encoder measuring range when the drive is powered down.  |
| [1]     | Absolute | The drive uses the absolute position from the encoder as actual position continuously. In this mode, the actual position values are between 0 and the maximum position of the encoder. The maximum position is determined by the number of bits, for example, the SSI encoder has 25 bits and its maximum value is $2^{25} = 33554432$ . Set <i>parameter 3-07 Maximum Position</i> to the maximum value of the encoder scaled according to <i>parameter 7-94 Position PI Feedback Scale Numerator</i> , <i>parameter 7-95 Position PI Feedback Scale Denominator</i> , <i>parameter 17-72 Position Unit Numerator</i> , and <i>parameter 17-73 Position Unit Denominator</i> . If the position exceeds the measuring range of the encoder, the absolute position reference is lost. For example, use this option if there is a laser distance-measuring device and there is a risk that some external objects may occasionally interfere with the laser beam. In this case, the absolute positioning will work correctly when the external disturbance disappears. |

Parameter 17-78 Active Position Counter

Table 949: Parameter 17-78 Active Position Counter

| 17-78 Active Position Counter |                        |                                |
|-------------------------------|------------------------|--------------------------------|
| Default value: [0] Counter 0  | Parameter type: Option | Setup: All setups              |
| Conversion index: -           | Data type: Uint8       | Change during operation: False |

The drive has 4 individual position counters. Only the selected counter is updated. Allows tracking position of up to 4 motors controlled by 1 drive, 1 motor at a time. The active counter can be selected by this parameter in the same setup or by setup change when selecting between motors.



| Option | Name      | Description |
|--------|-----------|-------------|
| [0]*   | Counter 0 |             |
| [1]    | Counter 1 |             |
| [2]    | Counter 2 |             |
| [3]    | Counter 3 |             |

### 5.17.8 17-8\* Position Homing

Parameters for configuring the homing function. The homing function creates a position reference in the physical machine.

#### Parameter 17-80 Homing Function

Table 950: Parameter 17-80 Homing Function

| 17-80 Homing Function        |                        |                                |
|------------------------------|------------------------|--------------------------------|
| Default value: [0] No homing | Parameter type: Option | Setup: All setups              |
| Conversion index: -          | Data type: Uint8       | Change during operation: False |

## NOTICE

This parameter is only available with software version 48.XX.

Select the homing function. The homing function creates a position reference in the physical machine. The selected homing function can be activated with a digital input or a fieldbus bit. Homing is not required when using absolute encoders. All homing functions except [2] *Home Sync Function* require a start homing signal.

| Op-tion | Name                  | Description  |
|---------|-----------------------|--|
| [0]*    | No homing             | No homing function. The actual position is 0 after power-up, independent of the physical machine position.   |
| [1]     | Home position         | Actual position is set to the value of <i>parameter 17-82 Home Position</i> , index 0.   |
| [2]     | Home sync function    | Homing position is synchronized with the homing sensor according to the setting in <i>parameter 17-81 Home Sync Function</i> .   |
| [3]     | Analog input 53       | Use the value of analog input 53 as the actual position. The value is scaled according to <i>parameter 3-06 Minimum Position</i> and <i>parameter 3-07 Maximum Position</i> .  |
| [4]     | Analog input 54       | Same as [3] <i>Analog input 53</i> , but for analog input 54.  |
| [5]     | Home latch function   | Only latching of the actual position every time the home sensor is detected without executing any homing function. The result is updated in <i>parameter 18-25 latched Actual Pos</i> .  |
| [9]     | Direction with sensor | Perform a search for the homing sensor in the direction defined by the forward/reverse signal on a digital input or fieldbus, using the settings in <i>parameter 17-83 Homing Speed</i> and <i>parameter 17-84 Homing Torque Limit</i> . When the drive detects the homing sensor input (configured in <i>parameter group 5-1* Digital Inputs</i> ), it sets the actual position to the value of <i>parameter 17-82 Home Position</i> , index 0. The drive then switches to the positioning mode with a target defined in <i>parameter 17-82 Home Position</i> , index 0 + index 1. If reversing is required for going to the target position, set <i>parameter 4-10 Motor Speed Direction</i> to [2] <i>Both directions</i> . |
| [10]    | Forward with sensor   | Perform a search for the homing sensor in forward direction using the settings in <i>parameter 17-83 Homing Speed</i> and <i>parameter 17-84 Homing Torque Limit</i> . When the drive detects the homing sensor input (configured in <i>parameter group 5-1* Digital Inputs</i> ), it sets the actual position to the value of <i>parameter 17-82 Home Position</i> , index 0. The drive then switches to the positioning mode with a target defined in  |

| Option | Name                   | Description  |
|--------|------------------------|--|
|        |                        | <i>parameter 17-82 Home Position</i> , index 0 + index 1. If reversing is required for going to the target position, set <i>parameter 4-10 Motor Speed Direction</i> to [2] Both directions.   |
| [11]   | Reverse with sensor    | Same as [10] Forward with sensor, but with the search in the reverse direction. Set <i>parameter 4-10 Motor Speed Direction</i> to [1] Counter clockwise or [2] Both directions.   |
| [12]   | Forward torque limit   | With this option selected, the drive does the following: <ul style="list-style-type: none"> <li>Runs forward with the set homing speed (<i>parameter 17-83 Homing Speed</i>).</li> <li>When the torque reaches the limit set in <i>parameter 17-84 Homing Torque Limit</i>, and the speed is lower than the value in <i>parameter 3-05 On Reference Window</i>, the actual position is set to the value of <i>parameter 17-82 Home Position</i>, index 0.</li> <li>The drive positions to the target defined in <i>parameter 17-82 Home Position</i>, index 0 + index 1.</li> </ul> Only available in flux closed loop. See also <i>parameter 17-85 Homing Timeout</i> . |
| [13]   | Reverse torque limit   | Same as [12] Forward Torque Limit but in reverse direction. Set <i>parameter 4-10 Motor Speed Direction</i> to [1] Counter clockwise or [2] Both directions. Only available in flux closed loop.   |
| [14]   | Direction with Z pulse | Same as [9] Direction with Sensor but with encoder zero pulse as home sensor.  |
| [15]   | Forward with Z pulse   | Same as [10] Forward with Sensor but with encoder zero pulse as home sensor.   |
| [16]   | Reverse with Z pulse   | Same as [11] Reverse with Sensor but with encoder zero pulse as home sensor.   |
| [17]   | Direction with S & Z   | Same as [9] Direction with Sensor but moving to encoder zero pulse after finding the home sensor.  |
| [18]   | Forward with S & Z     | Same as [10] Forward with Sensor but moving to encoder zero pulse after finding the home sensor.   |
| [19]   | Reverse with S & Z     | Same as [11] Reverse with Sensor but moving to encoder zero pulse after finding the home sensor.   |
| [20]   | Fwd. II with sensor    | When on the correct side of the home sensor, performs a search for home sensor in forward direction using the settings in <i>parameter 17-83 Homing Speed</i> , and then reverses with 10% of Homing Speed when home sensor is detected. The falling edge of home sensor signal is set to the value defined in <i>parameter 17-82 Home Position</i> , index 0. When on the wrong side of the home sensor, the positive end limit switch is reached without detecting the home sensor, the drive reverses until home sensor is passed. After the home sensor is detected, the search for home sensor is performed in forward direction, as described.                     |
| [21]   | Rev. II with sensor    | When on the correct side of the home sensor, performs a search for home sensor in the reverse direction using the settings in <i>parameter 17-83 Homing Speed</i> , and then moves forward with 10% of Homing Speed when home sensor is detected. The falling edge of home sensor signal is set to the value defined in <i>parameter 17-82 Home Position</i> , index 0. When on the wrong side of the home sensor, a negative end limit switch is reached without detecting the home sensor, the drive operates in forward direction until home sensor is passed. After the home sensor is detected, the search for home sensor is performed in reverse, as described.   |

## Parameter 17-81 Home Sync Function

Table 951: Parameter 17-81 Home Sync Function

| 17-81 Home Sync Function                |                        |                                |
|---|------------------------|--------------------------------|
| Default value: [0] 1st time after power | Parameter type: Option | Setup: All setups              |
| Conversion index: -                     | Data type: Uint8       | Change during operation: False |

**NOTICE**

This parameter is only available with software version 48.XX.

Select the trigger for the homing synchronization function. Only active when [2] Home Sync Function is selected in parameter 17-80 Homing Function. The homing synchronization function sets the actual position to the value of parameter 17-82 Home Position:

- Index 0 if the homing sensor is approached in the forward direction.
- Index 1 if the homing sensor is approached in the reverse direction.

| Option | Name                    | Description  |
|--------|-------------------------|--|
| [0]*   | 1st time after power    | After power-up, the 1 <sup>st</sup> detection of the homing sensor triggers the function.                          |
| [1]    | 1st t. aft.pow. forward | After power-up, the 1 <sup>st</sup> detection of the homing sensor in the forward direction triggers the function. |
| [2]    | 1st t. aft.pow. reverse | After power-up, the 1 <sup>st</sup> detection of the homing sensor in the reverse direction triggers the function. |
| [3]    | 1st time after start    | After start, the 1 <sup>st</sup> detection of the homing sensor triggers the function.                             |
| [4]    | 1st t. aft.str. forward | After start, the 1 <sup>st</sup> detection of the homing sensor in the forward direction triggers the function.    |
| [5]    | 1st t. aft.str. reverse | After start, the 1 <sup>st</sup> detection of the homing sensor in the reverse direction triggers the function.    |
| [6]    | Every time              | Every detection of the homing sensor triggers the function.  |
| [7]    | Every time forward      | Every detection of the homing sensor in the forward direction triggers the function.                               |
| [8]    | Every time reverse      | Every detection of the homing sensor in the reverse direction triggers the function.                               |

Parameter 17-82 Home Position

Table 952: Parameter 17-82 Home Position

| 17-82 Home Position                   |   |                               |
|---------------------------------------|---|-------------------------------|
| Default value: 0 Custom- ReadoutUnit2 | Parameter type: Range, -2147483648 - 2147483647 CustomReadoutUnit2, Array [2] | Setup: All setups             |
| Conversion index: 0                   | Data type: Int32  | Change during operation: True |

**NOTICE**

This parameter is only available with software version 48.XX.

Set the homing position in position units defined in parameter group 17-7\* Position Scaling. This is an array parameter with 2 elements. Indices in this parameter have a different meaning in the following situations:

- If parameter 17-80 Homing Function is set to options [10]–[13], index 0 of this parameter defines the actual home position and index 1 is used as the homing offset, which defines where to stop.
- If parameter 17-80 Homing Function is set to [2] Home Sync Function, and parameter 17-81 Home Sync Function is set to [0] 1st time after power, [3] 1st time after start, or [6] Every time, then indices have the following meaning:
  - Index 0 is the homing position when the homing sensor is approached in the forward direction.
  - Index 1 is the homing position when the homing sensor is approached in the reverse direction.

## Parameter 17-83 Homing Speed

Table 953: Parameter 17-83 Homing Speed

| 17-83 Homing Speed     |   |                               |
|------------------------|---|-------------------------------|
| Default value: 150 RPM | Parameter type: Range, -32000 - 32000 RPM | Setup: All setups             |
| Conversion index: 67   | Data type: Int16                          | Change during operation: True |

## NOTICE

This parameter is only available with software version 48.XX.

Enter the speed for the homing functions (*parameter 17-80 Homing Function*, options [10]–[13]).

## Parameter 17-84 Homing Torque Limit

Table 954: Parameter 17-84 Homing Torque Limit

| 17-84 Homing Torque Limit |                                  |                               |
|---------------------------|----------------------------------|-------------------------------|
| Default value: 160%       | Parameter type: Range, -0 - 500% | Setup: All setups             |
| Conversion index: 0       | Data type: Uint16                | Change during operation: True |

## NOTICE

This parameter is only available with software version 48.XX.

Enter the torque limit for the homing functions (*parameter 17-80 Homing Function*, options [10]–[13]).

## Parameter 17-85 Homing Timeout

Table 955: Parameter 17-85 Homing Timeout

| 17-85 Homing Timeout  |  |                               |
|-----------------------|--|-------------------------------|
| Default value: 60.0 s | Parameter type: Range, -0.1 - 6000.0 s | Setup: All setups             |
| Conversion index: -1  | Data type: Uint16                      | Change during operation: True |

## NOTICE

This parameter is only available with software version 48.XX.

Enter the timeout for the homing functions (*parameter 17-80 Homing Function*, options [10]–[13]). If the drive does not detect the homing sensor or does not reach the torque limit within the timeout time, it aborts the homing process and trips.

## Parameter 17-86 Homing Flag Behavior

Table 956: Parameter 17-86 Homing Flag Behavior

| 17-86 Homing Flag Behavior           |                        |                                |
|--------------------------------------|------------------------|--------------------------------|
| Default value: [0] Clear at power-up | Parameter type: Option | Setup: All setups              |
| Conversion index: -                  | Data type: Uint8       | Change during operation: False |

## NOTICE

This parameter is only available with software version 48.XX.

Select when the Homing OK signal is cleared.

| Option | Name                   | Description  |
|--------|------------------------|--|
| [0]*   | Clear at power-up      | <i>Homing Ok</i> is cleared at power-up and a new homing is needed for subsequent positioning operations. The option is a typical selection when using incremental encoder and the position tracking is lost at power-down only.   |
| [1]    | Clear at coast         | <i>Homing Ok</i> is cleared at every motor coast and a new homing is needed. The option is a typical selection for sensorless control as position tracking is lost when motor is coasted.  |
| [2]    | Clear at coast running | <i>Homing Ok</i> is cleared at motor coast only while motor is running and a new homing is needed. The option is a typical selection for sensorless control with a mechanical brake holding the position at stand still.   |
| [3]    | Clear at homing only   | <i>Homing Ok</i> is only cleared at new start of the selected homing function. The option is a typical selection for absolute encoders. After completing the selected homing function <i>parameter 17-74 Position Offset</i> is automatically set to the offset calculated by: <i>Parameter 17-74 Position Offset</i> = ( <i>Parameter 17-82.0 Home Position</i> ) - (Position value read from encoder). Start a new homing to re-calculate <i>Parameter 17-74 Position Offset</i> , for example, after replacing the encoder. |

Parameter 17-87 Homing Activation

Table 957: Parameter 17-87 Homing Activation

| 17-87 Homing Activation   |                        |                                |
|---------------------------|------------------------|--------------------------------|
| Default value: [0] Manual | Parameter type: Option | Setup: All setups              |
| Conversion index: -       | Data type: Uint8       | Change during operation: False |

**NOTICE**

This parameter is only available with software version 48.XX.

Activation manner of drive homing and master homing. Master homing can be activated by a *Set Master Home* signal or the *Start Homing* signal by selecting options [2] *Manual and Master* and [3] *Auto and Master*.

| Option | Name              | Description  |
|--------|-------------------|--|
| [0]*   | Manual            | Activates homing function selected in <i>parameter 17-80 Homing Function</i> using the <i>Start Homing</i> signal.   |
| [1]    | Auto              | Homing function selected in <i>parameter 17-80 Homing Function</i> is activated automatically when the <i>Homing OK</i> signal is low and start signal is applied.   |
| [2]    | Manual and master | Activates homing function selected in <i>parameter 17-80 Homing Function</i> and sets the actual master position as defined in <i>parameter 17-88 Master Home Position</i> , using <i>Start Homing</i> signal.   |
| [3]    | Auto and master   | Homing function selected in <i>parameter 17-80 Homing Function</i> is activated automatically when the <i>Homing OK</i> signal is low and start signal is applied. The actual master position is set as defined in <i>parameter 17-88 Master Home Position</i> . |

Parameter 17-88 Master Home Position

Table 958: Parameter 17-88 Master Home Position

| 17-88 Master Home Position            |  |                               |
|---------------------------------------|--|-------------------------------|
| Default value: 0 Custom- ReadoutUnit2 | Parameter type: Range, -2147483648 - 2147483647 CustomReadoutUnit2 | Setup: All setups             |
| Conversion index: 0                   | Data type: Int32   | Change during operation: True |

## N O T I C E

This parameter is only available with software version 48.XX.

Set the master home position in position units which are used by master homing function.

### 5.17.9 17-9\* Position Configuration

#### Parameter 17-90 Absolute Position Mode

Table 959: Parameter 17-90 Absolute Position Mode

| 17-90 Absolute Position Mode |                        |                                |
|------------------------------|------------------------|--------------------------------|
| Default value: [0] Standard  | Parameter type: Option | Setup: All setups              |
| Conversion index: -          | Data type: Uint8       | Change during operation: False |

## N O T I C E

This parameter is only available with software version 48.XX.

Select the behavior when executing consecutive absolute positioning commands.

| Option | Name     | Description  |
|--------|----------|--|
| [0]*   | Standard | When the drive receives a new absolute positioning command while the previous command is still in progress, it executes the new positioning command immediately without completing the previous positioning.   |
| [1]    | Buffered | When the drive receives a new absolute positioning command while the previous positioning command is still in progress, it completes the previous command and then executes the new positioning command. Only 1 positioning command can be buffered at a time. |

#### Parameter 17-91 Relative Position Mode

Table 960: Parameter 17-91 Relative Position Mode

| 17-91 Relative Position Mode       |                        |                                |
|------------------------------------|------------------------|--------------------------------|
| Default value: [0] Target position | Parameter type: Option | Setup: All setups              |
| Conversion index: -                | Data type: Uint8       | Change during operation: False |

## N O T I C E

This parameter is only available with software version 48.XX.

Select which reference to use for relative positioning commands.

| Option | Name                 | Description   |
|--------|----------------------|---|
| [0]*   | Target position      | The drive uses the latest target position as reference for the new positioning command. The drive executes the new positioning command immediately without completing the previous positioning. The new target is calculated with the formula: $\text{New target} = \text{previous target} + \text{position reference}$ . |
| [1]    | Buffered target pos. | The drive uses the latest target position as reference for the new positioning command. The drive executes the new positioning command when it completes the previous command. Only 1 positioning command can be buffered at a time.  |
| [2]    | Commanded position   | The drive uses the commanded position as reference for the new positioning command. The drive executes the new positioning command immediately without completing the previous positioning. The new target is calculated with the formula: $\text{New target} = \text{commanded position} + \text{position reference}$ .  |
| [3]    | Actual position      | The drive uses the actual position as reference for the new positioning command. The drive executes the new positioning command immediately without completing the previous positioning. The new target is calculated with the formula: $\text{New target} = \text{actual position} + \text{position reference}$ .        |

Parameter 17-92 Position Control Selection

Table 961: Parameter 17-92 Position Control Selection

| 17-92 Position Control Selection |                        |                                |
|----------------------------------|------------------------|--------------------------------|
| Default value: [0] No operation  | Parameter type: Option | Setup: All setups              |
| Conversion index: -              | Data type: Uint8       | Change during operation: False |

**NOTICE**

This parameter is only available with software version 48.XX.

This parameter allows to select the position control mode without using a digital input signal or a fieldbus bit.

| Option | Name              | Description  |
|--------|-------------------|--|
| [0]*   | No operation      | Use a digital input signal or a fieldbus bit to activate the enable-reference mode and the relative position mode.   |
| [1]    | Relative position | This option selects the relative position mode permanently. All positioning commands are considered to be relative. Toggling option [113] <i>Enable Reference</i> on a digital input or the enable reference fieldbus bit triggers relative positioning. |
| [2]    | Enable reference  | This option selects the enable-reference mode permanently. Any new position reference triggers an absolute positioning command with the selected position reference as target. This option cannot be used with relative positioning.                     |

Parameter 17-93 Master Offset Selection

Table 962: Parameter 17-93 Master Offset Selection

| 17-93 Master Offset Selection       |                        |                                |
|-------------------------------------|------------------------|--------------------------------|
| Default value: [0] Absolute enabled | Parameter type: Option | Setup: All setups              |
| Conversion index: -                 | Data type: Uint8       | Change during operation: False |

**NOTICE**

This parameter is only available with software version 48.XX.

Select the behavior of the master offset in synchronization mode.

| Option | Name                  | Description  |
|--------|-----------------------|--|
| [0]*   | Absolute enabled      | The drive adds the master offset ( <i>parameter 3-26 Master Offset</i> ) to the position at synchronization start. The offset command is executed at every new synchronization start.                              |
| [1]    | Absolute              | The drive adds the master offset ( <i>parameter 3-26 Master Offset</i> ) to the position at synchronization start. The offset command is executed with every enable master offset signal.                          |
| [2]    | Relative              | The drive adds the master offset ( <i>parameter 3-26 Master Offset</i> ) to the actual synchronization position with every enable master offset signal.  |
| [3]    | Selection             | The master offset ( <i>parameter 3-26 Master Offset</i> ) is relative or absolute depending on the relative position signal on a digital input or the fieldbus bit.  |
| [4]    | Relative home sensor  | The master offset ( <i>parameter 3-26 Master Offset</i> ) is relative to the home sensor signal. The offset command is executed with the next home sensor signal when the enable master offset signal is active.   |
| [5]    | Relative touch sensor | The master offset ( <i>parameter 3-26 Master Offset</i> ) is relative to the touch sensor signal. The offset command is executed with the next touch sensor signal when the enable master offset signal is active. |

## Parameter 17-94 Rotary Absolute Direction

Table 963: Parameter 17-94 Rotary Absolute Direction

| 17-94 Rotary Absolute Direction |                        |                                |
|---------------------------------|------------------------|--------------------------------|
| Default value: [0] Shortest     | Parameter type: Option | Setup: All setups              |
| Conversion index: -             | Data type: Uint8       | Change during operation: False |

## N O T I C E

This parameter is only available with software version 48.XX.

Select the rotation direction for the absolute position mode when *parameter 17-76 Position Axis Mode* is set to [1] Rotary Axis. To use this parameter, set *parameter 4-10 Motor Speed Direction* to [2] Both directions.

| Option | Name      | Description   |
|--------|-----------|---|
| [0]*   | Shortest  | The drive selects the rotation direction that provides the shortest route to the target position. |
| [1]    | Forward   | Move to the target position in the forward direction.   |
| [2]    | Reverse   | Move to the target position in the reverse direction.   |
| [3]    | Direction | The forward/reverse signal on a digital input or fieldbus determines the rotation direction.      |

## Parameter 17-95 Offset Execution Distance

Table 964: Parameter 17-95 Offset Execution Distance

| 17-95 Offset Execution Distance |  |                               |
|---------------------------------|--|-------------------------------|
| Default value: 0                | Parameter type: Range, 0 - 2147483647 [pu] | Setup: All setups             |
| Conversion index: 0             | Data type: Int32                           | Change during operation: True |

## N O T I C E

This parameter is only available with software version 48.9X.



With the dynamic offset feature, it is possible to distribute execution of relative master offset and marker correction while synchronizing over a specific distance instead of using Ramp 1 (*parameter group 3-4\* Ramp 1*) and *parameter 3-28 Master Offset Speed Ref*. With this feature, an offset execution profile is calculated based on:

- Offset execution distance
- *Parameter 4-24 Max Speed*
- Actual master speed
- *Parameter 7-99 Min Ramp Time*

The offset execution distance can be related to the distance traveled by the master or the follower, selected in *parameter 17-96 Execution Distance Relation*. The execution distance relation is automatically extended if required due to speed/ramp limitation. This situation can be signaled in the fieldbus status word by selecting [22] *Execution distance extended* in *parameter 8-13 Configurable Status Word STW*.

Parameter 17-96 Execution Distance Relation

Table 965: Parameter 17-96 Execution Distance Relation

| 17-96 Execution Distance Relation |                        |                               |
|-----------------------------------|------------------------|-------------------------------|
| Default value: [0] Master related | Parameter type: Option | Setup: All setups             |
| Conversion index: -               | Data type: Uint8       | Change during operation: True |

**NOTICE**

This parameter is only available with software version 48.9X.

Select whether the value set in *parameter 17-95 Offset Execution Distance* is related to the distance traveled by the master or by the follower.

| Option | Name             | Description  |
|--------|------------------|--|
| [0]*   | Master related   | Offset execution is distributed over the offset execution distance traveled by the master.   |
| [1]    | Follower related | Offset execution is distributed over the offset execution distance traveled by the follower. |

## 5.18 Parameter Group 18-\*\* Data Readouts 2

### 5.18.1 18-0\* Maintenance Log

**NOTICE**

The following parameters are only available in FC 302:

- *Parameter 18-00 Maintenance Log: Item*
- *Parameter 18-01 Maintenance Log: Action*
- *Parameter 18-02 Maintenance Log: Time*
- *Parameter 18-03 Maintenance Log: Date and Time*

This group contains the last 10 preventive maintenance events. Maintenance log 0 is the latest and maintenance log 9 is the oldest. By selecting 1 of the logs and pressing [OK], the maintenance item, action, and time of the occurrence are shown in *parameter 18-00 Maintenance Log: Item* – *parameter 18-03 Maintenance Log: Date and Time*.

The alarm log key allows access to both alarm log and maintenance log.

## Parameter 18-00 Maintenance Log: Item

Table 966: Parameter 18-00 Maintenance Log: Item

| 18-00 Maintenance Log: Item |  |                                |
|-----------------------------|--|--------------------------------|
| Default value: 0            | Parameter type: Range, 0 - 255, Array [10] | Setup: All setups              |
| Conversion index: 0         | Data type: Uint8                           | Change during operation: False |

Shows the fault code. See the different maintenance items in *parameter 23-10 Maintenance Item*.

## Parameter 18-01 Maintenance Log: Action

Table 967: Parameter 18-01 Maintenance Log: Action

| 18-01 Maintenance Log: Action |  |                                |
|-------------------------------|--|--------------------------------|
| Default value: 0              | Parameter type: Range, 0 - 255, Array [10] | Setup: All setups              |
| Conversion index: 0           | Data type: Uint8                           | Change during operation: False |

Shows the fault code. See the different maintenance actions in *parameter 23-11 Maintenance Action*.

## Parameter 18-02 Maintenance Log: Time

Table 968: Parameter 18-02 Maintenance Log: Time

| 18-02 Maintenance Log: Time |   |                                |
|-----------------------------|---|--------------------------------|
| Default value: 0 s          | Parameter type: Range, 0 - 2147483647 s, Array [10] | Setup: All setups              |
| Conversion index: 0         | Data type: Uint32                                   | Change during operation: False |

Shows when the logged event occurred. Time is measured in s since last power-up.

## Parameter 18-03 Maintenance Log: Date and Time

Table 969: Parameter 18-03 Maintenance Log: Date and Time

| 18-03 Maintenance Log: Date and Time |  |                                |
|--------------------------------------|--|--------------------------------|
| Default value: Size related          | Parameter type: Range, 0 - 0, Array [10] | Setup: All setups              |
| Conversion index: 0                  | Data type: TimeOfDay                     | Change during operation: False |

Shows when the logged event occurred.

## N O T I C E

This requires that the date and time is programmed in *parameter 0-70 Date and Time*.

Date format depends on the setting in *parameter 0-71 Date Format*, while the time format depends on the setting in *parameter 0-72 Time Format*.

## N O T I C E

The drive has no back-up of the clock function. The set date/time resets to default (2000-01-01 00:00) after a power-down unless a real-time clock module with back-up is installed. In *parameter 0-79 Clock Fault*, it is possible to program a warning in case the clock has not been set properly, for example after a power-down. Incorrect setting of the clock affects the time stamps for the maintenance events.

## N O T I C E

When mounting a VLT® Analog I/O MCB 109 option card, a battery back-up of date and time is included.

## Parameter 18-04 Mech Brake Count

Table 970: Parameter 18-04 Mech Brake Count

| 18-04 Mech Brake Count |                                       |                                |
|------------------------|---------------------------------------|--------------------------------|
| Default value: 0       | Parameter type: Range, 0 - 4294967295 | Setup: All setups              |
| Conversion index: 0    | Data type: Uint32                     | Change during operation: False |

Number of occurrences the mechanical brake is engaged.

## 5.18.2 18-1\* Emergency Mode Log

The emergency log covers operation of emergency mode with start and stop activities and if critical alarms are suppressed during emergency mode. The log contains the 10 latest activations of emergency mode or the alarm number of the critical alarm that was suppressed as this affects the warranty of the drive. Suppressed alarm numbers are stored and can only be reset by a Danfoss service inspection.

## Parameter 18-10 Emergency Mode Log: Event

Table 971: Parameter 18-10 Emergency Mode Log: Event

| 18-10 Emergency Mode Log: Event |  |                                |
|---------------------------------|--|--------------------------------|
| Default value: 0                | Parameter type: Range, 0 - 255, Array [10] | Setup: All setups              |
| Conversion index: 0             | Data type: Uint8                           | Change during operation: False |

This parameter contains an array with 10 elements. The number read represents a fault code, which corresponds to a specific alarm. Refer to [7.1.2 Alarm/Warning Code List](#).

## Parameter 18-11 Emergency Mode Log: Time

Table 972: Parameter 18-11 Emergency Mode Log: Time

| 18-11 Emergency Mode Log: Time |   |                                |
|--------------------------------|---|--------------------------------|
| Default value: 0 s             | Parameter type: Range, 0 - 2147483647 s, Array [10] | Setup: All setups              |
| Conversion index: 0            | Data type: Uint32                                   | Change during operation: False |

This parameter shows at which time the logged event occurred. Time is measured in seconds since the drive was started.

## Parameter 18-12 Emergency Mode Log: Date and Time

Table 973: Parameter 18-12 Emergency Mode Log: Date and Time

| 18-12 Emergency Mode Log: Date and Time |   |                                |
|---|---|--------------------------------|
| Default value: Size related             | Parameter type: Range, Size related, Array [10] | Setup: All setups              |
| Conversion index: 0                     | Data type: TimeOfDay                            | Change during operation: False |

This parameter shows at which date and time the logged event occurred. The date and time rely on the internal clock in *parameter group 0-7\* Clock Settings*.

## 5.18.3 18-1\* Parameter Log

## Parameter 18-13 Parameter Number

Table 974: Parameter 18-13 Parameter Number

| 18-13 Parameter Number |   |                                |
|------------------------|---|--------------------------------|
| Default value: 0 N/A   | Parameter type: Range, 0 - 0xFFFF N/A, Array [10] | 4-setup: All set-ups           |
| Conversion index: 0    | Data type: Uint16                                 | Change during operation: False |

Shows the parameter which is most recently changed. Index 0 shows the latest change in the parameter.

## Parameter 18-14 Parameter Index

Table 975: Parameter 18-14 Parameter Index

| 18-14 Parameter Index |   |                                |
|-----------------------|---|--------------------------------|
| Default value: 0 N/A  | Parameter type: Range, 0 - 0xFFFF N/A, Array [10] | 4-setup: All set-ups           |
| Conversion index: -   | Data type: Uint16                                 | Change during operation: False |

This parameter shows the index of the parameter which was changed.

## Parameter 18-15 Change Time

Table 976: Parameter 18-15 Change Time

| 18-15 Change Time           |  |                                |
|-----------------------------|--|--------------------------------|
| Default value: Size related | Parameter type: Range, 0 - 0, Array [10] | 4-setup: All set-ups           |
| Conversion index: 0         | Data type: TimeOfDay                     | Change during operation: False |

Shows the date and time stamp when a parameter was most recently changed. It is recommended to set the time and date in the drive to ensure the right time is logged.

## Parameter 18-16 Operating Hours

Table 977: Parameter 18-16 Operating Hours

| 18-16 Operating Hours |   |                                |
|-----------------------|---|--------------------------------|
| Default value: 0      | Parameter type: Range, 0 - 2147483647, Array [10] | 4-setup: All set-ups           |
| Conversion index: 0   | Data type: Uint32                                 | Change during operation: False |

Shows operating hours of the drive at the instance when the parameter was changed.

## Parameter 18-17 Running Hours

Table 978: Parameter 18-17 Running Hours

| 18-17 Running Hours |   |                                |
|---------------------|---|--------------------------------|
| Default value: 0    | Parameter type: Range, 0 - 2147483647, Array [10] | 4-setup: All set-ups           |
| Conversion index: 0 | Data type: Uint32                                 | Change during operation: False |

Shows running hours of the motor when the parameter is changed.

## Parameter 18-18 Value Before Change as Integer

Table 979: Parameter 18-18 Value before change as Integer

| 18-18 Value before change as Integer |   |                                |
|--------------------------------------|---|--------------------------------|
| Default value: 0                     | Parameter type: Range, -2147483648 - 2147483647, Array [10] | 4-setup: All set-ups           |
| Conversion index: 0                  | Data type: Int32  | Change during operation: False |

Shows the previous value of the parameter as integer, without scaling or unit conversion. The parameter only shows integer data.

## Parameter 18-19 Value Before Change

Table 980: Parameter 18-19 Value Before Change

| 18-19 Value Before Change   |   |                                |
|-----------------------------|---|--------------------------------|
| Default value: Size related | Parameter type: Range, 0-30, Array [10] | 4-setup: All set-ups           |
| Conversion index: 0         | Data type: VisStr[30]                   | Change during operation: False |

Shows the previous value of the parameter with units. Only applicable for integer values.

### 5.18.4 18-2\* Motor Readouts

This parameter group contains more references and feedback readouts including Safe Option speeds.

#### Parameter 18-20 Commanded Position

**Table 981: Parameter 18-20 Commanded Position**

| 18-20 Commanded Position              |   |                               |
|---------------------------------------|---|-------------------------------|
| Default value: 0 Custom- ReadoutUnit2 | Parameter type: Range, -2147483648 - 2147483647<br>CustomReadoutUnit2 | Setup: All setups             |
| Conversion index: 0                   | Data type: Int32  | Change during operation: True |

### N O T I C E

This parameter is only available in software version 48.XX.

Shows the position reference for the position PI controller which is calculated every millisecond by the profile generator. Commanded position in position units as defined in *parameter group 17-0\* Position Scaling*.

#### Parameter 18-21 Master Position

**Table 982: Parameter 18-21 Master Position**

| 18-21 Master Position                 |   |                               |
|---------------------------------------|---|-------------------------------|
| Default value: 0 Custom- ReadoutUnit2 | Parameter type: Range, -2147483648 - 2147483647<br>CustomReadoutUnit2 | Setup: All setups             |
| Conversion index: 0                   | Data type: Int32  | Change during operation: True |

### N O T I C E

This parameter is only available in software version 48.XX.

Shows the actual master position based on the source selected in *parameter 3-16 Reference Resource 2*. Master position is converted to follower position units by the master scale set in *parameter 3-22 Master Scale Numerator* and *parameter 3-23 Master Scale Denominator*.

#### Parameter 18-23 Virtual Master Pos.

**Table 983: Parameter 18-23 Virtual Master Pos.**

| 18-23 Virtual Master Pos.             |   |                               |
|---------------------------------------|---|-------------------------------|
| Default value: 0 Custom- ReadoutUnit2 | Parameter type: Range, -2147483648 - 2147483647<br>CustomReadoutUnit2 | Setup: All setups             |
| Conversion index: 0                   | Data type: Int32  | Change during operation: True |

### N O T I C E

This parameter is only available in software version 48.XX.

Shows the current virtual master position which is calculated by the virtual master profile generator. Virtual master position in position units as defined in *parameter group 17-0\* Position Scaling*. Virtual master position is converted to follower position units by the master scale set in *parameter 3-22 Master Scale Numerator* and *parameter 3-23 Master Scale Denominator*.

## Parameter 18-24 Marker Pos. Offset

Table 984: Parameter 18-24 Marker Pos. Offset

| 18-24 Marker Pos. Offset |  |                               |
|--------------------------|--|-------------------------------|
| Default Value: 0         | Parameter Type: Range, -2147483648 - 2147483647 [pu] | Setup: All setups             |
| Conversion Index: 0      | Data Type: Int32                                     | Change during operation: True |

### N O T I C E

This parameter is only available in software version 48.8X.

Shows the position difference between master marker and follower marker in position units as defined in *parameter group 17-0\* Position Scaling*. The value is calculated by: Marker Pos. Offset = Master marker position – Follower marker position.

## Parameter 18-25 Latched Actual Pos.

Table 985: Parameter 18-25 Latched Actual Pos.

| 18-25 Latched Actual Pos. |  |                               |
|---------------------------|--|-------------------------------|
| Default value: 0          | Parameter type: Range, -2147483648 - 2147483647 [pu] | Setup: All setups             |
| Conversion index: 0       | Data type: Int32                                     | Change during operation: True |

### N O T I C E

This parameter is only available in software version 48.8X.

Shows the actual position latched by the latest detected sensor, that is home sensor, touch sensor, or follower marker.

## Parameter 18-26 Actual Velocity [pu/s]

Table 986: Parameter 18-26 Actual Velocity [pu/s]

| 18-26 Actual Velocity [pu/s] |  |                               |
|------------------------------|--|-------------------------------|
| Default value: 0             | Parameter type: Range, -2147483648 - 2147483647 [pu] | Setup: All setups             |
| Conversion index: 0          | Data type: Int32                                     | Change during operation: True |

### N O T I C E

This parameter is only available in software version 48.8X.

Shows the actual speed in position units per second.

## Parameter 18-27 Safe Opt. Speed

Table 987: Parameter 18-27 Safe Opt. Speed

| 18-27 Safe Opt. Speed |   |                               |
|-----------------------|---|-------------------------------|
| Default value: 0 RPM  | Parameter type: Range, -30000 - 30000 RPM | Setup: All setups             |
| Conversion index: 67  | Data type: Int32                          | Change during operation: True |

Shows the speed that the drive estimates and sends to the VLT® Safety Option MCB 15X.

## Parameter 18-28 Safe Opt. Meas. Speed

Table 988: Parameter 18-28 Safe Opt. Meas. Speed

| 18-28 Safe Opt. Meas. Speed |   |                               |
|-----------------------------|---|-------------------------------|
| Default value: 0 RPM        | Parameter type: Range, -30000 - 30000 RPM | Setup: All setups             |
| Conversion index: 67        | Data type: Int32                          | Change during operation: True |

Shows the speed measured by the VLT® Safety Option MCB 15X.

## Parameter 18-29 Safe Opt. Speed Error

Table 989: Parameter 18-29 Safe Opt. Speed Error

| 18-29 Safe Opt. Speed Error |   |                               |
|-----------------------------|---|-------------------------------|
| Default value: 0 RPM        | Parameter type: Range, -30000 - 30000 RPM | Setup: All setups             |
| Conversion index: 67        | Data type: Int32                          | Change during operation: True |

Shows the difference between the speed measured by the VLT® Safety Option MCB 15X and the speed estimated by the drive.

## 5.18.5 18-3\* Analog Input

Parameters in this group show data related to analog inputs.

## Parameter 18-36 Analog Input X48/2 [mA]

Table 990: Parameter 18-36 Analog Input X48/2 [mA]

| 18-36 Analog Input X48/2 [mA] |                                 |                               |
|-------------------------------|---------------------------------|-------------------------------|
| Default value: 0              | Parameter type: Range, -20 - 20 | Setup: All setups             |
| Conversion index: -3          | Data type: Int32                | Change during operation: True |

View the actual current measured at input X48/2.

## Parameter 18-37 Temp. Input X48/4

Table 991: Parameter 18-37 Temp. Input X48/4

| 18-37 Temp. Input X48/4 |                                   |                               |
|-------------------------|-----------------------------------|-------------------------------|
| Default value: 0        | Parameter type: Range, -500 - 500 | Setup: All set-ups            |
| Conversion index: 0     | Data type: Int16                  | Change during operation: True |

View the actual temperature measured at input X48/4. The temperature unit is based on the selection in *parameter 35-00 Term. X48/4 Temperature Unit*.

## Parameter 18-38 Temp. Input X48/7

Table 992: Parameter 18-38 Temp. Input X48/7

| 18-38 Temp. Input X48/7 |                                   |                               |
|-------------------------|-----------------------------------|-------------------------------|
| Default value: 0        | Parameter type: Range, -500 - 500 | Setup: All setups             |
| Conversion index: 0     | Data type: Int16                  | Change during operation: True |

View the actual temperature measured at input X48/7. The temperature unit is based on the selection in *parameter 35-02 Term. X48/7 Temperature Unit*.

## Parameter 18-39 Temp. Input X48/10

Table 993: Parameter 18-39 Temp. Input X48/10

| 18-39 Temp. Input X48/10 |                                   |                               |
|--------------------------|-----------------------------------|-------------------------------|
| Default value: 0         | Parameter type: Range, -500 - 500 | Setup: All setups             |
| Conversion index: 0      | Data type: Int16                  | Change during operation: True |

View the actual temperature measured at input X48/10. The temperature unit is based on the selection in *parameter 35-04 Term. X48/10 Temperature Unit*.

## 5.18.6 18-4\* PGIO Data Readouts

### N O T I C E

The following parameters are only available in FC 302

- *Parameter 18-40 Analog Input X49/1*
- *Parameter 18-41 Analog Input X49/3*
- *Parameter 18-42 Analog Input X49/5*
- *Parameter 18-46 X49 Digital Output [bin]*

Parameters for configuring the readout of VLT® Programmable I/O MCB 115.

## Parameter 18-40 Analog Input X49/1

Table 994: Parameter 18-40 Analog Input X49/1

| 18-40 Analog Input X49/1 |                                 |                                |
|--------------------------|---------------------------------|--------------------------------|
| Default value: 0         | Parameter type: Range, -20 - 20 | Setup: All setups              |
| Conversion index: -3     | Data type: Int32                | Change during operation: False |

View the actual value at input X49/1 either as a voltage, current or a temperature value.

## Parameter 18-41 Analog Input X49/3

Table 995: Parameter 18-41 Analog Input X49/3

| 18-41 Analog Input X49/3 |                                 |                                |
|--------------------------|---------------------------------|--------------------------------|
| Default value: 0         | Parameter type: Range, -20 - 20 | Setup: All setups              |
| Conversion index: -3     | Data type: Int32                | Change during operation: False |

View the actual value at input X49/3 either as a voltage, current, or a temperature value.

## Parameter 18-43 Analog Input X49/7

Table 996: Parameter 18-43 Analog Input X49/7

| 18-43 Analog Input X49/7 |                               |                                |
|--------------------------|-------------------------------|--------------------------------|
| Default value: 0         | Parameter type: Range, 0 - 30 | Setup: All setups              |
| Conversion index: -3     | Data type: Int16              | Change during operation: False |

Shows the actual value at output of terminal X49/7 in V or mA. The value reflects the selection in *parameter 36-40 Terminal X49/7 Analog Output*.



## Parameter 18-44 Analog Input X49/9

Table 997: Parameter 18-44 Analog Input X49/9

| 18-44 Analog Input X49/9 |                               |                                |
|--------------------------|-------------------------------|--------------------------------|
| Default value: 0         | Parameter type: Range, 0 - 30 | Setup: All setups              |
| Conversion index: -3     | Data type: Int16              | Change during operation: False |

Shows the actual value at output of terminal X49/9 in V or mA. The value reflects the selection in *parameter 36-50 Terminal X49/9 Analog Output*.

## Parameter 18-45 Analog Input X49/11

Table 998: Parameter 18-45 Analog Input X49/11

| 18-45 Analog Input X49/11 |                               |                                |
|---------------------------|-------------------------------|--------------------------------|
| Default value: 0          | Parameter type: Range, 0 - 30 | Setup: All setups              |
| Conversion index: -3      | Data type: Int16              | Change during operation: False |

Shows the actual value at output of terminal X49/11 in V or mA. The value reflects the selection in *parameter 36-60 Terminal X49/11 Analog Output*.

## Parameter 18-46 X49 Digital Output [bin]

Table 999: Parameter 18-46 X49 Digital Output [bin]

| 18-46 X49 Digital Output [bin] |                               |                                |
|--------------------------------|-------------------------------|--------------------------------|
| Default value: 0               | Parameter type: Range, 0 - 15 | Setup: All setups              |
| Conversion index: 0            | Data type: Int16              | Change during operation: False |

Shows the binary value of all programmable I/O digital outputs.

## 5.18.7 18-5\* Active Alarms/Warnings

The parameters in this group show the numbers of currently active alarms or warnings.

## Parameter 18-55 Active Alarm Numbers

Table 1000: Parameter 18-55 Active Alarm Numbers

| 18-55 Active Alarm Numbers |  |                               |
|----------------------------|--|-------------------------------|
| Default value: 0           | Parameter type: Range, 0 - 65535, Array [20] | Setup: All setups             |
| Conversion index: 0        | Data type: UInt16                            | Change during operation: True |

This parameter contains an array of up to 20 alarms that are currently active. The value 0 means no alarm.

## Parameter 18-56 Active Warning Numbers

Table 1001: Parameter 18-56 Active Warning Numbers

| 18-56 Active Warning Numbers |  |                               |
|------------------------------|--|-------------------------------|
| Default value: 0             | Parameter type: Range, 0 - 65535, Array [20] | Setup: All setups             |
| Conversion index: 0          | Data type: UInt16                            | Change during operation: True |

This parameter contains an array of up to 20 warnings that are currently active. The value 0 means no warning.

## 5.18.8 18-6\* Inputs & Outputs 2

### Parameter 18-60 Digital Input 2

Table 1002: Parameter 18-60 Digital Input 2

| 18-60 Digital Input 2 |                                  |                                |
|-----------------------|----------------------------------|--------------------------------|
| Default value: 0      | Parameter type: Range, 0 - 65535 | Setup: All setups              |
| Conversion index: 0   | Data type: Uint16                | Change during operation: False |

Shows the signal states from the active digital inputs.

- 0 = No signal
- 1 = Connected signal

## 5.18.9 18-7\* Rectifier Status

### NOTICE

This parameter group is only available in FC 302.

### Parameter 18-70 Mains Voltage

Table 1003: Parameter 18-70 Mains Voltage

| 18-70 Mains Voltage |                                   |                               |
|---------------------|-----------------------------------|-------------------------------|
| Default value: 0 V  | Parameter type: Range, 0 - 1000 V | Setup: All setups             |
| Conversion index: 0 | Data type: Uint16                 | Change during operation: True |

Shows the mains line-to-line voltage.

### Parameter 18-71 Mains Frequency

Table 1004: Parameter 18-71 Mains Frequency

| 18-71 Mains Frequency |                                      |                               |
|-----------------------|--------------------------------------|-------------------------------|
| Default value: 0 Hz   | Parameter type: Range, -100 - 100 Hz | Setup: All setups             |
| Conversion index: -1  | Data type: Int16                     | Change during operation: True |

Shows the mains frequency.

### Parameter 18-72 Mains Imbalance

Table 1005: Parameter 18-72 Mains Imbalance

| 18-72 Mains Imbalance |                                 |                               |
|-----------------------|---------------------------------|-------------------------------|
| Default value: 0%     | Parameter type: Range, 0 - 100% | Setup: All setups             |
| Conversion index: -1  | Data type: Uint16               | Change during operation: True |

Shows the maximum imbalance for the 3 mains line-to-line measurements.

### Parameter 18-73 Worst Inrush

Table 1006: Parameter 18-73 Worst Inrush

| 18-73 Worst Inrush  |                                  |                               |
|---------------------|----------------------------------|-------------------------------|
| Default value: 0    | Parameter type: Range, 0 - 10000 | Setup: All setups             |
| Conversion index: 0 | Data type: Uint16                | Change during operation: True |

This parameter identifies which active inrush produces the data shown in *parameter 18-70 Mains Voltage*, *parameter 18-71 Mains Frequency*, *parameter 18-72 Mains Imbalance*, and *parameter 18-75 Rectifier DC Volt*. 1 = inrush 1, 2 = inrush 2, and so on.  
Parameter 18-74 Inrush Mode

Table 1007: Parameter 18-74 Inrush Mode

| 18-74 Inrush Mode   |  |                               |
|---------------------|--|-------------------------------|
| Default value: 0    | Parameter type: Range, 0 - 1000, Array [4] | Setup: All setups             |
| Conversion index: 0 | Data type: Uint16                          | Change during operation: True |

This parameter shows the reported mode of each inrush board. The values are:

- 0 = unknown
- 1 = inrush
- 2 = running

The indices are as follows:

- 0 = inrush1
- 1 = inrush2
- 2 = inrush3
- 3 = inrush4

#### Parameter 18-75 Rectifier DC Volt

Table 1008: Parameter 18-75 Rectifier DC Volt

| 18-75 Rectifier DC Volt |                                    |                               |
|-------------------------|------------------------------------|-------------------------------|
| Default value: 0 V      | Parameter type: Range, 0 - 10000 V | Setup: All setups             |
| Conversion index: 0     | Data type: Uint16                  | Change during operation: True |

Shows the DC voltage measured on the rectifier module.

#### Parameter 18-76 Mains Voltage 2

Table 1009: Parameter 18-76 Mains Voltage 2

| 18-76 Mains Voltage 2 |   |                               |
|-----------------------|---|-------------------------------|
| Default value: 0 V    | Parameter type: Range, 0 - 1000 V, Array [16] | Setup: All setups             |
| Conversion index: 0   | Data type: Uint16                             | Change during operation: True |

View the mains line-to-line measurements. The values are RMS. The indices are as follows:

- 0 = inrush1 average
- 1 = inrush2 average
- 4 = inrush1 L1
- 5 = inrush2 L1
- 8 = inrush1 L2
- 9 = inrush2 L2
- = inrush1 L3
- = inrush2 L3

## Parameter 18-77 Mains Frequency 2

Table 1010: Parameter 18-77 Mains Frequency 2

| 18-77 Mains Frequency 2 |   |                               |
|-------------------------|---|-------------------------------|
| Default value: 0 Hz     | Parameter type: Range, -100 - 100 Hz, Array [4] | Setup: All setups             |
| Conversion index: 0     | Data type: Uint16                               | Change during operation: True |

View the mains frequency measurement. The indices are as follows:

- 0 = inrush1
- 1 = inrush2

## Parameter 18-78 Mains Imbalance 2

Table 1011: Parameter 18-78 Mains Imbalance 2

| 18-78 Mains Imbalance 2 |  |                               |
|-------------------------|--|-------------------------------|
| Default value: 0%       | Parameter type: Range, 0 - 100%, Array [4] | Setup: All setups             |
| Conversion index: 0     | Data type: Uint16                          | Change during operation: True |

View the maximum measured imbalance for the 3 mains line-to-line measurements. The indices are as follows:

- 0 = inrush1
- 1 = inrush2

## Parameter 18-79 Rectifier DC Volt. 2

Table 1012: Parameter 18-79 Rectifier DC Volt. 2

| 18-79 Rectifier DC Volt. 2 |                                   |                               |
|----------------------------|-----------------------------------|-------------------------------|
| Default value: 0 V         | Parameter type: Range, 0 - 1000 V | Setup: All setups             |
| Conversion index: 0        | Data type: Uint16                 | Change during operation: True |

View the DC voltage measurement from the rectifier module. The indices are as follows:

- 0 = inrush1
- 1 = inrush2
- Parameter 18-89 Mode of Operation Display
- 

Table 1013: Parameter 18-89 Mode of Operation Display

| 18-89 Mode of Operation Display   |                        |                               |
|-----------------------------------|------------------------|-------------------------------|
| Default value: [0] No mode change | Parameter type: Option | Setup: All setups             |
| Conversion index: -               | Data type: Uint8       | Change during operation: True |

## N O T I C E

This parameter is only available with software version 48.XX.

Shows the active mode of operation which is selected in *parameter 1-09 Mode of Operation*.

| Option | Name                  | Description |
|--------|-----------------------|-------------|
| [0]*   | No mode change        |             |
| [1]    | Profile position mode |             |
| [2]    | Velocity mode (vl)    |             |

| Option | Name                      | Description |
|--------|---------------------------|-------------|
| [6]    | Homing mode               |             |
| [8]    | Cyclic sync position mode |             |
| [9]    | Cyclic sync velocity mode |             |
| [249]  | Gear mode                 |             |
| [250]  | Cam mode                  |             |

### 5.18.10 18-9\* PID Readouts

#### Parameter 18-90 Process PID Error

Table 1014: Parameter 18-90 Process PID Error

| 18-90 Process PID Error |                                    |                                |
|-------------------------|------------------------------------|--------------------------------|
| Default value: 0%       | Parameter type: Range, -200 - 200% | Setup: All setups              |
| Conversion index: -1    | Data type: Int16                   | Change during operation: False |

Gives the present error value used by the process PID controller.

#### Parameter 18-91 Process PID Output

Table 1015: Parameter 18-91 Process PID Output

| 18-91 Process PID Output |                                    |                                |
|--------------------------|------------------------------------|--------------------------------|
| Default value: 0%        | Parameter type: Range, -200 - 200% | Setup: All setups              |
| Conversion index: -1     | Data type: Int16                   | Change during operation: False |

Gives the present raw output value from the process PID controller.

#### Parameter 18-92 Process PID Clamped Output

Table 1016: Parameter 18-92 Process PID Clamped Output

| 18-92 Process PID Clamped Output |                                    |                                |
|----------------------------------|------------------------------------|--------------------------------|
| Default value: 0%                | Parameter type: Range, -200 - 200% | Setup: All setups              |
| Conversion index: -1             | Data type: Int16                   | Change during operation: False |

Gives the present output value from the process PID controller after the clamp limits have been observed.

#### Parameter 18-93 Process PID Gain Scaled Output

Table 1017: Parameter 18-93 Process PID Gain Scaled Output

| 18-93 Process PID Gain Scaled Output |                                    |                                |
|--------------------------------------|------------------------------------|--------------------------------|
| Default value: 0%                    | Parameter type: Range, -200 - 200% | Setup: All setups              |
| Conversion index: -1                 | Data type: Int16                   | Change during operation: False |

Gives the present output value from the process PID controller after the clamp limits have been observed, and the resulting value has been gain scaled.

Parameter 18-99 Speed Torque FF. [Nm]

Table 1018: Parameter 18-99 Speed Torque FF. [Nm]

| 18-99 Speed Torque FF. [Nm] |  |                               |
|-----------------------------|--|-------------------------------|
| Default value: 0 Nm         | Parameter type: Range, -200000000 - 200000000 Nm | Setup: All setups             |
| Conversion index: 0         | Data type: Int32                                 | Change during operation: True |

Readout of the total command torque feed forward [Nm]. The parameter shows the sum of *parameter 16-88 Fieldbus Torque FF* and *parameter 1-69 Maximum Inertia x parameter 7-08 Speed PID Feed Forward Factor*.

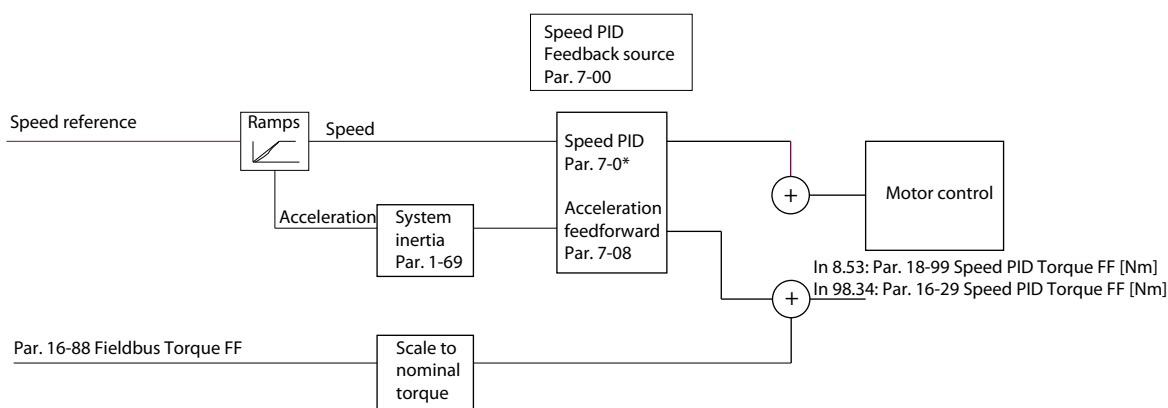

### 5.19 Parameter Group 19-\*\* Application Parameters

Parameters in this group are available when VLT® Motion Control Option MCO 305 is installed in the drive. For more information about the option, see the VLT® Motion Control Option MCO 305 Operating Instructions.

### 5.20 Parameter Group 22-\*\* Appl. Functions

Parameter group for application monitoring functions.

#### 5.20.1 22-0\* Miscellaneous

##### Parameter 22-00 External Interlock Delay

Table 1019: Parameter 22-00 External Interlock Delay

| 22-00 External Interlock Delay |                                  |                               |
|--------------------------------|----------------------------------|-------------------------------|
| Default value: 0 s             | Parameter type: Range, 0 - 600 s | Setup: All setups             |
| Conversion index: 0            | Data type: Uint16                | Change during operation: True |

Set the delay time for the external interlock command.

##### Parameter 22-03 Start Command Delay

Table 1020: Parameter 22-03 Start Command Delay

| 22-03 Start Command Delay |                                  |                               |
|---------------------------|----------------------------------|-------------------------------|
| Default value: 0 ms       | Parameter type: Range, 0 -100 ms | Setup: All setups             |
| Conversion index: 0       | Data type: Uint16                | Change during operation: True |

This parameter is suited for lift applications and can be set to suppress contact bounce or delay the start command. Start will only be activated when the signal has been stable for the time set in this parameter. The function is active on digital input, FC port, and fieldbus options.

## 5.21 Parameter Group 23-\*\* Time-based Functions

### 5.21.1 23-0\* Timed Actions

#### NOTICE

This parameter group is only available in FC 302.

Use timed actions for actions performed on a daily or weekly basis, for example different references for working hours/non-working hours. Up to 10 timed actions can be programmed in the drive. Select the timed action number from the list when entering *parameter group 23-\*\* Time-based Functions* from the LCP. *Parameter 23-00 ON Time* and *parameter 23-04 Occurrence* then refer to the selected timed action number. Each timed action is divided into an ON time and an OFF time, in which 2 different actions may be performed.

Display lines 2 and 3 in the LCP show the status for timed actions mode (*parameter 0-23 Display Line 2 Large* and *parameter 0-24 Display Line 3 Large*, setting [1643] *Timed Actions Status*).

#### NOTICE

A change in mode via the digital inputs can only take place if *parameter 23-08 Timed Actions Mode* is set to [0] *Times Actions Auto*. If commands are applied simultaneously to the digital inputs for constant OFF and constant ON, the timed actions mode changes to timed actions auto and the 2 commands are disregarded. If *parameter 0-70 Date and Time* is not set or the drive is set to hand-on mode or OFF mode (for example via the LCP), the timed actions mode is changed to [0] *Disabled*. The timed actions have a higher priority than the same actions/commands activated by the digital inputs or the smart logic controller.

The actions programmed in timed actions are merged with corresponding actions from digital inputs, control word via bus, and smart logic controller, according to merge rules set up in *parameter group 8-5\* Digital/Bus*.

#### NOTICE

Program the clock (*parameter group 0-7\* Clock Settings*) correctly for timed actions to function.

#### NOTICE

The PC-based configuration tool VLT® Motion Control Tool MCT 10 comprises a special guide for easy programming of timed actions.

### Parameter 23-00 ON Time

Table 1021: Parameter 23-00 ON Time

| 23-00 ON Time               |  |                               |
|-----------------------------|--|-------------------------------|
| Default value: Size related | Parameter type: Range, 0 - 0, Array [10] | Setup: 2 setups               |
| Conversion index: 0         | Data type: TimeOfDayWoDate               | Change during operation: True |

Sets the ON time for the desired action.

#### NOTICE

The drive has no back-up of the clock function. The set date/time resets to default (2000-01-01 00:00) after a power-down unless a real-time clockmodule with back-up is installed. In *parameter 0-79 Clock Fault*, it is possible to program a warning if the clock has not been set properly, for example after a power-down.

## Parameter 23-01 ON Action

Table 1022: Parameter 23-01 ON Action

| 23-01 ON Action             |                                    |                               |
|-----------------------------|------------------------------------|-------------------------------|
| Default value: [0] Disabled | Parameter type: Option, Array [10] | Setup: 2 setups               |
| Conversion index: -         | Data type: Uint8                   | Change during operation: True |

## N O T I C E

For options [32] Set digital out A low–[43] Set digital out F high, see also parameter group 5-3\* Digital Outputs and parameter group 5-4\* Relays.

Select the action during ON time. See parameter 13-52 SL Controller Action for descriptions of the options.

| Option | Name                | Description |
|--------|---------------------|-------------|
| [0]*   | Disabled            |             |
| [1]    | No action           |             |
| [2]    | Select set-up 1     |             |
| [3]    | Select set-up 2     |             |
| [4]    | Select set-up 3     |             |
| [5]    | Select set-up 4     |             |
| [10]   | Select preset ref 0 |             |
| [11]   | Select preset ref 1 |             |
| [12]   | Select preset ref 2 |             |
| [13]   | Select preset ref 3 |             |
| [14]   | Select preset ref 4 |             |
| [15]   | Select preset ref 5 |             |
| [16]   | Select preset ref 6 |             |
| [17]   | Select preset ref 7 |             |
| [18]   | Select ramp 1       |             |
| [19]   | Select ramp 2       |             |
| [20]   | Select ramp 3       |             |
| [21]   | Select ramp 4       |             |
| [22]   | Run                 |             |
| [23]   | Run reverse         |             |
| [24]   | Stop                |             |
| [25]   | Qstop               |             |
| [26]   | Dcstop              |             |
| [27]   | Coast               |             |



| Option | Name                   | Description |
|--------|------------------------|-------------|
| [32]   | Set digital out A low  |             |
| [33]   | Set digital out B low  |             |
| [34]   | Set digital out C low  |             |
| [35]   | Set digital out D low  |             |
| [36]   | Set digital out E low  |             |
| [37]   | Set digital out F low  |             |
| [38]   | Set digital out A high |             |
| [39]   | Set digital out B high |             |
| [40]   | Set digital out C high |             |
| [41]   | Set digital out D high |             |
| [42]   | Set digital out E high |             |
| [43]   | Set digital out F high |             |
| [60]   | Reset counter A        |             |
| [61]   | Reset counter B        |             |
| [62]   | Counter A (up)         |             |
| [63]   | Counter A (down)       |             |
| [64]   | Counter B (up)         |             |
| [65]   | Counter B (down)       |             |

## Parameter 23-02 OFF Time

Table 1023: Parameter 23-02 OFF Time

| 23-02 OFF Time              |  |                               |
|-----------------------------|--|-------------------------------|
| Default value: Size related | Parameter type: Range, 0 - 0, Array [10] | Setup: 2 setups               |
| Conversion index: 0         | Data type: TimeOfDayWoDate               | Change during operation: True |

Sets the OFF time for the desired action.

## NOTICE

The drive has no back-up of the clock function. The set date/time resets to default (2000-01-01 00:00) after a power-down unless a real-time clockmodule with back-up is installed. In *parameter 0-79 Clock Fault*, it is possible to program a warning if the clock has not been set properly, for example after a power-down.

## Parameter 23-03 OFF Action

Table 1024: Parameter 23-03 OFF Action

| 23-03 OFF Action             |                                    |                               |
|------------------------------|------------------------------------|-------------------------------|
| Default value: [1] No action | Parameter type: Option, Array [10] | Setup: 2 setups               |
| Conversion index: -          | Data type: Uint8                   | Change during operation: True |

Select the action during OFF time. See *parameter 13-52 SL Controller Action* for descriptions of the options.

| Option | Name                   | Description |
|--------|------------------------|-------------|
| [1]*   | No action              |             |
| [2]    | Select set-up 1        |             |
| [3]    | Select set-up 2        |             |
| [4]    | Select set-up 3        |             |
| [5]    | Select set-up 4        |             |
| [10]   | Select preset ref 0    |             |
| [11]   | Select preset ref 1    |             |
| [12]   | Select preset ref 2    |             |
| [13]   | Select preset ref 3    |             |
| [14]   | Select preset ref 4    |             |
| [15]   | Select preset ref 5    |             |
| [16]   | Select preset ref 6    |             |
| [17]   | Select preset ref 7    |             |
| [18]   | Select ramp 1          |             |
| [19]   | Select ramp 2          |             |
| [20]   | Select ramp 3          |             |
| [21]   | Select ramp 4          |             |
| [22]   | Run                    |             |
| [23]   | Run reverse            |             |
| [24]   | Stop                   |             |
| [25]   | Qstop                  |             |
| [26]   | Dcstop                 |             |
| [27]   | Coast                  |             |
| [32]   | Set digital out A low  |             |
| [33]   | Set digital out B low  |             |
| [34]   | Set digital out C low  |             |
| [35]   | Set digital out D low  |             |
| [36]   | Set digital out E low  |             |
| [37]   | Set digital out F low  |             |
| [38]   | Set digital out A high |             |
| [39]   | Set digital out B high |             |
| [40]   | Set digital out C high |             |

| Option | Name                   | Description |
|--------|------------------------|-------------|
| [41]   | Set digital out D high |             |
| [42]   | Set digital out E high |             |
| [43]   | Set digital out F high |             |
| [60]   | Reset counter A        |             |
| [61]   | Reset counter B        |             |
| [62]   | Counter A (up)         |             |
| [63]   | Counter A (down)       |             |
| [64]   | Counter B (up)         |             |
| [65]   | Counter B (down)       |             |

## Parameter 23-04 Occurrence

Table 1025: Parameter 23-04 Occurrence

| 23-04 Occurrence            |                                    |                               |
|-----------------------------|------------------------------------|-------------------------------|
| Default value: [0] All days | Parameter type: Option, Array [10] | Setup: 2 setups               |
| Conversion index: -         | Data type: Uint8                   | Change during operation: True |

Select which days the timed action applies to. Specify working/nonworking days in:

- *Parameter 0-81 Working Days.*
- *Parameter 0-82 Additional Working Days.*
- *Parameter 0-83 Additional Non-Working Days.*

| Option | Name             | Description |
|--------|------------------|-------------|
| [0]*   | All days         |             |
| [1]    | Working days     |             |
| [2]    | Non-working days |             |
| [3]    | Monday           |             |
| [4]    | Tuesday          |             |
| [5]    | Wednesday        |             |
| [6]    | Thursday         |             |
| [7]    | Friday           |             |
| [8]    | Saturday         |             |
| [9]    | Sunday           |             |
| [10]   | Day 1 of month   |             |
| [11]   | Day 2 of month   |             |
| [12]   | Day 3 of month   |             |
| [13]   | Day 4 of month   |             |

| Option | Name            | Description |
|--------|-----------------|-------------|
| [14]   | Day 5 of month  |             |
| [15]   | Day 6 of month  |             |
| [16]   | Day 7 of month  |             |
| [17]   | Day 8 of month  |             |
| [18]   | Day 9 of month  |             |
| [19]   | Day 10 of month |             |
| [20]   | Day 11 of month |             |
| [21]   | Day 12 of month |             |
| [22]   | Day 13 of month |             |
| [23]   | Day 14 of month |             |
| [24]   | Day 15 of month |             |
| [25]   | Day 16 of month |             |
| [26]   | Day 17 of month |             |
| [27]   | Day 18 of month |             |
| [28]   | Day 19 of month |             |
| [29]   | Day 20 of month |             |
| [30]   | Day 21 of month |             |
| [31]   | Day 22 of month |             |
| [32]   | Day 23 of month |             |
| [33]   | Day 24 of month |             |
| [34]   | Day 25 of month |             |
| [35]   | Day 26 of month |             |
| [36]   | Day 27 of month |             |
| [37]   | Day 28 of month |             |
| [38]   | Day 29 of month |             |
| [39]   | Day 30 of month |             |
| [40]   | Day 31 of month |             |

Parameter 23-08 Timed Actions Mode

Table 1026: Parameter 23-08 Timed Actions Mode

| 23-08 Timed Actions Mode              |                        |                               |
|---------------------------------------|------------------------|-------------------------------|
| Default value: [0] Timed actions auto | Parameter type: Option | Setup: 2 setups               |
| Conversion index: -                   | Data type: Uint8       | Change during operation: True |

Enable and disable automatic timed actions.

| Option | Name                   | Description  |
|--------|------------------------|--|
| [0]*   | Timed actions auto     | Enable timed actions.  |
| [1]    | Timed actions disabled | Disable timed actions, normal operation according to control commands. |
| [2]    | Constant on actions    | Disable timed actions. Constant on actions are activated.              |
| [3]    | Constant off actions   | Disable timed actions. Constant off actions are activated.             |

Parameter 23-09 Timed Actions Reactivation

Table 1027: Parameter 23-09 Timed Actions Reactivation

| 23-09 Timed Actions Reactivation |                        |                               |
|----------------------------------|------------------------|-------------------------------|
| Default value: [1] Enabled       | Parameter type: Option | Setup: 2 setups               |
| Conversion index: -              | Data type: Uint8       | Change during operation: True |

| Option | Name     | Description   |
|--------|----------|---|
| [0]    | Disabled | After an update of: <ul style="list-style-type: none"> <li>power cycling</li> <li>setting date</li> <li>time</li> <li>change of summertime</li> <li>change of Hand Auto mode</li> <li>change of Constant On and Off</li> <li>setup change where all activated ON actions are overridden to OFF actions until passing the next time for an ON action. Any OFF actions remain unchanged.</li> </ul> |
| [1]*   | Enabled  | After an update of time/condition On and OFF actions are immediately set to the actual time programming of ON and OFF actions.  |

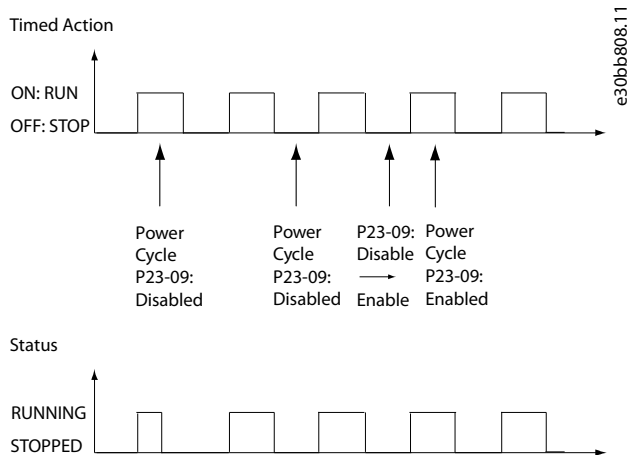

Illustration 94: Example of Reactivation Test

### 5.21.2 23-1\* Maintenance

Wear and tear calls for periodic inspection and service of elements in the application, for example motor bearings, feedback sensors, seals, and filters. With preventive maintenance, the service intervals may be programmed into the drive. The drive gives a message when maintenance is required. 20 preventive maintenance events can be programmed into the drive.

Specify the following for each event:

- Maintenance item (for example, motor bearings).
- Maintenance action (for example, replacement).
- Maintenance time base (for example, running hours, or a specific date and time).
- Maintenance time interval or the date and time of next maintenance.

## N O T I C E

To disable a preventive maintenance event, set the associated *parameter 23-12 Maintenance Base* to [0] Disabled.

Preventive maintenance can be programmed from the LCP, but use of the PC-based VLT® Motion Control Tool MCT 10 is recommended.

| ID      | Name               | Setup 1        | Setup 2        | Setup 3        | Setup 4        |
|---------|--------------------|----------------|----------------|----------------|----------------|
| 2310.0  | Maintenance Item   | Motor bearings | Motor bearings | Motor bearings | Motor bearings |
| 2310.1  | Maintenance Item   | Motor bearings | Motor bearings | Motor bearings | Motor bearings |
| 2310.2  | Maintenance Item   | Motor bearings | Motor bearings | Motor bearings | Motor bearings |
| 2310.3  | Maintenance Item   | Motor bearings | Motor bearings | Motor bearings | Motor bearings |
| 2310.4  | Maintenance Item   | Motor bearings | Motor bearings | Motor bearings | Motor bearings |
| 2310.5  | Maintenance Item   | Motor bearings | Motor bearings | Motor bearings | Motor bearings |
| 2310.6  | Maintenance Item   | Motor bearings | Motor bearings | Motor bearings | Motor bearings |
| 2310.7  | Maintenance Item   | Motor bearings | Motor bearings | Motor bearings | Motor bearings |
| 2310.8  | Maintenance Item   | Motor bearings | Motor bearings | Motor bearings | Motor bearings |
| 2310.9  | Maintenance Item   | Motor bearings | Motor bearings | Motor bearings | Motor bearings |
| 2310.10 | Maintenance Item   | Motor bearings | Motor bearings | Motor bearings | Motor bearings |
| 2310.11 | Maintenance Item   | Motor bearings | Motor bearings | Motor bearings | Motor bearings |
| 2310.12 | Maintenance Item   | Motor bearings | Motor bearings | Motor bearings | Motor bearings |
| 2310.13 | Maintenance Item   | Motor bearings | Motor bearings | Motor bearings | Motor bearings |
| 2310.14 | Maintenance Item   | Motor bearings | Motor bearings | Motor bearings | Motor bearings |
| 2310.15 | Maintenance Item   | Motor bearings | Motor bearings | Motor bearings | Motor bearings |
| 2310.16 | Maintenance Item   | Motor bearings | Motor bearings | Motor bearings | Motor bearings |
| 2310.17 | Maintenance Item   | Motor bearings | Motor bearings | Motor bearings | Motor bearings |
| 2310.18 | Maintenance Item   | Motor bearings | Motor bearings | Motor bearings | Motor bearings |
| 2310.19 | Maintenance Item   | Motor bearings | Motor bearings | Motor bearings | Motor bearings |
| 2311.0  | Maintenance Action | Lubricate      | Lubricate      | Lubricates     | Lubricate      |
| 2311.2  | Maintenance Action | Lubricate      | Lubricate      | Lubricates     | Lubricate      |
| 2311.3  | Maintenance Action | Lubricate      | Lubricate      | Lubricates     | Lubricate      |
| 2311.4  | Maintenance Action | Lubricate      | Lubricate      | Lubricates     | Lubricate      |
| 2311.5  | Maintenance Action | Lubricate      | Lubricate      | Lubricates     | Lubricate      |
| 2311.6  | Maintenance Action | Lubricate      | Lubricate      | Lubricates     | Lubricate      |

Illustration 95: Maintenance Menu, MCT 10

The LCP indicates (with a wrench icon and letter M) when it is time for a preventive maintenance action and can be programmed to be indicated on a digital output in *parameter group 5-3\* Digital Outputs*. The preventive maintenance status is shown in *parameter 16-96 Maintenance Word*. A preventive maintenance indication can be reset from a digital input, the FC bus, or manually from the LCP through *parameter 23-15 Reset Maintenance Word*.

## N O T I C E

The preventive maintenance events are defined in a 20-element array. Hence, each preventive maintenance event must use the same array element index in *parameter 23-10 Maintenance Item* to *parameter 23-14 Maintenance Date and Time*.

### Parameter 23-10 Maintenance Item

Table 1028: Parameter 23-10 Maintenance Item

| 23-10 Maintenance Item            |                                   |                               |
|-----------------------------------|-----------------------------------|-------------------------------|
| Default value: [1] Motor Bearings | Parameter type: Option, Array [6] | Setup: 1 setup                |
| Conversion index: -               | Data type: Uint8                  | Change during operation: True |

Array with 20 elements shown below the parameter number in the display. Press [OK] and step between elements with [◀], [▶], [▲], and [▼]. Select the item to be associated with the preventive maintenance event.

| Option | Name                | Description |
|--------|---------------------|-------------|
| [1]*   | Motor bearings      |             |
| [11]   | Drive cooling fan   |             |
| [12]   | System health check |             |
| [13]   | Warranty            |             |
| [14]   | Mech brake          |             |
| [20]   | Maintenance text 0  |             |
| [21]   | Maintenance text 1  |             |
| [22]   | Maintenance text 2  |             |
| [23]   | Maintenance text 3  |             |
| [24]   | Maintenance text 4  |             |
| [25]   | Maintenance text 5  |             |
| [26]   | Service log full    |             |

Parameter 23-11 Maintenance Action

Table 1029: Parameter 23-11 Maintenance Action

| 23-11 Maintenance Action     |                                   |                               |
|------------------------------|-----------------------------------|-------------------------------|
| Default value: [1] Lubricate | Parameter type: Option, Array [6] | Setup: 1 setup                |
| Conversion index: -          | Data type: Uint8                  | Change during operation: True |

Select the action to be associated with the preventive maintenance event.

| Option | Name               | Description |
|--------|--------------------|-------------|
| [1]*   | Lubricate          |             |
| [2]    | Clean              |             |
| [3]    | Replace            |             |
| [4]    | Inspect/check      |             |
| [5]    | Overhaul           |             |
| [6]    | Renew              |             |
| [7]    | Check              |             |
| [20]   | Maintenance text 0 |             |
| [21]   | Maintenance text 1 |             |
| [22]   | Maintenance text 2 |             |
| [23]   | Maintenance text 3 |             |

| Option | Name               | Description |
|--------|--------------------|-------------|
| [24]   | Maintenance text 4 |             |
| [25]   | Maintenance text 5 |             |
| [28]   | Clear logs         |             |

## Parameter 23-12 Maintenance Base

Table 1030: Parameter 23-12 Maintenance Base

| 23-12 Maintenance Base      |                                   |                               |
|-----------------------------|-----------------------------------|-------------------------------|
| Default value: Size related | Parameter type: Option, Array [6] | Setup: 1 setup                |
| Conversion index: -         | Data type: Uint8                  | Change during operation: True |

Select the time base to be associated with the preventive maintenance event.

| Option | Name            | Description  |
|--------|-----------------|--|
| [0]    | Disabled        | Disables the preventive maintenance event.   |
| [1]    | Running hours   | The number of hours the motor has run. Running hours are not reset at power-on. Specify the maintenance time interval in <i>parameter 23-13 Maintenance Interval</i> .   |
| [2]    | Operating hours | The number of hours the drive has run. Operating hours are not reset at power-on. Specify the maintenance time interval in <i>parameter 23-13 Maintenance Interval</i> . |
| [3]    | Date & time     | Uses the internal clock. Specify the date and time of the next maintenance occurrence in <i>parameter 23-14 Maintenance Date and Time</i> .                              |
| [4]    | No of counts    |  |

## Parameter 23-13 Maintenance Interval

Table 1031: Parameter 23-13 Maintenance Interval

| 23-13 Maintenance Interval |  |                               |
|----------------------------|--|-------------------------------|
| Default value: 1           | Parameter type: Range, 1 - 2147483647, Array [6] | Setup: 1 setup                |
| Conversion index: 0        | Data type: Uint32                                | Change during operation: True |

Set the interval associated with the current preventive maintenance event. This parameter is only used if [1] *Running Hours* or [2] *Operating Hours* is selected in *parameter 23-12 Maintenance Base*. The timer is reset in *parameter 23-15 Reset Maintenance Word*.

**Example**

A preventive maintenance event is set up Monday at 8:00. *Parameter 23-12 Maintenance Base* is [2] *Operating hours* and *parameter 23-13 Maintenance Interval* is 7 x 24 hours=168 hours. Next maintenance event is indicated the following Monday at 8:00. If this maintenance event is not reset until Tuesday at 9:00, the next occurrence is the following Tuesday at 9:00.

## Parameter 23-14 Maintenance Data and Time

Table 1032: Parameter 23-14 Maintenance Data and Time

| 23-14 Maintenance Data and Time |   |                               |
|---------------------------------|---|-------------------------------|
| Default value: Size related     | Parameter type: Range, 0 - 0, Array [6] | Setup: 1 setup                |
| Conversion index: 0             | Data type: TimeOfDay                    | Change during operation: True |

Set the date and time for the next maintenance occurrence if the preventive maintenance event is based on date/time. Date format depends on the setting in *parameter 0-71 Date Format* while the time format depends on the setting in *parameter 0-72 Time Format*.



**NOTICE**

The drive has no back-up of the clock function. The set date/time is reset to default (2000-01-01 00:00) after a power-down. In *parameter 0-79 Clock Fault*, it is possible to program a warning if the clock has not been set properly, for example after a power-down. Set the time at least 1 hour later than actual time.

**NOTICE**

When mounting a VLT® Analog I/O option MCB 109 option card, a battery back-up of the date and time is included.

Parameter 23-15 Reset Maintenance Word

Table 1033: Parameter 23-15 Reset Maintenance Word

| 23-15 Reset Maintenance Word    |                        |                               |
|---------------------------------|------------------------|-------------------------------|
| Default value: [0] Do not reset | Parameter type: Option | Setup: All setups             |
| Conversion index: -             | Data type: Uint8       | Change during operation: True |

**NOTICE**

When messages are reset, maintenance item, action, and maintenance date/time are not canceled. *Parameter 23-12 Maintenance Time Base* is set to [0] Disabled.

Set this parameter to [1] Do reset to reset the maintenance word in *parameter 16-96 Maintenance Word* and reset the message shown in the LCP. This parameter changes back to [0] Do not reset when pressing [OK].

| Option | Name         | Description |
|--------|--------------|-------------|
| [0]*   | Do not reset |             |
| [1]    | Do reset     |             |

Parameter 23-16 Maintenance Text

Table 1034: Parameter 23-16 Maintenance Text

| 23-16 Maintenance Text |  |                               |
|------------------------|--|-------------------------------|
| Default value: 0       | Parameter type: Range, 0 - 20, Array [6] | Setup: 1 setup                |
| Conversion index: 0    | Data type: VisStr[20]                    | Change during operation: True |

6 individual texts (Maintenance Text 0...Maintenance Text 5) can be written for use in either *parameter 23-10 Maintenance Item* or *parameter 23-11 Maintenance Action*. The text is written according to the guidelines in *parameter 0-37 Display Text 1*.

Parameter 23-18 Reset Mechanical Brake Counter

Table 1035: Parameter 23-18 Reset Mechanical Brake Counter

| 23-18 Reset Mechanical Brake Counter |                        |                               |
|--------------------------------------|------------------------|-------------------------------|
| Default value: [0] Do not reset      | Parameter type: Option | Setup: All setups             |
| Conversion index: -                  | Data type: Uint8       | Change during operation: True |

| Option | Name         | Description  |
|--------|--------------|--|
| [0]*   | Do not reset | Select this option to disable the reset of the mechanical brake counter.   |
| [1]    | Do reset     | Select this option to enable the reset of the mechanical brake counter. After resetting the mechanical brake counter, the parameter is set to [0] Do not reset, which is the default option. |

## 5.22 Parameter Group 24-\*\* Application Functions 2

### 5.22.1 24-0\* Emergency Mode

#### ⚠ CAUTION ⚠

The drive is only 1 component of an entire application system. Correct function of emergency mode depends on the correct design and selection of system components. Non-interruption of the drive due to emergency-mode operation could cause overpressure and damage the system and components. The drive itself could be damaged, or may cause damage or fire. Danfoss accepts no responsibility for errors, malfunctions, personal injury, or any damage to the drive itself or the components herein, application systems and components herein, or other property when the drive has been programmed for emergency mode. In no event shall Danfoss be liable to the end user or any other party for any direct or indirect, special, or consequential damage, or loss suffered by such party, which has occurred due to the drive being programmed and operated in emergency mode. Danfoss warranty is only affected or reduced if a critical alarm occurs during emergency-mode operation, and the drive is programmed to continue even though the application system would be damaged eventually.

If critical alarms have been activated during emergency mode operation, the drive informs the user that its performance and expected lifetime may be affected (*W280*), where an inspection of the drive may be needed to secure maximum operation in a new critical situation.

#### Background

Emergency mode is for use in critical situations where it is imperative for the motor to keep running, regardless of the normal protective functions of the drive. These situations could be ventilation fans in tunnels or stairwells, for instance, where continued operation of fan facilitates safe evacuation of personnel and protection of inventory if a fire occurs. Some selections of the emergency-mode function cause alarms and trip conditions to be disregarded, enabling the motor to run without interruption.

#### Activation

Emergency mode can be activated via digital input and/or over the fieldbus network. In digital activation, normal or inverse signals levels can be selected as continual fixed signals or as trigger pulse activation to fit the overall fire control system. It can operate in open loop with up to 8 different preset speeds or in closed loop with an external signal reference and feedback source. See *parameter group 5-1\* Digital Inputs* and *parameter 24-43 Emergency Mode Signal Operation*.

#### Messages in display

When emergency mode is activated, the display shows a status message *Emergency Mode* and a warning *Emergency Mode*. Once the emergency mode is deactivated, the status messages disappears and the warning is replaced by the warning *Emergency M Was Active*.

Digital and relay outputs can be configured for the status emergency mode messages, see *parameter group 5-3\* Digital Outputs* and *parameter group 5-4\* Relays*. Emergency mode messages can also be accessed in the warning word via serial communication (see relevant documentation). Access the status messages *Emergency Mode* via the extended status word.

Table 1036: Messages in Display

| Messages                             | Type        | LCP | Messages in display | Alarm word 1–3 | Warning word 2 | Warning word 3 | Ext. status word 2 |
|--------------------------------------|-------------|-----|---------------------|----------------|----------------|----------------|--------------------|
| <i>W200 Emergency Mode</i>           | Warning     | +   | +                   | –              | –              | +(bit 7)       | +(bit 25)          |
| <i>W201 Emerg. M Was Active</i>      | Warning     | +   | +                   | –              | +(bit 3)       | –              | –                  |
| <i>W202 Emerg. M Limits Exceeded</i> | Alarm (log) | +   | +                   | –              | –              | +(bit 9)       | +(bit 27)          |
| <i>W280 Emcy M Service Warning</i>   | Alarm (log) | +   | +                   | –              | –              | +(bit 10)      | –                  |
| <i>W281 Emcy OPR unexpected</i>      | Warning     | +   | +                   | –              | –              | +(bit 11)      | –                  |

#### Log

To see an overview of the emergency mode-related events, view the emergency mode log, *parameter group 18-1\* Emergency Mode Log*, or press [Alarm Log] on the LCP. The log includes up to 10 of the latest events. Warranty-affecting alarms have a higher priority than the other 2 types of events.

The emergency mode alarm log can only be reset by a Danfoss authorized service partner. To secure the emergency mode operation documentation, the 1<sup>st</sup> critical alarms can never be removed.

The following events are logged:

- W200 - Emergency mode.
- W201 - Emerg. M mode was act. (deactivated).
- W202 - Emerg. M limits exceeded covered by the activated critical alarm number.
- (W280) - Emcy M service warning - service is needed.
- (W281) - Emcy OPR unexpected - emergency mode does not work as expected.

All alarms are logged as usual, and critical emergency mode alarms are logged in the emergency mode log in *parameter group 18-1\* Emergency Mode Log*.

## N O T I C E

During emergency-mode operation, all stop commands to the drive are ignored, including coast/coast inverse and external interlock. The keypad is also locked during emergency mode to prevent user interference during operation of the safety system. However, if Safe Torque Off is available in the drive, this function is still active.

## N O T I C E

Emergency mode has a special live zero function for handling lost analog signal inputs used for emergency mode setpoint/feedback, for example, for handling a burnt cable. How emergency mode should continue in these live zero situations is configured in *parameter 6-02 Emergency Mode Live Zero Timeout Function*. If live zero is activated, *Emergency mode not working as expected* is activated so that a redundant system can take over or a setup change can be activated. A warning for live zero has a higher priority than the warning *Emergency mode* and will replace that information in the display.

## N O T I C E

If setting the command [11] *Start Reversing* on a digital input terminal in *parameter 5-10 Terminal 18 Digital Input*, the drive understands this as a reversing command.

### Parameter 24-00 Emergency Mode Function

Table 1037: Parameter 24-00 Emergency Mode Function

| 24-00 Emergency Mode Function |                        |                               |
|-------------------------------|------------------------|-------------------------------|
| Default value: [0] Disabled   | Parameter type: Option | Setup: 2 setups               |
| Conversion index: -           | Data type: Uint8       | Change during operation: True |

## N O T I C E

Alarms are produced or ignored in accordance with the selection in *parameter 24-09 Emergency Mode Alarm Handling*.

| Option | Name                | Description  |
|--------|---------------------|--|
| [0]*   | Disabled            | The emergency-mode function is not active.   |
| [1]    | Enabled-run forward | In this mode, the motor continues to operate in a clockwise direction. Works only in open loop. Set <i>parameter 24-01 Emergency Mode Configuration</i> to [0] <i>Open Loop</i> .          |
| [2]    | Enable-run reverse  | In this mode, the motor continues to operate in a counterclockwise direction. Works only in open loop. Set <i>parameter 24-01 Emergency Mode Configuration</i> to [0] <i>Open Loop</i> .   |
| [3]    | Enabled-coast       | In this mode, the output is disabled, and the motor is allowed to coast to stop.   |
| [4]    | Enable-run Fwd/Rev  |  |
| [8]    | Alarm suppression   | In this mode, the drive continues operation as normal, meaning on standard parameters and control operation, but where the alarms are suppressed as in normal emergency mode. The emcy LCP |

| Option | Name | Description   |
|--------|------|---|
|        |      | information and status word is updated as the emergency mode operation is logged in the emergency mode log. |

## Parameter 24-01 Emergency Mode Configuration

Table 1038: Parameter 24-01 Emergency Mode Configuration

| 24-01 Emergency Mode Configuration |                        |                               |
|------------------------------------|------------------------|-------------------------------|
| Default value: [0] Open loop       | Parameter type: Option | Setup: All setups             |
| Conversion index: -                | Data type: Uint8       | Change during operation: True |

### N O T I C E

Before adjusting the PID controller, set *parameter 24-09 Emergency Mode Alarm Handling* to [9] Trip, all alarms/test.

### N O T I C E

If [2] Enable-run reverse is selected in *parameter 24-00 Emergency Mode Function*, [3] Closed loop cannot be selected in *parameter 24-01 Emergency Mode Configuration*.

The emergency mode can be controlled in open loop with up to 8 different preset values (zones), or in closed loop by a reference and feedback signal. The reference and feedback signal can come via drive input signals or over the fieldbus.

| Op-tion | Name              | Description   |
|---------|-------------------|---|
| [0]*    | Speed open loop   | When emergency mode is active, the motor runs with a fixed speed based on a reference set. The unit is the same as selected in <i>parameter 0-02 Motor Speed Unit</i> .   |
| [1]     | Speed closed loop | When emergency mode is active, the built-in PID controller controls the speed based on the setpoint and a feedback signal selected in <i>parameter 24-07 Emergency Mode Feedback Source</i> . Select the unit in <i>parameter 24-02 Emergency Mode Unit</i> . For PID controller settings, use <i>parameter group 20-** FC Closed Loop</i> as for normal operation. The same PID configuration can be selected for both normal and emergency mode, and the operation can be continued as setup 1–4. |
| [3]     | Process           |   |

## Parameter 24-02 Emergency Mode Unit

Table 1039: Parameter 24-02 Emergency Mode Unit

| 24-02 Emergency Mode Unit   |                        |                               |
|-----------------------------|------------------------|-------------------------------|
| Default value: Size related | Parameter type: Option | Setup: All setups             |
| Conversion index: -         | Data type: Uint8       | Change during operation: True |

By default, emergency mode is configured for open-loop control where only the motor unit is selected in *parameter 0-02 Motor Speed Unit*. For closed-loop operation, select any of the following options.

| Option | Name | Description |
|--------|------|-------------|
| [0]    | None |             |
| [1]    | %    |             |
| [2]    | RPM  |             |
| [3]    | Hz   |             |

| Option | Name                | Description |
|--------|---------------------|-------------|
| [4]    | Nm                  |             |
| [5]    | PPM                 |             |
| [10]   | 1/min               |             |
| [11]   | RPM                 |             |
| [12]   | Pulse/s             |             |
| [20]   | l/s                 |             |
| [21]   | l/min               |             |
| [22]   | l/h                 |             |
| [23]   | m <sup>3</sup> /s   |             |
| [24]   | m <sup>3</sup> /min |             |
| [25]   | m <sup>3</sup> /h   |             |
| [30]   | kg/s                |             |
| [31]   | kg/min              |             |
| [32]   | kg/h                |             |
| [33]   | t/min               |             |
| [34]   | t/h                 |             |
| [40]   | m/s                 |             |
| [41]   | m/min               |             |
| [45]   | m                   |             |
| [60]   | °C                  |             |
| [70]   | mbar                |             |
| [71]   | bar                 |             |
| [72]   | Pa                  |             |
| [73]   | kPa                 |             |
| [74]   | m WG                |             |
| [80]   | kW                  |             |
| [120]  | GPM                 |             |
| [121]  | gal/s               |             |
| [122]  | gal/min             |             |
| [123]  | gal/h               |             |
| [124]  | CFM                 |             |
| [125]  | ft <sup>3</sup> /s  |             |

| Option | Name                 | Description |
|--------|----------------------|-------------|
| [126]  | ft <sup>3</sup> /min |             |
| [127]  | ft <sup>3</sup> /h   |             |
| [130]  | lb/s                 |             |
| [131]  | lb/min               |             |
| [132]  | lb/h                 |             |
| [140]  | ft/s                 |             |
| [141]  | ft/min               |             |
| [145]  | ft                   |             |
| [150]  | lb ft                |             |
| [160]  | °F                   |             |
| [170]  | psi                  |             |
| [171]  | lb/in <sup>2</sup>   |             |
| [172]  | in WG                |             |
| [173]  | ft WG                |             |
| [176]  | kpsi                 |             |
| [177]  | MPa                  |             |
| [178]  | kBar                 |             |
| [180]  | HP                   |             |

Parameter 24-03 Emergency Mode Min Reference

Table 1040: Parameter 24-03 Emergency Mode Min Reference

| 24-03 Emergency Mode Min Reference |  |                               |
|------------------------------------|--|-------------------------------|
| Default value: Size related        | Parameter type: Range, -999999.999 - par. 24-04 EmergencyMode-<br>MaxReference | Setup: All setups             |
| Conversion index: -3               | Data type: Int32   | Change during operation: True |

Minimum value to the reference/setpoint (limiting the sum of values in *parameter 24-05 Emergency Mode Preset Reference* and value of signal on input selected in *parameter 24-06 Emergency Mode Reference Source*). If running in open loop when emergency mode is active, the unit is selected by the setting *parameter 0-02 Motor Speed Unit*. For closed loop, select the unit in *parameter 24-02 Emergency Mode Unit*.

Parameter 24-04 Emergency Mode Max Reference

Table 1041: Parameter 24-04 Emergency Mode Max Reference

| 24-04 Emergency Mode Max Reference |   |                               |
|------------------------------------|---|-------------------------------|
| Default value: Size related        | Parameter type: Range, par. 24-03 - 999999.999 EmergencyMode-<br>MinReference | Setup: All setups             |
| Conversion index: -3               | Data type: Int32  | Change during operation: True |

This parameter defines the maximum speed reference which the emergency mode can operate to, although the motor limits in *parameter 4-10 Motor Speed Direction* have the highest priority. This maximum value is also used as reference value for the 8 preset values calculations in %. If running in open loop when emergency mode is active, the unit is selected by setting *parameter 0-02 Motor Speed Unit*. For closed loop, select the unit in *parameter 24-02 Emergency Mode Unit*.

Parameter 24-05 Emergency Mode Preset Reference

Table 1042: Parameter 24-05 Emergency Mode Preset Reference

| 24-05 Emergency Mode Preset Reference |   |                               |
|---------------------------------------|---|-------------------------------|
| Default value: 0%                     | Parameter type: Range, -100 - 100%, Array [8] | Setup: All setups             |
| Conversion index: -2                  | Data type: Int16                              | Change during operation: True |

A parameter array with 8 elements (0–7). The 8 present values (zones) are for open-loop control. Index [0] is used for basic emergency mode control. Indexes 1–7 are used to enhance emergency mode control, which also overwrites the basic control. More reference value can be added via *parameter group 24-\*\* Application Functions 2*.

Parameter 24-06 Emergency Mode Reference Source

Table 1043: Parameter 24-06 Emergency Mode Reference Source

| 24-06 Emergency Mode Reference Source |                        |                               |
|---------------------------------------|------------------------|-------------------------------|
| Default value: [0] No function        | Parameter type: Option | Setup: All setups             |
| Conversion index: -                   | Data type: Uint8       | Change during operation: True |

Select the external reference input to be used for emergency mode. In open-loop mode, this signal value is added to the preset values in *parameter 24-05 Emergency Mode Preset Reference*. There may be a different units scaling between preset and external values.

| Option | Name                | Description   |
|--------|---------------------|---|
| [0]*   | No function         |   |
| [1]    | Analog input 53     |   |
| [2]    | Analog input 54     |   |
| [7]    | Pulse input 29      | <div style="text-align: center; background-color: #cccccc; padding: 5px;"><b>NOTICE</b></div> <div style="border: 1px solid black; padding: 5px; margin-top: 5px;">This option is only available in FC 302.</div> |
| [8]    | Pulse input 33      |   |
| [11]   | Local bus reference | Serial inputs from internal COM interfaces.   |
| [20]   | Digital pot.meter   |   |
| [21]   | Analog input X30/11 |   |
| [22]   | Analog input X30/12 |   |
| [24]   | Analog input X42/3  |   |
| [25]   | Analog input X42/5  |   |
| [37]   | Analog input X49/1  |   |
| [38]   | Analog input X49/3  |   |
| [39]   | Analog input X49/5  |   |
| [133]  | Fieldbus REF 1      | A reference value can also come via selected fieldbus.  |

Parameter 24-07 Emergency Mode Feedback Source

Table 1044: Parameter 24-07 Emergency Mode Feedback Source

| 24-07 Emergency Mode Feedback Source |                        |                               |
|--------------------------------------|------------------------|-------------------------------|
| Default value: [0] No function       | Parameter type: Option | Setup: All setups             |
| Conversion index: -                  | Data type: Uint8       | Change during operation: True |

In emergency mode closed-loop operation, feedback is requested for the internal PID controller. Select the feedback input to be used for the feedback signal.

| Option | Name                | Description  |
|--------|---------------------|--|
| [0]*   | No function         |  |
| [1]    | Analog input 53     |  |
| [2]    | Analog input 54     |  |
| [3]    | Frequency input 29  | <div style="text-align: center; background-color: #cccccc; padding: 5px;"><b>NOTICE</b></div> <div style="border: 1px solid black; padding: 5px; margin: 5px auto; width: fit-content;">This option is only available in FC 302.</div> |
| [4]    | Frequency input 33  |  |
| [7]    | Analog input X30/11 |  |
| [8]    | Analog input X30/12 |  |
| [16]   | Analog input X49/1  |  |
| [17]   | Analog input X49/3  |  |
| [18]   | Analog input X49/5  |  |
| [99]   | Normal feedback     |  |

Parameter 24-09 Emergency Mode Alarm Handling

Table 1045: Parameter 24-09 Emergency Mode Alarm Handling

| 24-09 Emergency Mode Alarm Handling      |                        |                                |
|--|------------------------|--------------------------------|
| Default value: [1] Trip, critical alarms | Parameter type: Option | Setup: 2 setups                |
| Conversion index: -                      | Data type: Uint8       | Change during operation: False |

**NOTICE**

Warranty-affecting alarms. Certain alarms can affect the lifetime of the drive. Should 1 of these ignored alarms occur while in emergency mode, the alarms are logged and stored in the emergency-mode log.

**NOTICE**

The setting in *parameter 14-20 Reset Mode* is disregarded if emergency mode is active (see *parameter group 24-0\* Emergency Mode*).

Select an option to define the response to alarms when emergency mode is active and an alarm is issued.



| Option | Name                        | Description   |
|--------|-----------------------------|---|
| [0]    | Trip+reset, critical alarms | Alarms are ignored even though damage may be caused, except for the critical alarms mentioned in the following table. When these alarms occur, the drive trips immediately, followed by an automatic reset and restarts even if the operation leads to an infinite loop of trip and restart.      |
| [1]*   | Trip, critical alarms       | Alarms are ignored even though damage may be caused, except for the critical alarms mentioned in the following table. For the critical alarms, a trip is caused. A manual reset is required before restart. A manual restart requires disabling emergency mode and enabling emergency mode again. |
| [2]    | Trip, all alarms/test       | Option for testing emergency mode operation without compromising the normal handling of warnings and alarms. All alarms are handled as normally defined in <a href="#">7.1.2 Alarm/Warning Code List</a>  |

Table 1046: Emergency Mode Alarm Handling

| Alarm number | Description              | Emergency mode alarm handling selected in <i>parameter 24-09 Emergency Mode Alarm Handling</i> . Critical alarms cause a trip. |          |                          | Warranty-affecting alarms in emergency mode |
|--------------|--------------------------|--|----------|--------------------------|---|
|              |                          | [0] Trip+reset   | [1] Trip | [2] Test                 |   |
| 4            | Mains phase loss         | Ignore   | Ignore   | (Warning/trip)           | X   |
| 7            | DC voltage high          | Trip+reset   | Trip     | Warning/trip             |   |
| 8            | DC voltage low           | Trip+reset   | Trip     | Warning/trip             |   |
| 9            | Inverter overld.         | Ignore   | Ignore   | (Warning/trip)           | X   |
| 13           | Over current             | Trip+reset   | Trip     | (Warning/trip/trip lock) |   |
| 14           | Ground fault             | Trip+reset   | Trip     | (Warning/trip/trip lock) |   |
| 16           | Short circuit            | Trip+reset   | Trip     | (Trip/trip lock)         |   |
| 29           | Power module temp        | Ignore   | Ignore   | (Warning/trip/trip lock) | X   |
| 33           | Inrush fault             | Ignore   | Ignore   | Trip/trip lock           | X   |
| 38           | Internal fault           | Ignore   | Ignore   | Trip/trip lock           | X   |
| 39           | Heatsink sensor          | Ignore   | Ignore   | (Trip/trip lock)         | X   |
| 45           | Ground fault 2           | Ignore   | Ignore   |                          |   |
| 65           | Ctrl. card temp          | Ignore   | Ignore   | Warning/trip/(trip lock) | X   |
| 68           | Safe stop                | Trip   | Trip     | Trip                     |   |
| 69           | Pwr card temp.           | Ignore   | Ignore   | Trip/(trip lock)         | X   |
| 79           | Illegal PS config        | Ignore   | Ignore   |                          |   |
| 101          | Speed monitor (FC 302)   | Ignore   | Ignore   |                          |   |
| 200          | Emergency mode           | Ignore   | Ignore   |                          |   |
| 201          | Emerg. M was active      | Ignore   | Ignore   |                          |   |
| 202          | Emerg. M limits exceeded | Ignore   | Ignore   |                          |   |
| 244          | Heatsink temp            | Ignore   | Ignore   | (Trip/trip lock)         | X   |

| Alarm number | Description                 | Emergency mode alarm handling selected in <i>parameter 24-09 Emergency Mode Alarm Handling</i> . Critical alarms cause a trip. |        |                  | Warranty-affecting alarms in emergency mode |
|--------------|-----------------------------|--|--------|------------------|---|
|              |                             | Ignore   | Ignore | (Trip/trip lock) |   |
| 245          | Heatsink sensor             | Ignore   | Ignore | (Trip/trip lock) | X   |
| 247          | Pwr.card temp               | Ignore   | Ignore | (Trip/trip lock) | X   |
| 280          | Emergency m service warning | Ignore   | Ignore |                  |   |
| 281          | Emcy OPR unexpected         | Ignore   | Ignore |                  |   |

### 5.22.2 24-1\* Drive Bypass

The drive includes a feature which can be used to automatically activate an external electro-mechanical bypass if the drive trips or if there is an emergency-mode coast (see *parameter 24-00 Emergency Mode Function*).

The bypass switches the motor top operation direct on line. The external bypass is activated by 1 of the digital outputs or relays in the drive when programmed in *parameter group 5-3\* Digital Outputs* or *parameter group 5-4\* Relays*.

## NOTICE

After enabling the drive bypass function, the drive is no longer safety certified (for using the Safe Torque Off in versions, where included).

To deactivate the drive bypass at normal operation (emergency mode not activated), carry out 1 of the following actions:

- Press [Off] on the LCP, or program 2 of the digital inputs for Hand On-Off-Auto.
- Activate external interlock via digital input.
- Carry out a power cycle.

## NOTICE

The drive bypass cannot be deactivated if in emergency mode. It can be deactivated only by either removing the emergency mode command signal or the power supply to the drive.

When the drive bypass function is activated, the display on the LCP shows the status message *Drive Bypass*. This message has a higher priority than the emergency mode status messages. When the automatic drive bypass function is enabled, it cuts in the external bypass according to the sequence shown in [Illustration 96](#).

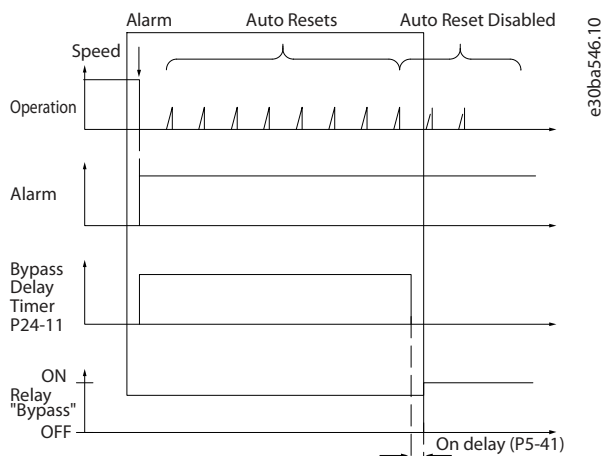

**Illustration 96: Drive Bypass**

The status can be read in the extended status word 2, bit number 24.

## Parameter 24-10 Drive Bypass Function

Table 1047: Parameter 24-10 Drive Bypass Function

| 24-10 Drive Bypass Function |                        |                               |
|-----------------------------|------------------------|-------------------------------|
| Default value: [0] Disabled | Parameter type: Option | Setup: 2 setups               |
| Conversion index: -         | Data type: Uint8       | Change during operation: True |

## N O T I C E

After enabling the drive bypass function, the Safe Torque Off function (where included) does not comply with standard EN 954-1, Cat. 3 installations.

This parameter determines the circumstances that activate the drive bypass function.

| Option | Name                  | Description  |
|--------|-----------------------|--|
| [0]*   | Disabled              |  |
| [1]    | Enabled               | <p>If in normal operation, the drive bypass function is activated under the following conditions:</p> <ul style="list-style-type: none"> <li>• If there is a trip lock or a trip.</li> <li>• After the number of reset attempts programmed in <i>parameter 14-20 Reset Mode</i>.</li> <li>• If the bypass delay timer (<i>parameter 24-11 Drive Bypass Delay Time</i>) expires before reset attempts have been completed.</li> </ul> |
| [2]    | Enabled (Fire M Only) |  |

## Parameter 24-11 Drive Bypass Delay Time

Table 1048: Parameter 24-11 Drive Bypass Delay Time

| 24-11 Drive Bypass Delay Time |                                  |                               |
|-------------------------------|----------------------------------|-------------------------------|
| Default value: 0 s            | Parameter type: Range, 0 - 600 s | Setup: 2 setups               |
| Conversion index: 0           | Data type: Uint16                | Change during operation: True |

Programmable in 1 s increments. Once the bypass function is activated in accordance with the setting in *parameter 24-10 Drive Bypass Function*, the bypass delay timer begins to operate. If the drive has been set for several restart attempts, the timer continues to run while the drive tries to restart. Should the motor have restarted within the time period of the bypass delay timer, the timer is reset. Should the motor fail to restart at the end of the bypass delay time, the drive bypass relay programmed for bypass in *parameter 5-40 Function Relay* is activated. If a relay delay has also been programmed in *parameter 5-41 On Delay, Relay, [Relay]* or *parameter 5-42 Off Delay, Relay [Relay]*, this time must also elapse before the relay action is performed. Where no restart attempts are programmed, the timer runs for the delay period set in this parameter and activates the drive bypass relay, which has been programmed for bypass in *parameter 5-40 Function Relay*. If a relay delay has also been programmed in *parameter 5-41 On Delay, Relay* or *parameter 5-42 Off Delay, Relay [Relay]*, this time must also elapse before the relay action is performed.

### 5.22.3 24-4\* Emergency Mode 2

Configure the ramp parameters for emergency mode:

- Ramp type
- Ramping times (duration of acceleration and deceleration)
- Level of jerk compensation for S-ramps

Start by setting the linear ramping times corresponding to [Illustration 97](#) and [Illustration 98](#).

#### Illustration 97: Linear Ramping Times

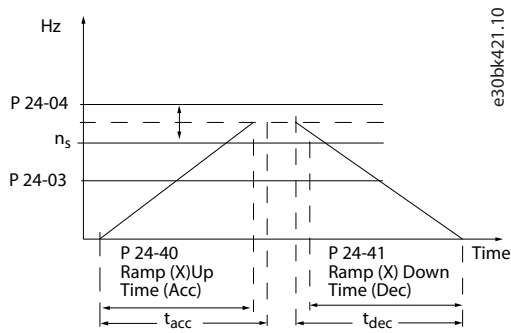

If S-ramps are selected, set the level of non-linear jerk compensation required. Set jerk compensation by defining the proportion of ramp-up and ramp-down times where acceleration and deceleration are variable (that is, increasing or decreasing). The S-ramp acceleration and deceleration settings are defined as a percentage of the actual ramp time.

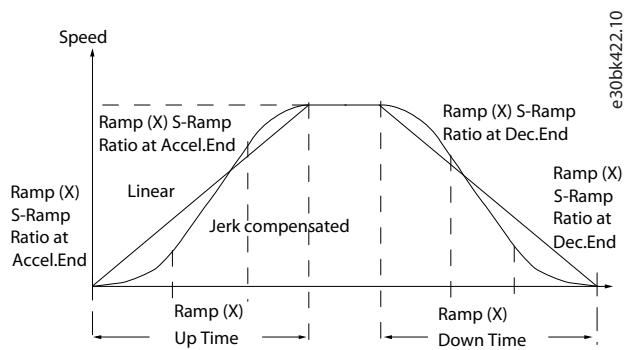

Illustration 98: Non-linear Ramping Times

Parameter 24-40 Emergency Mode Ramp Up Time

Table 1049: Parameter 24-40 Emergency Mode Ramp Up Time

| 24-40 Emergency Mode Ramp Up Time |  |                               |
|-----------------------------------|--|-------------------------------|
| Default value: 3 s                | Parameter type: Range, 1.0 - 3600 s, Array [8] | Setup: All setups             |
| Conversion index: -2              | Data type: Uint32                              | Change during operation: True |

This ramp time is used for acceleration while emergency mode is active.

Parameter 24-41 Emergency Mode Ramp Down Time

Table 1050: Parameter 24-41 Emergency Mode Ramp Down Time

| 24-41 Emergency Mode Ramp Down Time |  |                               |
|-------------------------------------|--|-------------------------------|
| Default value: 3 s                  | Parameter type: Range, 1.0 - 3600 s, Array [8] | Setup: All setups             |
| Conversion index: -2                | Data type: Uint32                              | Change during operation: True |

This ramp time is used for deceleration while emergency mode is active.

Parameter 24-42 Timeout for Emergency Mode Test

Table 1051: Parameter 24-42 Timeout for Emergency Mode Test

| 24-42 Timeout for Emergency Mode Test |                                   |                               |
|---------------------------------------|-----------------------------------|-------------------------------|
| Default value: 10 min                 | Parameter type: Range, 1 - 60 min | Setup: All setups             |
| Conversion index: 70                  | Data type: Uint8                  | Change during operation: True |

A digital impulse triggers the emergency mode operation with stop on all alarms as option [2] Trip, all alarms/test in parameter 24-09 Emergency Mode Alarms Handling. This test impulse signal can only activate 1 test time period and the normal emergency mode operation takes over as soon as the test time ends, or it stops the test period if the emergency mode signal disappears. Only "normal

high impulse" signals can trigger the test timer and test information is included in the LCP and status word, as emergency mode output "not operating as expected" is activated.

Parameter 24-43 Emergency Mode Signal Operation

Table 1052: Parameter 24-43 Emergency Mode Signal Operation

| 24-43 Emergency Mode Signal Operation    |                        |                               |
|--|------------------------|-------------------------------|
| Default value: [0] Standard, active-high | Parameter type: Option | Setup: 1 setup                |
| Conversion index: -                      | Data type: Uint8       | Change during operation: True |

**NOTICE**

Ensure that the correct input selections and connections are in place as it is not possible to operation the LCP while emergency mode is activated.

**NOTICE**

If signal handling is set to inverse, a low [196] EM active and a low [197] EM was active indicate that the drive is off or power cycling, which can be used to activate a redundant system.

Select how emergency mode input and output signals are handled. Before changing this parameter, disable *parameter 24-00 Emergency Mode Function*.

| Option | Name                  | Description  |
|--------|-----------------------|--|
| [0]*   | Standard, active-high | Normal high input and output signals operate the emergency mode function as long as they are active (high).  |
| [1]    | Inverse, active-low   | This option adds safety rules to ensure that emergency mode still operates if a signal is lost.  |
| [2]    | Impulse, set-reset    | This option activates and stops the emergency mode operation on high signal impulse. Operation mode is defined and activated by selected input signals and is frozen 2 s after the 1 <sup>st</sup> signal activation. Reset signal has the highest priority and is required to stop operation or switch to a new operation configuration. A valid signal impulse has to be active for minimum 2 s. |

**NOTICE**

LCP copy and software download only accept parameter changes if *parameter 24-00 Emergency Mode* is set to [0] Disabled.

5.22.4 24-9\* Multi-Motor Funct.

Parameter 24-90 Missing Motor Function

Table 1053: Parameter 24-90 Missing Motor Function

| 24-90 Missing Motor Function |                        |                               |
|------------------------------|------------------------|-------------------------------|
| Default value: [0] Off       | Parameter type: Option | Setup: All setups             |
| Conversion index: -          | Data type: Uint8       | Change during operation: True |

Select the action to be taken if the motor current is below the limit calculated as a function of the output frequency. The function is used for detecting, for example, a missing motor in multi-motor applications.

| Option | Name    | Description |
|--------|---------|-------------|
| [0]*   | Off     |             |
| [1]    | Warning |             |

## Parameter 24-91 Missing Motor Coefficient 1

Table 1054: Parameter 24-91 Missing Motor Coefficient 1

| 24-91 Missing Motor Coefficient 1 |                                 |                               |
|-----------------------------------|---------------------------------|-------------------------------|
| Default value: 0                  | Parameter type: Range, -10 - 10 | Setup: All setups             |
| Conversion index: -4              | Data type: Int32                | Change during operation: True |

Enter the cubic coefficient of the missing motor detection-function multiplied by 1000.

## Parameter 24-92 Missing Motor Coefficient 2

Table 1055: Parameter 24-92 Missing Motor Coefficient 2

| 24-92 Missing Motor Coefficient 2 |                                   |                               |
|-----------------------------------|-----------------------------------|-------------------------------|
| Default value: 0                  | Parameter type: Range, -100 - 100 | Setup: All setups             |
| Conversion index: -4              | Data type: Int32                  | Change during operation: True |

Enter the quadratic coefficient of the missing motor detection-function multiplied by 1000.

## Parameter 24-93 Missing Motor Coefficient 3

Table 1056: Parameter 24-93 Missing Motor Coefficient 3

| 24-93 Missing Motor Coefficient 3 |                                   |                               |
|-----------------------------------|-----------------------------------|-------------------------------|
| Default value: 0                  | Parameter type: Range, -100 - 100 | Setup: All setups             |
| Conversion index: -4              | Data type: Int32                  | Change during operation: True |

Enter the linear coefficient of the missing motor detection-function multiplied by 1000.

## Parameter 24-94 Missing Motor Coefficient 4

Table 1057: Parameter 24-94 Missing Motor Coefficient 4

| 24-94 Missing Motor Coefficient 4 |                                   |                               |
|-----------------------------------|-----------------------------------|-------------------------------|
| Default value: 0                  | Parameter type: Range, -500 - 500 | Setup: All setups             |
| Conversion index: -3              | Data type: Int32                  | Change during operation: True |

Enter the constant coefficient of the missing motor detection-function multiplied by 1000.

## Parameter 24-95 Locked Rotor Function

Table 1058: Parameter 24-95 Locked Rotor Function

| 24-95 Locked Rotor Function |                        |                               |
|-----------------------------|------------------------|-------------------------------|
| Default value: [0] Off      | Parameter type: Option | Setup: All setups             |
| Conversion index: -         | Data type: UInt8       | Change during operation: True |

Select the action to be taken if the motor current is above the limit calculated as a function of the output frequency. The function is used for detecting, for example, a locked rotor in multi-motor applications.

| Option | Name    | Description |
|--------|---------|-------------|
| [0]*   | Off     |             |
| [1]    | Warning |             |

Parameter 24-96 Locked Rotor Coefficient 1

Table 1059: Parameter 24-96 Locked Rotor Coefficient 1

| 24-96 Locked Rotor Coefficient 1 |                                 |                               |
|----------------------------------|---------------------------------|-------------------------------|
| Default value: 0                 | Parameter type: Range, -10 - 10 | Setup: All setups             |
| Conversion index: -4             | Data type: Int32                | Change during operation: True |

Enter the cubic coefficient of the locked-rotor detection function multiplied by 1000.

Parameter 24-97 Locked Rotor Coefficient 2

Table 1060: Parameter 24-97 Locked Rotor Coefficient 2

| 24-97 Locked Rotor Coefficient 2 |                                   |                               |
|----------------------------------|-----------------------------------|-------------------------------|
| Default value: 0                 | Parameter type: Range, -100 - 100 | Setup: All setups             |
| Conversion index: -4             | Data type: Int32                  | Change during operation: True |

Enter the quadratic coefficient of the locked-rotor detection function multiplied by 1000.

Parameter 24-98 Locked Rotor Coefficient 3

Table 1061: Parameter 24-98 Locked Rotor Coefficient 3

| 24-98 Locked Rotor Coefficient 3 |                                   |                               |
|----------------------------------|-----------------------------------|-------------------------------|
| Default value: 0                 | Parameter type: Range, -100 - 100 | Setup: All setups             |
| Conversion index: -4             | Data type: Int32                  | Change during operation: True |

Enter the linear coefficient of the locked-rotor detection function multiplied by 1000.

Parameter 24-99 Locked Rotor Coefficient 4

Table 1062: Parameter 24-99 Locked Rotor Coefficient 4

| 24-99 Locked Rotor Coefficient 4 |                                   |                               |
|----------------------------------|-----------------------------------|-------------------------------|
| Default value: 0                 | Parameter type: Range, -500 - 500 | Setup: All setups             |
| Conversion index: -3             | Data type: Int32                  | Change during operation: True |

Enter the constant coefficient of the locked-rotor detection function multiplied by 1000.

## 5.23 Parameter Group 30-\*\* Special Features

### 5.23.1 30-0\* Wobble Function

The wobble function is primarily used for synthetic yarn winding applications. The wobble option is installed in the drive controlling the traverse drive. The yarn moves back and forth in a diamond pattern across the surface of the yarn package. To prevent a build-up of yarn at the same points at the surface, this pattern must be altered. The wobble option can accomplish this by continuously varying the traverse velocity in a programmable cycle. The wobble function is created by superimposing a delta frequency around a center frequency. To compensate for the inertia in the system, a quick frequency jump can be included. Suitable for elastic yarn applications, the option features a randomized wobble ratio.

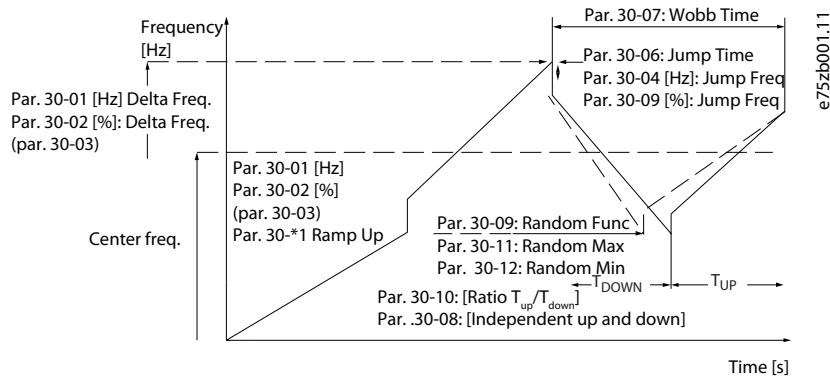

Illustration 99: Wobble Function

Parameter 30-00 Wobble Mode

Table 1063: Parameter 30-00 Wobble Mode

| 30-00 Wobble Mode                        |                        |                                |
|--|------------------------|--------------------------------|
| Default value: [0] Abs. freq., abs. time | Parameter type: Option | Setup: All setups              |
| Conversion index: -                      | Data type: Uint8       | Change during operation: False |

**NOTICE**

This parameter cannot be changed while the motor is running.

The standard speed open-loop mode in *parameter 1-00 Configuration Mode* is extended with a wobble function. In this parameter, it is possible to select which method to be used for the wobbler. Set the parameters as absolute values (direct frequencies) or as relative values (percentage of other parameter). Set the wobble cycle time as an absolute value or as independent up and down times. When using an absolute cycle time, the up and down times are configured through the wobble ratio.

| Option | Name                     | Description |
|--------|--------------------------|-------------|
| [0]*   | Abs. freq., abs. time    |             |
| [1]    | Abs. freq., up/down time |             |
| [2]    | Rel. freq., abs. time    |             |
| [3]    | Rel. freq., up/down time |             |

Parameter 30-01 Wobble Delta Frequency [Hz]

Table 1064: Parameter 30-01 Wobble Delta Frequency [Hz]

| 30-01 Wobble Delta Frequency [Hz] |                                  |                               |
|-----------------------------------|----------------------------------|-------------------------------|
| Default value: 5 Hz               | Parameter type: Range, 0 - 25 Hz | Setup: All setups             |
| Conversion index: -1              | Data type: Uint8                 | Change during operation: True |

The delta frequency determines the magnitude of the wobble frequency. The delta frequency is superimposed on the center frequency. *Parameter 30-01 Wobble Delta Frequency [Hz]* contains both the positive and negative delta frequency. The setting of *parameter 30-01 Wobble Delta Frequency [Hz]* must thus not exceed the setting of the center frequency. The initial ramp-up time from standstill until the wobble sequence runs is determined in *parameter group 3-1\* References*.



## Parameter 30-02 Wobble Delta Frequency [%]

Table 1065: Parameter 30-02 Wobble Delta Frequency [%]

| 30-02 Wobble Delta Frequency [%] |                                 |                               |
|----------------------------------|---------------------------------|-------------------------------|
| Default value: 25%               | Parameter type: Range, 0 - 100% | Setup: All setups             |
| Conversion index: 0              | Data type: Uint8                | Change during operation: True |

The delta frequency can also be expressed as a percentage of the center frequency and can thus be maximum 100%. The function is the same as for *parameter 30-01 Wobble Delta Frequency [Hz]*.

## Parameter 30-03 Wobble Delta Freq. Scaling Resource

Table 1066: Parameter 30-03 Wobble Delta Freq. Scaling Resource

| 30-03 Wobble Delta Freq. Scaling Resource |                        |                               |
|---|------------------------|-------------------------------|
| Default value: [0] No function            | Parameter type: Option | Setup: All setups             |
| Conversion index: -                       | Data type: Uint8       | Change during operation: True |

Select the drive input to be used for scaling the delta frequency setting.

| Option | Name                | Description   |
|--------|---------------------|---|
| [0]*   | No function         |   |
| [1]    | Analog input 53     |   |
| [2]    | Analog input 54     |   |
| [3]    | Frequency input 29  | <div style="text-align: center; background-color: #cccccc; padding: 5px;"><b>NOTICE</b></div> <div style="border: 1px solid black; padding: 5px; margin-top: 5px;">This option is only available in FC 302.</div> |
| [4]    | Frequency input 33  |   |
| [7]    | Analog input X30/11 |   |
| [8]    | Analog input X30/12 |   |
| [15]   | Analog input X48/2  |   |
| [16]   | Analog input X49/1  |   |
| [17]   | Analog input X49/3  |   |
| [18]   | Analog input X49/5  |   |

## Parameter 30-04 Wobble Jump Frequency [Hz]

Table 1067: Parameter 30-04 Wobble Jump Frequency [Hz]

| 30-04 Wobble Jump Frequency [Hz] |                                    |                               |
|----------------------------------|------------------------------------|-------------------------------|
| Default value: 0 Hz              | Parameter type: Range, 0 - 20.0 Hz | Setup: All setups             |
| Conversion index: -1             | Data type: Uint8                   | Change during operation: True |

The jump frequency is used to compensate for the inertia in the traverse system. If a jump in the output frequency is required at the boundaries of the wobble sequence, the frequency jump is set in this parameter. If the traverse system has a very high inertia, a high jump frequency may create a torque limit warning or trip or an overvoltage warning or trip. This parameter can only be changed in stop mode.

## Parameter 30-05 Wobble Jump Frequency [%]

Table 1068: Parameter 30-05 Wobble Jump Frequency [%]

| 30-05 Wobble Jump Frequency [%] |                                  |                               |
|---------------------------------|----------------------------------|-------------------------------|
| Default value: 0%               | Parameter type: Range, 0 - 100 % | Setup: All setups             |
| Conversion index: 0             | Data type: Uint8                 | Change during operation: True |

The jump frequency can also be expressed as a percentage of the center frequency. The function is the same as for *parameter 30-04 Wobble Jump Frequency [Hz]*.

## Parameter 30-06 Wobble Jump Time

Table 1069: Parameter 30-06 Wobble Jump Time

| 30-06 Wobble Jump Time      |  |                               |
|-----------------------------|--|-------------------------------|
| Default value: Size related | Parameter type: Range, 0.005 - 5.000 s | Setup: All setups             |
| Conversion index: -3        | Data type: Uint16                      | Change during operation: True |

This parameter determines the slope of the jump ramp at the maximum and minimum wobble frequency.

## Parameter 30-07 Wobble Sequence Time

Table 1070: Parameter 30-07 Wobble Sequence Time

| 30-07 Wobble Sequence Time |                                   |                               |
|----------------------------|-----------------------------------|-------------------------------|
| Default value: 10 s        | Parameter type: Range, 1 - 1000 s | Setup: All setups             |
| Conversion index: -1       | Data type: Uint16                 | Change during operation: True |

This parameter determines the wobble sequence period. This parameter can only be changed in stop mode.

$$\text{Wobble time} = t_{\text{up}} + t_{\text{down}}$$

## Parameter 30-08 Wobble Up/Down Time

Table 1071: Parameter 30-08 Wobble Up/Down Time

| 30-08 Wobble Up/Down Time |  |                               |
|---------------------------|--|-------------------------------|
| Default value: 5 s        | Parameter type: Range, 0.1 - 1000 s, Array [2] | Setup: All setups             |
| Conversion index: -1      | Data type: Uint16                              | Change during operation: True |

Defines the individual up and down times for each wobble cycle.

## Parameter 30-09 Wobble Random Function

Table 1072: Parameter 30-09 Wobble Random Function

| 30-09 Wobble Random Function |                        |                               |
|------------------------------|------------------------|-------------------------------|
| Default value: [0] Off       | Parameter type: Option | Setup: All setups             |
| Conversion index: -          | Data type: Uint8       | Change during operation: True |

| Option | Name | Description |
|--------|------|-------------|
| [0]*   | Off  |             |
| [1]    | On   |             |

## Parameter 30-10 Wobble Ratio

Table 1073: Parameter 30-10 Wobble Ratio

| 30-10 Wobble Ratio   |                                 |                               |
|----------------------|---------------------------------|-------------------------------|
| Default value: 1     | Parameter type: Range, 0.1 - 10 | Setup: All setups             |
| Conversion index: -1 | Data type: Uint8                | Change during operation: True |

If the ratio 0.1 is selected:  $t_{\text{down}}$  is 10 times greater than  $t_{\text{up}}$ . If the ratio 10 is selected:  $t_{\text{up}}$  is 10 times greater than  $t_{\text{down}}$ .

Center frequency

Use *parameter group 3-1\* References* to set the center frequency.

## Parameter 30-11 Wobble Random Ratio Max.

Table 1074: Parameter 30-11 Wobble Random Ratio Max.

| 30-11 Wobble Random Ratio Max. |  |                               |
|--------------------------------|--|-------------------------------|
| Default value: 10              | Parameter type: Range, par. 17-53 - 10 | Setup: All setups             |
| Conversion index: -1           | Data type: Uint8                       | Change during operation: True |

Enter the maximum allowed wobble ratio.

## Parameter 30-12 Wobble Random Ratio Min.

Table 1075: Parameter 30-12 Wobble Random Ratio Min.

| 30-12 Wobble Random Ratio Min. |   |                               |
|--------------------------------|---|-------------------------------|
| Default value: 0.1             | Parameter type: Range, 0.1 - par. 30-11 | Setup: All setups             |
| Conversion index: -1           | Data type: Uint8                        | Change during operation: True |

Enter the minimum allowed wobble ratio.

## Parameter 30-19 Wobble Delta Freq. Scaled

Table 1076: Parameter 30-19 Wobble Delta Freq. Scaled

| 30-19 Wobble Delta Freq. Scaled |                                    |                                |
|---------------------------------|------------------------------------|--------------------------------|
| Default value: 0 Hz             | Parameter type: Range, 0 - 1000 Hz | Setup: All setups              |
| Conversion index: -1            | Data type: Uint16                  | Change during operation: False |

Readout parameter. View the actual wobble delta frequency after scaling has been applied.

## 5.23.2 30-2\* Adv. Start Adjust

## NOTICE

This parameter group is only available in FC 302.

## Parameter 30-20 High Starting Torque Time [s]

Table 1077: Parameter 30-20 High Starting Torque Time [s]

| 30-20 High Starting Torque Time [s] |                                 |                               |
|-------------------------------------|---------------------------------|-------------------------------|
| Default value: Size related         | Parameter type: Range, 0 - 60 s | Setup: All setups             |
| Conversion index: -2                | Data type: Uint16               | Change during operation: True |

Define for how long the increased high starting torque current defined in *parameter 30-21 High Starting Torque Current* should be applied.

## Parameter 30-21 High Starting Torque Current [%]

Table 1078: Parameter 30-21 High Starting Torque Current [%]

| 30-21 High Starting Torque Current [%] |                                   |                               |
|--|-----------------------------------|-------------------------------|
| Default value: Size related            | Parameter type: Range, 0 - 200.0% | Setup: All setups             |
| Conversion index: -1                   | Data type: Uint32                 | Change during operation: True |

Set the high starting current that should be applied for the time specified in *parameter 30-20 High Starting Torque Time*. The increased current will improve the starting torque and starting performance in demanding applications. The high starting torque current is valid for VVC+ and flux in speed open loop. The parameter can be used with the following motors:

- SPM
- IPM
- SynRM
- PMaSynRM

## Parameter 30-22 Locked Rotor Protection

Table 1079: Parameter 30-22 Locked Rotor Protection

| 30-22 Locked Rotor Protection |                        |                               |
|-------------------------------|------------------------|-------------------------------|
| Default value: Size related   | Parameter type: Option | Setup: All setups             |
| Conversion index: -           | Data type: Uint8       | Change during operation: True |

Available for PM motors only, in flux sensorless mode and VVC+ open-loop mode.

| Option | Name | Description  |
|--------|------|--|
| [0]    | Off  |  |
| [1]    | On   | Protects the motor from the locked rotor condition. The control algorithm detects a possible locked rotor condition in the motor and trips the drive to protect the motor. |

## Parameter 30-23 Locked Rotor Detection Time [s]

Table 1080: Parameter 30-23 Locked Rotor Detection Time [s]

| 30-23 Locked Rotor Detection Time [s] |                                   |                               |
|---------------------------------------|-----------------------------------|-------------------------------|
| Default value: Size related           | Parameter type: Range, 0.05 - 1 s | Setup: All setups             |
| Conversion index: -2                  | Data type: Uint8                  | Change during operation: True |

Time period for detecting the locked rotor condition. A low parameter value leads to faster detection.

## Parameter 30-24 Locked Rotor Detection Speed Error [%]

Table 1081: Parameter 30-24 Locked Rotor Detection Speed Error [%]

| 30-24 Locked Rotor Detection Speed Error [%] |                                 |                               |
|--|---------------------------------|-------------------------------|
| Default value: 25%                           | Parameter type: Range, 0 - 100% | Setup: All setups             |
| Conversion index: -1                         | Data type: Uint32               | Change during operation: True |

Detects locked rotor condition for SPMSM at high speed.

## Light-load detection

Light-load detection is a feature for lift application to ensure lift evacuation in a direction which requires the least energy (UPS capacity) during an emergency. When a light-load detection and start signal is received, the drive starts in the selected direction. After the delay in seconds specified in *parameter 30-26 Delay Before Measurements*, the drive integrates the current consumption within the time defined in *parameter 30-25 Measurement Duration*. After completing current integration for 1 direction, the drive starts in

the other direction and repeats the current integration. On comparing the 2 integrated currents, the lift evacuates in the direction which requires the least current.

#### Parameter 30-25 Measurement Duration

Table 1082: Parameter 30-25 Measurement Duration

| 30-25 Measurement Duration |   |                               |
|----------------------------|---|-------------------------------|
| Default value: 0.000 s     | Parameter type: Range, 0.000 - 10.000 s | Setup: All setups             |
| Conversion index: -3       | Data type: Uint32                       | Change during operation: True |

Duration of current integration measurement. The measurement is done in both directions. The direction with the lowest measurement value is selected by the drive.

#### Parameter 30-26 Delay Before Measurements

Table 1083: Parameter 30-26 Delay Before Measurements

| 30-26 Delay Before Measurements |   |                               |
|---------------------------------|---|-------------------------------|
| Default value: 0.000 s          | Parameter type: Range, 0.000 - 10.000 s | Setup: All setups             |
| Conversion index: 0             | Data type: Uint16                       | Change during operation: True |

Delay before current measurement. Allows to avoid mismatch in measurements caused by mechanical friction during opening of mechanical brakes.

#### Parameter 30-27 Light Load Speed [%]

Table 1084: Parameter 30-27 Light Load Speed [%]

| 30-27 Light Load Speed [%] |                                 |                               |
|----------------------------|---------------------------------|-------------------------------|
| Default value: 0%          | Parameter type: Range, 0 - 100% | Setup: All setups             |
| Conversion index: 0        | Data type: Uint16               | Change during operation: True |

Use this parameter when the light-load detection is active to define the speed during current measurement. Enter the reference speed during the light-load detection. The value is a percentage of nominal motor speed in *parameter 1-25 Motor Nominal Speed*. For standard asynchronous motors, the synchronous speed is used instead of *parameter 1-25 Motor Nominal Speed* due to slip.

#### Parameter 30-28 Evacuation Speed [%]

Table 1085: Parameter 30-28 Evacuation Speed [%]

| 30-28 Evacuation Speed [%] |                                 |                               |
|----------------------------|---------------------------------|-------------------------------|
| Default value: 0%          | Parameter type: Range, 0 - 100% | Setup: All setups             |
| Conversion index: 0        | Data type: Uint16               | Change during operation: True |

Speed for evacuation after detection of light-load direction.

#### Parameter 30-29 Ramp Time

Table 1086: Parameter 30-29 Ramp Time

| 30-29 Ramp Time             |                                      |                               |
|-----------------------------|--------------------------------------|-------------------------------|
| Default value: Size related | Parameter type: Range, 0.01 - 3600 s | Setup: All setups             |
| Conversion index: -2        | Data type: Uint32                    | Change during operation: True |

Ramp times during evacuation and measurement sequences.

### 5.23.3 30-5\* Unit Configuration

#### N O T I C E

The following parameter is only available in FC 302:

- *Parameter 30-50 Heat Sink Fan Mode*

Parameters in this group allow to configure the operation of internal units that communicate with the drive. The settings affect the behavior of hardware components inside the drive.

#### Parameter 30-50 Heat Sink Fan Mode

**Table 1087: Parameter 30-50 Heat Sink Fan Mode**

| 30-50 Heat Sink Fan Mode    |                        |                               |
|-----------------------------|------------------------|-------------------------------|
| Default value: Size related | Parameter type: Option | Setup: 2 setups               |
| Conversion index: -         | Data type: Uint8       | Change during operation: True |

Select how the heat sink fan responds to operating conditions. Use *parameter 14-52 Fan Control* to control the minimum fan speed.

| Option | Name              | Description   |
|--------|-------------------|---|
| [0]    | Simple profile    | The simple profile is a passive fan control based on the current temperature state of the drive. This option represents the classic operating behavior of fans. |
| [1]    | Reduced acoustics |   |
| [2]    | Standard          |   |
| [3]    | Cooler operation  |   |

### 5.23.4 30-7\* Power Low Monitor Protection

#### Parameter 30-70 Power Low Monitoring

**Table 1088: Parameter 30-70 Power Low Monitoring**

| 30-70 Power Low Monitoring  |                        |                               |
|-----------------------------|------------------------|-------------------------------|
| Default value: [0] Disabled | Parameter type: Option | Setup: All setups             |
| Conversion index: -         | Data type: Uint8       | Change during operation: True |

| Option | Name     | Description                                |
|--------|----------|--|
| [0]*   | Disabled | Disables the power-low monitoring feature. |
| [1]    | Enabled  | Enables the power-low monitoring feature.  |

#### Parameter 30-71 PLM Detection Time

**Table 1089: Parameter 30-71 PLM Detection Time**

| 30-71 PLM Detection Time |                                  |                               |
|--------------------------|----------------------------------|-------------------------------|
| Default value: 10 s      | Parameter type: Range, 4 - 100 s | Setup: All setups             |
| Conversion index: 0      | Data type: Uint16                | Change during operation: True |

Set the detection time window for power integration.

## Parameter 30-72 PLM Min. Speed

Table 1090: Parameter 30-72 PLM Min. Speed

| 30-72 PLM Min. Speed |                                 |                               |
|----------------------|---------------------------------|-------------------------------|
| Default value: 25%   | Parameter type: Range, 0 - 100% | Setup: All setups             |
| Conversion index: 0  | Data type: Uint16               | Change during operation: True |

This parameter shows the minimum detection speed above which the PLM algorithm is allowed to act. The speed is given in [%] relative to *parameter 1-25 Motor Nominal Speed*.

## Parameter 30-73 PLM Detection Factor

Table 1091: Parameter 30-73 PLM Detection Factor

| 30-73 PLM Detection Factor |                                |                               |
|----------------------------|--------------------------------|-------------------------------|
| Default value: 5           | Parameter type: Range, 2 - 100 | Setup: All setups             |
| Conversion index: 0        | Data type: Uint16              | Change during operation: True |

This parameter gives a detection sensitivity factor for the PLM feature - a copper loss multiplier. The PLM flags a blocked motor when the monitored energy throughout the time window is lower than the copper loss energy multiplied by this sensitivity parameter.

## 5.23.5 30-8\* Compatibility (I)

## N O T I C E

The following parameter is only available in FC 302:

- *Parameter 30-80 d-axis Inductance*

## Parameter 30-80 d-axis Inductance (Ld)

Table 1092: Parameter 30-80 d-axis Inductance (Ld)

| 30-80 d-axis Inductance (Ld) |  |                                |
|------------------------------|--|--------------------------------|
| Default value: Size related  | Parameter type: Range, 0.000 - 1000.000 mH | Setup: All setups              |
| Conversion index: -6         | Data type: Int32                           | Change during operation: False |

Enter the value of the d-axis inductance. Obtain the value from the permanent magnet motor datasheet. The d-axis inductance cannot be found by performing an AMA.

## Parameter 30-81 Brake Resistor (ohm)

Table 1093: Parameter 30-81 Brake Resistor (ohm)

| 30-81 Brake Resistor (ohm)  |  |                               |
|-----------------------------|--|-------------------------------|
| Default value: Size related | Parameter type: Range, 0.01 - 65535.00 ohm | Setup: 1 setup                |
| Conversion index: -2        | Data type: Uint32                          | Change during operation: True |

Set the brake resistor value in  $\Omega$ . This value is used for monitoring the power to the brake resistor in *parameter 2-13 Brake Power Monitoring*. This parameter is only active in drives with an integral dynamic brake.

## Parameter 30-83 Speed PID Proportional Gain

Table 1094: Parameter 30-83 Speed PID Proportional Gain

| 30-83 Speed PID Proportional Gain |                              |                               |
|-----------------------------------|------------------------------|-------------------------------|
| Default value: Size related       | Parameter type: Range, 0 - 1 | Setup: All setups             |
| Conversion index: -4              | Data type: Uint32            | Change during operation: True |

Enter the speed controller proportional gain. Quick control is obtained at high amplification. However, if amplification is too great, the process may become unstable.

## Parameter 30-84 Process PID Proportional Gain

Table 1095: Parameter 30-84 Process PID Proportional Gain

| 30-84 Process PID Proportional Gain |                               |                               |
|-------------------------------------|-------------------------------|-------------------------------|
| Default value: Size related         | Parameter type: Range, 0 - 10 | Setup: All setups             |
| Conversion index: -3                | Data type: Uint16             | Change during operation: True |

Enter the process controller proportional gain. Quick control is obtained at high amplification. However, if amplification is too great, the process may become unstable.

## Parameter 30-85 Motor Frequency

Table 1096: Parameter 30-85 Motor Frequency

| 30-85 Motor Frequency       |   |                                |
|-----------------------------|---|--------------------------------|
| Default value: Size related | Parameter type: Range, 20.0 - 1000.0 Hz | Setup: All setups              |
| Conversion index: -1        | Data type: Uint32                       | Change during operation: False |

## N O T I C E

Changing this parameter affects the settings of other parameters.

Select the motor frequency from the motor nameplate data.

## Parameter 30-88 System Inertia

Table 1097: Parameter 30-88 System Inertia

| Parameter 30-88 System Inertia |   |                                |
|--------------------------------|---|--------------------------------|
| Default value: Size related    | Parameter type: Range, 0.000000 - 2000.000000 [kgm <sup>2</sup> ] | Setup: All setups              |
| Conversion index: -6           | Data type: Uint32   | Change during operation: False |

## N O T I C E

This parameter is only available with software version 48.82 and newer.

Enables setting the system inertia with 6 decimals for small motors (*parameter 1-69 System Inertia* only has 4 decimals).

### 5.23.6 30-9\* Wifi LCP

Parameters for configuring the wireless LCP 103.



## Parameter 30-90 SSID

Table 1098: Parameter 30-90 SSID

| 30-90 SSID                  |   |                               |
|-----------------------------|---|-------------------------------|
| Default value: Size related | Parameter type: Range, 20.0 - 1000.0 Hz | Setup: 1 setup                |
| Conversion index: 0         | Data type: VisStr[32]                   | Change during operation: True |

Enter the wireless network name (SSID). The default value is: Danfoss\_<Serial number of the drive>. The serial number is in *parameter 15-51 Frequency Converter Serial Number*.

## Parameter 30-91 Channel

Table 1099: Parameter 30-91 Channel

| 30-91 Channel       |                               |                               |
|---------------------|-------------------------------|-------------------------------|
| Default value: 5    | Parameter type: Range, 1 - 11 | Setup: 1 setup                |
| Conversion index: 0 | Data type: Uint8              | Change during operation: True |

Enter the wireless channel number. The default channel number is 5. Change the channel number, if there is an interference from other wireless networks. Recommended channels: USA territory: 1, 6, 11. Europe: 1, 7, 13.

## Parameter 30-92 Password

Table 1100: Parameter 30-92 Password

| 30-92 Password              |                               |                               |
|-----------------------------|-------------------------------|-------------------------------|
| Default value: Size related | Parameter type: Range, 8 - 48 | Setup: 1 setup                |
| Conversion index: 0         | Data type: VisStr[48]         | Change during operation: True |

Enter the wireless network password. Password length: 8–48 characters.

## Parameter 30-97 Wifi Timeout Action

Table 1101: Parameter 30-97 Wifi Timeout Action

| 30-97 Wifi Timeout Action     |                        |                               |
|-------------------------------|------------------------|-------------------------------|
| Default value: [0] Do nothing | Parameter type: Option | Setup: 1 setup                |
| Conversion index: -           | Data type: Uint8       | Change during operation: True |

Select which action to execute if a local reference (hand-on mode) or a remote reference (auto-on mode) is set via the wireless connection and the connection is lost.

| Option | Name       | Description   |
|--------|------------|---|
| [0]*   | Do nothing | The drive does not do any extra actions.  |
| [1]    | Stop motor | The drive stops the motor (if the motor was started via a wireless connection). |

## Parameter 30-98 Remote SSID

Table 1102: Parameter 30-98 Remote SSID

| 30-98 Remote SSID           |                               |                               |
|-----------------------------|-------------------------------|-------------------------------|
| Default value: Size related | Parameter type: Range, 1 - 32 | Setup: 1 setup                |
| Conversion index: 0         | Data type: VisStr[32]         | Change during operation: True |

## Parameter 30-99 Wifi Network Mode

Table 1103: Parameter 30-99 Wifi Network Mode

| 30-99 Wifi Network Mode         |                        |                               |
|---------------------------------|------------------------|-------------------------------|
| Default value: [1] Access point | Parameter type: Option | Setup: 1 setup                |
| Conversion index: -             | Data type: Uint8       | Change during operation: True |

| Option | Name         | Description |
|--------|--------------|-------------|
| [0]    | None         |             |
| [1]*   | Access point |             |
| [2]    | Client       |             |

## 5.24 Parameter Group 31-\*\* Bypass Option

### N O T I C E

This parameter group is only available in FC 302.

## Parameter 31-00 Bypass Mode

Table 1104: Parameter 31-00 Bypass Mode

| 31-00 Bypass Mode        |                        |                               |
|--------------------------|------------------------|-------------------------------|
| Default value: [0] Drive | Parameter type: Option | Setup: All setups             |
| Conversion index: -      | Data type: Uint8       | Change during operation: True |

Select the bypass operating mode.

| Option | Name   | Description   |
|--------|--------|---|
| [0]*   | Drive  | The drive operates the motor.                           |
| [1]    | Bypass | The motor is operated at full speed during bypass mode. |

## Parameter 31-01 Bypass Start Time Delay

Table 1105: Parameter 31-01 Bypass Start Time Delay

| 31-01 Bypass Start Time Delay |                                 |                               |
|-------------------------------|---------------------------------|-------------------------------|
| Default Value: 30 s           | Parameter Type: Range, 0 - 60 s | Setup: All setups             |
| Conversion Index: 0           | Data Type: Uint16               | Change during operation: True |

Setting the time delay to pass from the bypass receives a run command until it starts the motor at full speed. A countdown timer shows the remaining time.

## Parameter 31-02 Bypass Trip Time Delay

Table 1106: Parameter 31-02 Bypass Trip Time Delay

| 31-02 Bypass Trip Time Delay |                                  |                               |
|------------------------------|----------------------------------|-------------------------------|
| Default value: 0 s           | Parameter type: Range, 0 - 300 s | Setup: All setups             |
| Conversion index: 0          | Data type: Uint16                | Change during operation: True |

Setting the time delay to pass from the drive experiences an alarm that stops it and until the motor is automatically switched to bypass control. If the delay is set to 0, a drive alarm does not automatically switch the motor to bypass control.

#### Parameter 31-03 Test Mode Activation

Table 1107: Parameter 31-03 Test Mode Activation

| 31-03 Test Mode Activation  |                        |                               |
|-----------------------------|------------------------|-------------------------------|
| Default value: [0] Disabled | Parameter type: Option | Setup: All setups             |
| Conversion index: -         | Data type: Uint8       | Change during operation: True |

| Option | Name     | Description  |
|--------|----------|--|
| [0]*   | Disabled | Test mode is disabled.   |
| [1]    | Enabled  | The motor runs in bypass while the drive can be tested into an open circuit. In this mode, keypad does not control start/stop of bypass. |

#### Parameter 31-10 Bypass Status Word

Table 1108: Parameter 31-10 Bypass Status Word

| 31-10 Bypass Status Word |                                  |                                |
|--------------------------|----------------------------------|--------------------------------|
| Default value: 0         | Parameter type: Range, 0 - 65535 | Setup: All setups              |
| Conversion index: 74     | Data type: V2                    | Change during operation: False |

View the status of the bypass as a hexadecimal value.

#### Parameter 31-11 Bypass Running Hours

Table 1109: Parameter 31-11 Bypass Running Hours

| 31-11 Bypass Running Hours |   |                                |
|----------------------------|---|--------------------------------|
| Default value: 0 h         | Parameter type: Range, 0 - 2147483647 h | Setup: All setups              |
| Conversion index: 74       | Data type: Uint32                       | Change during operation: False |

View the number of hours in which the motor has run in bypass mode. The counter can be reset in *parameter 15-07 Reset Running Hours Counter*. The value is saved when the drive is turned off.

#### Parameter 31-19 Remote Bypass Activation

Table 1110: Parameter 31-19 Remote Bypass Activation

| 31-19 Remote Bypass Activation |                        |                               |
|--------------------------------|------------------------|-------------------------------|
| Default value: [0] Disabled    | Parameter type: Option | Setup: 2 setups               |
| Conversion index: -            | Data type: Uint8       | Change during operation: True |

| Option | Name     | Description |
|--------|----------|-------------|
| [0]*   | Disabled |             |
| [1]    | Enabled  |             |

## 5.25 Parameter Group 32-\*\* MCO Basic Settings

Parameters in this group are available when VLT® Motion Control Option MCO 305 is installed in the drive. For information about the option, see the VLT® MCO Control Option MCO 305 Operating Guide.

## 5.25.1 32-0\* Encoder 2

## Parameter 32-00 Incremental Signal Type

Table 1111: Parameter 32-00 Incremental Signal Type

| 32-00 Incremental Signal Type     |                        |                               |
|-----------------------------------|------------------------|-------------------------------|
| Default value: [1] RS422 (5V TTL) | Parameter type: Option | Setup: 2 setups               |
| Conversion index: -               | Data type: Uint8       | Change during operation: True |

| Option | Name            | Description |
|--------|-----------------|-------------|
| [0]    | None            |             |
| [1]*   | RS422 (5V TTL)  |             |
| [2]    | Sinusoidal 1Vpp |             |
| [3]    | CAN encoder     |             |

## Parameter 32-01 Incremental Resolution

Table 1112: Parameter 32-01 Incremental Resolution

| 32-01 Incremental Resolution |                                       |                               |
|------------------------------|---------------------------------------|-------------------------------|
| Default value: 1024          | Parameter type: Range, 1 - 1073741823 | Setup: All setups             |
| Conversion index: 0          | Data type: Uint32                     | Change during operation: True |

Set the resolution of the incremental encoder connected to terminal X55. The maximum frequency must not exceed 410 kHz.

## Parameter 32-02 Absolute Protocol

Table 1113: Parameter 32-02 Absolute Protocol

| 32-02 Absolute Protocol |                        |                               |
|-------------------------|------------------------|-------------------------------|
| Default Value: [0] None | Parameter Type: Option | Setup: 2 setups               |
| Conversion Index: -     | Data Type: Uint8       | Change during operation: True |

| Option | Name            | Description |
|--------|-----------------|-------------|
| [0]*   | None            |             |
| [1]    | HIPERFACE       |             |
| [2]    | EnDat           |             |
| [4]    | SSI             |             |
| [5]    | SSI with filter |             |
| [6]    | BiSS-C          |             |
| [7]    | BiSS-B          |             |

Parameter 32-03 Absolute Resolution

Table 1114: Parameter 32-03 Absolute Resolution

| 32-03 Absolute Resolution |                                       |                               |
|---------------------------|---------------------------------------|-------------------------------|
| Default value: 8192       | Parameter type: Range, 0 - 1073741823 | Setup: All setups             |
| Conversion index: 0       | Data type: Uint32                     | Change during operation: True |

The encoder resolution is used for calculating velocity in RPM. Set the resolution of the absolute encoder connected to terminal X55 in positions per revolution. Find the encoder resolution on the encoder nameplate.

Parameter 32-04 Absolute Encoder Baudrate X55

Table 1115: Parameter 32-04 Absolute Encoder Baudrate X55

| 32-04 Absolute Encoder Baudrate X55 |                        |                               |
|-------------------------------------|------------------------|-------------------------------|
| Default Value: [4] 9600             | Parameter Type: Option | Setup: 2 setups               |
| Conversion Index: -                 | Data Type: Uint8       | Change during operation: True |

Select the baud rate of the attached encoder.

| Option | Name  | Description |
|--------|-------|-------------|
| [0]    | 600   |             |
| [1]    | 1200  |             |
| [2]    | 2400  |             |
| [3]    | 4800  |             |
| [4]*   | 9600  |             |
| [5]    | 19200 |             |
| [6]    | 38400 |             |

32-05 Absolute Encoder Data Length

Table 1116: 32-05 Absolute Encoder Data Length

| 32-05 Absolute Encoder Data Length |                               |                               |
|------------------------------------|-------------------------------|-------------------------------|
| Default value: 25                  | Parameter type: Range, 8 - 37 | Setup: 2 setups               |
| Conversion index: 0                | Data type: Uint8              | Change during operation: True |

Specify the number of data bits for the connected absolute encoder, see encoder datasheet. This specification is required for VLT® Motion Control Option MCO 305 and VLT® Motion Control Option MCO 302 to generate the correct number of clock bits.

Parameter 32-06 Absolute Encoder Clock Frequency

Table 1117: Parameter 32-06 Absolute Encoder Clock Frequency

| 32-06 Absolute Encoder Clock Frequency |  |                               |
|--|--|-------------------------------|
| Default value: 262                     | Parameter type: Range, 78.125 - 2000 kHz | Setup: 2 setups               |
| Conversion index: 3                    | Data type: Uint32                        | Change during operation: True |

Specifies the frequency of the absolute encoder clock signal generated by VLT® Motion Control Option MCO 305 and VLT® Motion Control Option MCO 302. Set a frequency appropriate for the connected encoder.

## Parameter 32-07 Absolute Encoder Clock Generation

Table 1118: Parameter 32-07 Absolute Encoder Clock Generation

| 32-07 Absolute Encoder Clock Generation |                        |                               |
|---|------------------------|-------------------------------|
| Default value: [1] On                   | Parameter type: Option | Setup: 2 setups               |
| Conversion index: -                     | Data type: Uint8       | Change during operation: True |

| Option | Name | Description   |
|--------|------|---|
| [0]    | Off  | Select [0] Off when more MCOs are connected to the same absolute encoder. Only 1 MCO is allowed to generate the clock signal when multiple MCOs are interconnected. |
| [1]*   | On   | Select [1] On when 1 MCO is connected to 1 absolute encoder.  |

## Parameter 32-08 Absolute Encoder Cable Length

Table 1119: Parameter 32-08 Absolute Encoder Cable Length

| 32-08 Absolute Encoder Cable Length |                                  |                               |
|-------------------------------------|----------------------------------|-------------------------------|
| Default value: 0                    | Parameter type: Range, 0 - 300 m | Setup: 2 setups               |
| Conversion index: 0                 | Data type: Uint16                | Change during operation: True |

Set the total cable length (in meters) to avoid that the absolute encoder (SSI) signals come out of synchronization due to signal delays caused by long encoder cables. VLT® Motion Control Option MCO 305 and VLT® Motion Control Option MCO 302 compensate for the cable delay when the cable length is known.

## Parameter 32-09 Encoder Monitoring

Table 1120: Parameter 32-09 Encoder Monitoring

| 32-09 Encoder Monitoring |                        |                               |
|--------------------------|------------------------|-------------------------------|
| Default value: [0] Off   | Parameter type: Option | Setup: 2 setups               |
| Conversion index: -      | Data type: Uint8       | Change during operation: True |

| Option | Name       | Description |
|--------|------------|-------------|
| [0]*   | Off        |             |
| [1]    | 3 channels |             |
| [2]    | 2 channels |             |
| [3]    | Warning    |             |
| [4]    | Alarm      |             |

## Parameter 32-10 Rotational Direction

Table 1121: Parameter 32-10 Rotational Direction

| 32-10 Rotational Direction   |                        |                               |
|------------------------------|------------------------|-------------------------------|
| Default value: [1] No action | Parameter type: Option | Setup: 2 setups               |
| Conversion index: -          | Data type: Uint8       | Change during operation: True |

Normally, a positive reference value brings about a positive change of the position. If this is not the case, the reference value can be reversed internally.

| Option | Name                | Description |
|--------|---------------------|-------------|
| [1]*   | No action           |             |
| [2]    | Reference reversed  |             |
| [3]    | User units reserved |             |
| [4]    | Uu and ref reversed |             |

## Parameter 32-11 User Unit Denominator

Table 1122: Parameter 32-11 User Unit Denominator

| 32-11 User Unit Denominator |                                       |                               |
|-----------------------------|---------------------------------------|-------------------------------|
| Default value: 1            | Parameter type: Range, 1 - 1073741823 | Setup: 2 setups               |
| Conversion index: 0         | Data type: Uint32                     | Change during operation: True |

All target positions are made in user units and are converted to quad-counts internally. By selecting scaling units, it is possible to work with any measurement unit (for example mm). This factor consists of a numerator and denominator.

## Parameter 32-12 User Units Numerator

Table 1123: Parameter 32-12 User Units Numerator

| 32-12 User Units Numerator |                                       |                               |
|----------------------------|---------------------------------------|-------------------------------|
| Default value: 1           | Parameter type: Range, 1 - 1073741823 | Setup: 2 setups               |
| Conversion index: 0        | Data type: Uint32                     | Change during operation: True |

All target positions are made in user units and are converted to quad-counts internally. By selecting scaling units, it is possible to work with any measurement unit (for example mm). This factor consists of a numerator and denominator.

## Parameter 32-13 Enc.2 Control

Table 1124: Parameter 32-13 Enc.2 Control

| 32-13 Enc.2 Control                 |                        |                               |
|-------------------------------------|------------------------|-------------------------------|
| Default value: [0] No soft changing | Parameter type: Option | Setup: 2 setups               |
| Conversion Index: -                 | Data Type: Uint8       | Change during operation: True |

Enables bump-less changing of feedback encoder in software while running and setting position to 0 without losing the actual position.

| Option | Name                                       | Description |
|--------|--|-------------|
| [0]*   | No soft changing                           |             |
| [1]    | Encoder soft changing enable               |             |
| [2]    | Soft zero setting enable                   |             |
| [3]    | Encoder soft changing and soft zero enable |             |

## Parameter 32-14 Enc.2 Node ID

Table 1125: Parameter 32-14 Enc.2 Node ID

| 32-14 Enc.2 Node ID |                                |                               |
|---------------------|--------------------------------|-------------------------------|
| Default value: 127  | Parameter type: Range, 1 - 127 | Setup: 2 setups               |
| Conversion index: 0 | Data type: Uint8               | Change during operation: True |

Enter the node ID for the feedback CAN encoder.  
Parameter 32-15 Enc.2 CAN Guard

Table 1126: Parameter 32-15 Enc.2 CAN Guard

| 32-15 Enc.2 CAN Guard  |                        |                               |
|------------------------|------------------------|-------------------------------|
| Default value: [0] Off | Parameter type: Option | Setup: 2 setups               |
| Conversion index: -    | Data type: Uint8       | Change during operation: True |

Select if the feedback CAN encoder guardians should be off or on.

| Option | Name | Description |
|--------|------|-------------|
| [0]*   | Off  |             |
| [1]    | On   |             |

### 5.25.2 32-3\* Encoder 1

Parameter 32-30 Incremental Signal Type

Table 1127: Parameter 32-30 Incremental Signal Type

| 32-30 Incremental Signal Type     |                        |                               |
|-----------------------------------|------------------------|-------------------------------|
| Default value: [1] RS422 (5V TTL) | Parameter type: Option | Setup: 2 setups               |
| Conversion index: -               | Data type: Uint8       | Change during operation: True |

| Option | Name           | Description |
|--------|----------------|-------------|
| [0]    | None           |             |
| [1]*   | RS422 (5V TTL) |             |
| [3]    | CAN encoder    |             |

Parameter 32-31 Incremental Resolution

Table 1128: Parameter 32-31 Incremental Resolution

| 32-31 Incremental Resolution |                                       |                               |
|------------------------------|---------------------------------------|-------------------------------|
| Default value: 1024          | Parameter type: Range, 1 - 1073741823 | Setup: 2 setups               |
| Conversion index: 0          | Data type: Uint32                     | Change during operation: True |

Set the resolution of the incremental encoder connected to terminal X56. The maximum frequency must not exceed 410 kHz.

Parameter 32-32 Absolute Protocol

Table 1129: Parameter 32-32 Absolute Protocol

| 32-32 Absolute Protocol |                        |                               |
|-------------------------|------------------------|-------------------------------|
| Default value: [0] None | Parameter type: Option | Setup: 2 setups               |
| Conversion index: -     | Data type: Uint8       | Change during operation: True |

| Option | Name      | Description |
|--------|-----------|-------------|
| [0]*   | None      |             |
| [1]    | HIPERFACE |             |
| [2]    | EnDat     |             |



| Option | Name            | Description |
|--------|-----------------|-------------|
| [4]    | SSI             |             |
| [5]    | SSI with filter |             |
| [6]    | BiSS-C          |             |
| [7]    | BiSS-B          |             |

Parameter 32-33 Absolute Resolution

Table 1130: Parameter 32-33 Absolute Resolution

| 32-33 Absolute Resolution |                                       |                               |
|---------------------------|---------------------------------------|-------------------------------|
| Default value: 8192       | Parameter type: Range, 0 - 1073741823 | Setup: 2 setups               |
| Conversion index: 0       | Data type: Uint32                     | Change during operation: True |

The encoder resolution is used for calculating velocity in RPM. Set the resolution of the absolute encoder connected to terminal X56 in positions per revolution. Find the encoder resolution on the encoder nameplate.

Parameter 32-35 Absolute Encoder Data Length

Table 1131: Parameter 32-35 Absolute Encoder Data Length

| 32-35 Absolute Encoder Data Length |                               |                               |
|------------------------------------|-------------------------------|-------------------------------|
| Default value: 25                  | Parameter type: Range, 8 - 37 | Setup: 2 setups               |
| Conversion index: 0                | Data type: Uint8              | Change during operation: True |

Specify the number of data bits for the connected absolute encoder, see encoder datasheet. This specification is required for VLT® Motion Control Option MCO 305 and VLT® Motion Control Option MCO 302 to generate the correct number of clock bits.

Parameter 32-36 Absolute Encoder Clock Frequency

Table 1132: Parameter 32-36 Absolute Encoder Clock Frequency

| 32-36 Absolute Encoder Clock Frequency |  |                               |
|--|--|-------------------------------|
| Default value: 262                     | Parameter type: Range, 78.125 - 2000 kHz | Setup: 2 setups               |
| Conversion index: 3                    | Data type: Uint32                        | Change during operation: True |

Specifies the frequency of the absolute encoder clock signal generated by VLT® Motion Control Option MCO 305 and VLT® Motion Control Option MCO 302. Set a frequency appropriate for the connected encoder.

Parameter 32-37 Absolute Encoder Clock Generation

Table 1133: Parameter 32-37 Absolute Encoder Clock Generation

| 32-37 Absolute Encoder Clock Generation |                        |                               |
|---|------------------------|-------------------------------|
| Default value: [1] On                   | Parameter type: Option | Setup: 2 setups               |
| Conversion index: -                     | Data type: Uint8       | Change during operation: True |

| Option | Name | Description   |
|--------|------|---|
| [0]    | Off  | Select [0] Off when more MCOs are connected to the same absolute encoder. Only 1 MCO is allowed to generate the clock signal when multiple MCOs are interconnected. |
| [1]*   | On   | Select [1] On when 1 MCO is connected to 1 absolute encoder.  |

## Parameter 32-38 Absolute Encoder Cable Length

Table 1134: Parameter 32-38 Absolute Encoder Cable Length

| 32-38 Absolute Encoder Cable Length |                                  |                               |
|-------------------------------------|----------------------------------|-------------------------------|
| Default Value: 0                    | Parameter Type: Range, 0 - 300 m | Setup: 2 setups               |
| Conversion Index: 0                 | Data Type: Uint16                | Change during operation: True |

Set the total cable length (in meters) to avoid that the absolute encoder (SSI) signals come out of synchronization due to signal delays caused by long encoder cables. VLT® Motion Control Option MCO 305 and VLT® Motion Control Option MCO 302 compensate for the cable delay when the cable length is known.

## Parameter 32-39 Encoder Monitoring

Table 1135: Parameter 32-39 Encoder Monitoring

| 32-39 Encoder Monitoring |                        |                               |
|--------------------------|------------------------|-------------------------------|
| Default value: [0] Off   | Parameter type: Option | Setup: 2 setups               |
| Conversion index: -      | Data type: Uint8       | Change during operation: True |

| Option | Name       | Description |
|--------|------------|-------------|
| [0]*   | Off        |             |
| [1]    | 3 channels |             |
| [2]    | 2 channels |             |
| [3]    | Warning    |             |
| [4]    | Alarm      |             |

## Parameter 32-40 Encoder Termination

Table 1136: Parameter 32-40 Encoder Termination

| 32-40 Encoder Termination    |                        |                               |
|------------------------------|------------------------|-------------------------------|
| Default value: [1] No action | Parameter type: Option | Setup: 2 setups               |
| Conversion index: -          | Data type: Uint8       | Change during operation: True |

| Option | Name                | Description |
|--------|---------------------|-------------|
| [1]*   | No action           |             |
| [2]    | Reference reversed  |             |
| [3]    | User units reserved |             |
| [4]    | Uu and ref reversed |             |

## Parameter 32-43 Enc.1 Control

Table 1137: Parameter 32-43 Enc.1 Control

| 32-43 Enc.1 Control                 |                        |                               |
|-------------------------------------|------------------------|-------------------------------|
| Default value: [0] No soft changing | Parameter type: Option | Setup: 2 setups               |
| Conversion index: -                 | Data type: Uint8       | Change during operation: True |

| Option | Name                                       | Description |
|--------|--|-------------|
| [0]*   | No soft changing                           |             |
| [1]    | Encoder soft changing enable               |             |
| [2]    | Soft zero setting enable                   |             |
| [4]    | Encoder soft changing and soft zero enable |             |

## Parameter 32-44 Enc.1 Node ID

Table 1138: Parameter 32-44 Enc.1 Node ID

| 32-44 Enc.1 Node ID |                                |                               |
|---------------------|--------------------------------|-------------------------------|
| Default value: 127  | Parameter type: Range, 1 - 127 | Setup: 2 setups               |
| Conversion index: 0 | Data type: Uint8               | Change during operation: True |

Enter the node ID for the feedback CAN encoder.

## Parameter 32-45 Enc.1 CAN Guard

Table 1139: Parameter 32-45 Enc.1 CAN Guard

| 32-45 Enc.1 CAN Guard  |                        |                               |
|------------------------|------------------------|-------------------------------|
| Default value: [0] Off | Parameter type: Option | Setup: 2 setups               |
| Conversion index: -    | Data type: Uint8       | Change during operation: True |

Select if the feedback CAN encoder guardians should be off or on.

| Option | Name | Description |
|--------|------|-------------|
| [0]*   | Off  |             |
| [1]    | On   |             |

## 5.25.3 32-5\* Feedback Source

## Parameter 32-50 Source Slave

Table 1140: Parameter 32-50 Source Slave

| 32-50 Source Slave               |                        |                               |
|----------------------------------|------------------------|-------------------------------|
| Default value: [2] Encoder 2 X55 | Parameter type: Option | Setup: 2 setups               |
| Conversion index: -              | Data type: Uint8       | Change during operation: True |

| Option | Name          | Description |
|--------|---------------|-------------|
| [1]    | Encoder 1 X56 |             |
| [2]*   | Encoder 2 X55 |             |
| [3]    | Motor control |             |

## Parameter 32-51 MCO 302 Last Will

Table 1141: Parameter 32-51 MCO 302 Last Will

| 32-51 MCO 302 Last Will |                        |                               |
|-------------------------|------------------------|-------------------------------|
| Default value: [1] Trip | Parameter type: Option | Setup: 2 setups               |
| Conversion index: -     | Data type: Uint8       | Change during operation: True |

| Option | Name          | Description |
|--------|---------------|-------------|
| [0]    | No action     |             |
| [1]*   | Trip          |             |
| [2]    | Coming action |             |

## Parameter 32-52 Source Master

Table 1142: Parameter 32-52 Source Master

| 32-52 Source Master              |                        |                               |
|----------------------------------|------------------------|-------------------------------|
| Default value: [1] Encoder 1 X56 | Parameter type: Option | Setup: 2 setups               |
| Conversion index: -              | Data type: Uint8       | Change during operation: True |

| Option | Name          | Description |
|--------|---------------|-------------|
| [1]*   | Encoder 1 X56 |             |
| [2]    | Encoder 2 X55 |             |
| [3]    | Motor control |             |

## 5.25.4 32-6\* PID Controller

## Parameter 32-60 Proportional Factor

Table 1143: Parameter 32-60 Proportional Factor

| 32-60 Proportional Factor |                                   |                               |
|---------------------------|-----------------------------------|-------------------------------|
| Default value: 30         | Parameter type: Range, 0 - 100000 | Setup: 2 setups               |
| Conversion index: 0       | Data type: Uint32                 | Change during operation: True |

The proportional factor indicates the linear correction factor with which the deviation between the current set and actual position is evaluated. The motor speed is then corrected accordingly.

## Parameter 32-61 Derivative Factor

Table 1144: Parameter 32-61 Derivative Factor

| 32-61 Derivative Factor |                                   |                               |
|-------------------------|-----------------------------------|-------------------------------|
| Default value: 0        | Parameter type: Range, 0 - 100000 | Setup: 2 setups               |
| Conversion index: 0     | Data type: Uint32                 | Change during operation: True |

The derivative value is the correction factor with which the changing speed of a motor position error is evaluated. The derivative value prevents overshoot due to a high P-share and dampens the system.

## Parameter 32-62 Integral Factor

Table 1145: Parameter 32-62 Integral Factor

| 32-62 Integral Factor |                                   |                               |
|-----------------------|-----------------------------------|-------------------------------|
| Default value: 0      | Parameter type: Range, 0 - 100000 | Setup: 2 setups               |
| Conversion index: 0   | Data type: Uint32                 | Change during operation: True |

The integral factor is the weighting factor with which, at time  $n$ , the sum of all motor position errors are evaluated.

## Parameter 32-63 Limit Value for Integral Sum

Table 1146: Parameter 32-63 Limit Value for Integral Sum

| 32-63 Limit Value for Integral Sum |                                 |                               |
|------------------------------------|---------------------------------|-------------------------------|
| Default value: 1000                | Parameter type: Range, 0 - 1000 | Setup: 2 setups               |
| Conversion index: 0                | Data type: Uint16               | Change during operation: True |

This parameter limits the integral sum to avoid instability and PID wind-up if a feedback error occurs.

## Parameter 32-64 PID Bandwidth

Table 1147: Parameter 32-64 PID Bandwidth

| 32-64 PID Bandwidth |                                 |                               |
|---------------------|---------------------------------|-------------------------------|
| Default value: 1000 | Parameter type: Range, 0 - 1000 | Setup: 2 setups               |
| Conversion index: 0 | Data type: Uint16               | Change during operation: True |

The value 1000 means that the PID filter can output the full command value. For a Bandwidth of 500 only 50 % of the set value is output.

## Parameter 32-65 Velocity Feed-Forward

Table 1148: Parameter 32-65 Velocity Feed-Forward

| 32-65 Velocity Feed-Forward |                                   |                               |
|-----------------------------|-----------------------------------|-------------------------------|
| Default value: 0            | Parameter type: Range, 0 - 100000 | Setup: 2 setups               |
| Conversion index: 0         | Data type: Uint32                 | Change during operation: True |

Velocity Feed-forward is a scaling factor that is multiplied with the derivative of the setpoint position (the velocity of the setpoint). Use this function to get a more dynamic controller.

## Parameter 32-66 Acceleration Feed-Forward

Table 1149: Parameter 32-66 Acceleration Feed-Forward

| 32-66 Acceleration Feed-Forward |                                   |                               |
|---------------------------------|-----------------------------------|-------------------------------|
| Default value: 0                | Parameter type: Range, 0 - 100000 | Setup: 2 setups               |
| Conversion index: 0             | Data type: Uint32                 | Change during operation: True |

Acceleration Feed-forward is multiplied with the 2<sup>nd</sup> derivative of the setpoint position (the acceleration of the setpoint), and the result is added to the control signal. Use this function to give an extra boost during acceleration.

## Parameter 32-67 Max. Tolerated Position Error

Table 1150: Parameter 32-67 Max. Tolerated Position Error

| 32-67 Max. Tolerated Position Error |                                       |                               |
|-------------------------------------|---------------------------------------|-------------------------------|
| Default value: 20000                | Parameter type: Range, 1 - 1073741823 | Setup: 2 setups               |
| Conversion index: 0                 | Data type: Uint32                     | Change during operation: True |

This parameter defines the maximum error allowed between the actual position and the calculated command position. If the actual error exceeds the value set in this parameter, the position control fault alarm is triggered.

## Parameter 32-68 Reverse Behavior for Slave

Table 1151: Parameter 32-68 Reverse Behavior for Slave

| 32-68 Reverse Behavior for Slave     |                        |                               |
|--------------------------------------|------------------------|-------------------------------|
| Default value: [0] Reversing allowed | Parameter type: Option | Setup: 2 setups               |
| Conversion index: -                  | Data type: Uint8       | Change during operation: True |

| Option | Name              | Description |
|--------|-------------------|-------------|
| [0]*   | Reversing allowed |             |
| [1]    | Rev. when master  |             |
| [2]    | Reversing blocked |             |

## Parameter 32-69 Sampling Time for PID Control

Table 1152: Parameter 32-69 Sampling Time for PID Control

| 32-69 Sampling Time for PID Control |                                 |                               |
|-------------------------------------|---------------------------------|-------------------------------|
| Default value: 1                    | Parameter type: Range, 1 - 1000 | Setup: 2 setups               |
| Conversion index: -3                | Data type: Uint16               | Change during operation: True |

Sample time of the PID controller. Increase the time if the controller is unstable because of a low-resolution feedback signal or very high load inertia.

## Parameter 32-70 Scan Time for Profile Generator

Table 1153: Parameter 32-70 Scan Time for Profile Generator

| 32-70 Scan Time for Profile Generator |                                 |                               |
|---------------------------------------|---------------------------------|-------------------------------|
| Default value: 1                      | Parameter type: Range, 1 - 5 ms | Setup: 2 setups               |
| Conversion index: -3                  | Data type: Uint8                | Change during operation: True |

Sample time of the profile generator. Increasing the time speeds up the execution of the application program execution. However, it also reduces control performance so the sample time should not be increased too much if dynamic control is required.

## Parameter 32-71 Size of the Control Window (Activation)

Table 1154: Parameter 32-71 Size of the Control Window (Activation)

| 32-71 Size of the Control Window (Activation) |                                       |                               |
|---|---------------------------------------|-------------------------------|
| Default value: 0                              | Parameter type: Range, 0 - 1073741823 | Setup: 2 setups               |
| Conversion index: 0                           | Data type: Uint32                     | Change during operation: True |

Parameter 32-72 Size of the Control Window (Deactiv.)

Table 1155: Parameter 32-72 Size of the Control Window (Deactiv.)

| 32-72 Size of the Control Window (Deactiv.) |                                       |                               |
|---|---------------------------------------|-------------------------------|
| Default value: 0                            | Parameter type: Range, 0 - 1073741823 | Setup: 2 setups               |
| Conversion index: 0                         | Data type: Uint32                     | Change during operation: True |

Parameter 32-74 Position Error Filter Time

Table 1156: Parameter 32-74 Position Error Filter Time

| 32-74 Position Error Filter Time |                                     |                               |
|----------------------------------|-------------------------------------|-------------------------------|
| Default value: 0                 | Parameter type: Range, 0 - 10000 ms | Setup: 2 setups               |
| Conversion index: -3             | Data type: Int16                    | Change during operation: True |

The position error is only activated if the position error value set in *parameter 32-67 Max. Tolerated Position Error* is exceeded for a time longer than the setting in this parameter.

### 5.25.5 32-8\* Velocity & Accel.

Parameter 32-80 Maximum Velocity (Encoder)

Table 1157: Parameter 32-80 Maximum Velocity (Encoder)

| 32-80 Maximum Velocity (Encoder) |                                       |                               |
|----------------------------------|---------------------------------------|-------------------------------|
| Default value: 1500              | Parameter type: Range, 1 - 100000 RPM | Setup: 2 setups               |
| Conversion index: 67             | Data type: Uint32                     | Change during operation: True |

This parameter defines the maximum velocity in RPM during motion control.

Parameter 32-81 Shortest Ramp

Table 1158: Parameter 32-81 Shortest Ramp

| 32-81 Shortest Ramp |                                       |                               |
|---------------------|---------------------------------------|-------------------------------|
| Default value: 1    | Parameter type: Range, 0.001 - 3600 s | Setup: 2 setups               |
| Conversion index: 0 | Data type: Uint32                     | Change during operation: True |

This parameter defines the quick-stop ramp time from the maximum allowed velocity to 0 for motion control.

Parameter 32-82 Ramp Type

Table 1159: Parameter 32-82 Ramp Type

| 32-82 Ramp Type           |                        |                               |
|---------------------------|------------------------|-------------------------------|
| Default value: [0] Linear | Parameter type: Option | Setup: 2 setups               |
| Conversion index: -       | Data type: Uint8       | Change during operation: True |

| Option | Name              | Description |
|--------|-------------------|-------------|
| [0]*   | Linear            |             |
| [1]    | S-ramp const jerk |             |
| [2]    | S-ramp const time |             |

## Parameter 32-83 Velocity Resolution

Table 1160: Parameter 32-83 Velocity Resolution

| 32-83 Velocity Resolution |                                       |                               |
|---------------------------|---------------------------------------|-------------------------------|
| Default value: 100        | Parameter type: Range, 1 - 1073741823 | Setup: 2 setups               |
| Conversion index: 0       | Data type: Uint32                     | Change during operation: True |

## Parameter 32-84 Default Velocity

Table 1161: Parameter 32-84 Default Velocity

| 32-84 Default Velocity |                                       |                               |
|------------------------|---------------------------------------|-------------------------------|
| Default value: 50      | Parameter type: Range, 1 - 1073741823 | Setup: 2 setups               |
| Conversion index: 0    | Data type: Uint32                     | Change during operation: True |

## Parameter 32-85 Default Acceleration

Table 1162: Parameter 32-85 Default Acceleration

| 32-85 Default Acceleration |                                       |                               |
|----------------------------|---------------------------------------|-------------------------------|
| Default value: 50          | Parameter type: Range, 1 - 1073741823 | Setup: 2 setups               |
| Conversion index: 0        | Data type: Uint32                     | Change during operation: True |

## Parameter 32-86 Acc. Up for Limited Jerk

Table 1163: Parameter 32-86 Acc. Up for Limited Jerk

| 32-86 Acc. Up for Limited Jerk |  |                               |
|--------------------------------|--|-------------------------------|
| Default value: 100             | Parameter type: Range, 0 - 1073741823 ms | Setup: 2 setups               |
| Conversion index: -3           | Data type: Uint32                        | Change during operation: True |

## Parameter 32-87 Acc. Down for Limited Jerk

Table 1164: Parameter 32-87 Acc. Down for Limited Jerk

| 32-87 Acc. Down for Limited Jerk |  |                               |
|----------------------------------|--|-------------------------------|
| Default value: 0                 | Parameter type: Range, 0 - 1073741823 ms | Setup: 2 setups               |
| Conversion index: -3             | Data type: Uint32                        | Change during operation: True |

## Parameter 32-88 Dec. Up for Limited Jerk

Table 1165: Parameter 32-88 Dec. Up for Limited Jerk

| 32-88 Dec. Up for Limited Jerk |  |                               |
|--------------------------------|--|-------------------------------|
| Default value: 0               | Parameter type: Range, 0 - 1073741823 ms | Setup: 2 setups               |
| Conversion index: -3           | Data type: Uint32                        | Change during operation: True |

## Parameter 32-88 Dec. Down for Limited Jerk

Table 1166: Parameter 32-89 Dec. Down for Limited Jerk

| 32-89 Dec. Down for Limited Jerk |  |                               |
|----------------------------------|--|-------------------------------|
| Default value: 0                 | Parameter type: Range, 0 - 1073741823 ms | Setup: 2 setups               |
| Conversion index: -3             | Data type: Uint32                        | Change during operation: True |



### 5.25.6 32-9\* Development

#### Parameter 32-90 Debug Source

Table 1167: Parameter 32-90 Debug Source

| 32-90 Debug Source             |                        |                               |
|--------------------------------|------------------------|-------------------------------|
| Default value: [0] Controlcard | Parameter type: Option | Setup: 2 setups               |
| Conversion index: -            | Data type: Uint8       | Change during operation: True |

| Option | Name        | Description |
|--------|-------------|-------------|
| [0]*   | Controlcard |             |
| [1]    | Option      |             |

### 5.26 Parameter Group 33-\*\*\* MCO Adv. Settings

Parameters in this group are available when VLT® Motion Control Option MCO 305 is installed in the drive. For information about the option, see the VLT® Motion Control Option MCO 305 Operating Instructions.

#### 5.26.1 33-0\* Home Motion

##### Parameter 33-00 Force HOME

Table 1168: Parameter 33-00 Force HOME

| 33-00 Force HOME                   |                        |                               |
|------------------------------------|------------------------|-------------------------------|
| Default value: [0] Home not forced | Parameter type: Option | Setup: 2 setups               |
| Conversion index: -                | Data type: Uint8       | Change during operation: True |

| Option | Name            | Description |
|--------|-----------------|-------------|
| [0]*   | Home not forced |             |
| [1]    | Home forced     |             |

Parameter 33-01 Zero Point Offset from Home Pos.

Table 1169: Parameter 33-01 Zero Point Offset from Home Pos.

| 33-01 Zero Point Offset from Home Pos. |   |                               |
|--|---|-------------------------------|
| Default value: 0                       | Parameter type: Range, -1073741824 - 1073741823 | Setup: 2 setups               |
| Conversion index: 0                    | Data type: Int32                                | Change during operation: True |

Use this parameter to set an offset of 0 (home position) compared to the position after homing.

Parameter 33-02 Ramp for Home Motion

Table 1170: Parameter 33-02 Ramp for Home Motion

| 33-02 Ramp for Home Motion |  |                               |
|----------------------------|--|-------------------------------|
| Default value: 10          | Parameter type: Range, -1 - 1073741823 | Setup: 2 setups               |
| Conversion index: 0        | Data type: Uint32                      | Change during operation: True |

This parameter defines the ramp time (in ms) from standstill to the value set in *parameter 32-80 Maximum Allowed Velocity*.

## Parameter 33-03 Velocity for Home Motion

Table 1171: Parameter 33-03 Velocity for Home Motion

| 33-03 Velocity for Home Motion |                                     |                               |
|--------------------------------|-------------------------------------|-------------------------------|
| Default value: 10              | Parameter type: Range, Size related | Setup: 2 setups               |
| Conversion index: 0            | Data type: Int32                    | Change during operation: True |

This parameter defines the velocity of homing. It must not exceed *parameter 32-80 Maximum Allowed Velocity*.

## Parameter 33-04 Behavior During Home Motion

Table 1172: Parameter 33-04 Behavior During Home Motion

| 33-04 Behavior During Home Motion   |                        |                               |
|-------------------------------------|------------------------|-------------------------------|
| Default value: [0] Revers and index | Parameter type: Option | Setup: 2 setups               |
| Conversion index: -                 | Data type: Uint8       | Change during operation: True |

Define the behavior when the home switch is found: Reversing without index (0 pulse) search, or forwarding without index search.

| Option | Name              | Description |
|--------|-------------------|-------------|
| [0]*   | Revers and index  |             |
| [1]    | Revers no index   |             |
| [2]    | Forward and index |             |
| [3]    | Forward no index  |             |

## 5.26.2 33-1\* Synchronization

## Parameter 33-10 Sync Factor Master

Table 1173: Parameter 33-10 Sync Factor Master

| 33-10 Sync Factor Master |   |                               |
|--------------------------|---|-------------------------------|
| Default value: 1         | Parameter type: Range, -1073741824 - 1073741823 | Setup: 2 setups               |
| Conversion index: 0      | Data type: Int32                                | Change during operation: True |

## Parameter 33-11 Sync Factor Slave

Table 1174: Parameter 33-11 Sync Factor Slave

| 33-11 Sync Factor Slave |   |                               |
|-------------------------|---|-------------------------------|
| Default value: 1        | Parameter type: Range, -1073741824 - 1073741823 | Setup: 2 setups               |
| Conversion index: 0     | Data type: Int32                                | Change during operation: True |

## Parameter 33-12 Position Offset for Synchronization

Table 1175: Parameter 33-12 Position Offset for Synchronization

| 33-12 Position Offset for Synchronization |                                     |                               |
|---|-------------------------------------|-------------------------------|
| Default value: 0                          | Parameter type: Range, Size related | Setup: 2 setups               |
| Conversion index: 0                       | Data type: Int32                    | Change during operation: True |

Parameter 33-13 Accuracy Window for Position Sync.

Table 1176: Parameter 33-13 Accuracy Window for Position Sync.

| 33-13 Accuracy Window for Position Sync. |   |                               |
|--|---|-------------------------------|
| Default value: 1000                      | Parameter type: Range, -1073741824 - 1073741823 | Setup: 2 setups               |
| Conversion index: 0                      | Data type: Int32                                | Change during operation: True |

Parameter 33-14 Relative Slave Velocity Limit

Table 1177: Parameter 33-14 Relative Slave Velocity Limit

| 33-14 Relative Slave Velocity Limit |                                 |                               |
|-------------------------------------|---------------------------------|-------------------------------|
| Default value: 0                    | Parameter type: Range, 0 - 100% | Setup: 2 setups               |
| Conversion index: 0                 | Data type: UInt8                | Change during operation: True |

Parameter 33-15 Marker Number for Master

Table 1178: Parameter 33-15 Marker Number for Master

| 33-15 Marker Number for Master |                                  |                               |
|--------------------------------|----------------------------------|-------------------------------|
| Default value: 1               | Parameter type: Range, 1 - 10000 | Setup: 2 setups               |
| Conversion index: 0            | Data type: UInt16                | Change during operation: True |

Parameter 33-16 Marker Number for Slave

Table 1179: Parameter 33-16 Marker Number for Slave

| 33-16 Marker Number for Slave |                                  |                               |
|-------------------------------|----------------------------------|-------------------------------|
| Default value: 1              | Parameter type: Range, 1 - 10000 | Setup: 2 setups               |
| Conversion index: 0           | Data type: UInt16                | Change during operation: True |

Parameter 33-17 Master Marker Distance

Table 1180: Parameter 33-17 Master Marker Distance

| 33-17 Master Marker Distance |                                       |                               |
|------------------------------|---------------------------------------|-------------------------------|
| Default value: 4096          | Parameter type: Range, 0 - 1073741823 | Setup: 2 setups               |
| Conversion index: 0          | Data type: UInt32                     | Change during operation: True |

Parameter 33-18 Slave Marker Distance

Table 1181: Parameter 33-18 Slave Marker Distance

| 33-18 Slave Marker Distance |                                       |                               |
|-----------------------------|---------------------------------------|-------------------------------|
| Default value: 4096         | Parameter type: Range, 0 - 1073741823 | Setup: 2 setups               |
| Conversion index: 0         | Data type: UInt32                     | Change during operation: True |

Parameter 33-20 Slave Marker Type

Table 1182: Parameter 33-20 Slave Marker Type

| 33-20 Slave Marker Type               |                        |                               |
|---------------------------------------|------------------------|-------------------------------|
| Default value: [0] Encoder Z positive | Parameter type: Option | Setup: 2 setups               |
| Conversion index: -                   | Data type: UInt8       | Change during operation: True |

| Option | Name                 | Description |
|--------|----------------------|-------------|
| [0]*   | Encoder Z positive   |             |
| [1]    | Encoder Z negative   |             |
| [2]    | Ext. marker positive |             |
| [3]    | Ext. marker negative |             |

## Parameter 33-21 Master Marker Tolerance Window

Table 1183: Parameter 33-21 Master Marker Tolerance Window

| 33-21 Master Marker Tolerance Window |                                       |                               |
|--------------------------------------|---------------------------------------|-------------------------------|
| Default value: 0                     | Parameter type: Range, 0 - 1073741823 | Setup: 2 setups               |
| Conversion index: 0                  | Data type: Uint32                     | Change during operation: True |

## Parameter 33-22 Slave Marker Tolerance Window

Table 1184: Parameter 33-22 Slave Marker Tolerance Window

| 33-22 Slave Marker Tolerance Window |                                       |                               |
|-------------------------------------|---------------------------------------|-------------------------------|
| Default value: 0                    | Parameter type: Range, 0 - 1073741823 | Setup: 2 setups               |
| Conversion index: 0                 | Data type: Uint32                     | Change during operation: True |

## Parameter 33-23 Start Behavior for Marker Sync

Table 1185: Parameter 33-23 Start Behavior for Marker Sync

| 33-23 Start Behavior for Marker Sync |                        |                               |
|--------------------------------------|------------------------|-------------------------------|
| Default value: [0] Leading marker    | Parameter type: Option | Setup: 2 setups               |
| Conversion index: -                  | Data type: Uint16      | Change during operation: True |

| Option | Name               | Description |
|--------|--------------------|-------------|
| [0]*   | Leading marker     |             |
| [1]    | Following marker   |             |
| [2]    | Closest marker     |             |
| [3]    | Master vel/lbg mrk |             |
| [4]    | Master vel/flw mrk |             |
| [5]    | Master vel/cls mrk |             |
| [6]    | Next 2 markers     |             |
| [7]    | Start with poly5   |             |
| [1000] | Ldg mrk late offs  |             |
| [1001] | Flw mrk late offs  |             |
| [1002] | Cls mark late offs |             |
| [1003] | Mv/lbg mrk/lt off  |             |
| [1004] | Mv/flw mrk/lt off  |             |

| Option | Name              | Description |
|--------|-------------------|-------------|
| [1005] | Mv/cls mrk/lt off |             |
| [1006] | Next 2 mrk/lt off |             |
| [1007] | Poly5/late offs   |             |
| [2000] | Camstart mast mrk |             |

## Parameter 33-24 Marker Number for Fault

Table 1186: Parameter 33-24 Marker Number for Fault

| 33-24 Marker Number for Fault |                                  |                               |
|-------------------------------|----------------------------------|-------------------------------|
| Default value: 10             | Parameter type: Range, 0 - 10000 | Setup: 2 setups               |
| Conversion index: 0           | Data type: Uint16                | Change during operation: True |

## Parameter 33-26 Velocity Filter

Table 1187: Parameter 33-26 Velocity Filter

| 33-26 Velocity Filter |  |                               |
|-----------------------|--|-------------------------------|
| Default value: 0      | Parameter type: Range, -1073741824 - 1073741823 us | Setup: 2 setups               |
| Conversion index: -6  | Data type: Int32                                   | Change during operation: True |

## Parameter 33-27 Offset Filter Time

Table 1188: Parameter 33-27 Offset Filter Time

| 33-27 Offset Filter Time |  |                               |
|--------------------------|--|-------------------------------|
| Default value: 0         | Parameter type: Range, 0 - 1073741823 ms | Setup: 2 setups               |
| Conversion index: -3     | Data type: Uint32                        | Change during operation: True |

## Parameter 33-28 Marker Filter Configuration

Table 1189: Parameter 33-28 Marker Filter Configuration

| 33-28 Marker Filter Configuration  |                        |                               |
|------------------------------------|------------------------|-------------------------------|
| Default value: [0] Marker filter 1 | Parameter type: Option | Setup: 2 setups               |
| Conversion index: -                | Data type: Uint8       | Change during operation: True |

| Option | Name                 | Description |
|--------|----------------------|-------------|
| [0]*   | Marker filter 1      |             |
| [1]    | Marker filter 2      |             |
| [2]    | Correction syncfact  |             |
| [4]    | Correction time      |             |
| [16]   | No marker dist. corr |             |

## Parameter 33-29 Filter Time for Marker Filter

Table 1190: Parameter 33-29 Filter Time for Marker Filter

| 33-29 Filter Time for Marker Filter |  |                               |
|-------------------------------------|--|-------------------------------|
| Default value: 0                    | Parameter type: Range, -1073741824 - 1073741823 ms | Setup: 2 setups               |
| Conversion index: -3                | Data type: Int32                                   | Change during operation: True |

## Parameter 33-30 Maximum Marker Correction

Table 1191: Parameter 33-30 Maximum Marker Correction

| 33-30 Maximum Marker Correction |                                       |                               |
|---------------------------------|---------------------------------------|-------------------------------|
| Default value: 0                | Parameter type: Range, 0 - 1073741823 | Setup: 2 setups               |
| Conversion index: 0             | Data type: Uint32                     | Change during operation: True |

## Parameter 33-31 Synchronization Type

Table 1192: Parameter 33-31 Synchronization Type

| 33-31 Synchronization Type  |                        |                               |
|-----------------------------|------------------------|-------------------------------|
| Default value: [0] Standard | Parameter type: Option | Setup: 2 setups               |
| Conversion index: -         | Data type: Uint8       | Change during operation: True |

| Option | Name       | Description |
|--------|------------|-------------|
| [0]*   | Standard   |             |
| [1]    | Look ahead |             |

## Parameter 33-32 Feed Forward Velocity Adaptation

Table 1193: Parameter 33-32 Feed Forward Velocity Adaptation

| 33-32 Feed Forward Velocity Adaptation |                                       |                               |
|--|---------------------------------------|-------------------------------|
| Default value: 0                       | Parameter type: Range, 0 - 1073741823 | Setup: 2 setups               |
| Conversion index: 0                    | Data type: Uint32                     | Change during operation: True |

## Parameter 33-33 Velocity Filter Window

Table 1194: Parameter 33-33 Velocity Filter Window

| 33-33 Velocity Filter Window |                                       |                               |
|------------------------------|---------------------------------------|-------------------------------|
| Default value: 0             | Parameter type: Range, 0 - 1073741823 | Setup: 2 setups               |
| Conversion index: 0          | Data type: Uint32                     | Change during operation: True |

## Parameter 33-34 Slave Marker Filter Time

Table 1195: Parameter 33-34 Slave Marker Filter Time

| 33-34 Slave Marker Filter Time |  |                               |
|--------------------------------|--|-------------------------------|
| Default value: 0               | Parameter type: Range, 0 - 1073741823 ms | Setup: 2 setups               |
| Conversion index: -3           | Data type: Uint32                        | Change during operation: True |

### 5.26.3 33-4\* Limit Handling

#### Parameter 33-40 Behavior atEnd Limit Switch

Table 1196: Parameter 33-40 Behavior atEnd Limit Switch

| 33-40 Behavior atEnd Limit Switch     |                        |                               |
|---------------------------------------|------------------------|-------------------------------|
| Default value: [0] Call error handler | Parameter type: Option | Setup: 2 setups               |
| Conversion index: -                   | Data type: Uint8       | Change during operation: True |

| Option | Name               | Description |
|--------|--------------------|-------------|
| [0]*   | Call error handler |             |
| [1]    | Controlled stop    |             |

#### Parameter 33-41 Negative Software End Limit

Table 1197: Parameter 33-41 Negative Software End Limit

| 33-41 Negative Software End Limit |   |                               |
|-----------------------------------|---|-------------------------------|
| Default value: -500000            | Parameter type: Range, -1073741824 - 1073741823 | Setup: 2 setups               |
| Conversion index: 0               | Data type: Int32                                | Change during operation: True |

This parameter is active only during positioning if *parameter 33-42 Negative Software Limit Active* is set to [1] Active. When *parameter 34-50 Actual Position* reaches below the negative software limit set in this parameter, a position control fault alarm is reported.

#### Parameter 33-42 Positive Software End Limit

Table 1198: Parameter 33-42 Positive Software End Limit

| 33-42 Positive Software End Limit |   |                               |
|-----------------------------------|---|-------------------------------|
| Default value: 500000             | Parameter type: Range, -1073741824 - 1073741823 | Setup: 2 setups               |
| Conversion index: 0               | Data type: Int32                                | Change during operation: True |

This parameter is active only during positioning if *parameter 33-42 Negative Software Limit Active* is set to [1] Active. When *parameter 34-50 Actual Position* reaches below the negative software limit set in this parameter, a position control fault alarm is reported.

#### Parameter 33-42 Positive Software End Limit

Table 1199: Parameter 33-42 Positive Software End Limit

| 33-42 Positive Software End Limit |   |                               |
|-----------------------------------|---|-------------------------------|
| Default value: 500000             | Parameter type: Range, -1073741824 - 1073741823 | Setup: 2 setups               |
| Conversion index: 0               | Data type: Int32                                | Change during operation: True |

This parameter is active only during positioning if *parameter 33-42 Negative Software Limit Active* is set to [1] Active. When *parameter 34-50 Actual Position* reaches below the negative software limit set in this parameter, a position control fault alarm is reported.

#### Parameter 33-43 Negative Software End Limit Active

Table 1200: Parameter 33-43 Negative Software End Limit Active

| 33-43 Negative Software End Limit Active |                        |                               |
|--|------------------------|-------------------------------|
| Default value: [0] Inactive              | Parameter type: Option | Setup: 2 setups               |
| Conversion index: -                      | Data type: Uint8       | Change during operation: True |

| Option | Name     | Description |
|--------|----------|-------------|
| [0]*   | Inactive |             |
| [1]    | Active   |             |

## Parameter 33-44 Positive Software End Limit Active

Table 1201: Parameter 33-44 Positive Software End Limit Active

| 33-44 Positive Software End Limit Active |                        |                               |
|--|------------------------|-------------------------------|
| Default value: [0] Inactive              | Parameter type: Option | Setup: 2 setups               |
| Conversion index: -                      | Data type: Uint8       | Change during operation: True |

When this parameter is set to active, the drive continuously checks whether the target position is above the positive software limit. If the position is outside the limit, an error is issued and the drive control is switched off.

| Option | Name     | Description |
|--------|----------|-------------|
| [0]*   | Inactive |             |
| [1]    | Active   |             |

## Parameter 33-45 Time in Target Window

Table 1202: Parameter 33-45 Time in Target Window

| 33-45 Time in Target Window |                                  |                               |
|-----------------------------|----------------------------------|-------------------------------|
| Default value: 0            | Parameter type: Range, 0 - 10 ms | Setup: 2 setups               |
| Conversion index: -3        | Data type: Uint8                 | Change during operation: True |

## Parameter 33-46 Target Window LimitValue

Table 1203: Parameter 33-46 Target Window LimitValue

| 33-46 Target Window LimitValue |                                     |                               |
|--------------------------------|-------------------------------------|-------------------------------|
| Default value: 1               | Parameter type: Range, 1 - 10000 ms | Setup: 2 setups               |
| Conversion index: 0            | Data type: Uint16                   | Change during operation: True |

## Parameter 33-47 Size of Target Window

Table 1204: Parameter 33-47 Size of Target Window

| 33-47 Size of Target Window |                                     |                               |
|-----------------------------|-------------------------------------|-------------------------------|
| Default value: 0            | Parameter type: Range, 0 - 10000 ms | Setup: 2 setups               |
| Conversion index: 0         | Data type: Uint16                   | Change during operation: True |

Defines the size of the target window with user unit. A position is only viewed as reached when the actual position is within this window.



## 5.26.4 33-5\* I/O Configuration

## Parameter 33-50 Terminal X57/1 Digital Input

Table 1205: Parameter 33-50 Terminal X57/1 Digital Input

| 33-50 Terminal X57/1 Digital Input |                        |                               |
|------------------------------------|------------------------|-------------------------------|
| Default value: [0] No function     | Parameter type: Option | Setup: 2 setups               |
| Conversion index: -                | Data type: Uint8       | Change during operation: True |

| Option | Name                | Description |
|--------|---------------------|-------------|
| [0]*   | No function         |             |
| [1]    | Home switch no      |             |
| [2]    | Home switch nc      |             |
| [3]    | Neg. end switch no  |             |
| [4]    | Neg. end switch nc  |             |
| [5]    | Posi. end switch no |             |
| [6]    | Posi. end switch nc |             |
| [7]    | Error clear no      |             |
| [8]    | Error clear nc      |             |
| [9]    | Break prog. exe no  |             |
| [10]   | Break prog. exe nc  |             |
| [11]   | Cont. prog. exe no  |             |
| [12]   | Cont. prog. exe nc  |             |
| [13]   | Start prog. exe no  |             |
| [14]   | Start prog. exe nc  |             |
| [15]   | Program select      |             |

## Parameter 33-51 Terminal X57/2 Digital Input

Table 1206: Parameter 33-51 Terminal X57/2 Digital Input

| 33-51 Terminal X57/2 Digital Input |                        |                               |
|------------------------------------|------------------------|-------------------------------|
| Default value: [0] No function     | Parameter type: Option | Setup: 2 setups               |
| Conversion index: -                | Data type: Uint8       | Change during operation: True |

| Option | Name               | Description |
|--------|--------------------|-------------|
| [0]*   | No function        |             |
| [1]    | Home switch no     |             |
| [2]    | Home switch nc     |             |
| [3]    | Neg. end switch no |             |
| [4]    | Neg. end switch nc |             |

| Option | Name                | Description |
|--------|---------------------|-------------|
| [5]    | Posi. end switch no |             |
| [6]    | Posi. end switch nc |             |
| [7]    | Error clear no      |             |
| [8]    | Error clear nc      |             |
| [9]    | Break prog. exe no  |             |
| [10]   | Break prog. exe nc  |             |
| [11]   | Cont. prog. exe no  |             |
| [12]   | Cont. prog. exe nc  |             |
| [13]   | Start prog. exe no  |             |
| [14]   | Start prog. exe nc  |             |
| [15]   | Program select      |             |

## Parameter 33-52 Terminal X57/3 Digital Input

Table 1207: Parameter 33-52 Terminal X57/3 Digital Input

| 33-52 Terminal X57/3 Digital Input |                        |                               |
|------------------------------------|------------------------|-------------------------------|
| Default value: [0] No function     | Parameter type: Option | Setup: 2 setups               |
| Conversion index: -                | Data type: Uint8       | Change during operation: True |

| Option | Name                | Description |
|--------|---------------------|-------------|
| [0]*   | No function         |             |
| [1]    | Home switch no      |             |
| [2]    | Home switch nc      |             |
| [3]    | Neg. end switch no  |             |
| [4]    | Neg. end switch nc  |             |
| [5]    | Posi. end switch no |             |
| [6]    | Posi. end switch nc |             |
| [7]    | Error clear no      |             |
| [8]    | Error clear nc      |             |
| [9]    | Break prog. exe no  |             |
| [10]   | Break prog. exe nc  |             |
| [11]   | Cont. prog. exe no  |             |
| [12]   | Cont. prog. exe nc  |             |

| Option | Name               | Description |
|--------|--------------------|-------------|
| [13]   | Start prog. exe no |             |
| [14]   | Start prog. exe nc |             |
| [15]   | Program select     |             |

## Parameter 33-53 Terminal X57/4 Digital Input

Table 1208: Parameter 33-53 Terminal X57/4 Digital Input

| 33-53 Terminal X57/4 Digital Input |                        |                               |
|------------------------------------|------------------------|-------------------------------|
| Default value: [0] No function     | Parameter type: Option | Setup: 2 setups               |
| Conversion index: -                | Data type: Uint8       | Change during operation: True |

| Option | Name                | Description |
|--------|---------------------|-------------|
| [0]*   | No function         |             |
| [1]    | Home switch no      |             |
| [2]    | Home switch nc      |             |
| [3]    | Neg. end switch no  |             |
| [4]    | Neg. end switch nc  |             |
| [5]    | Posi. end switch no |             |
| [6]    | Posi. end switch nc |             |
| [7]    | Error clear no      |             |
| [8]    | Error clear nc      |             |
| [9]    | Break prog. exe no  |             |
| [10]   | Break prog. exe nc  |             |
| [11]   | Cont. prog. exe no  |             |
| [12]   | Cont. prog. exe nc  |             |
| [13]   | Start prog. exe no  |             |
| [14]   | Start prog. exe nc  |             |
| [15]   | Program select      |             |

## Parameter 33-54 Terminal X57/5 Digital Input

Table 1209: Parameter 33-54 Terminal X57/5 Digital Input

| 33-54 Terminal X57/5 Digital Input |                        |                               |
|------------------------------------|------------------------|-------------------------------|
| Default value: [0] No function     | Parameter type: Option | Setup: 2 setups               |
| Conversion index: -                | Data type: Uint8       | Change during operation: True |

| Option | Name                | Description |
|--------|---------------------|-------------|
| [0]*   | No function         |             |
| [1]    | Home switch no      |             |
| [2]    | Home switch nc      |             |
| [3]    | Neg. end switch no  |             |
| [4]    | Neg. end switch nc  |             |
| [5]    | Posi. end switch no |             |
| [6]    | Posi. end switch nc |             |
| [7]    | Error clear no      |             |
| [8]    | Error clear nc      |             |
| [9]    | Break prog. exe no  |             |
| [10]   | Break prog. exe nc  |             |
| [11]   | Cont. prog. exe no  |             |
| [12]   | Cont. prog. exe nc  |             |
| [13]   | Start prog. exe no  |             |
| [14]   | Start prog. exe nc  |             |
| [15]   | Program select      |             |

## Parameter 33-55 Terminal X57/6 Digital Input

Table 1210: Parameter 33-55 Terminal X57/6 Digital Input

| 33-55 Terminal X57/6 Digital Input |                        |                               |
|------------------------------------|------------------------|-------------------------------|
| Default value: [0] No function     | Parameter type: Option | Setup: 2 setups               |
| Conversion index: -                | Data type: Uint8       | Change during operation: True |

| Option | Name                | Description |
|--------|---------------------|-------------|
| [0]*   | No function         |             |
| [1]    | Home switch no      |             |
| [2]    | Home switch nc      |             |
| [3]    | Neg. end switch no  |             |
| [4]    | Neg. end switch nc  |             |
| [5]    | Posi. end switch no |             |
| [6]    | Posi. end switch nc |             |
| [7]    | Error clear no      |             |
| [8]    | Error clear nc      |             |
| [9]    | Break prog. exe no  |             |

| Option | Name               | Description |
|--------|--------------------|-------------|
| [10]   | Break prog. exe nc |             |
| [11]   | Cont. prog. exe no |             |
| [12]   | Cont. prog. exe nc |             |
| [13]   | Start prog. exe no |             |
| [14]   | Start prog. exe nc |             |
| [15]   | Program select     |             |

## Parameter 33-56 Terminal X57/7 Digital Input

Table 1211: Parameter 33-56 Terminal X57/7 Digital Input

| 33-56 Terminal X57/7 Digital Input |                        |                               |
|------------------------------------|------------------------|-------------------------------|
| Default value: [0] No function     | Parameter type: Option | Setup: 2 setups               |
| Conversion index: -                | Data type: Uint8       | Change during operation: True |

| Option | Name                | Description |
|--------|---------------------|-------------|
| [0]*   | No function         |             |
| [1]    | Home switch no      |             |
| [2]    | Home switch nc      |             |
| [3]    | Neg. end switch no  |             |
| [4]    | Neg. end switch nc  |             |
| [5]    | Posi. end switch no |             |
| [6]    | Posi. end switch nc |             |
| [7]    | Error clear no      |             |
| [8]    | Error clear nc      |             |
| [9]    | Break prog. exe no  |             |
| [10]   | Break prog. exe nc  |             |
| [11]   | Cont. prog. exe no  |             |
| [12]   | Cont. prog. exe nc  |             |
| [13]   | Start prog. exe no  |             |
| [14]   | Start prog. exe nc  |             |
| [15]   | Program select      |             |

## Parameter 33-57 Terminal X57/8 Digital Input

Table 1212: Parameter 33-57 Terminal X57/8 Digital Input

| 33-57 Terminal X57/8 Digital Input |                        |                               |
|------------------------------------|------------------------|-------------------------------|
| Default value: [0] No function     | Parameter type: Option | Setup: 2 setups               |
| Conversion index: -                | Data type: Uint8       | Change during operation: True |

| Option | Name                | Description |
|--------|---------------------|-------------|
| [0]*   | No function         |             |
| [1]    | Home switch no      |             |
| [2]    | Home switch nc      |             |
| [3]    | Neg. end switch no  |             |
| [4]    | Neg. end switch nc  |             |
| [5]    | Posi. end switch no |             |
| [6]    | Posi. end switch nc |             |
| [7]    | Error clear no      |             |
| [8]    | Error clear nc      |             |
| [9]    | Break prog. exe no  |             |
| [10]   | Break prog. exe nc  |             |
| [11]   | Cont. prog. exe no  |             |
| [12]   | Cont. prog. exe nc  |             |
| [13]   | Start prog. exe no  |             |
| [14]   | Start prog. exe nc  |             |
| [15]   | Program select      |             |

## Parameter 33-58 Terminal X57/9 Digital Input

Table 1213: Parameter 33-58 Terminal X57/9 Digital Input

| 33-58 Terminal X57/9 Digital Input |                        |                               |
|------------------------------------|------------------------|-------------------------------|
| Default value: [0] No function     | Parameter type: Option | Setup: 2 setups               |
| Conversion index: -                | Data type: Uint8       | Change during operation: True |

| Option | Name                | Description |
|--------|---------------------|-------------|
| [0]*   | No function         |             |
| [1]    | Home switch no      |             |
| [2]    | Home switch nc      |             |
| [3]    | Neg. end switch no  |             |
| [4]    | Neg. end switch nc  |             |
| [5]    | Posi. end switch no |             |
| [6]    | Posi. end switch nc |             |
| [7]    | Error clear no      |             |
| [8]    | Error clear nc      |             |
| [9]    | Break prog. exe no  |             |

| Option | Name               | Description |
|--------|--------------------|-------------|
| [10]   | Break prog. exe nc |             |
| [11]   | Cont. prog. exe no |             |
| [12]   | Cont. prog. exe nc |             |
| [13]   | Start prog. exe no |             |
| [14]   | Start prog. exe nc |             |
| [15]   | Program select     |             |

## Parameter 33-59 Terminal X57/10 Digital Input

Table 1214: Parameter 33-59 Terminal X57/10 Digital Input

| 33-59 Terminal X57/10 Digital Input |                        |                               |
|-------------------------------------|------------------------|-------------------------------|
| Default value: [0] No function      | Parameter type: Option | Setup: 2 setups               |
| Conversion index: -                 | Data type: Uint8       | Change during operation: True |

| Option | Name                | Description |
|--------|---------------------|-------------|
| [0]*   | No function         |             |
| [1]    | Home switch no      |             |
| [2]    | Home switch nc      |             |
| [3]    | Neg. end switch no  |             |
| [4]    | Neg. end switch nc  |             |
| [5]    | Posi. end switch no |             |
| [6]    | Posi. end switch nc |             |
| [7]    | Error clear no      |             |
| [8]    | Error clear nc      |             |
| [9]    | Break prog. exe no  |             |
| [10]   | Break prog. exe nc  |             |
| [11]   | Cont. prog. exe no  |             |
| [12]   | Cont. prog. exe nc  |             |
| [13]   | Start prog. exe no  |             |
| [14]   | Start prog. exe nc  |             |
| [15]   | Program select      |             |

## Parameter 33-60 Terminal X59/1 and X59/2 Mode

Table 1215: Parameter 33-60 Terminal X59/1 and X59/2 Mode

| 33-60 Terminal X59/1 and X59/2 Mode |                        |                                |
|-------------------------------------|------------------------|--------------------------------|
| Default value: [1] Output           | Parameter type: Option | Setup: 2 setups                |
| Conversion index: -                 | Data type: Uint8       | Change during operation: False |

| Option | Name   | Description |
|--------|--------|-------------|
| [0]    | Input  |             |
| [1]*   | Output |             |

Parameter 33-61 Terminal X59/1 Digital Input

Table 1216: Parameter 33-61 Terminal X59/1 Digital Input

| 33-61 Terminal X59/1 Digital Input |                        |                               |
|------------------------------------|------------------------|-------------------------------|
| Default value: [0] No function     | Parameter type: Option | Setup: 2 setups               |
| Conversion index: -                | Data type: Uint8       | Change during operation: True |

| Option | Name                | Description |
|--------|---------------------|-------------|
| [0]*   | No function         |             |
| [1]    | Home switch no      |             |
| [2]    | Home switch nc      |             |
| [3]    | Neg. end switch no  |             |
| [4]    | Neg. end switch nc  |             |
| [5]    | Posi. end switch no |             |
| [6]    | Posi. end switch nc |             |
| [7]    | Error clear no      |             |
| [8]    | Error clear nc      |             |
| [9]    | Break prog. exe no  |             |
| [10]   | Break prog. exe nc  |             |
| [11]   | Cont. prog. exe no  |             |
| [12]   | Cont. prog. exe nc  |             |
| [13]   | Start prog. exe no  |             |
| [14]   | Start prog. exe nc  |             |
| [15]   | Program select      |             |

Parameter 33-62 Terminal X59/2 Digital Input

Table 1217: Parameter 33-62 Terminal X59/2 Digital Input

| 33-62 Terminal X59/2 Digital Input |                        |                               |
|------------------------------------|------------------------|-------------------------------|
| Default value: [0] No function     | Parameter type: Option | Setup: 2 setups               |
| Conversion index: -                | Data type: Uint8       | Change during operation: True |

| Option | Name           | Description |
|--------|----------------|-------------|
| [0]*   | No function    |             |
| [1]    | Home switch no |             |



| Option | Name                | Description |
|--------|---------------------|-------------|
| [2]    | Home switch nc      |             |
| [3]    | Neg. end switch no  |             |
| [4]    | Neg. end switch nc  |             |
| [5]    | Posi. end switch no |             |
| [6]    | Posi. end switch nc |             |
| [7]    | Error clear no      |             |
| [8]    | Error clear nc      |             |
| [9]    | Break prog. exe no  |             |
| [10]   | Break prog. exe nc  |             |
| [11]   | Cont. prog. exe no  |             |
| [12]   | Cont. prog. exe nc  |             |
| [13]   | Start prog. exe no  |             |
| [14]   | Start prog. exe nc  |             |
| [15]   | Program select      |             |

## Parameter 33-63 Terminal X59/2 Digital Output

Table 1218: Parameter 33-63 Terminal X59/1 Digital Output

| 33-63 Terminal X59/1 Digital Output |                        |                               |
|-------------------------------------|------------------------|-------------------------------|
| Default value: [0] No function      | Parameter type: Option | Setup: 2 setups               |
| Conversion index: -                 | Data type: Uint8       | Change during operation: True |

| Option | Name             | Description |
|--------|------------------|-------------|
| [0]*   | No function      |             |
| [1]    | Moving no        |             |
| [2]    | Moving nc        |             |
| [3]    | Error no         |             |
| [4]    | Error nc         |             |
| [5]    | Brake control no |             |
| [6]    | Brake control nc |             |

## Parameter 33-64 Terminal X59/2 Digital Output

Table 1219: Parameter 33-64 Terminal X59/2 Digital Output

| 33-64 Terminal X59/2 Digital Output |                        |                               |
|-------------------------------------|------------------------|-------------------------------|
| Default value: [0] No function      | Parameter type: Option | Setup: 2 setups               |
| Conversion index: -                 | Data type: Uint8       | Change during operation: True |

| Option | Name             | Description |
|--------|------------------|-------------|
| [0]*   | No function      |             |
| [1]    | Moving no        |             |
| [2]    | Moving nc        |             |
| [3]    | Error no         |             |
| [4]    | Error nc         |             |
| [5]    | Brake control no |             |
| [6]    | Brake control nc |             |

## Parameter 33-65 Terminal X59/3 Digital Output

Table 1220: Parameter 33-65 Terminal X59/3 Digital Output

| 33-65 Terminal X59/3 Digital Output |                        |                               |
|-------------------------------------|------------------------|-------------------------------|
| Default value: [0] No function      | Parameter type: Option | Setup: 2 setups               |
| Conversion index: -                 | Data type: Uint8       | Change during operation: True |

| Option | Name             | Description |
|--------|------------------|-------------|
| [0]*   | No function      |             |
| [1]    | Moving no        |             |
| [2]    | Moving nc        |             |
| [3]    | Error no         |             |
| [4]    | Error nc         |             |
| [5]    | Brake control no |             |
| [6]    | Brake control nc |             |

## Parameter 33-66 Terminal X59/4 Digital Output

Table 1221: Parameter 33-66 Terminal X59/4 Digital Output

| 33-66 Terminal X59/4 Digital Output |                        |                               |
|-------------------------------------|------------------------|-------------------------------|
| Default value: [0] No function      | Parameter type: Option | Setup: 2 setups               |
| Conversion index: -                 | Data type: Uint8       | Change during operation: True |

| Option | Name        | Description |
|--------|-------------|-------------|
| [0]*   | No function |             |
| [1]    | Moving no   |             |
| [2]    | Moving nc   |             |
| [3]    | Error no    |             |

| Option | Name             | Description |
|--------|------------------|-------------|
| [4]    | Error nc         |             |
| [5]    | Brake control no |             |
| [6]    | Brake control nc |             |

## Parameter 33-67 Terminal X59/5 Digital Output

Table 1222: Parameter 33-67 Terminal X59/5 Digital Output

| 33-67 Terminal X59/5 Digital Output |                        |                               |
|-------------------------------------|------------------------|-------------------------------|
| Default value: [0] No function      | Parameter type: Option | Setup: 2 setups               |
| Conversion index: -                 | Data type: Uint8       | Change during operation: True |

| Option | Name             | Description |
|--------|------------------|-------------|
| [0]*   | No function      |             |
| [1]    | Moving no        |             |
| [2]    | Moving nc        |             |
| [3]    | Error no         |             |
| [4]    | Error nc         |             |
| [5]    | Brake control no |             |
| [6]    | Brake control nc |             |

## Parameter 33-68 Terminal X59/6 Digital Output

Table 1223: Parameter 33-68 Terminal X59/6 Digital Output

| 33-68 Terminal X59/6 Digital Output |                        |                               |
|-------------------------------------|------------------------|-------------------------------|
| Default value: [0] No function      | Parameter type: Option | Setup: 2 setups               |
| Conversion index: -                 | Data type: Uint8       | Change during operation: True |

| Option | Name             | Description |
|--------|------------------|-------------|
| [0]*   | No function      |             |
| [1]    | Moving no        |             |
| [2]    | Moving nc        |             |
| [3]    | Error no         |             |
| [4]    | Error nc         |             |
| [5]    | Brake control no |             |
| [6]    | Brake control nc |             |

## Parameter 33-69 Terminal X59/7 Digital Output

Table 1224: Parameter 33-69 Terminal X59/7 Digital Output

| 33-69 Terminal X59/7 Digital Output |                        |                               |
|-------------------------------------|------------------------|-------------------------------|
| Default value: [0] No function      | Parameter type: Option | Setup: 2 setups               |
| Conversion index: -                 | Data type: Uint8       | Change during operation: True |

| Option | Name             | Description |
|--------|------------------|-------------|
| [0]*   | No function      |             |
| [1]    | Moving no        |             |
| [2]    | Moving nc        |             |
| [3]    | Error no         |             |
| [4]    | Error nc         |             |
| [5]    | Brake control no |             |
| [6]    | Brake control nc |             |

## Parameter 33-70 Terminal X59/8 Digital Output

Table 1225: Parameter 33-70 Terminal X59/8 Digital Output

| 33-70 Terminal X59/8 Digital Output |                        |                               |
|-------------------------------------|------------------------|-------------------------------|
| Default value: [0] No function      | Parameter type: Option | Setup: 2 setups               |
| Conversion index: -                 | Data type: Uint8       | Change during operation: True |

| Option | Name             | Description |
|--------|------------------|-------------|
| [0]*   | No function      |             |
| [1]    | Moving no        |             |
| [2]    | Moving nc        |             |
| [3]    | Error no         |             |
| [4]    | Error nc         |             |
| [5]    | Brake control no |             |
| [6]    | Brake control nc |             |

## 5.26.5 33-8\* Global Parameters

## Parameter 33-80 Activated Program Number

Table 1226: Parameter 33-80 Activated Program Number

| 33-80 Activated Program Number |                                 |                               |
|--------------------------------|---------------------------------|-------------------------------|
| Default value: -1              | Parameter type: Range, -1 - 127 | Setup: 2 setups               |
| Conversion index: 0            | Data type: Int8                 | Change during operation: True |

## Parameter 33-81 Power-up State

Table 1227: Parameter 33-81 Power-up State

| 33-81 Power-up State        |                        |                               |
|-----------------------------|------------------------|-------------------------------|
| Default value: [1] Motor on | Parameter type: Option | Setup: 2 setups               |
| Conversion index: -         | Data type: Uint8       | Change during operation: True |

| Option | Name      | Description |
|--------|-----------|-------------|
| [0]    | Motor off |             |
| [1]*   | Motor on  |             |

## Parameter 33-82 Drive Status Monitoring

Table 1228: Parameter 33-82 Drive Status Monitoring

| 33-82 Drive Status Monitoring |                        |                               |
|-------------------------------|------------------------|-------------------------------|
| Default value: [1] On         | Parameter type: Option | Setup: 2 setups               |
| Conversion index: -           | Data type: Uint8       | Change during operation: True |

| Option | Name | Description |
|--------|------|-------------|
| [0]    | Off  |             |
| [1]*   | On   |             |

## Parameter 33-83 Behavior afterError

Table 1229: Parameter 33-83 Behavior afterError

| 33-83 Behavior afterError |                        |                               |
|---------------------------|------------------------|-------------------------------|
| Default value: [0] Coast  | Parameter type: Option | Setup: 2 setups               |
| Conversion index: -       | Data type: Uint8       | Change during operation: True |

| Option | Name               | Description |
|--------|--------------------|-------------|
| [0]*   | Coast              |             |
| [1]    | Coast and brake    |             |
| [2]    | Controlled stop    |             |
| [3]    | Contr.stop + brake |             |
| [5]    | Only errorhandler  |             |

## Parameter 33-84 Behavior afterEsc.

Table 1230: Parameter 33-84 Behavior afterEsc.

| 33-84 Behavior afterEsc.           |                        |                               |
|------------------------------------|------------------------|-------------------------------|
| Default value: [0] Controlled stop | Parameter type: Option | Setup: 2 setups               |
| Conversion index: -                | Data type: Uint8       | Change during operation: True |

| Option | Name                 | Description |
|--------|----------------------|-------------|
| [0]*   | Controlled stop      |             |
| [1]    | Contr. stop + outp=0 |             |
| [2]    | Contr. stop + outp=1 |             |

## Parameter 33-85 MCO Supplied by External 24VDC

Table 1231: Parameter 33-85 MCO Supplied by External 24VDC

| 33-85 MCO Supplied by External 24VDC |                        |                               |
|--------------------------------------|------------------------|-------------------------------|
| Default value: [0] No                | Parameter type: Option | Setup: 2 setups               |
| Conversion index: -                  | Data type: Uint8       | Change during operation: True |

| Option | Name | Description |
|--------|------|-------------|
| [0]*   | No   |             |
| [1]    | Yes  |             |

## Parameter 33-86 Terminal at Alarm

Table 1232: Parameter 33-86 Terminal at Alarm

| 33-86 Terminal at Alarm    |                        |                               |
|----------------------------|------------------------|-------------------------------|
| Default value: [0] Relay 1 | Parameter type: Option | Setup: 2 setups               |
| Conversion index: -        | Data type: Uint8       | Change during operation: True |

| Option | Name                       | Description |
|--------|----------------------------|-------------|
| [0]*   | Relay 1                    |             |
| [1]    | Relay 2                    |             |
| [2]    | Terminal 27 digital output |             |
| [3]    | Terminal 29 digital output |             |

## Parameter 33-87 Terminal State at Alarm

Table 1233: Parameter 33-87 Terminal State at Alarm

| 33-87 Terminal State at Alarm |                        |                               |
|-------------------------------|------------------------|-------------------------------|
| Default value: [0] Do nothing | Parameter type: Option | Setup: 2 setups               |
| Conversion index: -           | Data type: Uint8       | Change during operation: True |

| Option | Name       | Description |
|--------|------------|-------------|
| [0]*   | Do nothing |             |
| [1]    | High       |             |
| [2]    | Low        |             |

## Parameter 33-88 Status Word at Alarm

Table 1234: Parameter 33-88 Status Word at Alarm

| 33-88 Status Word at Alarm |                                  |                               |
|----------------------------|----------------------------------|-------------------------------|
| Default value: 0           | Parameter type: Range, 0 - 65535 | Setup: 2 setups               |
| Conversion index: 0        | Data type: Uint16                | Change during operation: True |

## 5.26.6 33-9\* MCO Port Settings

## Parameter 33-90 X62 MCO CAN node ID

Table 1235: Parameter 33-90 X62 MCO CAN node ID

| 33-90 X62 MCO CAN node ID |                                |                               |
|---------------------------|--------------------------------|-------------------------------|
| Default value: 127        | Parameter type: Range, 0 - 127 | Setup: 2 setups               |
| Conversion index: 0       | Data type: Uint8               | Change during operation: True |

## Parameter 33-91 X62 MCO CAN Baud Rate

Table 1236: Parameter 33-91 X62 MCO CAN Baud Rate

| 33-91 X62 MCO CAN Baud Rate  |                        |                               |
|------------------------------|------------------------|-------------------------------|
| Default value: [20] 125 Kbps | Parameter type: Option | Setup: 2 setups               |
| Conversion index: -          | Data type: Uint8       | Change during operation: True |

| Option | Name      | Description |
|--------|-----------|-------------|
| [16]   | 10 Kbps   |             |
| [17]   | 20 Kbps   |             |
| [18]   | 50 Kbps   |             |
| [19]   | 100 Kbps  |             |
| [20]*  | 125 Kbps  |             |
| [21]   | 250 Kbps  |             |
| [22]   | 500 Kbps  |             |
| [24]   | 1000 Kbps |             |

## Parameter 33-94 X60 MCO RS485 Serial Termination

Table 1237: Parameter 33-94 X60 MCO RS485 Serial Termination

| 33-94 X60 MCO RS485 Serial Termination |                        |                               |
|--|------------------------|-------------------------------|
| Default value: [0] Off                 | Parameter type: Option | Setup: 2 setups               |
| Conversion index: -                    | Data type: Uint8       | Change during operation: True |

| Option | Name | Description |
|--------|------|-------------|
| [0]*   | Off  |             |
| [1]    | On   |             |

## Parameter 33-95 X60 MCO RS485 Serial Baud Rate

Table 1238: Parameter 33-95 X60 MCO RS485 Serial Baud Rate

| 33-95 X60 MCO RS485 Serial Baud Rate |                        |                               |
|--------------------------------------|------------------------|-------------------------------|
| Default value: [2] 9600 Baud         | Parameter type: Option | Setup: 2 setups               |
| Conversion index: -                  | Data type: Uint8       | Change during operation: True |

| Option | Name        | Description |
|--------|-------------|-------------|
| [0]    | 2400 Baud   |             |
| [1]    | 4800 Baud   |             |
| [2]*   | 9600 Baud   |             |
| [3]    | 19200 Baud  |             |
| [4]    | 38400 Baud  |             |
| [5]    | 57600 Baud  |             |
| [6]    | 76800 Baud  |             |
| [7]    | 115200 Baud |             |

## 5.27 Parameter Group 34-\*\* MCO Data Readouts

Parameters in this group are available when VLT® Motion Control Option MCO 305 is installed in the drive. For information about the option, refer to VLT® Motion Control Option MCO 302 Operating Instructions.

## 5.27.1 34-0\* PCD Write Par.

## Parameter 34-01 PCD 1 Write to MCO

Table 1239: Parameter 34-01 PCD 1 Write to MCO

| 34-01 PCD 1 Write to MCO |                                  |                               |
|--------------------------|----------------------------------|-------------------------------|
| Default value: 0         | Parameter type: Range, 0 - 65535 | Setup: All setups             |
| Conversion index: 0      | Data type: Uint16                | Change during operation: True |

Shows the value received in PCD1 of the fieldbus telegram.

## Parameter 34-02 PCD 2 Write to MCO

Table 1240: Parameter 34-02 PCD 2 Write to MCO

| 34-02 PCD 2 Write to MCO |                                  |                               |
|--------------------------|----------------------------------|-------------------------------|
| Default value: 0         | Parameter type: Range, 0 - 65535 | Setup: All setups             |
| Conversion index: 0      | Data type: Uint16                | Change during operation: True |

Shows the value received in PCD2 of the fieldbus telegram.

## Parameter 34-03 PCD 3 Write to MCO

Table 1241: Parameter 34-03 PCD 3 Write to MCO

| 34-03 PCD 3 Write to MCO |                                  |                               |
|--------------------------|----------------------------------|-------------------------------|
| Default value: 0         | Parameter type: Range, 0 - 65535 | Setup: All setups             |
| Conversion index: 0      | Data type: Uint16                | Change during operation: True |



Shows the value received in PCD3 of the fieldbus telegram.

Parameter 34-04 PCD 4 Write to MCO

Table 1242: Parameter 34-04 PCD 4 Write to MCO

| 34-04 PCD 4 Write to MCO |                                  |                               |
|--------------------------|----------------------------------|-------------------------------|
| Default value: 0         | Parameter type: Range, 0 - 65535 | Setup: All setups             |
| Conversion index: 0      | Data type: Uint16                | Change during operation: True |

Shows the value received in PCD4 of the fieldbus telegram.

Parameter 34-05 PCD 5 Write to MCO

Table 1243: Parameter 34-05 PCD 5 Write to MCO

| 34-05 PCD 5 Write to MCO |                                  |                               |
|--------------------------|----------------------------------|-------------------------------|
| Default value: 0         | Parameter type: Range, 0 - 65535 | Setup: All setups             |
| Conversion index: 0      | Data type: Uint16                | Change during operation: True |

Shows the value received in PCD5 of the fieldbus telegram.

Parameter 34-06 PCD 6 Write to MCO

Table 1244: Parameter 34-06 PCD 6 Write to MCO

| 34-06 PCD 6 Write to MCO |                                  |                               |
|--------------------------|----------------------------------|-------------------------------|
| Default value: 0         | Parameter type: Range, 0 - 65535 | Setup: All setups             |
| Conversion index: 0      | Data type: Uint16                | Change during operation: True |

Shows the value received in PCD6 of the fieldbus telegram.

Parameter 34-07 PCD 7 Write to MCO

Table 1245: Parameter 34-07 PCD 7 Write to MCO

| 34-07 PCD 7 Write to MCO |                                  |                               |
|--------------------------|----------------------------------|-------------------------------|
| Default value: 0         | Parameter type: Range, 0 - 65535 | Setup: All setups             |
| Conversion index: 0      | Data type: Uint16                | Change during operation: True |

Shows the value received in PCD7 of the fieldbus telegram.

Parameter 34-08 PCD 8 Write to MCO

Table 1246: Parameter 34-08 PCD 8 Write to MCO

| 34-08 PCD 8 Write to MCO |                                  |                               |
|--------------------------|----------------------------------|-------------------------------|
| Default value: 0         | Parameter type: Range, 0 - 65535 | Setup: All setups             |
| Conversion index: 0      | Data type: Uint16                | Change during operation: True |

Shows the value received in PCD8 of the fieldbus telegram.

Parameter 34-09 PCD 9 Write to MCO

Table 1247: Parameter 34-09 PCD 9 Write to MCO

| 34-09 PCD 9 Write to MCO |                                  |                               |
|--------------------------|----------------------------------|-------------------------------|
| Default value: 0         | Parameter type: Range, 0 - 65535 | Setup: All setups             |
| Conversion index: 0      | Data type: Uint16                | Change during operation: True |

Shows the value received in PCD9 of the fieldbus telegram.

## Parameter 34-10 PCD 10 Write to MCO

Table 1248: Parameter 34-10 PCD 10 Write to MCO

| 34-10 PCD 10 Write to MCO |                                  |                               |
|---------------------------|----------------------------------|-------------------------------|
| Default value: 0          | Parameter type: Range, 0 - 65535 | Setup: All setups             |
| Conversion index: 0       | Data type: Uint16                | Change during operation: True |

Shows the value received in PCD10 of the fieldbus telegram.

## 5.27.2 34-2\* PCD Read Par.

## Parameter 34-21 PCD 1 Read from MCO

Table 1249: Parameter 34-21 PCD 1 Read from MCO

| 34-21 PCD 1 Read from MCO |                                  |                               |
|---------------------------|----------------------------------|-------------------------------|
| Default value: 0          | Parameter type: Range, 0 - 65535 | Setup: All setups             |
| Conversion index: 0       | Data type: Uint16                | Change during operation: True |

Shows the value sent in PCD1 of the fieldbus telegram.

## Parameter 34-22 PCD 2 Read from MCO

Table 1250: Parameter 34-22 PCD 2 Read from MCO

| 34-22 PCD 2 Read from MCO |                                  |                               |
|---------------------------|----------------------------------|-------------------------------|
| Default value: 0          | Parameter type: Range, 0 - 65535 | Setup: All setups             |
| Conversion index: 0       | Data type: Uint16                | Change during operation: True |

Shows the value sent in PCD2 of the fieldbus telegram.

## Parameter 34-23 PCD 3 Read from MCO

Table 1251: Parameter 34-23 PCD 3 Read from MCO

| 34-23 PCD 3 Read from MCO |                                  |                               |
|---------------------------|----------------------------------|-------------------------------|
| Default value: 0          | Parameter type: Range, 0 - 65535 | Setup: All setups             |
| Conversion index: 0       | Data type: Uint16                | Change during operation: True |

Shows the value sent in PCD3 of the fieldbus telegram.

## Parameter 34-24 PCD 4 Read from MCO

Table 1252: Parameter 34-24 PCD 4 Read from MCO

| 34-24 PCD 4 Read from MCO |                                  |                               |
|---------------------------|----------------------------------|-------------------------------|
| Default value: 0          | Parameter type: Range, 0 - 65535 | Setup: All setups             |
| Conversion index: 0       | Data type: Uint16                | Change during operation: True |

Shows the value sent in PCD4 of the fieldbus telegram.

## Parameter 34-25 PCD 5 Read from MCO

Table 1253: Parameter 34-25 PCD 5 Read from MCO

| 34-25 PCD 5 Read from MCO |                                  |                               |
|---------------------------|----------------------------------|-------------------------------|
| Default value: 0          | Parameter type: Range, 0 - 65535 | Setup: All setups             |
| Conversion index: 0       | Data type: Uint16                | Change during operation: True |

Shows the value sent in PCD5 of the fieldbus telegram.  
Parameter 34-26 PCD 6 Read from MCO

Table 1254: Parameter 34-26 PCD 6 Read from MCO

| 34-26 PCD 6 Read from MCO |                                  |                               |
|---------------------------|----------------------------------|-------------------------------|
| Default value: 0          | Parameter type: Range, 0 - 65535 | Setup: All setups             |
| Conversion index: 0       | Data type: Uint16                | Change during operation: True |

Shows the value sent in PCD6 of the fieldbus telegram.  
Parameter 34-27 PCD 7 Read from MCO

Table 1255: Parameter 34-27 PCD 7 Read from MCO

| 34-27 PCD 7 Read from MCO |                                  |                               |
|---------------------------|----------------------------------|-------------------------------|
| Default value: 0          | Parameter type: Range, 0 - 65535 | Setup: All setups             |
| Conversion index: 0       | Data type: Uint16                | Change during operation: True |

Shows the value sent in PCD7 of the fieldbus telegram.  
Parameter 34-28 PCD 8 Read from MCO

Table 1256: Parameter 34-28 PCD 8 Read from MCO

| 34-28 PCD 8 Read from MCO |                                  |                               |
|---------------------------|----------------------------------|-------------------------------|
| Default value: 0          | Parameter type: Range, 0 - 65535 | Setup: All setups             |
| Conversion index: 0       | Data type: Uint16                | Change during operation: True |

Shows the value sent in PCD8 of the fieldbus telegram.  
Parameter 34-29 PCD 9 Read from MCO

Table 1257: Parameter 34-29 PCD 9 Read from MCO

| 34-29 PCD 9 Read from MCO |                                  |                               |
|---------------------------|----------------------------------|-------------------------------|
| Default value: 0          | Parameter type: Range, 0 - 65535 | Setup: All setups             |
| Conversion index: 0       | Data type: Uint16                | Change during operation: True |

Shows the value sent in PCD9 of the fieldbus telegram.  
Parameter 34-30 PCD 10 Read from MCO

Table 1258: Parameter 34-30 PCD 10 Read from MCO

| 34-30 PCD 10 Read from MCO |                                  |                               |
|----------------------------|----------------------------------|-------------------------------|
| Default value: 0           | Parameter type: Range, 0 - 65535 | Setup: All setups             |
| Conversion index: 0        | Data type: Uint16                | Change during operation: True |

Shows the value sent in PCD10 of the fieldbus telegram.

### 5.27.3 34-4\* Inputs & Outputs

Parameter 34-40 Digital Inputs

Table 1259: Parameter 34-40 Digital Inputs

| 34-40 Digital Inputs |                                 |                               |
|----------------------|---------------------------------|-------------------------------|
| Default value: 0     | Parameter type: Range, 0 - 4095 | Setup: All setups             |
| Conversion index: 0  | Data type: Uint16               | Change during operation: True |

## Parameter 34-41 Digital Outputs

Table 1260: Parameter 34-41 Digital Outputs

| 34-41 Digital Outputs |                                |                               |
|-----------------------|--------------------------------|-------------------------------|
| Default value: 0      | Parameter type: Range, 0 - 255 | Setup: All setups             |
| Conversion index: 0   | Data type: Uint16              | Change during operation: True |

## 5.27.4 34-5\* Process Data

## Parameter 34-50 Actual Position

Table 1261: Parameter 34-50 Actual Position

| 34-50 Actual Position |   |                               |
|-----------------------|---|-------------------------------|
| Default value: 0      | Parameter type: Range, -1073741824 - 1073741823 | Setup: All setups             |
| Conversion index: 0   | Data type: Int32                                | Change during operation: True |

The actual position in user unit.

## Parameter 34-51 Commanded Position

Table 1262: Parameter 34-51 Commanded Position

| 34-51 Commanded Position |   |                               |
|--------------------------|---|-------------------------------|
| Default value: 0         | Parameter type: Range, -1073741824 - 1073741823 | Setup: All setups             |
| Conversion index: 0      | Data type: Int32                                | Change during operation: True |

## Parameter 34-52 Actual Master Position

Table 1263: Parameter 34-52 Actual Master Position

| 34-52 Actual Master Position |   |                               |
|------------------------------|---|-------------------------------|
| Default value: 0             | Parameter type: Range, -1073741824 - 1073741823 | Setup: All setups             |
| Conversion index: 0          | Data type: Int32                                | Change during operation: True |

## Parameter 34-53 Slave Index Position

Table 1264: Parameter 34-53 Slave Index Position

| 34-53 Slave Index Position |   |                               |
|----------------------------|---|-------------------------------|
| Default value: 0           | Parameter type: Range, -1073741824 - 1073741823 | Setup: All setups             |
| Conversion index: 0        | Data type: Int32                                | Change during operation: True |

## Parameter 34-54 Master Index Position

Table 1265: Parameter 34-54 Master Index Position

| 34-54 Master Index Position |   |                               |
|-----------------------------|---|-------------------------------|
| Default value: 0            | Parameter type: Range, -1073741824 - 1073741823 | Setup: All setups             |
| Conversion index: 0         | Data type: Int32                                | Change during operation: True |

## Parameter 34-55 Curve Position

Table 1266: Parameter 34-55 Curve Position

| 34-55 Curve Position |   |                               |
|----------------------|---|-------------------------------|
| Default value: 0     | Parameter type: Range, -1073741824 - 1073741823 | Setup: All setups             |
| Conversion index: 0  | Data type: Int32                                | Change during operation: True |

## Parameter 34-56 Track Error

Table 1267: Parameter 34-56 Track Error

| 34-56 Track Error   |   |                               |
|---------------------|---|-------------------------------|
| Default value: 0    | Parameter type: Range, -1073741828 - 1073741827 | Setup: All setups             |
| Conversion index: 0 | Data type: Int32                                | Change during operation: True |

Readout of the error between the calculated command position and the actual position in user unit.

## Parameter 34-57 Synchronizing Error

Table 1268: Parameter 34-57 Synchronizing Error

| 34-57 Synchronizing Error |   |                               |
|---------------------------|---|-------------------------------|
| Default value: 0          | Parameter type: Range, -1073741828 - 1073741827 | Setup: All setups             |
| Conversion index: 0       | Data type: Int32                                | Change during operation: True |

## Parameter 34-58 Actual Velocity

Table 1269: Parameter 34-58 Actual Velocity

| 34-58 Actual Velocity |   |                               |
|-----------------------|---|-------------------------------|
| Default value: 0      | Parameter type: Range, -1073741828 - 1073741827 | Setup: All setups             |
| Conversion index: 0   | Data type: Int32                                | Change during operation: True |

## Parameter 34-59 Actual Master Velocity

Table 1270: Parameter 34-59 Actual Master Velocity

| 34-59 Actual Master Velocity |   |                               |
|------------------------------|---|-------------------------------|
| Default value: 0             | Parameter type: Range, -1073741828 - 1073741827 | Setup: All setups             |
| Conversion index: 0          | Data type: Int32                                | Change during operation: True |

## Parameter 34-60 Synchronizing Status

Table 1271: Parameter 34-60 Synchronizing Status

| 34-60 Synchronizing Status |   |                               |
|----------------------------|---|-------------------------------|
| Default value: 0           | Parameter type: Range, -1073741828 - 1073741827 | Setup: All setups             |
| Conversion index: 0        | Data type: Int32                                | Change during operation: True |

## Parameter 34-61 Axis Status

Table 1272: Parameter 34-61 Axis Status

| 34-61 Axis Status   |   |                               |
|---------------------|---|-------------------------------|
| Default value: 0    | Parameter type: Range, -1073741828 - 1073741827 | Setup: All setups             |
| Conversion index: 0 | Data type: Int32                                | Change during operation: True |

## Parameter 34-62 Program Status

Table 1273: Parameter 34-62 Program Status

| 34-62 Program Status |   |                               |
|----------------------|---|-------------------------------|
| Default value: 0     | Parameter type: Range, -1073741828 - 1073741827 | Setup: All setups             |
| Conversion index: 0  | Data type: Int32                                | Change during operation: True |

## Parameter 34-64 MCO 302 Status

Table 1274: Parameter 34-64 MCO 302 Status

| 34-64 MCO 302 Status |                                  |                               |
|----------------------|----------------------------------|-------------------------------|
| Default value: 0     | Parameter type: Range, 0 - 16384 | Setup: All setups             |
| Conversion index: 0  | Data type: Uint16                | Change during operation: True |

## Parameter 34-65 MCO 302 Control

Table 1275: Parameter 34-65 MCO 302 Control

| 34-65 MCO 302 Control |                                  |                               |
|-----------------------|----------------------------------|-------------------------------|
| Default value: 0      | Parameter type: Range, 0 - 16384 | Setup: All setups             |
| Conversion index: 0   | Data type: Uint16                | Change during operation: True |

## Parameter 34-66 SPI Error Counter

Table 1276: Parameter 34-66 SPI Error Counter

| 34-66 SPI Error Counter |                                       |                                |
|-------------------------|---------------------------------------|--------------------------------|
| Default value: 0        | Parameter type: Range, 0 - 4294967295 | Setup: All setups              |
| Conversion index: 0     | Data type: Uint32                     | Change during operation: False |

## 5.27.5 34-7\* Diagnosis Readouts

## Parameter 34-70 MCO Alarm Word 1

Table 1277: Parameter 34-70 MCO Alarm Word 1

| 34-70 MCO Alarm Word 1 |                                       |                                |
|------------------------|---------------------------------------|--------------------------------|
| Default value: 0       | Parameter type: Range, 0 - 4294967295 | Setup: All setups              |
| Conversion index: 0    | Data type: Uint32                     | Change during operation: False |

## Parameter 34-71 MCO Alarm Word 2

Table 1278: Parameter 34-71 MCO Alarm Word 2

| 34-71 MCO Alarm Word 2 |                                       |                                |
|------------------------|---------------------------------------|--------------------------------|
| Default value: 0       | Parameter type: Range, 0 - 4294967295 | Setup: All setups              |
| Conversion index: 0    | Data type: Uint32                     | Change during operation: False |

## 5.28 Parameter Group 35-\*\* Sensor Input Option

Parameters for configuring the functionality of VLT® Sensor Input MCB 114.

## 5.28.1 35-0\* Temp. Input Mode

## Parameter 35-00 Term. X48/4 Temperature Unit

Table 1279: Parameter 35-00 Term. X48/4 Temperature Unit

| 35-00 Term. X48/4 Temperature Unit |                        |                               |
|------------------------------------|------------------------|-------------------------------|
| Default value: [60] °C             | Parameter type: Option | Setup: All setups             |
| Conversion index: -                | Data type: Uint8       | Change during operation: True |

Select the unit to be used with temperature input X48/4 settings and readouts.

| Option | Name | Description |
|--------|------|-------------|
| [60]*  | °C   |             |
| [160]  | °F   |             |

## Parameter 35-01 Term. X48/4 Input Type

Table 1280: Parameter 35-01 Term. X48/4 Input Type

| 35-01 Term. X48/4 Input Type     |                        |                               |
|----------------------------------|------------------------|-------------------------------|
| Default value: [0] Not connected | Parameter type: Option | Setup: All setups             |
| Conversion index: -              | Data type: Uint8       | Change during operation: True |

View the temperature sensor type detected at input X48/4.

| Option | Name          | Description |
|--------|---------------|-------------|
| [0]*   | Not connected |             |
| [1]    | PT100 2-wire  |             |
| [3]    | PT1000 2-wire |             |
| [5]    | PT100 3-wire  |             |
| [7]    | PT1000 3-wire |             |

## Parameter 35-02 Term. X48/7 Temperature Unit

Table 1281: Parameter 35-02 Term. X48/7 Temperature Unit

| 35-02 Term. X48/7 Temperature Unit |                        |                               |
|------------------------------------|------------------------|-------------------------------|
| Default value: [60] °C             | Parameter type: Option | Setup: All setups             |
| Conversion index: -                | Data type: Uint8       | Change during operation: True |

Select the unit to be used with temperature input X48/7 settings and readouts.

| Option | Name | Description |
|--------|------|-------------|
| [60]*  | °C   |             |
| [160]  | °F   |             |

## Parameter 35-03 Term. X48/7 Input Type

Table 1282: Parameter 35-03 Term. X48/7 Input Type

| 35-03 Term. X48/7 Input Type     |                        |                               |
|----------------------------------|------------------------|-------------------------------|
| Default value: [0] Not connected | Parameter type: Option | Setup: All setups             |
| Conversion index: -              | Data type: Uint8       | Change during operation: True |

View the temperature sensor type detected at input X48/7.

| Option | Name          | Description |
|--------|---------------|-------------|
| [0]*   | Not connected |             |
| [1]    | PT100 2-wire  |             |

| Option | Name          | Description |
|--------|---------------|-------------|
| [3]    | PT1000 2-wire |             |
| [5]    | PT100 3-wire  |             |
| [7]    | PT1000 3-wire |             |

Parameter 35-04 Term. X48/10 Temperature Unit

Table 1283: Parameter 35-04 Term. X48/10 Temperature Unit

| 35-04 Term. X48/10 Temperature Unit |                        |                               |
|-------------------------------------|------------------------|-------------------------------|
| Default value: [60] °C              | Parameter type: Option | Setup: All setups             |
| Conversion index: -                 | Data type: Uint8       | Change during operation: True |

Select the unit to be used with temperature input X48/10 settings and readouts.

| Option | Name | Description |
|--------|------|-------------|
| [60]*  | °C   |             |
| [160]  | °F   |             |

Parameter 35-05 Term. X48/10 Input Type

Table 1284: Parameter 35-05 Term. X48/10 Input Type

| 35-05 Term. X48/10 Input Type    |                        |                               |
|----------------------------------|------------------------|-------------------------------|
| Default value: [0] Not connected | Parameter type: Option | Setup: All setups             |
| Conversion index: -              | Data type: Uint8       | Change during operation: True |

View the temperature sensor type detected at input X48/10.

| Option | Name          | Description |
|--------|---------------|-------------|
| [0]*   | Not connected |             |
| [1]    | PT100 2-wire  |             |
| [3]    | PT1000 2-wire |             |
| [5]    | PT100 3-wire  |             |
| [7]    | PT1000 3-wire |             |

Parameter 35-06 Temperature Sensor Alarm Function

Table 1285: Parameter 35-06 Temperature Sensor Alarm Function

| 35-06 Temperature Sensor Alarm Function |                        |                               |
|---|------------------------|-------------------------------|
| Default value: [5] Stop and trip        | Parameter type: Option | Setup: All setups             |
| Conversion index: -                     | Data type: Uint8       | Change during operation: True |

Set the alarm function.



| Option | Name                 | Description |
|--------|----------------------|-------------|
| [0]    | Off                  |             |
| [2]    | Stop                 |             |
| [5]*   | Stop and trip        |             |
| [27]   | Forced stop and trip |             |

### 5.28.2 35-1\* Temp. Input X48/4

#### Parameter 35-14 Term. X48/4 Filter Time Constant

Table 1286: Parameter 35-14 Term. X48/4 Filter Time Constant

| 35-14 Term. X48/4 Filter Time Constant |                                     |                               |
|--|-------------------------------------|-------------------------------|
| Default value: 0.001 s                 | Parameter type: Range, 0.001 - 10 s | Setup: All setups             |
| Conversion index: 0                    | Data type: Uint16                   | Change during operation: True |

Enter the filter time constant. This is a first-order digital low-pass filter time constant for suppressing electrical noise in terminal X48/4. A high time constant value improves dampening but also increases the time delay through the filter.

#### Parameter 35-15 Term. X48/4 Temp. Monitor

Table 1287: Parameter 35-15 Term. X48/4 Temp. Monitor

| 35-15 Term. X48/4 Temp. Monitor |                        |                               |
|---------------------------------|------------------------|-------------------------------|
| Default value: [0] Disabled     | Parameter type: Option | Setup: All setups             |
| Conversion index: -             | Data type: Uint8       | Change during operation: True |

This parameter facilitates the possibility of enabling or disabling the temperature monitor for terminal X48/4. Set the temperature limits in *parameter 35-16 Term. X48/4 Low Temp. Limit* and *parameter 35-17 Term. X48/4 High Temp. Limit*.

| Option | Name     | Description |
|--------|----------|-------------|
| [0]*   | Disabled |             |
| [1]    | Enabled  |             |

#### Parameter 35-16 Term. X48/4 Low Temp. Limit

Table 1288: Parameter 35-16 Term. X48/4 Low Temp. Limit

| 35-16 Term. X48/4 Low Temp. Limit |                            |                               |
|-----------------------------------|----------------------------|-------------------------------|
| Default value: Size related       | Parameter type: Range, N/A | Setup: All setups             |
| Conversion index: 0               | Data type: Int16           | Change during operation: True |

Enter the minimum temperature reading that is expected for normal operation of the temperature sensor at terminal X48/4.

#### Parameter 35-17 Term. X48/4 High Temp. Limit

Table 1289: Parameter 35-17 Term. X48/4 High Temp. Limit

| 35-17 Term. X48/4 High Temp. Limit |                            |                               |
|------------------------------------|----------------------------|-------------------------------|
| Default value: Size related        | Parameter type: Range, N/A | Setup: All setups             |
| Conversion index: 0                | Data type: Int16           | Change during operation: True |

Enter the maximum temperature reading that is expected for normal operation of the temperature sensor at terminal X48/4.

### 5.28.3 35-2\* Temp. Input X48/7

Table 1290: Parameter 35-24 Term. X48/7 Filter Time Constant

| 35-24 Term. X48/7 Filter Time Constant |                                     |                               |
|--|-------------------------------------|-------------------------------|
| Default value: 0.001 s                 | Parameter type: Range, 0.001 - 10 s | Setup: All setups             |
| Conversion index: 0                    | Data type: Uint16                   | Change during operation: True |

Enter the filter time constant. This is a first-order digital low-pass filter time constant for suppressing electrical noise in terminal X48/7. A high time constant value improves dampening but also increases the time delay through the filter.

#### Parameter 35-25 Term. X48/7 Temp. Monitor

Table 1291: Parameter 35-25 Term. X48/7 Temp. Monitor

| 35-25 Term. X48/7 Temp. Monitor |                        |                               |
|---------------------------------|------------------------|-------------------------------|
| Default value: [0] Disabled     | Parameter type: Option | Setup: All setups             |
| Conversion index: -             | Data type: Uint8       | Change during operation: True |

This parameter facilitates the possibility of enabling or disabling the temperature monitor for terminal X48/4. Set the temperature limits in *parameter 35-26 Term. X48/7 Low Temp. Limit* and *parameter 35-27 Term. X48/7 High Temp. Limit*.

| Option | Name     | Description |
|--------|----------|-------------|
| [0]*   | Disabled |             |
| [1]    | Enabled  |             |

#### Parameter 35-26 Term. X48/7 Low Temp. Limit

Table 1292: Parameter 35-26 Term. X48/7 Low Temp. Limit

| 35-26 Term. X48/7 Low Temp. Limit |                            |                               |
|-----------------------------------|----------------------------|-------------------------------|
| Default value: Size related       | Parameter type: Range, N/A | Setup: All setups             |
| Conversion index: 0               | Data type: Int16           | Change during operation: True |

Enter the minimum temperature reading that is expected for normal operation of the temperature sensor at terminal X48/7.

#### Parameter 35-27 Term. X48/7 High Temp. Limit

Table 1293: Parameter 35-27 Term. X48/7 High Temp. Limit

| 35-27 Term. X48/7 High Temp. Limit |                            |                               |
|------------------------------------|----------------------------|-------------------------------|
| Default value: Size related        | Parameter type: Range, N/A | Setup: All setups             |
| Conversion index: 0                | Data type: Int16           | Change during operation: True |

Enter the maximum temperature reading that is expected for normal operation of the temperature sensor at terminal X48/7.

### 5.28.4 35-3\* Temp. Input X48/10

#### Parameter 35-34 Term. X48/10 Filter Time Constant

Table 1294: Parameter 35-34 Term. X48/10 Filter Time Constant

| 35-34 Term. X48/10 Filter Time Constant |                                     |                               |
|---|-------------------------------------|-------------------------------|
| Default value: 0.001 s                  | Parameter type: Range, 0.001 - 10 s | Setup: All setups             |
| Conversion index: 0                     | Data type: Uint16                   | Change during operation: True |

Enter the filter time constant. This is a first-order digital low-pass filter time constant for suppressing electrical noise in terminal X48/10. A high time constant value improves dampening but also increases the time delay through the filter.

Parameter 35-35 Term. X48/10 Temp. Monitor

Table 1295: Parameter 35-35 Term. X48/10 Temp. Monitor

| 35-35 Term. X48/10 Temp. Monitor |                        |                               |
|----------------------------------|------------------------|-------------------------------|
| Default value: [0] Disabled      | Parameter type: Option | Setup: All setups             |
| Conversion index: -              | Data type: Uint8       | Change during operation: True |

This parameter facilitates the possibility of enabling or disabling the temperature monitor for terminal X48/4. Set the temperature limits in *parameter 35-36 Term. X48/10 Low Temp. Limit* and *parameter 35-37 Term. X48/10 High Temp. Limit*.

| Option | Name     | Description |
|--------|----------|-------------|
| [0]*   | Disabled |             |
| [1]    | Enabled  |             |

Parameter 35-36 Term. X48/10 Low Temp. Limit

Table 1296: Parameter 35-36 Term. X48/10 Low Temp. Limit

| 35-36 Term. X48/10 Low Temp. Limit |                            |                               |
|------------------------------------|----------------------------|-------------------------------|
| Default value: Size related        | Parameter type: Range, N/A | Setup: All setups             |
| Conversion index: 0                | Data type: Int16           | Change during operation: True |

Enter the minimum temperature reading that is expected for normal operation of the temperature sensor at terminal X48/10.

Parameter 35-37 Term. X48/10 High Temp. Limit

Table 1297: Parameter 35-37 Term. X48/10 High Temp. Limit

| 35-37 Term. X48/10 High Temp. Limit |                            |                               |
|-------------------------------------|----------------------------|-------------------------------|
| Default value: Size related         | Parameter type: Range, N/A | Setup: All setups             |
| Conversion index: 0                 | Data type: Int16           | Change during operation: True |

Enter the maximum temperature reading that is expected for normal operation of the temperature sensor at terminal X48/10.

### 5.28.5 35-4\* Analog Input X48/2

Parameter 35-42 Term. X48/2 Low Current

Table 1298: Parameter 35-42 Term. X48/2 Low Current

| 35-42 Term. X48/2 Low Current |                                  |                               |
|-------------------------------|----------------------------------|-------------------------------|
| Default value: 4 mA           | Parameter type: Range, 0 - 20 mA | Setup: All setups             |
| Conversion index: -3          | Data type: Int16                 | Change during operation: True |

Enter the current (mA) that corresponds to the low reference value set in *parameter 35-44 Term. X48/2 Low Ref./Feedb. Value*. The value must be more than 2 mA to activate the live zero timeout function in *parameter 6-01 Live Zero Timeout Function*.

Parameter 35-43 Term. X48/2 High Current

Table 1299: Parameter 35-43 Term. X48/2 High Current

| 35-43 Term. X48/2 High Current |                                  |                               |
|--------------------------------|----------------------------------|-------------------------------|
| Default value: 20 mA           | Parameter type: Range, 0 - 20 mA | Setup: All setups             |
| Conversion index: -3           | Data type: Int16                 | Change during operation: True |

Enter the current (mA) that corresponds to the high reference value set in *parameter 35-45 Term. X48/2 High Ref./Feedb. Value*.  
Parameter 35-44 Term. 48/2 Low Ref./Feedb. Value

Table 1300: Parameter 35-44 Term. 48/2 Low Ref./Feedb. Value

| 35-44 Term. 48/2 Low Ref./Feedb. Value |   |                               |
|--|---|-------------------------------|
| Default value: 0 ReferenceFeedbackUnit | Parameter type: Range, -999999.999 - 999999.999 ReferenceFeedbackUnit | Setup: All setups             |
| Conversion index: 0                    | Data type: Int32  | Change during operation: True |

Enter the reference or feedback value (in RPM, Hz, bar, and so on) that corresponds to the voltage or current set in *parameter 35-42 Term. X48/2 Low Current*.

Parameter 35-45 Term. 48/2 High Ref./Feedb. Value

Table 1301: Parameter 35-45 Term. 48/2 High Ref./Feedb. Value

| 35-45 Term. 48/2 High Ref./Feedb. Value  |   |                               |
|--|---|-------------------------------|
| Default value: 100 ReferenceFeedbackUnit | Parameter type: Range, -999999.999 - 999999.999 ReferenceFeedbackUnit | Setup: All setups             |
| Conversion index: 0                      | Data type: Int32  | Change during operation: True |

Enter the reference or feedback value (in RPM, Hz, bar, and so on) that corresponds to the voltage or current set in *parameter 35-43 Term. X48/2 High Current*.

Parameter 35-46 Term. X48/2 Filter Time Constant

Table 1302: Parameter 35-46 Term. X48/2 Filter Time Constant

| 35-46 Term. X48/2 Filter Time Constant |                                     |                               |
|--|-------------------------------------|-------------------------------|
| Default value: 0.001 s                 | Parameter type: Range, 0.001 - 10 s | Setup: All setups             |
| Conversion index: 0                    | Data type: Uint16                   | Change during operation: True |

Enter the filter time constant. This is a first-order digital low-pass filter time constant for suppressing electrical noise in terminal X48/2. A high time constant value improves dampening but also increases the time delay through the filter.

## 5.29 Parameter Group 36-\*\* Programmable I/O Option

Parameters for configuring VLT® Programmable I/O MCB 115.

Parameters in this group are only active if VLT® Programmable I/O MCB 115 is installed.

### 5.29.1 36-0\* I/O Mode

#### N O T I C E

The following parameters are only available in FC 302:

- *Parameter 36-00 Terminal X49/1 Mode*
- *Parameter 36-01 Terminal X49/3 Mode*
- *Parameter 36-02 Terminal X49/5 Mode*

Parameter 36-00 Term. X49/1 Mode

Table 1303: Parameter 36-00 Term. X49/1 Mode

| 36-00 Term. X49/1 Mode     |                        |                               |
|----------------------------|------------------------|-------------------------------|
| Default value: [1] Voltage | Parameter type: Option | Setup: All setups             |
| Conversion index: -        | Data type: Uint8       | Change during operation: True |

Select the output mode of analog terminal X49/1.

| Option | Name         | Description |
|--------|--------------|-------------|
| [0]    | Current      |             |
| [1]*   | Voltage      |             |
| [2]    | PT1000 [°C]  |             |
| [3]    | PT1000 [°F]  |             |
| [4]    | Ni 1000 [°C] |             |
| [5]    | Ni 1000 [°F] |             |

Parameter 36-01 Term. X49/3 Mode

Table 1304: Parameter 36-01 Term. X49/3 Mode

| 36-01 Term. X49/3 Mode     |                        |                               |
|----------------------------|------------------------|-------------------------------|
| Default value: [1] Voltage | Parameter type: Option | Setup: All setups             |
| Conversion index: -        | Data type: Uint8       | Change during operation: True |

Select the output mode of analog terminal X49/3.

| Option | Name         | Description |
|--------|--------------|-------------|
| [0]    | Current      |             |
| [1]*   | Voltage      |             |
| [2]    | PT1000 [°C]  |             |
| [3]    | PT1000 [°F]  |             |
| [4]    | Ni 1000 [°C] |             |
| [5]    | Ni 1000 [°F] |             |

Parameter 36-02 Term. X49/5 Mode

Table 1305: Parameter 36-02 Term. X49/5 Mode

| 36-02 Term. X49/5 Mode     |                        |                               |
|----------------------------|------------------------|-------------------------------|
| Default value: [1] Voltage | Parameter type: Option | Setup: All setups             |
| Conversion index: -        | Data type: Uint8       | Change during operation: True |

Select the output mode of analog terminal X49/5.

| Option | Name         | Description |
|--------|--------------|-------------|
| [0]    | Current      |             |
| [1]*   | Voltage      |             |
| [2]    | PT1000 [°C]  |             |
| [3]    | PT1000 [°F]  |             |
| [4]    | Ni 1000 [°C] |             |
| [5]    | Ni 1000 [°F] |             |

Parameter 36-03 Term. X49/7 Mode

Table 1306: Parameter 36-03 Term. X49/7 Mode

| 36-03 Term. X49/7 Mode           |                        |                               |
|----------------------------------|------------------------|-------------------------------|
| Default value: [0] Voltage 0–10V | Parameter type: Option | Setup: All setups             |
| Conversion index: -              | Data type: Uint8       | Change during operation: True |

Select the output mode of analog terminal X49/7.

| Option | Name           | Description   |
|--------|----------------|---|
| [0]*   | Voltage 0–10V  |   |
| [1]    | Voltage 2–10V  |   |
| [2]    | Current 0–20mA |   |
| [3]    | Current 4–20mA |   |
| [4]    | Digital        | <div style="text-align: center; background-color: #cccccc; padding: 5px;"><b>NOTICE</b></div> <p>This option is only available in FC 302.</p> |

Parameter 36-04 Term. X49/9 Mode

Table 1307: Parameter 36-04 Term. X49/9 Mode

| 36-04 Term. X49/9 Mode           |                        |                               |
|----------------------------------|------------------------|-------------------------------|
| Default value: [0] Voltage 0–10V | Parameter type: Option | Setup: All setups             |
| Conversion index: -              | Data type: Uint8       | Change during operation: True |

Select the output mode of analog terminal X49/9.

| Option | Name           | Description   |
|--------|----------------|---|
| [0]*   | Voltage 0–10V  |   |
| [1]    | Voltage 2–10V  |   |
| [2]    | Current 0–20mA |   |
| [3]    | Current 4–20mA |   |
| [4]    | Digital        | <div style="text-align: center; background-color: #cccccc; padding: 5px;"><b>NOTICE</b></div> <p>This option is only available in FC 302.</p> |

Parameter 36-05 Term. X49/11 Mode

Table 1308: Parameter 36-05 Term. X49/11 Mode

| 36-05 Term. X49/11 Mode          |                        |                               |
|----------------------------------|------------------------|-------------------------------|
| Default value: [0] Voltage 0–10V | Parameter type: Option | Setup: All setups             |
| Conversion index: -              | Data type: Uint8       | Change during operation: True |

Select the output mode of analog terminal X49/11.

| Option | Name           | Description  |
|--------|----------------|--|
| [0]*   | Voltage 0–10V  |  |
| [1]    | Voltage 2–10V  |  |
| [2]    | Current 0–20mA |  |
| [3]    | Current 4–20mA |  |
| [4]    | Digital        | <div style="text-align: center; background-color: #cccccc; padding: 5px;"><b>NOTICE</b></div> <div style="border: 1px solid black; padding: 5px;">This option is only available in FC 302.</div> |

### 5.29.2 36-1\* Analog Input X49/1

#### NOTICE

This parameter group is only available in FC 301.

Parameter 36-10 Terminal X49/1 Low Voltage

Table 1309: Parameter 36-10 Terminal X49/1 Low Voltage

| 36-10 Terminal X49/1 Low Voltage |                                 |                               |
|----------------------------------|---------------------------------|-------------------------------|
| Default value: 0.07 V            | Parameter type: Range, 0 - 10 V | Setup: All setups             |
| Conversion index: 0              | Data type: Int16                | Change during operation: True |

Parameter 36-11 Terminal X49/1 Low Current

Table 1310: Parameter 36-11 Terminal X49/1 Low Current

| 36-11 Terminal X49/1 Low Current |                                  |                               |
|----------------------------------|----------------------------------|-------------------------------|
| Default value: 4 mA              | Parameter type: Range, 0 - 20 mA | Setup: All setups             |
| Conversion index: -3             | Data type: Int16                 | Change during operation: True |

Parameter 36-12 Terminal X49/1 High Voltage

Table 1311: Parameter 36-12 Terminal X49/1 High Voltage

| 36-12 Terminal X49/1 High Voltage |                                 |                               |
|-----------------------------------|---------------------------------|-------------------------------|
| Default value: 10 V               | Parameter type: Range, 0 - 10 V | Setup: All setups             |
| Conversion index: 0               | Data type: Int16                | Change during operation: True |

Parameter 36-13 Terminal X49/1 High Current

Table 1312: Parameter 36-13 Terminal X49/1 High Current

| 36-13 Terminal X49/1 High Current |                                  |                               |
|-----------------------------------|----------------------------------|-------------------------------|
| Default value: 20 mA              | Parameter type: Range, 0 - 20 mA | Setup: All setups             |
| Conversion index: -3              | Data type: Int16                 | Change during operation: True |

## Parameter 36-14 Terminal X49/1 Low Ref./Feedb. Value

Table 1313: Parameter 36-14 Terminal X49/1 Low Ref./Feedb. Value

| 36-14 Terminal X49/1 Low Ref./Feedb. Value |  |                               |
|--|--|-------------------------------|
| Default value: 0 ReferenceFeedbackUnit     | Parameter type: Range, -999999.999 - 999999.999<br>ReferenceFeedbackUnit | Setup: All setups             |
| Conversion index: 0                        | Data type: Int32   | Change during operation: True |

## Parameter 36-15 Terminal X49/1 High Ref./Feedb. Value

Table 1314: Parameter 36-15 Terminal X49/1 High Ref./Feedb. Value

| 36-15 Terminal X49/1 High Ref./Feedb. Value |  |                               |
|---|--|-------------------------------|
| Default value: 100 ReferenceFeedbackUnit    | Parameter type: Range, -999999.999 - 999999.999<br>ReferenceFeedbackUnit | Setup: All setups             |
| Conversion index: 0                         | Data type: Int32   | Change during operation: True |

## Parameter 36-16 Term. X49/1 Filter Time Constant

Table 1315: Parameter 36-16 Term. X49/1 Filter Time Constant

| 36-16 Term. X49/1 Filter Time Constant |                                     |                               |
|--|-------------------------------------|-------------------------------|
| Default value: 0.001 s                 | Parameter type: Range, 0.001 - 10 s | Setup: All setups             |
| Conversion index: 0                    | Data type: Uint16                   | Change during operation: True |

Enter the filter time constant. This is a first-order digital low-pass filter time constant for suppressing electrical noise in terminal X49/1. A high time constant value improves dampening but also increases the time delay through the filter.

## 5.29.3 36-2\* Analog Input X49/3

### N O T I C E

This parameter group is only available in FC 302.

## Parameter 36-20 Terminal X49/3 Low Voltage

Table 1316: Parameter 36-20 Terminal X49/3 Low Voltage

| 36-20 Terminal X49/3 Low Voltage |                                 |                               |
|----------------------------------|---------------------------------|-------------------------------|
| Default value: 0.07 V            | Parameter type: Range, 0 - 10 V | Setup: All setups             |
| Conversion index: 0              | Data type: Int16                | Change during operation: True |

## Parameter 36-21 Terminal X49/3 Low Current

Table 1317: Parameter 36-21 Terminal X49/3 Low Current

| 36-21 Terminal X49/3 Low Current |                                  |                               |
|----------------------------------|----------------------------------|-------------------------------|
| Default value: 4 mA              | Parameter type: Range, 0 - 20 mA | Setup: All setups             |
| Conversion index: -3             | Data type: Int16                 | Change during operation: True |



## Parameter 36-22 Terminal X49/3 High Voltage

Table 1318: Parameter 36-22 Terminal X49/3 High Voltage

| 36-22 Terminal X49/3 High Voltage |                                 |                               |
|-----------------------------------|---------------------------------|-------------------------------|
| Default value: 10 V               | Parameter type: Range, 0 - 10 V | Setup: All setups             |
| Conversion index: 0               | Data type: Int16                | Change during operation: True |

## Parameter 36-23 Terminal X49/3 High Current

Table 1319: Parameter 36-23 Terminal X49/3 High Current

| 36-23 Terminal X49/3 High Current |                                  |                               |
|-----------------------------------|----------------------------------|-------------------------------|
| Default value: 20 mA              | Parameter type: Range, 0 - 20 mA | Setup: All setups             |
| Conversion index: -3              | Data type: Int16                 | Change during operation: True |

## Parameter 36-24 Terminal X49/3 Low Ref./Feedb. Value

Table 1320: Parameter 36-24 Terminal X49/3 Low Ref./Feedb. Value

| 36-24 Terminal X49/3 Low Ref./Feedb. Value |  |                               |
|--|--|-------------------------------|
| Default value: 0 ReferenceFeedbackUnit     | Parameter type: Range, -999999.999 - 999999.999<br>ReferenceFeedbackUnit | Setup: All setups             |
| Conversion index: 0                        | Data type: Int32   | Change during operation: True |

## Parameter 36-25 Terminal X49/3 High Ref./Feedb. Value

Table 1321: Parameter 36-25 Terminal X49/3 High Ref./Feedb. Value

| 36-25 Terminal X49/3 High Ref./Feedb. Value |  |                               |
|---|--|-------------------------------|
| Default value: 100 ReferenceFeedbackUnit    | Parameter type: Range, -999999.999 - 999999.999<br>ReferenceFeedbackUnit | Setup: All setups             |
| Conversion index: 0                         | Data type: Int32   | Change during operation: True |

## Parameter 36-26 Term. X49/3 Filter Time Constant

Table 1322: Parameter 36-26 Term. X49/3 Filter Time Constant

| 36-26 Term. X49/3 Filter Time Constant |                                     |                               |
|--|-------------------------------------|-------------------------------|
| Default value: 0.001 s                 | Parameter type: Range, 0.001 - 10 s | Setup: All setups             |
| Conversion index: 0                    | Data type: UInt16                   | Change during operation: True |

Enter the filter time constant. This is a first-order digital low-pass filter time constant for suppressing electrical noise in terminal X49/3. A high time constant value improves dampening but also increases the time delay through the filter.

## 5.29.4 36-3\* Analog Input X49/5

## N O T I C E

This parameter group is only available in FC 302.

## Parameter 36-30 Terminal X49/5 Low Voltage

Table 1323: Parameter 36-30 Terminal X49/5 Low Voltage

| 36-30 Terminal X49/5 Low Voltage |                                 |                               |
|----------------------------------|---------------------------------|-------------------------------|
| Default value: 0.07 V            | Parameter type: Range, 0 - 10 V | Setup: All setups             |
| Conversion index: 0              | Data type: Int16                | Change during operation: True |

## Parameter 36-31 Terminal X49/3 Low Current

Table 1324: Parameter 36-31 Terminal X49/3 Low Current

| 36-31 Terminal X49/3 Low Current |                                  |                               |
|----------------------------------|----------------------------------|-------------------------------|
| Default value: 4 mA              | Parameter type: Range, 0 - 20 mA | Setup: All setups             |
| Conversion index: -3             | Data type: Int16                 | Change during operation: True |

## Parameter 36-32 Terminal X49/5 High Voltage

Table 1325: Parameter 36-32 Terminal X49/5 High Voltage

| 36-32 Terminal X49/5 High Voltage |                                 |                               |
|-----------------------------------|---------------------------------|-------------------------------|
| Default value: 10 V               | Parameter type: Range, 0 - 10 V | Setup: All setups             |
| Conversion index: 0               | Data type: Int16                | Change during operation: True |

## Parameter 36-33 Terminal X49/5 High Current

Table 1326: Parameter 36-33 Terminal X49/5 High Current

| 36-33 Terminal X49/5 High Current |                                  |                               |
|-----------------------------------|----------------------------------|-------------------------------|
| Default value: 20 mA              | Parameter type: Range, 0 - 20 mA | Setup: All setups             |
| Conversion index: -3              | Data type: Int16                 | Change during operation: True |

## Parameter 36-34 Terminal X49/5 Low Ref./Feedb. Value

Table 1327: Parameter 36-34 Terminal X49/5 Low Ref./Feedb. Value

| 36-34 Terminal X49/5 Low Ref./Feedb. Value |   |                               |
|--|---|-------------------------------|
| Default value: 0 ReferenceFeedbackUnit     | Parameter type: Range, -999999.999 - 999999.999 ReferenceFeedbackUnit | Setup: All setups             |
| Conversion index: 0                        | Data type: Int32  | Change during operation: True |

## Parameter 36-35 Terminal X49/5 High Ref./Feedb. Value

Table 1328: Parameter 36-35 Terminal X49/5 High Ref./Feedb. Value

| 36-35 Terminal X49/5 High Ref./Feedb. Value |   |                               |
|---|---|-------------------------------|
| Default value: 100 ReferenceFeedbackUnit    | Parameter type: Range, -999999.999 - 999999.999 ReferenceFeedbackUnit | Setup: All setups             |
| Conversion index: 0                         | Data type: Int32  | Change during operation: True |

## Parameter 36-36 Term. X49/5 Filter Time Constant

Table 1329: Parameter 36-36 Term. X49/5 Filter Time Constant

| 36-36 Term. X49/5 Filter Time Constant |                                     |                               |
|--|-------------------------------------|-------------------------------|
| Default value: 0.001 s                 | Parameter type: Range, 0.001 - 10 s | Setup: All setups             |
| Conversion index: 0                    | Data type: Uint16                   | Change during operation: True |

Enter the filter time constant. This is a first-order digital low-pass filter time constant for suppressing electrical noise in terminal X49/5. A high time constant value improves dampening but also increases the time delay through the filter.

### 5.29.5 36-4\* Output X49/7

## N O T I C E

The following parameter is only available in FC 302:

- *Parameter 36-41 Terminal X49/7 Digital Output*

Use the parameters in this group to configure the mode of inputs and outputs of VLT® Programmable I/O MCB 115.

#### Parameter 36-40 Terminal X49/7 Analogue Output

**Table 1330: Parameter 36-40 Terminal X49/7 Analogue Output**

| 36-40 Terminal X49/7 Analogue Output |                        |                               |
|--------------------------------------|------------------------|-------------------------------|
| Default value: [0] No operation      | Parameter type: Option | Setup: All setups             |
| Conversion index: -                  | Data type: Uint8       | Change during operation: True |

Select the functionality of terminal X49/7.

| Option | Name                   | Description   |
|--------|------------------------|---|
| [0]*   | No operation           | Indicates no signal on the analog output.   |
| [52]   | MCO                    |   |
| [100]  | Output frequency       | 0 Hz = 0 mA; 100 Hz = 20 mA.  |
| [101]  | Reference              | <i>Parameter 3-00 Reference Range [Min - Max]</i> 0% = 0 mA; 100% = 20 mA<br><i>Parameter 3-00 Reference Range [-Max - Max]</i> -100% = 0 mA; 0% = 10 mA; +100% = 20 mA.  |
| [102]  | Feedback               |   |
| [103]  | Motor current          | The value is taken from <i>parameter 16-37 Inv. Max. Current</i> . The inverter maximum current (160% current) is equal to 20 mA.<br><b>Example:</b> Inverter normal current (11 kW) is 24 A. 160%=38.4 A. Motor normal current is 22 A, the readout is 11.46 mA.<br>$\frac{20 \text{ mA} \times 22 \text{ A}}{38.4 \text{ A}} = 11.46 \text{ mA}$<br>When the normal motor current is equal to 20 mA, the output setting of <i>parameter 6-52 Terminal 42 Output Max Scale</i> is:<br>$\frac{I_{VLT, MAX} \times 100}{I_{Motor, Nom}} = \frac{38.4 \times 100}{22} = 175 \%$ |
| [104]  | Torque rel to limit    | The torque setting is related to the setting in <i>parameter 4-16 Torque Limit Motor Mode</i> .   |
| [105]  | Torque relate to rated | The torque is related to the motor torque setting.  |
| [106]  | Power                  | Taken from <i>parameter 1-20 Motor Power [kW]</i> .   |
| [107]  | Speed                  | Taken from <i>parameter 3-03 Maximum Reference</i> . 20 mA equals the value in <i>parameter 3-03 Maximum Reference</i> .  |
| [108]  | Torque                 | Torque reference related to 160% torque.  |
| [109]  | Max out freq           | 0 Hz = 0 mA, <i>parameter 4-19 Max Output Frequency</i> = 20 mA.  |

| Option | Name               | Description  |
|--------|--------------------|--|
| [113]  | PID clamped output |  |
| [117]  | Shaft power        |  |
| [119]  | Torque % lim       |  |
| [123]  | Speed both dir     |  |
| [135]  | Torq.% nom 4-20mA  | The torque setting is related to the motor torque setting.   |
| [139]  | Bus ctrl           | An output value set from fieldbus process data. The output works independently of internal functions in the drive. |
| [141]  | Bus ctrl t.o.      | <i>Parameter 4-54 Warning Reference Low</i> defines the behavior of the analog output in case of fieldbus timeout. |
| [147]  | Main act val       |  |
| [158]  | Motor Volt.        |  |

Parameter 36-41 Terminal X49/7 Digital Output

Table 1331: Parameter 36-41 Terminal X49/7 Digital Output

| 36-41 Terminal X49/7 Digital Output |                        |                               |
|-------------------------------------|------------------------|-------------------------------|
| Default value: [0] No operation     | Parameter type: Option | Setup: All setups             |
| Conversion index: –                 | Data type: Uint8       | Change during operation: True |

| Option | Name                 | Description |
|--------|----------------------|-------------|
| [0]*   | No operation         |             |
| [1]    | Control ready        |             |
| [2]    | Drive ready          |             |
| [3]    | Drive rdy/rem ctrl   |             |
| [4]    | Enable/no warning    |             |
| [5]    | Running              |             |
| [6]    | Running/no warning   |             |
| [7]    | Run in range/no warn |             |
| [8]    | Run on ref/no warn   |             |
| [9]    | Alarm                |             |
| [10]   | Alarm or warning     |             |
| [11]   | At torque limit      |             |
| [12]   | Out of current range |             |
| [13]   | Below current, low   |             |
| [14]   | Above current, high  |             |

| Option | Name                   | Description |
|--------|------------------------|-------------|
| [15]   | Out of speed range     |             |
| [16]   | Below speed, low       |             |
| [17]   | Above speed, high      |             |
| [18]   | Out of feedb. range    |             |
| [19]   | Below feedback, low    |             |
| [20]   | Above feedback, high   |             |
| [21]   | Thermal warning        |             |
| [22]   | Ready, no thermal W    |             |
| [23]   | Remote, ready, no TW   |             |
| [24]   | Ready, Voltage OK      |             |
| [25]   | Reverse                |             |
| [26]   | Bus OK                 |             |
| [27]   | Torque limit & stop    |             |
| [28]   | Brake, no brake war    |             |
| [29]   | Brake ready, no fault  |             |
| [30]   | Brake fault (IGBT)     |             |
| [31]   | Relay 123              |             |
| [32]   | Mech brake ctrl        |             |
| [33]   | Safe stop active       |             |
| [35]   | External interlock     |             |
| [38]   | Motor feedback error   |             |
| [39]   | Tracking error         |             |
| [40]   | Out of ref range       |             |
| [41]   | Below reference, low   |             |
| [42]   | Above ref, high        |             |
| [43]   | Extended PID Limit     |             |
| [45]   | Bus ctrl.              |             |
| [46]   | Bus ctrl, 1 if timeout |             |
| [47]   | Bus ctrl, 0 if timeout |             |
| [50]   | On reference           |             |
| [51]   | MCO controlled         |             |
| [59]   | Remote, enable, no TW  |             |

| Option | Name                | Description |
|--------|---------------------|-------------|
| [60]   | Comparator 0        |             |
| [61]   | Comparator 1        |             |
| [62]   | Comparator 2        |             |
| [63]   | Comparator 3        |             |
| [64]   | Comparator 4        |             |
| [65]   | Comparator 5        |             |
| [66]   | Comparator 6        |             |
| [67]   | Comparator 7        |             |
| [68]   | Comparator 8        |             |
| [69]   | Comparator 9        |             |
| [70]   | Logic rule 0        |             |
| [71]   | Logic rule 1        |             |
| [72]   | Logic rule 2        |             |
| [73]   | Logic rule 3        |             |
| [74]   | Logic rule 4        |             |
| [75]   | Logic rule 5        |             |
| [76]   | Logic rule 6        |             |
| [77]   | Logic rule 7        |             |
| [78]   | Logic rule 8        |             |
| [79]   | Logic rule 9        |             |
| [80]   | SL digital output A |             |
| [81]   | SL digital output B |             |
| [82]   | SL digital output C |             |
| [83]   | SL digital output D |             |
| [84]   | SL digital output E |             |
| [85]   | SL digital output F |             |
| [90]   | kWh counter pulse   |             |
| [96]   | Reverse after ramp  |             |
| [98]   | Virtual master dir  |             |
| [120]  | Local ref active    |             |
| [121]  | Remote ref active   |             |
| [122]  | No alarm            |             |

| Option | Name                   | Description |
|--------|------------------------|-------------|
| [123]  | Start command activ    |             |
| [124]  | Running reverse        |             |
| [125]  | Drive in hand mode     |             |
| [126]  | Drive in auto mode     |             |
| [151]  | ATEX ETR cur. alarm    |             |
| [152]  | ATEX ETR freq. alarm   |             |
| [153]  | ATEX ETR cur. warning  |             |
| [154]  | ATEX ETR freq. warning |             |
| [173]  | 10Wh counter pulse     |             |
| [180]  | Clock fault            |             |
| [181]  | Prev. Maintenance      |             |
| [188]  | AHF Capacitor Connect  |             |
| [189]  | External Fan Control   |             |
| [190]  | Safe Function active   |             |
| [191]  | Safe Opt. Reset req.   |             |
| [192]  | RS Flipflop 0          |             |
| [193]  | RS Flipflop 1          |             |
| [194]  | RS Flipflop 2          |             |
| [195]  | RS Flipflop 3          |             |
| [196]  | RS Flipflop 4          |             |
| [197]  | RS Flipflop 5          |             |
| [198]  | RS Flipflop 6          |             |
| [199]  | RS Flipflop 7          |             |
| [221]  | IGBT-cooling           |             |
| [222]  | Homing OK              |             |
| [223]  | On target              |             |
| [224]  | Position limit         |             |
| [225]  | Position error         |             |
| [226]  | Touch on target        |             |
| [227]  | Touch activated        |             |
| [231]  | In power lim. mot.     |             |
| [232]  | In power lim. gen.     |             |

| Option | Name                    | Description |
|--------|-------------------------|-------------|
| [233]  | In power limit          |             |
| [234]  | PE power off            |             |
| [246]  | Emergency mode was act. |             |
| [247]  | Emergency mode          |             |
| [249]  | Emcy m. OPR unexpected  |             |
| [250]  | Emcy mode limits        |             |
| [254]  | Testing emcy mode       |             |

### Parameter 36-42 Terminal X49/7 Min Scale

Table 1332: Parameter 36-42 Terminal X49/7 Min Scale

| 36-42 Terminal X49/7 Min Scale |                                 |                               |
|--------------------------------|---------------------------------|-------------------------------|
| Default value: 0%              | Parameter type: Range, 0 - 200% | Setup: All setups             |
| Conversion index: -2           | Data type: Int16                | Change during operation: True |

Match the minimum output of terminal X49/7 with a required value. The required value is defined as a percentage of the value selected in *parameter 36-40 Terminal X49/7 Analogue Output*. To know more about how this parameter works, see *parameter 6-52 Terminal 42 Output Max Scale*. The following example describes how the drive uses this parameter. **Example:**

- *Parameter 36-03 Terminal X49/7 Mode = [0] Voltage 0–10 V.*
- *Parameter 36-40 Terminal X49/7 Analogue Output = [100] Output frequency.*
- *Parameter 4-19 Max Output Frequency = 200 Hz.*

Application requirement: If the output frequency is lower than 20 Hz, the output of terminal X49/7 should be 0 V. To fulfil the example requirement, enter 10% in *parameter 36-42 Terminal X49/7 Min. Scale*.

### Parameter 36-43 Terminal X49/7 Max. Scale

Table 1333: Parameter 36-43 Terminal X49/7 Max. Scale

| Parameter 36-43 Terminal X49/7 Max. Scale |                                 |                               |
|---|---------------------------------|-------------------------------|
| Default value: 100%                       | Parameter type: Range, 0 - 200% | Setup: All setups             |
| Conversion index: 0                       | Data type: Int16                | Change during operation: True |

Scale the maximum output of terminal X49/7. For example, the scaling is done for the following reasons:

- To provide an output value lower than the maximum possible value.
- To provide the full signal range using output values lower than a certain limit.

To know more about how this parameter works, see *parameter 6-52 Terminal 42 Output Max Scale*. **Example:**

- *Parameter 36-03 Terminal X49/7 Mode = [0] Voltage 0–10 V*
- *Parameter 36-40 Terminal X49/7 Analogue Output = [100] Output Frequency.*
- *Parameter 4-19 Max Output Frequency = 200 Hz.*

**Example case 1:** 5 V maximum output is required when the output frequency is 200 Hz. *Parameter 36-43 Terminal X49/7 Max. Scale* x 100% = 200%. **Example case 2:** 10 V maximum output is required when the output frequency is 150 Hz (75% of the maximum output frequency). *Parameter 36-43 Terminal X49/7 Max. Scale* = 75%.



Parameter 36-44 Terminal X49/7 Bus Ctrl

Table 1334: Parameter 36-44 Terminal X49/7 Bus Ctrl

| 36-44 Terminal X49/7 Bus Ctrl |                                 |                               |
|-------------------------------|---------------------------------|-------------------------------|
| Default value: 0%             | Parameter type: Range, 0 - 100% | Setup: All setups             |
| Conversion index: 0           | Data type: N2                   | Change during operation: True |

This parameter contains the output level of terminal X49/7 if the terminal is controlled by bus.

Parameter 36-45 Terminal X49/7 Timeout Preset

Table 1335: Parameter 36-45 Terminal X49/7 Timeout Preset

| 36-45 Terminal X49/7 Timeout Preset |                                 |                               |
|-------------------------------------|---------------------------------|-------------------------------|
| Default value: 0%                   | Parameter type: Range, 0 - 100% | Setup: 1 setup                |
| Conversion index: 0                 | Data type: Uint16               | Change during operation: True |

The drive sends the value of this parameter to the output terminal when the terminal is controlled by a fieldbus and a timeout is detected.

### 5.29.6 36-5\* Output X49/9

Use the parameters in this group to configure the mode of inputs and outputs of VLT® Programmable I/O MCB 115.

|   |  |  |
|---|--|--|
| <b>NOTICE</b>   |  |  |
| The following parameter is only available in FC 302:    |  |  |
| – <i>Parameter 36-51 Terminal X49/9 Digital Output.</i> |  |  |

Parameter 36-50 Terminal X49/9 Analogue Output

Table 1336: Parameter 36-50 Terminal X49/9 Analogue Output

| 36-50 Terminal X49/9 Analogue Output |                        |                               |
|--------------------------------------|------------------------|-------------------------------|
| Default value: [0] No operation      | Parameter type: Option | Setup: All setups             |
| Conversion index: –                  | Data type: Uint8       | Change during operation: True |

Select the functionality of terminal X49/9.

| Option | Name             | Description   |
|--------|------------------|---|
| [0]*   | No operation     | Indicates no signal on the analog output.   |
| [52]   | MCO              |   |
| [100]  | Output frequency | 0 Hz = 0 mA; 100 Hz = 20 mA.  |
| [101]  | Reference        | <i>Parameter 3-00 Reference Range [Min - Max]</i> 0% = 0 mA; 100% = 20 mA<br><i>Parameter 3-00 Reference Range [-Max - Max]</i> -100% = 0 mA; 0% = 10 mA; +100% = 20 mA.  |
| [102]  | Feedback         |   |
| [103]  | Motor current    | The value is taken from <i>parameter 16-37 Inv. Max. Current</i> . The inverter maximum current (160% current) is equal to 20 mA.<br><b>Example:</b> Inverter normal current (11 kW) is 24 A. 160%=38.4 A. Motor normal current is 22 A, the readout is 11.46 mA. |

| Option | Name                   | Description  |
|--------|------------------------|--|
|        |                        | $\frac{20 \text{ mA} \times 22 \text{ A}}{38.4 \text{ A}} = 11.46 \text{ mA}$ <p>When the normal motor current is equal to 20 mA, the output setting of <i>parameter 6-52 Terminal 42 Output Max Scale</i> is:</p> $\frac{I_{\text{VLT,MAX}} \times 100}{I_{\text{Motor, Nom}}} = \frac{38.4 \times 100}{22} = 175 \%$ |
| [104]  | Torque rel to limit    | The torque setting is related to the setting in <i>parameter 4-16 Torque Limit Motor Mode</i> .  |
| [105]  | Torque relate to rated | The torque is related to the motor torque setting.   |
| [106]  | Power                  | Taken from <i>parameter 1-20 Motor Power [kW]</i> .  |
| [107]  | Speed                  | Taken from <i>parameter 3-03 Maximum Reference</i> . 20 mA equals the value in <i>parameter 3-03 Maximum Reference</i> .   |
| [108]  | Torque                 | Torque reference related to 160% torque.   |
| [109]  | Max out freq           | 0 Hz = 0 mA, <i>parameter 4-19 Max Output Frequency</i> = 20 mA.   |
| [113]  | PID clamped output     |  |
| [117]  | Shaft power            |  |
| [119]  | Torque % lim           |  |
| [123]  | Speed both dir         |  |
| [135]  | Torq.% nom 4-20mA      | The torque setting is related to the motor torque setting.   |
| [139]  | Bus ctrl               | An output value set from fieldbus process data. The output works independently of internal functions in the drive.   |
| [141]  | Bus ctrl t.o.          | <i>Parameter 4-54 Warning Reference Low</i> defines the behavior of the analog output in case of fieldbus timeout.   |
| [147]  | Main act val           |  |
| [158]  | Motor Volt.            |  |

## Parameter 36-51 Terminal X49/9 Digital Output

Table 1337: Parameter 36-51 Terminal X49/9 Digital Output

| 36-51 Terminal X49/9 Digital Output |                        |                               |
|-------------------------------------|------------------------|-------------------------------|
| Default value: [0] No operation     | Parameter type: Option | Setup: All setups             |
| Conversion index: –                 | Data type: Uint8       | Change during operation: True |

| Option | Name          | Description |
|--------|---------------|-------------|
| [0]*   | No operation  |             |
| [1]    | Control ready |             |
| [2]    | Drive ready   |             |

| Option | Name                  | Description |
|--------|-----------------------|-------------|
| [3]    | Drive rdy/rem ctrl    |             |
| [4]    | Enable/no warning     |             |
| [5]    | Running               |             |
| [6]    | Running/no warning    |             |
| [7]    | Run in range/no warn  |             |
| [8]    | Run on ref/no warn    |             |
| [9]    | Alarm                 |             |
| [10]   | Alarm or warning      |             |
| [11]   | At torque limit       |             |
| [12]   | Out of current range  |             |
| [13]   | Below current, low    |             |
| [14]   | Above current, high   |             |
| [15]   | Out of speed range    |             |
| [16]   | Below speed, low      |             |
| [17]   | Above speed, high     |             |
| [18]   | Out of feedb. range   |             |
| [19]   | Below feedback, low   |             |
| [20]   | Above feedback, high  |             |
| [21]   | Thermal warning       |             |
| [22]   | Ready,no thermal W    |             |
| [23]   | Remote,ready, no TW   |             |
| [24]   | Ready, Voltage OK     |             |
| [25]   | Reverse               |             |
| [26]   | Bus OK                |             |
| [27]   | Torque limit & stop   |             |
| [28]   | Brake, no brake war   |             |
| [29]   | Brake ready, no fault |             |
| [30]   | Brake fault (IGBT)    |             |
| [31]   | Relay 123             |             |
| [32]   | Mech brake ctrl       |             |
| [33]   | Safe stop active      |             |
| [35]   | External interlock    |             |

| Option | Name                   | Description |
|--------|------------------------|-------------|
| [38]   | Motor feedback error   |             |
| [39]   | Tracking error         |             |
| [40]   | Out of ref range       |             |
| [41]   | Below reference, low   |             |
| [42]   | Above ref, high        |             |
| [43]   | Extended PID Limit     |             |
| [45]   | Bus ctrl.              |             |
| [46]   | Bus ctrl, 1 if timeout |             |
| [47]   | Bus ctrl, 0 if timeout |             |
| [50]   | On reference           |             |
| [51]   | MCO controlled         |             |
| [59]   | Remote, enable, no TW  |             |
| [60]   | Comparator 0           |             |
| [61]   | Comparator 1           |             |
| [62]   | Comparator 2           |             |
| [63]   | Comparator 3           |             |
| [64]   | Comparator 4           |             |
| [65]   | Comparator 5           |             |
| [66]   | Comparator 6           |             |
| [67]   | Comparator 7           |             |
| [68]   | Comparator 8           |             |
| [69]   | Comparator 9           |             |
| [70]   | Logic rule 0           |             |
| [71]   | Logic rule 1           |             |
| [72]   | Logic rule 2           |             |
| [73]   | Logic rule 3           |             |
| [74]   | Logic rule 4           |             |
| [75]   | Logic rule 5           |             |
| [76]   | Logic rule 6           |             |
| [77]   | Logic rule 7           |             |
| [78]   | Logic rule 8           |             |
| [79]   | Logic rule 9           |             |

| Option | Name                   | Description |
|--------|------------------------|-------------|
| [80]   | SL digital output A    |             |
| [81]   | SL digital output B    |             |
| [82]   | SL digital output C    |             |
| [83]   | SL digital output D    |             |
| [84]   | SL digital output E    |             |
| [85]   | SL digital output F    |             |
| [90]   | kWh counter pulse      |             |
| [96]   | Reverse after ramp     |             |
| [98]   | Virtual master dir     |             |
| [120]  | Local ref active       |             |
| [121]  | Remote ref active      |             |
| [122]  | No alarm               |             |
| [123]  | Start command activ    |             |
| [124]  | Running reverse        |             |
| [125]  | Drive in hand mode     |             |
| [126]  | Drive in auto mode     |             |
| [151]  | ATEX ETR cur. alarm    |             |
| [152]  | ATEX ETR freq. alarm   |             |
| [153]  | ATEX ETR cur. warning  |             |
| [154]  | ATEX ETR freq. warning |             |
| [173]  | 10Wh counter pulse     |             |
| [180]  | Clock fault            |             |
| [181]  | Prev. Maintenance      |             |
| [188]  | AHF Capacitor Connect  |             |
| [189]  | External Fan Control   |             |
| [190]  | Safe Function active   |             |
| [191]  | Safe Opt. Reset req.   |             |
| [192]  | RS Flipflop 0          |             |
| [193]  | RS Flipflop 1          |             |
| [194]  | RS Flipflop 2          |             |
| [195]  | RS Flipflop 3          |             |
| [196]  | RS Flipflop 4          |             |

| Option | Name                  | Description |
|--------|-----------------------|-------------|
| [197]  | RS Flipflop 5         |             |
| [198]  | RS Flipflop 6         |             |
| [199]  | RS Flipflop 7         |             |
| [221]  | IGBT-cooling          |             |
| [222]  | Homing OK             |             |
| [223]  | On target             |             |
| [224]  | Position limit        |             |
| [225]  | Position error        |             |
| [226]  | Touch on target       |             |
| [227]  | Touch activated       |             |
| [231]  | In power lim. mot.    |             |
| [232]  | In power lim. gen.    |             |
| [233]  | In power limit        |             |
| [234]  | PE power off          |             |
| [246]  | Emcy mode was act.    |             |
| [247]  | Emergency mode        |             |
| [249]  | Emcy m OPR unexpected |             |
| [250]  | Emcy mode limits      |             |
| [254]  | Testing emcy mode     |             |

## Parameter 36-52 Terminal X49/9 Min. Scale

Table 1338: Parameter 36-52 Terminal X49/9 Min. Scale

| 36-52 Terminal X49/9 Min. Scale |                                 |                               |
|---------------------------------|---------------------------------|-------------------------------|
| Default value: 0%               | Parameter type: Range, 0 - 200% | Setup: All setups             |
| Conversion index: 0             | Data type: Int16                | Change during operation: True |

Match the minimum output of terminal X49/9 with a required value. The required value is defined as a percentage of the value selected in *parameter 36-50 Terminal X49/9 Analogue Output*. To know more about how this parameter works, see *parameter 6-52 Terminal 42 Output Max Scale*. The following example describes how the drive uses this parameter. **Example:**

- *Parameter 36-04 Terminal X49/9 Mode* = [0] Voltage 0–10 V.
- *Parameter 36-50 Terminal X49/9 Analogue Output* = [100] Output frequency.
- *Parameter 4-19 Max Output Frequency* = 200 Hz.

Application requirement: If the output frequency is lower than 20 Hz, the output of terminal X49/9 should be 0 V. To fulfil the example requirement, enter 10% in *parameter 36-52 Terminal X49/9 Min. Scale*.

## Parameter 36-53 Terminal X49/9 Max. Scale

Table 1339: Parameter 36-53 Terminal X49/9 Max. Scale

| 36-53 Terminal X49/9 Max. Scale |                                 |                               |
|---------------------------------|---------------------------------|-------------------------------|
| Default value: 100%             | Parameter type: Range, 0 - 200% | Setup: All setups             |
| Conversion index: 0             | Data type: Int16                | Change during operation: True |

Scale the maximum output of terminal X49/9. For example, the scaling is done for the following reasons:

- To provide an output value lower than the maximum possible value.
- To provide the full signal range using output values lower than a certain limit.

To know more about how this parameter works, see *parameter 6-52 Terminal 42 Output Max Scale*. **Example:**

- *Parameter 36-04 Terminal X49/9 Mode = [0] Voltage 0–10 V*
- *Parameter 36-50 Terminal X49/9 Analogue Output = [100] Output Frequency.*
- *Parameter 4-19 Max Output Frequency = 200 Hz.*

**Example case 1:** 5 V maximum output is required when the output frequency is 200 Hz. *Parameter 36-53 Terminal X49/9 Max. Scale* x 100% = 200%. **Example case 2:** 10 V maximum output is required when the output frequency is 150 Hz (75% of the maximum output frequency). *Parameter 36-53 Terminal X49/9 Max. Scale* = 75%.

## Parameter 36-54 Terminal X49/9 Bus Ctrl

Table 1340: Parameter 36-54 Terminal X49/9 Bus Ctrl

| 36-54 Terminal X49/9 Bus Ctrl |                                 |                               |
|-------------------------------|---------------------------------|-------------------------------|
| Default value: 0%             | Parameter type: Range, 0 - 100% | Setup: All setups             |
| Conversion index: 0           | Data type: N2                   | Change during operation: True |

This parameter contains the output level of terminal X49/9 if the terminal is controlled by bus.

## Parameter 36-55 Terminal X49/9 Timeout Preset

Table 1341: Parameter 36-55 Terminal X49/9 Timeout Preset

| 36-55 Terminal X49/9 Timeout Preset |                                 |                               |
|-------------------------------------|---------------------------------|-------------------------------|
| Default value: 0%                   | Parameter type: Range, 0 - 100% | Setup: 1 setup                |
| Conversion index: 0                 | Data type: Uint16               | Change during operation: True |

The drive sends the value of this parameter to the output terminal when the terminal is controlled by a fieldbus and a timeout is detected.

## 5.29.7 36-6\* Output X49/11

Use the parameters in this group to configure the mode of inputs and outputs of VLT® Programmable I/O MCB 115.

## NOTICE

The following parameter is only available in FC 302:

- *Parameter 36-61 Terminal X49/11 Digital Output.*

## Parameter 36-60 Terminal X49/11 Analogue Output

Table 1342: Parameter 36-60 Terminal X49/11 Analogue Output

| 36-60 Terminal X49/11 Analogue Output |                        |                               |
|---------------------------------------|------------------------|-------------------------------|
| Default value: [0] No operation       | Parameter type: Option | Setup: All setups             |
| Conversion index: –                   | Data type: Uint8       | Change during operation: True |

Select the functionality of terminal X49/11.

| Option | Name                   | Description  |
|--------|------------------------|--|
| [0]*   | No operation           | Indicates no signal on the analog output.  |
| [52]   | MCO                    |  |
| [100]  | Output frequency       | 0 Hz = 0 mA; 100 Hz = 20 mA.   |
| [101]  | Reference              | <i>Parameter 3-00 Reference Range [Min - Max]</i> 0% = 0 mA; 100% = 20 mA<br><i>Parameter 3-00 Reference Range [-Max - Max]</i> -100% = 0 mA; 0% = 10 mA; +100% = 20 mA.   |
| [102]  | Feedback               |  |
| [103]  | Motor current          | <p>The value is taken from <i>parameter 16-37 Inv. Max. Current</i>. The inverter maximum current (160% current) is equal to 20 mA.</p> <p><b>Example:</b> Inverter normal current (11 kW) is 24 A. 160 %=38.4 A. Motor normal current is 22 A, the readout is 11.46 mA.</p> $\frac{20 \text{ mA} \times 22 \text{ A}}{38.4 \text{ A}} = 11.46 \text{ mA}$ <p>When the normal motor current is equal to 20 mA, the output setting of <i>parameter 6-52 Terminal 42 Output Max Scale</i> is:</p> $\frac{I_{VLT,MAX} \times 100}{I_{Motor,Nom}} = \frac{38.4 \times 100}{22} = 175 \%$ |
| [104]  | Torque rel to limit    | The torque setting is related to the setting in <i>parameter 4-16 Torque Limit Motor Mode</i> .  |
| [105]  | Torque relate to rated | The torque is related to the motor torque setting.   |
| [106]  | Power                  | Taken from <i>parameter 1-20 Motor Power [kW]</i> .  |
| [107]  | Speed                  | Taken from <i>parameter 3-03 Maximum Reference</i> . 20 mA equals the value in <i>parameter 3-03 Maximum Reference</i> .   |
| [108]  | Torque                 | Torque reference related to 160% torque.   |
| [109]  | Max out freq           | 0 Hz = 0 mA, <i>parameter 4-19 Max Output Frequency</i> = 20 mA.   |
| [113]  | PID clamped output     |  |
| [117]  | Shaft power            |  |
| [119]  | Torque % lim           |  |
| [123]  | Speed both dir         |  |
| [139]  | Bus ctrl               | An output value set from fieldbus process data. The output works independently of internal functions in the drive.   |
| [141]  | Bus ctrl t.o.          | <i>Parameter 4-54 Warning Reference Low</i> defines the behavior of the analog output in case of fieldbus timeout.   |
| [147]  | Main act val           |  |
| [158]  | Motor Volt.            |  |



## Parameter 36-61 Terminal X49/11 Digital Output

Table 1343: Parameter 36-61 Terminal X49/11 Digital Output

| 36-61 Terminal X49/11 Digital Output |                        |                               |
|--------------------------------------|------------------------|-------------------------------|
| Default value: [0] No operation      | Parameter type: Option | Setup: All setups             |
| Conversion index: –                  | Data type: Uint8       | Change during operation: True |

| Option | Name                 | Description |
|--------|----------------------|-------------|
| [0]*   | No operation         |             |
| [1]    | Control ready        |             |
| [2]    | Drive ready          |             |
| [3]    | Drive rdy/rem ctrl   |             |
| [4]    | Enable/no warning    |             |
| [5]    | Running              |             |
| [6]    | Running/no warning   |             |
| [7]    | Run in range/no warn |             |
| [8]    | Run on ref/no warn   |             |
| [9]    | Alarm                |             |
| [10]   | Alarm or warning     |             |
| [11]   | At torque limit      |             |
| [12]   | Out of current range |             |
| [13]   | Below current, low   |             |
| [14]   | Above current, high  |             |
| [15]   | Out of speed range   |             |
| [16]   | Below speed, low     |             |
| [17]   | Above speed, high    |             |
| [18]   | Out of feedb. range  |             |
| [19]   | Below feedback, low  |             |
| [20]   | Above feedback, high |             |
| [21]   | Thermal warning      |             |
| [22]   | Ready,no thermal W   |             |
| [23]   | Remote,ready, no TW  |             |
| [24]   | Ready, Voltage OK    |             |
| [25]   | Reverse              |             |
| [26]   | Bus OK               |             |
| [27]   | Torque limit & stop  |             |

| Option | Name                   | Description |
|--------|------------------------|-------------|
| [28]   | Brake, no brake war    |             |
| [29]   | Brake ready, no fault  |             |
| [30]   | Brake fault (IGBT)     |             |
| [31]   | Relay 123              |             |
| [32]   | Mech brake ctrl        |             |
| [33]   | Safe stop active       |             |
| [35]   | External interlock     |             |
| [38]   | Motor feedback error   |             |
| [39]   | Tracking error         |             |
| [40]   | Out of ref range       |             |
| [41]   | Below reference, low   |             |
| [42]   | Above ref, high        |             |
| [43]   | Extended PID Limit     |             |
| [45]   | Bus ctrl.              |             |
| [46]   | Bus ctrl, 1 if timeout |             |
| [47]   | Bus ctrl, 0 if timeout |             |
| [50]   | On reference           |             |
| [51]   | MCO controlled         |             |
| [59]   | Remote, enable, no TW  |             |
| [60]   | Comparator 0           |             |
| [61]   | Comparator 1           |             |
| [62]   | Comparator 2           |             |
| [63]   | Comparator 3           |             |
| [64]   | Comparator 4           |             |
| [65]   | Comparator 5           |             |
| [66]   | Comparator 6           |             |
| [67]   | Comparator 7           |             |
| [68]   | Comparator 8           |             |
| [69]   | Comparator 9           |             |
| [70]   | Logic rule 0           |             |
| [71]   | Logic rule 1           |             |
| [72]   | Logic rule 2           |             |

| Option | Name                   | Description |
|--------|------------------------|-------------|
| [73]   | Logic rule 3           |             |
| [74]   | Logic rule 4           |             |
| [75]   | Logic rule 5           |             |
| [76]   | Logic rule 6           |             |
| [77]   | Logic rule 7           |             |
| [78]   | Logic rule 8           |             |
| [79]   | Logic rule 9           |             |
| [80]   | SL digital output A    |             |
| [81]   | SL digital output B    |             |
| [82]   | SL digital output C    |             |
| [83]   | SL digital output D    |             |
| [84]   | SL digital output E    |             |
| [85]   | SL digital output F    |             |
| [90]   | kWh counter pulse      |             |
| [96]   | Reverse after ramp     |             |
| [98]   | Virtual master dir     |             |
| [120]  | Local ref active       |             |
| [121]  | Remote ref active      |             |
| [122]  | No alarm               |             |
| [123]  | Start command activ    |             |
| [124]  | Running reverse        |             |
| [125]  | Drive in hand mode     |             |
| [126]  | Drive in auto mode     |             |
| [151]  | ATEX ETR cur. alarm    |             |
| [152]  | ATEX ETR freq. alarm   |             |
| [153]  | ATEX ETR cur. warning  |             |
| [154]  | ATEX ETR freq. warning |             |
| [173]  | 10Wh counter pulse     |             |
| [180]  | Clock fault            |             |
| [181]  | Prev. Maintenance      |             |
| [188]  | AHF Capacitor Connect  |             |
| [189]  | External Fan Control   |             |

| Option | Name                   | Description |
|--------|------------------------|-------------|
| [190]  | Safe Function active   |             |
| [191]  | Safe Opt. Reset req.   |             |
| [192]  | RS Flipflop 0          |             |
| [193]  | RS Flipflop 1          |             |
| [194]  | RS Flipflop 2          |             |
| [195]  | RS Flipflop 3          |             |
| [196]  | RS Flipflop 4          |             |
| [197]  | RS Flipflop 5          |             |
| [198]  | RS Flipflop 6          |             |
| [199]  | RS Flipflop 7          |             |
| [221]  | IGBT-cooling           |             |
| [222]  | Homing OK              |             |
| [223]  | On target              |             |
| [224]  | Position limit         |             |
| [225]  | Position error         |             |
| [226]  | Touch on target        |             |
| [227]  | Touch activated        |             |
| [231]  | In power lim. mot.     |             |
| [232]  | In power lim. gen.     |             |
| [233]  | In power limit         |             |
| [234]  | PE power off           |             |
| [246]  | Emcy mode was act.     |             |
| [247]  | Emergency mode         |             |
| [249]  | Emcy m. OPR unexpected |             |
| [250]  | Emcy mode limits       |             |
| [254]  | Testing emcy mode      |             |

## Parameter 36-62 Terminal X49/11 Min. Scale

Table 1344: Parameter 36-62 Terminal X49/11 Min. Scale

| 36-62 Terminal X49/11 Min. Scale |                                 |                               |
|----------------------------------|---------------------------------|-------------------------------|
| Default value: 0%                | Parameter type: Range, 0 - 200% | Setup: All setups             |
| Conversion index: 0              | Data type: Int16                | Change during operation: True |

Match the minimum output of terminal X49/11 with a required value. The required value is defined as a percentage of the value selected in *parameter 36-60 Terminal X49/11 Analogue Output*. To know more about how this parameter works, see *parameter 6-52 Terminal 42 Output Max Scale*. The following example describes how the drive uses this parameter. **Example:**

- *Parameter 36-05 Terminal X49/16 Mode = [0] Voltage 0–10 V.*
- *Parameter 36-50 Terminal X49/11 Analogue Output = [100] Output frequency.*
- *Parameter 4-19 Max Output Frequency = 200 Hz.*

Application requirement: If the output frequency is lower than 20 Hz, the output of terminal X49/9 should be 0 V. To fulfil the example requirement, enter 10% in *parameter 36-62 Terminal X49/11 Min. Scale*.

Parameter 36-63 Terminal X49/11 Max. Scale

Table 1345: Parameter 36-63 Terminal X49/11 Max. Scale

| 36-63 Terminal X49/11 Max. Scale |                                 |                               |
|----------------------------------|---------------------------------|-------------------------------|
| Default value: 100%              | Parameter type: Range, 0 - 200% | Setup: All setups             |
| Conversion index: 0              | Data type: Int16                | Change during operation: True |

Scale the maximum output of terminal X49/11. For example, the scaling is done for the following reasons:

- To provide an output value lower than the maximum possible value.
- To provide the full signal range using output values lower than a certain limit.

To know more about how this parameter works, see *parameter 6-52 Terminal 42 Output Max Scale*. **Example:**

- *Parameter 36-05 Terminal X49/11 Mode = [0] Voltage 0–10 V*
- *Parameter 36-60 Terminal X49/11 Analogue Output = [100] Output Frequency.*
- *Parameter 4-19 Max Output Frequency = 200 Hz.*

**Example case 1:** 5 V maximum output is required when the output frequency is 200 Hz. *Parameter 36-63 Terminal X49/11 Max. Scale* x 100% = 200%. **Example case 2:** 10 V maximum output is required when the output frequency is 150 Hz (75% of the maximum output frequency). *Parameter 36-63 Terminal X49/11 Max. Scale = 75%*.

Parameter 36-64 Terminal X49/11 Bus Ctrl

Table 1346: Parameter 36-64 Terminal X49/11 Bus Ctrl

| 36-64 Terminal X49/11 Bus Ctrl |                                 |                               |
|--------------------------------|---------------------------------|-------------------------------|
| Default value: 0%              | Parameter type: Range, 0 - 100% | Setup: All setups             |
| Conversion index: 0            | Data type: N2                   | Change during operation: True |

This parameter contains the output level of terminal X49/11 if the terminal is controlled by bus.

Parameter 36-55 Terminal X49/9 Timeout Preset

Table 1347: Parameter 36-55 Terminal X49/9 Timeout Preset

| 36-55 Terminal X49/9 Timeout Preset |                                 |                               |
|-------------------------------------|---------------------------------|-------------------------------|
| Default value: 0%                   | Parameter type: Range, 0 - 100% | Setup: 1 setup                |
| Conversion index: 0                 | Data type: UInt16               | Change during operation: True |

The drive sends the value of this parameter to the output terminal when the terminal is controlled by a fieldbus and a timeout is detected.

## 5.30 Parameter Group 40-\*\* Special Settings

### 5.30.1 40-1\* Aux. Functions Control

#### Parameter 40-10 Kin. Back-up UdcRef

Table 1348: Parameter 40-10 Kin. Back-up UdcRef

| 40-10 Kin. Back-up UdcRef   |                                     |                               |
|-----------------------------|-------------------------------------|-------------------------------|
| Default value: Size related | Parameter type: Range, 300 - 1080 V | Setup: All setups             |
| Conversion index: 0         | Data type: Uint16                   | Change during operation: True |

Set DC-link voltage for kinetic back-up mode. To set a higher DC-link voltage for riding through an unbalanced fault, set *parameter 14-10 Mains Failure* to [4] *Kinetic back-up* and leave *parameter 40-14 Mains Loss Duration* as set. If ride through is not required, set *parameter 14-10 Mains Failure* to either [1] *Ctrl. ramp-down*, [2] *Ctrl. ramp-down, trip*, or [5] *Kinetic back-up, trip*.

#### Parameter 40-11 Kin. Back-up Integral Time

Table 1349: Parameter 40-11 Kin. Back-up Integral Time

| 40-11 Kin. Back-up Integral Time |                                       |                               |
|----------------------------------|---------------------------------------|-------------------------------|
| Default value: Size related      | Parameter type: Range, 0.001 - 1000 s | Setup: All setups             |
| Conversion index: -3             | Data type: Uint16                     | Change during operation: True |

The kinetic back-up controller integral time value enables optimizing the DC-link voltage response. If there is external capacitance on the DC link, increase the value. To obtain fast control response, decrease the value. However, if the value is too low, the process becomes unstable.

#### Parameter 40-12 Kin. Back-up Lead Filter Time

Table 1350: Parameter 40-12 Kin. Back-up Lead Filter Time

| 40-12 Kin. Back-up Lead Filter Time |                                       |                               |
|-------------------------------------|---------------------------------------|-------------------------------|
| Default value: Size related         | Parameter type: Range, 0.001 - 1000 s | Setup: All setups             |
| Conversion index: -3                | Data type: Uint16                     | Change during operation: True |

## N O T I C E

This parameter is only valid in VVC+ control.

This parameter specifies the kinetic back-up controller lead filter time. Increase this value to ensure stable DC-link voltage control for high-inertia applications.

#### Parameter 40-13 Kin. Back-up Min Run Time

Table 1351: Parameter 40-13 Kin. Back-up Min Run Time

| 40-13 Kin. Back-up Min Run Time |                                    |                               |
|---------------------------------|------------------------------------|-------------------------------|
| Default value: Size related     | Parameter type: Range, 0.005 - 2 s | Setup: All setups             |
| Conversion index: -3            | Data type: Uint16                  | Change during operation: True |

Minimum runtime of the kinetic back-up. Kinetic back-up control must run during this time, even mains voltage can come back within this time span. The purpose of this function is to avoid that the drive frequently changes in and out of kinetic back-up mode, if fluctuating mains voltage occurs.

## Parameter 40-14 Mains Loss Duration

Table 1352: Parameter 40-14 Mains Loss Duration

| 40-14 Mains Loss Duration |                                       |                               |
|---------------------------|---------------------------------------|-------------------------------|
| Default value: 60.00 s    | Parameter type: Range, 0.05 - 60.00 s | Setup: All setups             |
| Conversion index: -2      | Data type: Uint16                     | Change during operation: True |

Enter the maximum value of mains loss duration. When *parameter 14-10 Mains Failure = [4] Kinetic Back-up*, the DC-link voltage boosts to the value set in *Parameter 40-10 Kin. Back-up UdcRef*. Then the drive returns to normal operation. The drive allows 2 successive mains faults. A 3<sup>rd</sup> mains fault triggers a trip. Setting this parameter to 60 s disables the function.

## Parameter 40-15 Kin.Back-up Start Off

Table 1353: Parameter 40-15 Kin.Back-up Start Off

| 40-15 Kin.Back-up Start Off |   |                               |
|-----------------------------|---|-------------------------------|
| Default value: Size related | Parameter type: Range, -200.0 - 200.0 V | Setup: All setups             |
| Conversion index: -1        | Data type: Uint16                       | Change during operation: True |

Set the voltage offset to be added to the kinetic back-up reference to boost the gain when kinetic back-up is activated. This function is used in low-inertia applications.

## 5.30.2 40-2\* PM Motor Specific

### N O T I C E

The following parameters are only available in FC 302:

- *Parameter 40-28 Back EMF Protection*
- *Parameter 40-29 B-EMF Protection Log Readout*

## Parameter 40-28 Back EMF Protection

Table 1354: Parameter 40-28 Back EMF Protection

| 40-28 Back EMF Protection  |                        |                                |
|----------------------------|------------------------|--------------------------------|
| Default value: [1] Enabled | Parameter type: Option | Setup: All setups              |
| Conversion index: -        | Data type: Uint8       | Change during operation: False |

The drive is protected by default from Back EMF, which can be generated by IPM or SPM motor types due to calculated speed limitation. The actual limitation is based on *parameter 1-40 Back EMF at 1000 RPM* and protects the drive from motor-generated overvoltage.

### ⚠ C A U T I O N ⚠

By disabling the speed limitation, a risk of destructive effect on the IGBTs can be encountered when the drive loses the motor. If the function is disabled, ensure to protect the drive by other means to prevent motor-generated overvoltage.

| Option | Name     | Description |
|--------|----------|-------------|
| [0]    | Disabled |             |
| [1]*   | Enabled  |             |

## Parameter 40-29 B-EMF Protection Log Readout

Table 1355: Parameter 40-29 B-EMF Protection Log Readout

| 40-29 B-EMF Protection Log Readout |                                  |                               |
|------------------------------------|----------------------------------|-------------------------------|
| Default value: 0                   | Parameter type: Range, 0 - 65535 | Setup: All setups             |
| Conversion index: 0                | Data type: Uint16                | Change during operation: True |

Readout parameter to log events if the Back EMF has been enabled or disabled. The range of the readout parameter is between [0x0-0xFFFF] hex. The value indicates the bit pattern to identify the current state of Back EMF in the drive. Bit 1 is set: When Back EMF is enabled, the bit is set to 1. Once enabled the Back EMF cannot be reversed. Bit 1 and bit 2: Motor frequency exceeded Back EMF limitation. Bit 2 can be reversed. Bit 1, bit 2, and bit 3: The drive has been coasted as motor frequency exceeded the Back EMF limitation. Bit 1, bit 2, bit 3, bit 4: The drive has generated an overvoltage alarm because the drive has coasted as the motor frequency exceeded Back EMF limitation.

## 5.30.3 40-4\* Extend. Fault Log

Parameters in this group are array parameters, where up to 10 alarm logs can be viewed. [0] is the most recently logged data and [9] is the oldest. This parameter group provides details on reference, frequency, motor current, voltage, DC-link voltage, status, and control word values at the time an alarm occurred.

## Parameter 40-40 Fault Log: Ext. Reference

Table 1356: Parameter 40-40 Fault Log: Ext. Reference

| 40-40 Fault Log: Ext. Reference |  |                                |
|---------------------------------|--|--------------------------------|
| Default value: 0%               | Parameter type: Range, -200 - 200%, Array [10] | Setup: All setups              |
| Conversion index: -1            | Data type: Int16                               | Change during operation: False |

View the present reference value applied on impulse or analog basis when the logged event occurred.

## Parameter 40-41 Fault Log: Frequency

Table 1357: Parameter 40-41 Fault Log: Frequency

| 40-41 Fault Log: Frequency |  |                                |
|----------------------------|--|--------------------------------|
| Default value: 0 Hz        | Parameter type: Range, 0 - 6500 Hz, Array [10] | Setup: All setups              |
| Conversion index: -1       | Data type: Uint16                              | Change during operation: False |

View the actual motor frequency value when the logged event occurred.

## Parameter 40-42 Fault Log: Current

Table 1358: Parameter 40-42 Fault Log: Current

| 40-42 Fault Log: Current |  |                                |
|--------------------------|--|--------------------------------|
| Default value: 0 A       | Parameter type: Range, 0 - 10000 A, Array [10] | Setup: All setups              |
| Conversion index: 0      | Data type: Int32                               | Change during operation: False |

View the motor current measured when the logged event occurred.

## Parameter 40-43 Fault Log: Voltage

Table 1359: Parameter 40-43 Fault Log: Voltage

| 40-43 Fault Log: Voltage |   |                                |
|--------------------------|---|--------------------------------|
| Default value: 0 V       | Parameter type: Range, 0 - 6000 V, Array [10] | Setup: All setups              |
| Conversion index: 0      | Data type: Uint16                             | Change during operation: False |

View the motor voltage when the logged event occurred.



Parameter 40-44 Fault Log: DC Link Voltage

Table 1360: Parameter 40-44 Fault Log: DC Link Voltage

| 40-44 Fault Log: DC Link Voltage |  |                                |
|----------------------------------|--|--------------------------------|
| Default value: 0 V               | Parameter type: Range, 0 - 10000 V, Array [10] | Setup: All setups              |
| Conversion index: 0              | Data type: Uint16                              | Change during operation: False |

View the DC-link voltage when the logged event occurred.

Parameter 40-45 Fault Log: Control Word

Table 1361: Parameter 40-45 Fault Log: Control Word

| 40-45 Fault Log: Control Word |  |                                |
|-------------------------------|--|--------------------------------|
| Default value: 0              | Parameter type: Range, 0 - 65535, Array [10] | Setup: All setups              |
| Conversion index: 0           | Data type: V2                                | Change during operation: False |

View the control word sent from the drive when the logged event occurred.

Parameter 40-46 Fault Log: Status Word

Table 1362: Parameter 40-46 Fault Log: Status Word

| 40-46 Fault Log: Status Word |  |                                |
|------------------------------|--|--------------------------------|
| Default value: 0             | Parameter type: Range, 0 - 65535, Array [10] | Setup: All setups              |
| Conversion index: 0          | Data type: V2                                | Change during operation: False |

View the status word sent from the drive when the logged event occurred.

### 5.30.4 40-5\* Advanced Control Settings

Parameters for configuring the advanced motor control settings.

Parameter 40-50 Flux Sensorless Model Shift

Table 1363: Parameter 40-50 Flux Sensorless Model Shift

| 40-50 Flux Sensorless Model Shift |                        |                               |
|-----------------------------------|------------------------|-------------------------------|
| Default value: Size related       | Parameter type: Option | Setup: All setups             |
| Conversion index: -               | Data type: Uint8       | Change during operation: True |

Use this parameter to enable or disable the shifting between flux model 1 and flux model 2 at low speed. See also *parameter 1-66 Min. Current at Low Speed*.

| Option | Name | Description |
|--------|------|-------------|
| [0]    | Off  |             |
| [1]    | On   |             |

Parameter 40-51 Flux Sensorless Corr. Gain

Table 1364: Parameter 40-51 Flux Sensorless Corr. Gain

| 40-51 Flux Sensorless Corr. Gain |                                    |                               |
|----------------------------------|------------------------------------|-------------------------------|
| Default value: Size related      | Parameter type: Range, 0.1 - 200.0 | Setup: All setups             |
| Conversion index: -1             | Data type: Uint32                  | Change during operation: True |

Adjust the flux correction gain used at low speed.

## Parameter 40-52 Speed PID Anti Windup Gain

Table 1365: Parameter 40-52 Speed PID Anti Windup Gain

| 40-52 Speed PID Anti Windup Gain |                                 |                               |
|----------------------------------|---------------------------------|-------------------------------|
| Default value: Size related      | Parameter type: Range, 0 - 500% | Setup: All setups             |
| Conversion index: 0              | Data type: Int16                | Change during operation: True |

This Flux parameter is active in the drive when the following parameters are set to 1 of the values listed here:

- *Parameter 1-00 Configuration Mode*
  - [0] Speed open loop or
  - [1] Speed closed loop or
  - [4] Torque open loop
- *Parameter 1-01 Motor Control Principle*
  - [2] Flux sensorless or
  - [3] Flux w/motor feedback
- *Parameter 1-10 Motor Construction*
  - [0] Asynchron or
  - [1] PM, non-salient SPM or
  - [2] PM, salient IPM

## Parameter 40-53 Current PID Anti Windup Gain

Table 1366: Parameter 40-53 Current PID Anti Windup Gain

| 40-53 Current PID Anti Windup Gain |                                 |                               |
|------------------------------------|---------------------------------|-------------------------------|
| Default value: Size related        | Parameter type: Range, 0 - 500% | Setup: All setups             |
| Conversion index: 0                | Data type: Int16                | Change during operation: True |

This Flux parameter is active in the drive when the following parameters are set to 1 of the values listed here:

- *Parameter 1-00 Configuration Mode*
  - [0] Speed open loop or
  - [1] Speed closed loop or
  - [4] Torque open loop
- *Parameter 1-01 Motor Control Principle*
  - [2] Flux sensorless or
  - [3] Flux w/motor feedback
- *Parameter 1-10 Motor Construction*
  - [0] Asynchron or
  - [1] PM, non-salient SPM or
  - [2] PM, salient IPM

## Parameter 40-54 Flux /w Feedback Dynamic Mode

Table 1367: Parameter 40-54 Flux /w Feedback Dynamic Mode

| 40-54 Flux /w Feedback Dynamic Mode |                                   |                                |
|-------------------------------------|-----------------------------------|--------------------------------|
| Default value: [0] Off              | Parameter type: Option, array [2] | Setup: All setups              |
| Conversion index: -                 | Data type: Uint8                  | Change during operation: False |

The position and speed controllers are executed on the fastest control task (up to 7 kHz depending on the switching frequency) in flux with motor feedback for PM motors and on the 1 ms task for induction motors. In dynamic mode, the position and speed controllers are also executed on the fastest control task for induction motors. This mode significantly improves control performance for induction motors.

| Option | Name | Description                    |
|--------|------|--------------------------------|
| [0]*   | Off  | Dynamic mode is not activated. |
| [1]    | On   | Dynamic mode is activated.     |

#### Parameter 40-55 Modulation Index

Table 1368: Parameter 40-55 Modulation Index

| 40-55 Modulation Index |                                  |                               |
|------------------------|----------------------------------|-------------------------------|
| Default value: 100%    | Parameter type: Range, 80 - 106% | Setup: All setups             |
| Conversion index: 0    | Data type: Uint8                 | Change during operation: True |

### NOTICE

This parameter is for IPM and SPM motors in VVC+ control principle only.

Activate this parameter by setting *parameter 14-03 Overmodulation* to [2] *User Defined*. Use this parameter to set the maximum modulation index and thus trim the application, especially if running with high-power motors without sine-wave filters. Increasing the maximum modulation index increases the motor voltage and improves efficiency and stability. Setting the modulation index too high may lead to torque ripples on the motor shaft.

#### Parameter 40-58 Control Word Source Internal

Table 1369: Parameter 40-58 Control Word Source Internal

| 40-58 Control Word Source Internal |                        |                                |
|------------------------------------|------------------------|--------------------------------|
| Default value: [1] FC RS485        | Parameter type: Option | Setup: 2 setups                |
| Conversion index: -                | Data type: Uint8       | Change during operation: False |

| Option | Name      | Description |
|--------|-----------|-------------|
| [0]    | None      |             |
| [1]*   | FC RS485  |             |
| [2]    | FC USB    |             |
| [3]    | Option A  |             |
| [4]    | Option B  |             |
| [5]    | Option C0 |             |
| [6]    | Option C1 |             |

| Option | Name           | Description  |
|--------|----------------|--|
| [30]   | External Can   |  |
| [35]   | Option A fast  | <div style="text-align: center; background-color: #cccccc; padding: 5px;"><b>NOTICE</b></div> This option is only available in FC 302. |
| [37]   | Option C0 fast | <div style="text-align: center; background-color: #cccccc; padding: 5px;"><b>NOTICE</b></div> This option is only available in FC 302. |

### 5.31 Parameter Group 42-\*\* Safety Functions

The parameters in this parameter group are available when a safety option is installed in the drive. For information about the safety-related parameters, see the intallation guides for the safety options:

- VLT® Safety Option MCB 150/151 Installation Guide
- VLT® Safety Options MCB 152 Installation Guide

#### 5.31.1 42-0\* Speed Performance

##### Parameter 42-00 Speed Deviation Timer

Table 1370: Parameter 42-00 Speed Deviation Timer

| 42-00 Speed Deviation Timer |                                     |                                |
|-----------------------------|-------------------------------------|--------------------------------|
| Default value: 10 ms        | Parameter type: Range, 10 - 5000 ms | Setup: 2 setups                |
| Conversion index: -3        | Data type: Uint16                   | Change during operation: False |

Enter the time for which a speed deviation above 120 RPM between estimated and measured speed is allowed.

##### Parameter 42-01 Fast Ramp

Table 1371: Parameter 42-01 Fast Ramp

| 42-01 Fast Ramp       |                        |                                |
|-----------------------|------------------------|--------------------------------|
| Default value: [0] No | Parameter type: Option | Setup: 2 setups                |
| Conversion index: -   | Data type: Uint8       | Change during operation: False |

| Option | Name | Description |
|--------|------|-------------|
| [0]*   | No   |             |
| [1]    | Yes  |             |

#### 5.31.2 42-1\* Speed Monitoring

##### Parameter 42-10 Measured Speed Source

Table 1372: Parameter 42-10 Measured Speed Source

| 42-10 Measured Speed Source |                        |                                |
|-----------------------------|------------------------|--------------------------------|
| Default value: Size related | Parameter type: Option | Setup: 1 setup                 |
| Conversion index: -         | Data type: Uint8       | Change during operation: False |

| Option | Name        | Description |
|--------|-------------|-------------|
| [0]    | None        |             |
| [1]    | Safe option |             |

## Parameter 42-11 Encoder Resolution

Table 1373: Parameter 42-11 Encoder Resolution

| 42-11 Encoder Resolution |  |                                |
|--------------------------|--|--------------------------------|
| Default value: [1024]    | Parameter type: Range, 1 - config. dependent | Setup: 1 setup                 |
| Conversion index: 0      | Data type: Uint16                            | Change during operation: False |

Encoder or proximity switch resolution of the encoder connected to the MCB 150 TTL and MCB 151 HTL.

## Parameter 42-12 Encoder Direction

Table 1374: Parameter 42-12 Encoder Direction

| 42-12 Encoder Direction      |                        |                                |
|------------------------------|------------------------|--------------------------------|
| Default value: [0] Clockwise | Parameter type: Option | Setup: 1 setup                 |
| Conversion index: -          | Data type: Uint8       | Change during operation: False |

| Option | Name             | Description |
|--------|------------------|-------------|
| [0]*   | Clockwise        |             |
| [1]    | Counterclockwise |             |

## Parameter 42-13 Gear Ratio

Table 1375: Parameter 42-13 Gear Ratio

| 42-13 Gear Ratio    |   |                                |
|---------------------|---|--------------------------------|
| Default value: 1    | Parameter type: Range, 0.0001 - 1000.0000 | Setup: 1 setup                 |
| Conversion index: 0 | Data type: Uint32                         | Change during operation: False |

Ratio between motor speed and encoder speed.

## NOTICE

Only use when the drive is gear-mounted.

## Parameter 42-14 Feedback Type

Table 1376: Parameter 42-14 Feedback Type

| 42-14 Feedback Type                    |                        |                                |
|--|------------------------|--------------------------------|
| Default value: [0] With direction info | Parameter type: Option | Setup: 1 setup                 |
| Conversion index: -                    | Data type: Uint8       | Change during operation: False |

| Option | Name                   | Description |
|--------|------------------------|-------------|
| [0]*   | With direction info    |             |
| [1]    | Without direction info |             |

## Parameter 42-15 Feedback Filter

Table 1377: Parameter 42-15 Feedback Filter

| 42-15 Feedback Filter |                                      |                                |
|-----------------------|--------------------------------------|--------------------------------|
| Default value: 200 Hz | Parameter type: Range, 0.01 - 200 Hz | Setup: 2 setups                |
| Conversion index: 0   | Data type: Uint16                    | Change during operation: False |

Frequency of the feedback filter. The default value is 200 Hz (off) if the encoder resolution is higher than 150 PPR. A filter value of 200 Hz is selected, meaning the filter is off. The use of filters depends on the given encoder resolution, gear ratio, and feedback type.

## Parameter 42-16 Mounting Type

Table 1378: Parameter 42-16 Mounting Type

| 42-16 Mounting Type                    |                        |                                |
|--|------------------------|--------------------------------|
| Default value: [0] Motor shaft mounted | Parameter type: Option | Setup: 2 setups                |
| Conversion index: -                    | Data type: Uint8       | Change during operation: False |

| Option | Name                | Description |
|--------|---------------------|-------------|
| [0]*   | Motor shaft mounted |             |
| [1]    | Application mounted |             |
| [2]    | Sensorless          |             |

## Parameter 42-18 Zero Speed Timer

Table 1379: Parameter 42-18 Zero Speed Timer

| 42-18 Zero Speed Timer |                                    |                                |
|------------------------|------------------------------------|--------------------------------|
| Default value: 8760 h  | Parameter type: Range, 0 - 10000 h | Setup: 1 setup                 |
| Conversion index: 74   | Data type: Uint16                  | Change during operation: False |

Time period where the option is allowed to be below 120 RPM when SLS is active before STO is activated.

## 5.31.3 42-2\* Safe Input

## Parameter 42-20 Safe Function

Table 1380: Parameter 42-20 Safe Function

| 42-20 Safe Function         |                        |                                |
|-----------------------------|------------------------|--------------------------------|
| Default value: Size related | Parameter type: Option | Setup: All setups              |
| Conversion index: -         | Data type: Uint8       | Change during operation: False |

Enable any of the safety options or disable safety option for the digital safe inputs.

| Option | Name  | Description |
|--------|-------|-------------|
| [0]    | STO   |             |
| [1]    | SS1-a |             |
| [2]    | SS1-b |             |
| [3]    | SLS-a |             |

| Option | Name              | Description |
|--------|-------------------|-------------|
| [4]    | SLS-b             |             |
| [5]    | Disable           |             |
| [8]    | SO mon            |             |
| [10]   | None              |             |
| [20]   | Internal event OK |             |
| [30]   | No function       |             |

## Parameter 42-21 Type

Table 1381: Parameter 42-21 Type

| 42-21 Type              |                        |                                |
|-------------------------|------------------------|--------------------------------|
| Default Value: [0] NCNC | Parameter Type: Option | Setup: All setups              |
| Conversion Index: -     | Data Type: Uint8       | Change during operation: False |

| Option | Name       | Description |
|--------|------------|-------------|
| [0]*   | NCNC       |             |
| [1]    | Antivalent |             |
| [2]    | NC         |             |
| [3]    | NO         |             |

## Parameter 42-22 Discrepancy Time

Table 1382: Parameter 42-22 Discrepancy Time

| 42-22 Discrepancy Time |                                    |                                |
|------------------------|------------------------------------|--------------------------------|
| Default Value: 10 ms   | Parameter Type: Range, 0 - 5000 ms | Setup: All setups              |
| Conversion Index: -3   | Data Type: Uint16                  | Change during operation: False |

An adjustable filter time prevents faults caused by temporary discrepancy.

## Parameter 42-23 Stable Signal Time

Table 1383: Parameter 42-23 Stable Signal Time

| 42-23 Stable Signal Time |                                    |                                |
|--------------------------|------------------------------------|--------------------------------|
| Default Value: 10 ms     | Parameter Type: Range, 0 - 5000 ms | Setup: All setups              |
| Conversion Index: -3     | Data Type: Uint16                  | Change during operation: False |

An adjustable signal filter in the safety option suppresses temporary signal changes using test pulse pattern.

## Parameter 42-24 Restart Behaviour

Table 1384: Parameter 42-24 Restart Behaviour

| 42-24 Restart Behaviour   |                        |                                |
|---------------------------|------------------------|--------------------------------|
| Default value: [0] Manual | Parameter type: Option | Setup: All setups              |
| Conversion index: -       | Data type: Uint8       | Change during operation: False |

| Option | Name      | Description |
|--------|-----------|-------------|
| [0]*   | Manual    |             |
| [1]    | Automatic |             |

### 5.31.4 42-3\* General

#### Parameter 42-30 External Failure Reaction

Table 1385: Parameter 42-30 External Failure Reaction

| 42-30 External Failure Reaction |                        |                                |
|---------------------------------|------------------------|--------------------------------|
| Default value: [0] STO          | Parameter type: Option | Setup: 1 setup                 |
| Conversion index: -             | Data type: Uint8       | Change during operation: False |

| Option | Name  | Description |
|--------|-------|-------------|
| [0]*   | STO   |             |
| [1]    | SS1-a |             |
| [2]    | SS1-b |             |

#### Parameter 42-31 Reset Source

Table 1386: Parameter 42-31 Reset Source

| 42-31 Reset Source             |                        |                                |
|--------------------------------|------------------------|--------------------------------|
| Default value: [0] Drive reset | Parameter type: Option | Setup: 1 setup                 |
| Conversion index: -            | Data type: Uint8       | Change during operation: False |

| Option | Name              | Description |
|--------|-------------------|-------------|
| [0]*   | Drive reset       |             |
| [1]    | Drive safe reset  |             |
| [2]    | Safe option DI2_A |             |

#### Parameter 42-33 Parameter Set Name

Table 1387: Parameter 42-33 Parameter Set Name

| 42-33 Parameter Set Name    |                              |                                |
|-----------------------------|------------------------------|--------------------------------|
| Default value: Size related | Parameter type: Range, 0 - 8 | Setup: 1 setup                 |
| Conversion index: 0         | Data type: VisibleString     | Change during operation: False |

Name of the safe parameter set. It is recommended to enter text with characters to avoid bad customization data error.



## 5.31.5 42-4\* SS1

## Parameter 42-40 Type

Table 1388: Parameter 42-40 Type

| 42-40 Type               |                        |                                |
|--------------------------|------------------------|--------------------------------|
| Default value: [0] Delay | Parameter type: Option | Setup: All setups              |
| Conversion index: -      | Data type: Uint8       | Change during operation: False |

Use this parameter to select the type of SS1 safety function.

| Option | Name         | Description |
|--------|--------------|-------------|
| [0]*   | Delay        |             |
| [1]    | Ramp (slope) |             |
| [2]    | Ramp (time)  |             |

## Parameter 42-41 Ramp Profile

Table 1389: Parameter 42-41 Ramp Profile

| 42-41 Ramp Profile        |                        |                                |
|---------------------------|------------------------|--------------------------------|
| Default value: [0] Linear | Parameter type: Option | Setup: All setups              |
| Conversion index: -       | Data type: Uint8       | Change during operation: False |

| Option | Name              | Description |
|--------|-------------------|-------------|
| [0]*   | Linear            |             |
| [2]    | S-ramp const time |             |

## Parameter 42-42 Delay Time

Table 1390: Parameter 42-42 Delay Time

| 42-42 Delay Time    |                                     |                                |
|---------------------|-------------------------------------|--------------------------------|
| Default value: 1 s  | Parameter type: Range, 0.1 - 3600 s | Setup: All setups              |
| Conversion index: 0 | Data type: Uint16                   | Change during operation: False |

Configure the time during which STO must be activated.

## Parameter 42-43 Delta T

Table 1391: Parameter 42-43 Delta T

| 42-43 Delta T       |                                |                                |
|---------------------|--------------------------------|--------------------------------|
| Default value: 2%   | Parameter type: Range, 0 - 99% | Setup: All setups              |
| Conversion index: 0 | Data type: Uint8               | Change during operation: False |

T subtracts from the time in *parameter 42-42 Delay Time* to get the motor to stop before the timer expires.

## Parameter 42-44 Deceleration Rate

Table 1392: Parameter 42-44 Deceleration Rate

| 42-44 Deceleration Rate |                                    |                                |
|-------------------------|------------------------------------|--------------------------------|
| Default value: 1500/s   | Parameter type: Range, 1 - 30000/s | Setup: All setups              |
| Conversion index: 0     | Data type: Uint16                  | Change during operation: False |

Deceleration rate for the SS1 slope-based ramp type.

## Parameter 42-45 Delta V

Table 1393: Parameter 42-45 Delta V

| 42-45 Delta V          |                                      |                                |
|------------------------|--------------------------------------|--------------------------------|
| Default value: 120 RPM | Parameter type: Range, 1 - 10000 RPM | Setup: All setups              |
| Conversion index: 67   | Data type: Uint16                    | Change during operation: False |

Tolerance between calculated and actual speed that the safety option allows.

## Parameter 42-46 Zero Speed

Table 1394: Parameter 42-46 Zero Speed

| 42-46 Zero Speed      |                                    |                                |
|-----------------------|------------------------------------|--------------------------------|
| Default value: 10 RPM | Parameter type: Range, 1 - 600 RPM | Setup: All setups              |
| Conversion index: 67  | Data type: Uint16                  | Change during operation: False |

When this speed is reached, the safety option activates the STO.

## Parameter 42-47 Ramp Time

Table 1395: Parameter 42-47 Ramp Time

| 42-47 Ramp Time     |                                     |                                |
|---------------------|-------------------------------------|--------------------------------|
| Default value: 1 s  | Parameter type: Range, 0.1 - 3600 s | Setup: All setups              |
| Conversion index: 0 | Data type: Uint16                   | Change during operation: False |

The time it takes to ramp down to 0 RPM.

## Parameter 42-48 S-ramp Ratio at Decel. Start

Table 1396: Parameter 42-48 S-ramp Ratio at Decel. Start

| 42-48 S-ramp Ratio at Decel. Start |                                |                                |
|------------------------------------|--------------------------------|--------------------------------|
| Default value: 50%                 | Parameter type: Range, 1 - 99% | Setup: All setups              |
| Conversion index: 0                | Data type: Uint8               | Change during operation: False |

The proportion of the total ramp-down time (*parameter 42-42 Delay Time*) where the deceleration torque increases. The larger the percentage value, the greater the jerk compensation achieved, and thus the lower the torque jerks in the application.

## Parameter 42-49 S-ramp Ratio at Decel. End

Table 1397: Parameter 42-49 S-ramp Ratio at Decel. End

| 42-49 S-ramp Ratio at Decel. End |                                |                                |
|----------------------------------|--------------------------------|--------------------------------|
| Default value: 50%               | Parameter type: Range, 1 - 99% | Setup: All setups              |
| Conversion index: 0              | Data type: Uint8               | Change during operation: False |

The proportion of the total ramp-down time (*parameter 42-42 Delay Time*) where the deceleration torque decreases. The larger the percentage value, the greater the jerk compensation achieved, and thus the lower the torque jerks in the application.

### 5.31.6 42-5\* SLS

#### Parameter 42-50 Cut Off Speed

Table 1398: Parameter 42-50 Cut Off Speed

| 42-50 Cut Off Speed    |  |                                |
|------------------------|--|--------------------------------|
| Default value: 270 RPM | Parameter type: Range, 120 - 10000 RPM | Setup: All setups              |
| Conversion index: 67   | Data type: Uint16                      | Change during operation: False |

Speed at which the fail-safe reaction gets activated. This should be the value of *parameter 42-51 Speed Limits* plus a tolerance.  
Parameter 42-51 Speed Limit

Table 1399: Parameter 42-51 Speed Limit

| 42-51 Speed Limit      |                                     |                                |
|------------------------|-------------------------------------|--------------------------------|
| Default value: 150 RPM | Parameter type: Range, 0 - 9999 RPM | Setup: All setups              |
| Conversion index: 67   | Data type: Uint16                   | Change during operation: False |

Maximum speed allowed when the SLS function is active.

#### Parameter 42-52 Fail Safe Reaction

Table 1400: Parameter 42-52 Fail Safe Reaction

| 42-52 Fail Safe Reaction |                        |                                |
|--------------------------|------------------------|--------------------------------|
| Default value: [0] STO   | Parameter type: Option | Setup: All setups              |
| Conversion index: -      | Data type: Uint8       | Change during operation: False |

| Option | Name  | Description |
|--------|-------|-------------|
| [0]*   | STO   |             |
| [1]    | SS1-a |             |
| [2]    | SS1-b |             |

#### Parameter 42-53 Start Ramp

Table 1401: Parameter 42-53 Start Ramp

| 42-53 Start Ramp      |                        |                                |
|-----------------------|------------------------|--------------------------------|
| Default value: [0] No | Parameter type: Option | Setup: All setups              |
| Conversion index: -   | Data type: Uint8       | Change during operation: False |

| Option | Name | Description |
|--------|------|-------------|
| [0]*   | No   |             |
| [1]    | Yes  |             |

## Parameter 42-54 Ramp Down Time

Table 1402: Parameter 42-54 Ramp Down Time

| 42-54 Ramp Down Time |                                     |                                |
|----------------------|-------------------------------------|--------------------------------|
| Default value: 1 s   | Parameter type: Range, 0.1 - 3600 s | Setup: All setups              |
| Conversion index: 0  | Data type: Uint16                   | Change during operation: False |

Ramp-down time for the start ramp.

## 5.31.7 42-7\* SMS

## Parameter 42-70 Activation

Table 1403: Parameter 42-70 Activation

| 42-70 Activation            |                        |                                |
|-----------------------------|------------------------|--------------------------------|
| Default value: [0] Inactive | Parameter type: Option | Setup: 2 setups                |
| Conversion index: -         | Data type: Uint8       | Change during operation: False |

| Option | Name     | Description |
|--------|----------|-------------|
| [0]*   | Inactive |             |
| [1]    | Active   |             |

## Parameter 42-71 Cut Off Speed

Table 1404: Parameter 42-71 Cut Off Speed

| 42-71 Cut Off Speed     |  |                                |
|-------------------------|--|--------------------------------|
| Default value: 1500 RPM | Parameter type: Range, 120 - 20000 RPM | Setup: 2 setups                |
| Conversion index: 67    | Data type: Uint16                      | Change during operation: False |

Maximum allowed speed.

## 5.31.8 42-8\* Status

## Parameter 42-80 Safe Option Status

Table 1405: Parameter 42-80 Safe Option Status

| 42-80 Safe Option Status |                                       |                               |
|--------------------------|---------------------------------------|-------------------------------|
| Default value: 0         | Parameter type: Range, 0 - 4294967295 | Setup: All setups             |
| Conversion index: 0      | Data type: Uint32                     | Change during operation: True |

Shows the safety option status word as a hexadecimal value.

## Parameter 42-81 Safe Option Status 2

Table 1406: Parameter 42-81 Safe Option Status 2

| 42-81 Safe Option Status 2 |                                       |                               |
|----------------------------|---------------------------------------|-------------------------------|
| Default value: 0           | Parameter type: Range, 0 - 2147483647 | Setup: 1 setup                |
| Conversion index: 0        | Data type: Uint32                     | Change during operation: True |

Shows the safety option status word 2 as a hexadecimal value. For example, it contains DI1, DI2, and blank initial state status.

## Parameter 42-85 Active Safe Func.

Table 1407: Parameter 42-85 Active Safe Func.

| 42-85 Active Safe Func.  |                        |                               |
|--------------------------|------------------------|-------------------------------|
| Default value: [10] None | Parameter type: Option | Setup: All setups             |
| Conversion index: -      | Data type: Uint8       | Change during operation: True |

| Option | Name   | Description |
|--------|--------|-------------|
| [0]    | STO    |             |
| [1]    | SS1-a  |             |
| [2]    | SS1-b  |             |
| [3]    | SLS-a  |             |
| [4]    | SLS-b  |             |
| [8]    | SO Mon |             |
| [10]*  | None   |             |

## Parameter 42-86 Safe Option Info

Table 1408: Parameter 42-86 Safe Option Info

| 42-86 Safe Option Info |                               |                               |
|------------------------|-------------------------------|-------------------------------|
| Default value: 0       | Parameter type: Range, 0 - 25 | Setup: All setups             |
| Conversion index: 0    | Data type: VisibleString      | Change during operation: True |

Shows information about the safety option. Can be used on the LCP.

## Parameter 42-89 Customization File Version

Table 1409: Parameter 42-89 Customization File Version

| 42-89 Customization File Version |                                     |                               |
|----------------------------------|-------------------------------------|-------------------------------|
| Default value: Size related      | Parameter type: Range, 0.00 - 99.99 | Setup: 1 setup                |
| Conversion index: 0              | Data type: Uint16                   | Change during operation: True |

Stores the customization file version.

## 5.32 Parameter Group 43-\*\* Unit Readouts

The parameters in this group provide readouts for monitoring the operation of drives in enclosure sizes D–F.

## 5.32.1 43-0\* Component Status

## N O T I C E

The following parameters are only available in FC 302:

- *Parameter 43-00 Component Temp.*
- *Parameter 43-01 Auxiliary Temp.*

This parameter group contains read-only information on hardware components in the power section. All parameters in this group are arrays:

- [0]: Power card 1 (the master power card in a parallel drive, or the only power card in a drive with a single inverter section).
- [1]: Power card 2 (inverter connection in a parallel drive).
- [2]: Power card 3 (inverter connection in a parallel drive).
- [3]: Power card 4 (inverter connection in a parallel drive).
- [4]: Power card 5 (rectifier connection in a parallel drive).
- [5]: Power card 6 (rectifier connection in a parallel drive).
- [6]: Power card 7 (rectifier connection in a parallel drive).
- [7]: Power card 8 (rectifier connection in a parallel drive).
- [8]: Inrush card (optional).
- [9]: Fan power card 1 (optional).
- [10]: Fan power card 2 (optional).

Parameter 43-00 Component Temp.

Table 1410: Parameter 43-00 Component Temp.

| 43-00 Component Temp. |  |                               |
|-----------------------|--|-------------------------------|
| Default value: 0 °C   | Parameter type: Range, -128 - 127 °C, Array [18] | Setup: All set-ups            |
| Conversion index: 100 | Data type: Int8                                  | Change during operation: True |

Shows the temperature of a system component. The elements of the array reference local PCB temperature sensor measurements. *Parameter 16-31 System Temp.* uses all elements in this array to calculate the system temperature.

Parameter 43-01 Auxiliary Temp.

Table 1411: Parameter 43-01 Auxiliary Temp.

| 43-01 Auxiliary Temp. |  |                               |
|-----------------------|--|-------------------------------|
| Default value: 0 °C   | Parameter type: Range, -128 - 127 °C, Array [18] | Setup: All set-ups            |
| Conversion index: 100 | Data type: Int8                                  | Change during operation: True |

Shows the temperature of an auxiliary component. The elements of the array reference the temperature measurements from the NTC temperature sensors connected to hardware components in the drive. Refer to the Operating Guide for specifications of temperature sensor placement.

Parameter 43-02 Component SW ID

Table 1412: Parameter 43-02 Component SW ID

| 43-02 Component SW ID |   |                               |
|-----------------------|---|-------------------------------|
| Default value: 0      | Parameter type: Range, 0 - 20, Array [18] | Setup: All set-ups            |
| Conversion index: 0   | Data type: VisStr[18]                     | Change during operation: True |

Shows the software version of the installed option.

### 5.32.2 43-1\* Power Card Status

## N O T I C E

This parameter group is only available in FC 302.

This parameter group contains read-only information on the power card status. All parameters in this group are arrays:

- [0]: Power card 1 (the master power card in a parallel drive, or the only power card in a drive with a single inverter section).
- [1]: Power card 2 (inverter connection in a parallel drive).

- [2]: Power card 3 (inverter connection in a parallel drive).
- [3]: Power card 4 (inverter connection in a parallel drive).
- [4]: Power card 5 (rectifier connection in a parallel drive).
- [5]: Power card 6 (rectifier connection in a parallel drive).
- [6]: Power card 7 (rectifier connection in a parallel drive).
- [7]: Power card 8 (rectifier connection in a parallel drive).

## Parameter 43-10 HS Temp. ph.U

Table 1413: Parameter 43-10 HS Temp. ph.U

| 43-10 HS Temp. ph.U   |  |                               |
|-----------------------|--|-------------------------------|
| Default value: 0 °C   | Parameter type: Range, -128 - 127, Array [8] | Setup: All set-ups            |
| Conversion index: 100 | Data type: Int8                              | Change during operation: True |

Shows the heat sink temperature at the location of the phase U IGBT power module. This measurement is not available in all enclosure sizes. *Parameter 16-34 Heatsink Temp.* uses the value in this parameter.

## Parameter 43-11 HS Temp. ph.V

Table 1414: Parameter 43-11 HS Temp. ph.V

| 43-11 HS Temp. ph.V   |  |                               |
|-----------------------|--|-------------------------------|
| Default value: 0 °C   | Parameter type: Range, -128 - 127, Array [8] | Setup: All set-ups            |
| Conversion index: 100 | Data type: Int8                              | Change during operation: True |

Shows the heat sink temperature at the location of the phase V IGBT power module. This measurement is not available in all enclosure sizes. *Parameter 16-34 Heatsink Temp.* uses the value in this parameter.

## Parameter 43-12 HS Temp. ph.W

Table 1415: Parameter 43-12 HS Temp. ph.W

| 43-12 HS Temp. ph.W   |  |                               |
|-----------------------|--|-------------------------------|
| Default value: 0 °C   | Parameter type: Range, -128 - 127, Array [8] | Setup: All set-ups            |
| Conversion index: 100 | Data type: Int8                              | Change during operation: True |

Shows the heat sink temperature at the location of the phase W IGBT power module. This measurement is not available in all enclosure sizes. *Parameter 16-34 Heatsink Temp.* uses the value in this parameter.

## Parameter 43-13 PC Fan A Speed

Table 1416: Parameter 43-13 PC Fan A Speed

| 43-13 PC Fan A Speed |   |                               |
|----------------------|---|-------------------------------|
| Default value: 0 RPM | Parameter type: Range, 0 - 65535, Array [8] | Setup: All set-ups            |
| Conversion index: 67 | Data type: Uint16                           | Change during operation: True |

Shows the measured speed of fan A on the power card. Each power card has up to 3 fan connections. Place the fan in the drive according to the Operating Guide. A typical placement for fan A is in the backchannel (the external fan). The value of this parameter is:

- The actual fan speed when there is a DC fan in the drive.
- Relative speed when there is an AC fan in the drive.

## Parameter 43-14 PC Fan B Speed

Table 1417: Parameter 43-14 PC Fan B Speed

| 43-14 PC Fan B Speed |   |                               |
|----------------------|---|-------------------------------|
| Default value: 0 RPM | Parameter type: Range, 0 - 65535, Array [8] | Setup: All set-ups            |
| Conversion index: 67 | Data type: Uint16                           | Change during operation: True |

Shows the measured speed of fan B on the power card. Each power card has up to 3 fan connections. Place the fan in the drive according to the Operating Guide. A typical placement for fan B is on the enclosure door (the internal fan). The value of this parameter is:

- The actual fan speed when there is a DC fan in the drive.
- Relative speed when there is an AC fan in the drive.

## Parameter 43-15 PC Fan C Speed

Table 1418: Parameter 43-15 PC Fan C Speed

| 43-15 PC Fan C Speed |   |                               |
|----------------------|---|-------------------------------|
| Default value: 0 RPM | Parameter type: Range, 0 - 65535, Array [8] | Setup: All set-ups            |
| Conversion index: 67 | Data type: Uint16                           | Change during operation: True |

Shows the measured speed of fan C on the power card. Each power card has up to 3 fan connections. Place the fan in the drive according to the Operating Guide. A typical placement for fan C is inside the enclosure (the mixing fan). The value of this parameter is:

- The actual fan speed when there is a DC fan in the drive.
- Relative speed when there is an AC fan in the drive.

## 5.32.3 43-2\* Fan Pow.Card Status

## N O T I C E

This parameter group is only available in FC 302.

## Parameter 43-20 FPC Fan A Speed

Table 1419: Parameter 43-20 FPC Fan A Speed

| 43-20 FPC Fan A Speed |   |                               |
|-----------------------|---|-------------------------------|
| Default value: 0 RPM  | Parameter type: Range, 0 - 65535, Array [2] | Setup: All set-ups            |
| Conversion index: 67  | Data type: Uint16                           | Change during operation: True |

Shows the speed of the power card fan A.

## Parameter 43-21 FPC Fan B Speed

Table 1420: Parameter 43-21 FPC Fan B Speed

| 43-21 FPC Fan B Speed |   |                               |
|-----------------------|---|-------------------------------|
| Default value: 0 RPM  | Parameter type: Range, 0 - 65535, Array [2] | Setup: All set-ups            |
| Conversion index: 67  | Data type: Uint16                           | Change during operation: True |

Shows the speed of the power card fan B.



Parameter 43-23 FPC Fan D Speed

Table 1421: Parameter 43-23 FPC Fan D Speed

| 43-23 FPC Fan D Speed |   |                               |
|-----------------------|---|-------------------------------|
| Default value: 0 RPM  | Parameter type: Range, 0 - 65535, Array [2] | Setup: All set-ups            |
| Conversion index: 67  | Data type: Uint16                           | Change during operation: True |

Shows the speed of the power card fan D.

Parameter 43-24 FPC Fan E Speed

Table 1422: Parameter 43-24 FPC Fan E Speed

| 43-24 FPC Fan E Speed |   |                               |
|-----------------------|---|-------------------------------|
| Default value: 0 RPM  | Parameter type: Range, 0 - 65535, Array [2] | Setup: All set-ups            |
| Conversion index: 67  | Data type: Uint16                           | Change during operation: True |

Shows the speed of the power card fan E.

Parameter 43-25 FPC Fan F Speed

Table 1423: Parameter 43-25 FPC Fan F Speed

| 43-25 FPC Fan F Speed |   |                               |
|-----------------------|---|-------------------------------|
| Default value: 0 RPM  | Parameter type: Range, 0 - 65535, Array [2] | Setup: All set-ups            |
| Conversion index: 67  | Data type: Uint16                           | Change during operation: True |

Shows the speed of the power card fan F.

### 5.33 Parameter Group 50-\*\* License

Parameter 50-00 License Installed

Table 1424: Parameter 50-00 License Installed

| 50-00 License Installed |  |                                |
|-------------------------|--|--------------------------------|
| Default value: 0        | Parameter type: Range, 0 - 40, Array [3] | Setup: All setups              |
| Conversion index: 0     | Data type: VisibleString                 | Change during operation: False |

Shows all licenses activated in the drive.

Parameter 50-01 License Code

Table 1425: Parameter 50-01 License Code

| 50-01 License Code          |                               |                               |
|-----------------------------|-------------------------------|-------------------------------|
| Default value: Size related | Parameter type: Range, 0 - 19 | Setup: 1 setup                |
| Conversion index: 0         | Data type: VisibleString      | Change during operation: True |

Enter the license code provided by the Danfoss sales representative to activate licensed features in the drive. The license code comprises 16 alphanumeric characters in the format (XXXX-XXXX-XXXX-XXXX). When the license is accepted by the drive, the parameter is shown as 0000-0000-0000-0000.

## NOTICE

Restart the drive after entering the new license code. Parameters relevant for configuring the new feature(s) are now shown in the drive. The new type code is reflected in *parameter 15-45 Actual Typecode String*. The original type code of the drive can be viewed in *parameter 15-44 Ordered Typecode String*. The activated license is shown in *parameter 50-00 License Installed*.

The license code can also be set from the factory.

### 5.34 Parameter Group 600-\*\* PROFIsafe

Parameter 600-22 PROFIdrive/safe Tel. Selected

Table 1426: Parameter 600-22 PROFIdrive/safe Tel. Selected

| 600-22 PROFIdrive/safe Tel. Selected |                                  |                               |
|--------------------------------------|----------------------------------|-------------------------------|
| Default value: 0                     | Parameter type: Range, 0 - 65535 | Setup: All setups             |
| Conversion index: 0                  | Data type: Uint16                | Change during operation: True |

Parameter 600-44 Fault Message Counter

Table 1427: Parameter 600-44 Fault Message Counter

| 600-44 Fault Message Counter |                                  |                               |
|------------------------------|----------------------------------|-------------------------------|
| Default value: 0             | Parameter type: Range, 0 - 65535 | Setup: 1 setup                |
| Conversion index: 0          | Data type: Uint16                | Change during operation: True |

Shows the number of safety fault buffer changes.

Parameter 600-47 Fault Number

Table 1428: Parameter 600-47 Fault Number

| 600-47 Fault Number |                                  |                               |
|---------------------|----------------------------------|-------------------------------|
| Default value: 0    | Parameter type: Range, 0 - 65535 | Setup: 1 setup                |
| Conversion index: 0 | Data type: Uint16                | Change during operation: True |

Shows the internal fault number for a fault in the safety fault buffer.

Parameter 600-52 Fault Situation Counter

Table 1429: Parameter 600-52 Fault Situation Counter

| 600-52 Fault Situation Counter |                                  |                               |
|--------------------------------|----------------------------------|-------------------------------|
| Default value: 0               | Parameter type: Range, 0 - 65535 | Setup: 1 setup                |
| Conversion index: 0            | Data type: Uint16                | Change during operation: True |

Number of fault situations that have occurred since the last reset in the safety fault buffer.

### 5.35 Parameter Group 601-\*\* PROFIdrive 2

Parameter 601-22 PROFIdrive Safety Channel Tel. No.

Table 1430: Parameter 601-22 PROFIdrive Safety Channel Tel. No.

| 601-22 PROFIdrive Safety Channel Tel. No. |                                  |                               |
|---|----------------------------------|-------------------------------|
| Default value: 108                        | Parameter type: Range, 0 - 65535 | Setup: All setups             |
| Conversion index: 0                       | Data type: Uint16                | Change during operation: True |

## 6 Integrated Motion Controller

### 6.1 Introduction

#### NOTICE

The integrated motion control is only available with special IMC software version 48.XX. To order the drive with the IMC software, use the type code with software release version S067.

The integrated motion controller (IMC) enables position control with all motor control principles and motor types with and without feedback.

To activate the IMC functionality, select [9] *Positioning* or [10] *Synchronization* in *parameter 1-00 Configuration Mode*. IMC enables the following functions:

- Positioning: Absolute, relative, and touch probe.
- Homing.
- Position synchronization.
- Virtual master.

Position control in both positioning and synchronization modes can be either sensorless or with feedback. In the sensorless control principle, the motor angle calculated by the motor controller is used as feedback. In the closed-loop control principle, VLT® AutomationDrive FC 301 supports 24 V encoders as standard. With extra options, the drive supports most standard incremental encoders, absolute encoders, and resolvers. The position controller can handle both linear and rotary systems. The controller can scale positions to any relevant physical unit such as mm or degrees.

### 6.2 Positioning, Homing, and Synchronization

#### 6.2.1 Positioning

The drive supports relative positioning and absolute positioning. A positioning command requires 3 inputs:

- Target position.
- Speed reference.
- Ramp times.

The 3 inputs can come from various sources, see [Illustration 100](#).

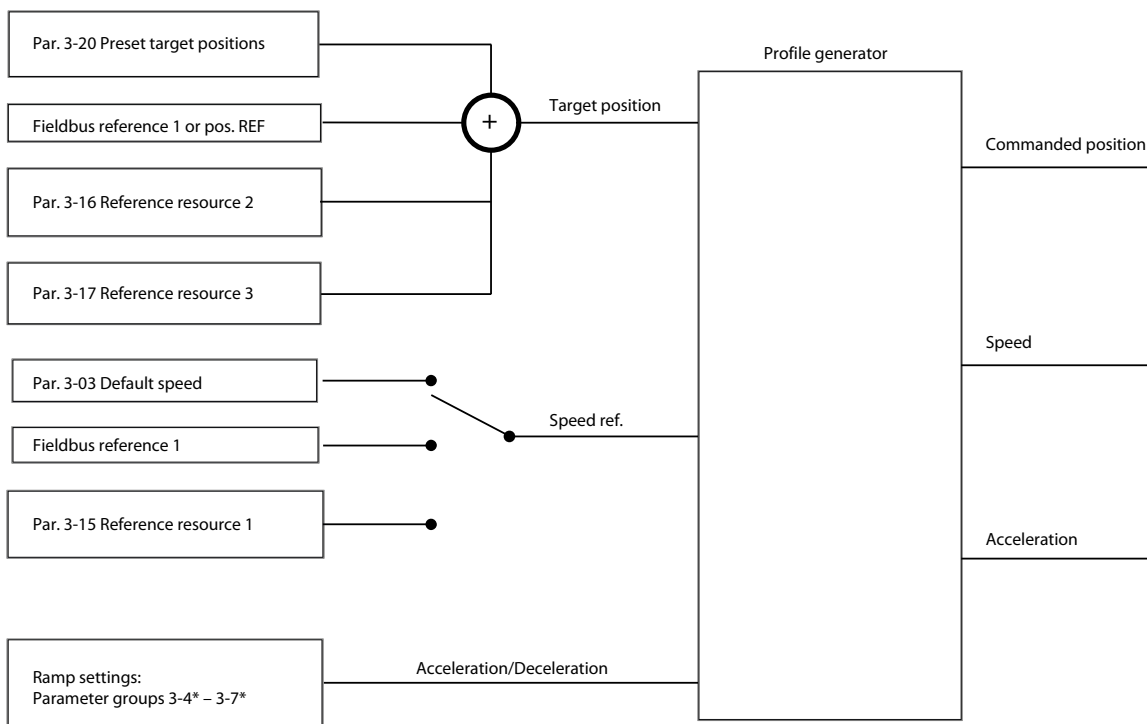

e30be774.11

**Illustration 100: Positioning References**

In each control cycle (1 ms), the profile generator calculates position, speed, and acceleration required to do the specified movement. The outputs from the profile generator are used for the position and speed controller.

### 6.2.2 Homing

Homing is required for creating a reference to the physical machine position in closed-loop control principle with incremental encoder or in sensorless control principle. IMC supports various homing functions with or without a homing sensor. Select the homing function in *parameter 17-80 Homing Function*. After selecting a homing function, complete homing before executing absolute positioning.

### 6.2.3 Synchronization

In synchronization mode, the drive follows the position of a master signal. The master signal and the offset between the master and the slave are handled as shown in [Illustration 101](#).

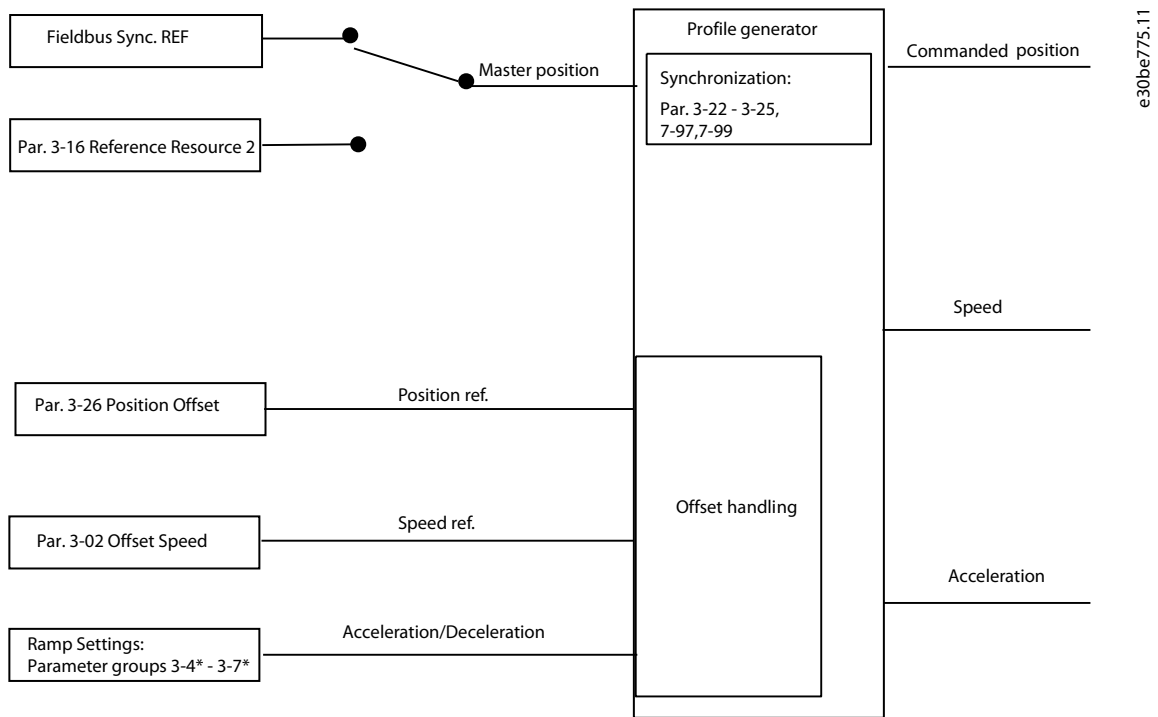

Illustration 101: Synchronization References

In each control cycle (1 ms), the profile generator calculates position, speed, and acceleration required to do the specified movement. The outputs from the profile generator are used as inputs for the position and speed controller.

### 6.2.4 Fieldbus References

Fieldbus references for speed and position are set via the process data (PCD) configuration as shown in the example:

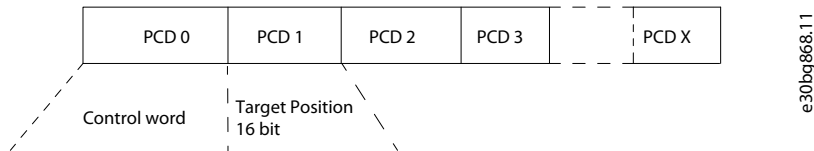

Illustration 102: Positioning: Default settings (PCD 1 = Fieldbus REF 1)

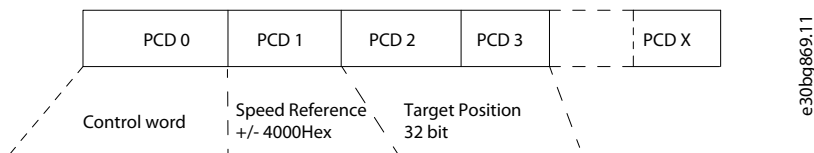

Illustration 103: Positioning: PCD write configuration PCD 1 = Fieldbus REF 1, PCD 2 and 3 = Fieldbus Pos REF

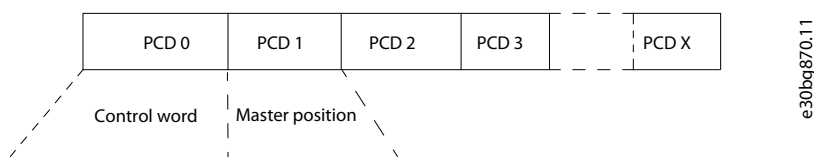

Illustration 104: Synchronizing: PCD write configuration PCD 1 = Fieldbus Sync REF

### 6.3 Control

#### 6.3.1 Control Loops

In positioning and synchronization mode, 2 extra control loops control the motor in addition to the motor controller running flux control principle, sensorless, or with motor feedback. The position PI controller is the outer loop providing the setpoint for the speed PID, which provides the reference for the motor controller. For a closed loop, feedback source can be selected individually for each of 3 controllers.

For sensorless control principle, select [0] Motor feedb. P1-02 in the following parameters:

- Speed PID: Parameter 7-00 Speed PID Feedback Source.
- Position PI: Parameter 7-90 Position PI Feedback Source.

With this set-up, both controllers use the motor angle calculated by the motor controller. See [Illustration 105](#) for control structure and parameters affecting the control behavior.

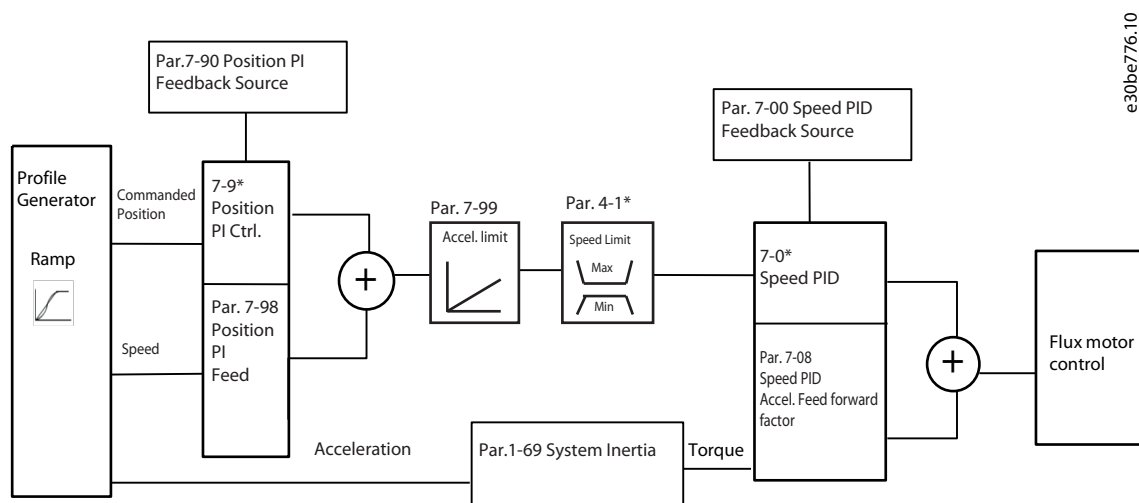

Illustration 105: Positioning and Synchronization Mode

#### 6.3.2 Control and Status Signals

IMC control and status signals are available I/O bits and fieldbus bits.

Table 1431: Control and Status Signals

| Name                   | Function   | Digital input <sup>(1)</sup> | Control word | Digital output | Status word |
|------------------------|--|------------------------------|--------------|----------------|-------------|
| <b>Control signals</b> |  |                              |              |                |             |
| Enable master offset   | Activates the master offset when <i>parameter 17-93 Master Offset Selection</i> is set to options [0]–[5]. | x                            | x            | –              | –           |
| Start homing           | Starts selected homing function.   | x                            | x            | –              | –           |
| Start virtual master   | Starts the virtual master.   | x                            | x            | –              | –           |
| Activate touch         | Selects touch probe positioning mode.  | x                            | x            | –              | –           |
| Relative position      | Selects between absolute and relative positioning.   | x                            | x            | –              | –           |
| Enable reference       | Starts selected motion.  | x                            | x            | –              | –           |
| Sync. to position mode | Selects positioning in synchronizing mode.   | x                            | x            | –              | –           |

| Name                         | Function   | Digital input <sup>(1)</sup> | Control word | Digital output | Status word |
|------------------------------|--|------------------------------|--------------|----------------|-------------|
| Home sensor                  | Selects input for home sensor.   | x                            | x            | –              | –           |
| Home sensor inverse          | Selects input for home sensor.   | x                            | –            | –              | –           |
| Touch sensor                 | Selects input for touch probe sensor.  | x                            | x            | –              | –           |
| Touch sensor inverse         | Selects input for touch probe sensor.  | x                            | –            | –              | –           |
| Speed mode                   | Selects speed mode when <i>parameter 1-00 Configuration Mode</i> is set to [9] <i>Positioning</i> or [10] <i>Synchronization</i> .             | x                            | x            | –              | –           |
| Target inverse               | Changes the sign of the set target position. For example, if the set target is 1000, the activation of this option changes the value to -1000. | x                            | x            | –              | –           |
| Position virtual master      | Activates position-controlled virtual master   | x                            | x            | –              | –           |
| Set master home              | Master position = <i>parameter 17-88 Master Home</i>   | x                            | x            | –              | –           |
| Set vir. mas. pos. to actual | Virtual master position = <i>parameter 16-06 Actual Position</i>   | x                            | x            | –              | –           |
| Activate CAM table           | Activation of new CAM table while running  | x                            | x            | –              | –           |
| Master marker                | Master marker signal for marker synchronization, rising edge   | x                            | –            | –              | –           |
| Master marker (inverse)      | Master marker signal for marker synchronization, falling edge  |                              |              |                |             |
| Follower marker              | Follower marker signal for marker synchronizing, rising edge   | x                            | –            | –              | –           |
| Follower marker (inverse)    | Follower marker signal for marker synchronizing, falling edge  | x                            | –            | –              | –           |
| <b>Status signals</b>        |  |                              |              |                |             |
| Reverse after ramp           | Indicates the sign of speed reference after the ramp.  | –                            | –            | x              | –           |
| Virtual master dir.          | Controls the direction of slaves.  | –                            | –            | x              | –           |
| Homing OK                    | Homing is completed with the selected homing function.   | –                            | –            | X              | X           |
| On target                    | Positioning: Target position reached.<br>Synchronization: Slave position aligned with master position.   | –                            | –            | x              | x           |
| Position error               | Maximum position error exceeded.   | –                            | –            | x              | x           |
| Position limit               | A position limit is reached ( <i>parameter 3-06 Minimum Position</i> or <i>parameter 3-07 Maximum Position</i> ).                              | –                            | –            | x              | –           |
| Touch on target              | Target position is reached in touch probe position mode.   | –                            | –            | x              | x           |
| Touch activated              | Touch probe positioning active.  | –                            | –            | x              | x           |
| Touch sensor found           | The touch sensor has been detected.  | –                            | –            | x              | x           |

| Name                        | Function  | Digital input <sup>(1)</sup> | Control word | Digital output | Status word |
|-----------------------------|---|------------------------------|--------------|----------------|-------------|
| Vir. master on ref.         | The virtual master is running on the set reference  | –                            | –            | x              | x           |
| Execution distance extended | The offset execution distance set in <i>parameter 17-95 Offset Execution Distance</i> has been extended due to speed/ramp limitation. | –                            | –            | –              | x           |
| Pos. set acknowledge        | The set target position has been activated.   | –                            | –            | x              | x           |

<sup>1</sup> For best accuracy, use fast digital inputs 18, 32, and 33 for home and touch probe sensors.

When [3] *FC Motion Profile* is selected in *parameter 8-10 Control Word Profile*, the bits in the control word and the status word have the following meaning:

**Table 1432: Control Word**

| Bit               | 0                    | 1                |
|-------------------|----------------------|------------------|
| 0                 | Preset reference LSB | –                |
| 1                 | Preset reference MSB | –                |
| 2 <sup>(1)</sup>  | Preset reference EXB | –                |
| 3                 | Coast stop           | No coast stop    |
| 4                 | Quick stop           | No quick stop    |
| 5 <sup>(1)</sup>  | No reference         | Enable reference |
| 6                 | Ramp stop            | Start            |
| 7                 | No reset             | Reset            |
| 8                 | No jog               | Jog              |
| 9 <sup>(1)</sup>  | Absolute             | Relative         |
| 10                | Data not valid       | Data valid       |
| 11 <sup>(1)</sup> | No homing            | Start homing     |
| 12 <sup>(1)</sup> | No touch             | Activate touch   |



| Bit | 0                 | 1         |
|-----|-------------------|-----------|
| 13  | Set-up select LSB | –         |
| 14  | Set-up select MSB | –         |
| 15  | No reversing      | Reversing |

<sup>1</sup> Different from [0] FC Profile. Options for bits 0–2, and 12–15 in *parameter 8-14 Configurable Control Word CTW*:

- [11] Start Homing
- [12] Activate Touch Probe
- [13] Sync. to Pos. Mode
- [14] Ramp 2
- [15] Relay 1
- [16] Relay 2
- [17] Speed Mode
- [18] Start Virtual Master
- [19] Activate Master Offset
- [21] Target Inverse
- [26] Home Sensor
- [27] Touch Sensor
- [28] Position Vir. Master
- [29] Set Master Home
- [30] Set Vir. Mas. Pos. to Actual
- [31] Activate CAM Table

**Table 1433: Status Word**

| Bit              | 0                      | 1                       |
|------------------|------------------------|-------------------------|
| 0                | Control not ready      | Control ready           |
| 1                | Drive not ready        | Drive ready             |
| 2                | Coasting               | Enable                  |
| 3                | No error               | Trip                    |
| 4 <sup>(1)</sup> | Not homed              | Home done               |
| 5                | Reserved               | Reserved                |
| 6                | No error               | Trip lock               |
| 7                | No warning             | Warning                 |
| 8 <sup>(1)</sup> | Not on target position | Target position reached |
| 9                | Local operation        | Bus control             |
| 10               | Out of frequency limit | Frequency limit OK      |
| 11               | No operation           | In operation            |
| 12               | Drive OK               | Stopped, auto start     |

| Bit | 0          | 1                |
|-----|------------|------------------|
| 13  | Voltage OK | Voltage exceeded |
| 14  | Torque OK  | Torque exceeded  |
| 15  | Timer OK   | Timer exceeded   |

<sup>1</sup> Different from [0] FC Profile. Options for bits 5 and 12–15 in parameter 8-13 Configurable Status Word STW:

- [4] Position Error
- [5] Position Limit
- [6] Touch on Target
- [7] Touch Activated
- [8] Touch Sen. Found
- [9] Vir. Master on Ref.
- [22] Execution Distance Extended
- [210] Pos. Set Acknowledge

## 7 Troubleshooting

### 7.1 Status Messages

#### 7.1.1 Warnings and Alarms

A warning or an alarm is signaled by the relevant indicator light on the front of the drive and indicated by a code on the display. A warning remains active until its cause is no longer present. Under certain circumstances, operation of the motor may still be continued. Warning messages may be critical, but are not necessarily so.

In the event of an alarm, the drive trips. Reset the alarm to resume operation once the cause has been rectified.

3 ways to reset:

- Press [Reset].
- Via a digital input with the reset function.
- Via serial communication/optional fieldbus.

### N O T I C E

After a manual reset pressing [Reset], press [Auto On] to restart the motor.

If an alarm cannot be reset, the reason may be that its cause has not been rectified, or the alarm is trip locked.

Alarms that are trip locked offer extra protection, meaning that the mains supply must be switched off before the alarm can be reset. After being switched back on, the drive is no longer blocked and can be reset once the cause has been rectified.

Alarms that are not trip locked can also be reset using the automatic reset function in *parameter 14-20 Reset Mode* (Warning: Automatic wake up is possible.)

If a warning or alarm is marked against a code in the alarm/warning code list, this means that either a warning occurs before an alarm, or it is possible to specify whether a warning or an alarm should be shown for a given fault.

This is possible, for instance, in *parameter 1-90 Motor Thermal Protection*. After an alarm or trip, the motor carries on coasting, and the alarm and warning flash. Once the problem has been rectified, only the alarm continues flashing until the drive is reset.

### N O T I C E

No missing motor phase detection (numbers 30-32) and no stall detection are active when *parameter 1-10 Motor Construction* is set to [1] PM non-salient SPM.

#### 7.1.2 Alarm/Warning Code List

Table 1434: Alarm/Warning Code List

| Number | Description          | Warning | Alarm/trip | Alarm/trip lock | Parameter reference   |
|--------|----------------------|---------|------------|-----------------|---|
| 1      | 10 volts low         | X       | –          | –               | <i>Parameter 14-90.0 Fault Level</i>  |
| 2      | Live zero error      | (X)     | (X)        | –               | <i>Parameter 6-01 Live Zero Timeout Function</i>  |
| 3      | No motor             | (X)     | –          | –               | <i>Parameter 1-80 Function at Stop and parameter 4-58 Missing Motor Phase when set to [5] Motor check</i> |
| 4      | Mains phase loss     | (X)     | (X)        | (X)             | <i>Parameter 14-12 Response to Mains Imbalance</i>  |
| 5      | DC-link voltage high | X       | –          | –               | –   |
| 6      | DC-link voltage low  | X       | –          | –               | –   |
| 7      | DC overvoltage       | X       | X          | –               | –   |
| 8      | DC undervoltage      | X       | X          | –               | –   |

| Number | Description                      | Warning | Alarm/trip | Alarm/trip lock | Parameter reference   |
|--------|----------------------------------|---------|------------|-----------------|---|
| 9      | Inverter overloaded              |         | X          | X               | –   |
| 10     | Motor ETR overtemperature        | (X)     | (X)        | –               | <i>Parameter 1-90 Motor Thermal Protection</i>  |
| 11     | Motor thermistor overtemperature | (X)     | (X)        | –               | <i>Parameter 1-90 Motor Thermal Protection</i>  |
| 12     | Torque limit                     | X       | X          | –               | <i>Parameter 14-90.6 Fault level and parameter 14-25 Trip Delay at Torque Limit</i>   |
| 13     | Over current                     | X       | X          | X               | –   |
| 14     | Ground fault                     | –       | X          | X               | <i>Parameter 14-90.4 Fault Level</i>  |
| 15     | Hardware mismatch                | –       | X          | X               | –   |
| 16     | Short circuit                    | –       | X          | X               | <i>Parameter 14-90.8 Fault Level default is Trip Lock</i>                             |
| 17     | Control word timeout             | (X)     | (X)        | –               | <i>Parameter 8-04 Control Word Timeout Function</i>                                   |
| 20     | Temp. input error                | –       | X          | –               | –   |
| 21     | Param error                      | –       | –          | X               | –   |
| 22     | Hoist mech. brake                | (X)     | (X)        | –               | <i>Parameter group 2-2* Mechanical Brake</i>  |
| 23     | Internal fans                    | X       | –          | –               | –   |
| 24     | External fans                    | X       | –          | –               | –   |
| 25     | Brake resistor short-circuited   | X       | –          | –               | –   |
| 26     | Brake resistor power limit       | (X)     | (X)        | –               | <i>Parameter 2-13 Brake Power Monitoring</i>  |
| 27     | Brake chopper short-circuited    | X       | X          | –               | –   |
| 28     | Brake check                      | (x)     | (X)        | –               | <i>Parameter 2-15 Brake Check</i>   |
| 29     | Heat sink temp                   | –       | X          | X               | <i>Parameter 14-90.9 Fault Level</i>  |
| 30     | Motor phase U missing            | –       | (X)        | (X)             | <i>Parameter 4-58 Missing Motor Phase Function and parameter 14-90.16 Fault Level</i> |
| 31     | Motor phase V missing            | –       | (X)        | (X)             | <i>Parameter 4-58 Missing Motor Phase Function and parameter 14-90.16 Fault Level</i> |
| 32     | Motor phase W missing            | –       | (X)        | (X)             | <i>Parameter 4-58 Missing Motor Phase Function and parameter 14-90.16 Fault Level</i> |
| 33     | Inrush fault                     | –       | X          | X               | –   |
| 34     | Fieldbus communication fault     | X       | –          | –               | <i>Parameter 14-90.27 Fault Level</i>   |
| 35     | Option fault                     | –       | –          | X               | –   |
| 36     | Mains failure                    | X       | X          | –               | –   |
| 37     | Imbalance of supply voltage      | –       | X          | –               | –   |

| Number | Description                            | Warning | Alarm/trip         | Alarm/trip lock | Parameter reference   |
|--------|--|---------|--------------------|-----------------|---|
| 38     | Internal fault                         | –       | X                  | X               | –   |
| 39     | Heat sink sensor                       | –       | X                  | X               | –   |
| 40     | Overload of digital output terminal 27 | (X)     | –                  | –               | <i>Parameter 5-00 Digital I/O Mode, parameter 5-01 Terminal 27 Mode</i> |
| 41     | Overload of digital output terminal 29 | (X)     | –                  | –               | <i>Parameter 5-00 Digital I/O Mode, parameter 5-02 Terminal 29 Mode</i> |
| 42     | Ovrlid X30/6-7                         | (X)     | –                  | –               | –   |
| 43     | Ext. supply (option)                   | X       | –                  | –               | –   |
| 45     | Ground fault 2                         | –       | X <sup>(1)</sup>   | X               | <i>Parameter 14-90.5 Fault Level</i>                                    |
| 46     | Pwr. card supply                       | –       | X                  | X               | –   |
| 47     | 24 V supply low                        | X       | X                  | X               | –   |
| 48     | 1.8 V supply low                       | –       | X                  | X               | –   |
| 50     | AMA calibration failed                 | –       | X                  | –               | –   |
| 51     | AMA check $U_{nom}$ and $I_{nom}$      | –       | X                  | –               | –   |
| 52     | AMA low $I_{nom}$                      | –       | X                  | –               | –   |
| 53     | AMA motor too big                      | –       | X                  | –               | –   |
| 54     | AMA motor too small                    | –       | X                  | –               | –   |
| 55     | AMA parameter out of range             | –       | X                  | –               | –   |
| 56     | AMA interrupted by user                | –       | X                  | –               | –   |
| 57     | AMA time-out                           | –       | X                  | –               | –   |
| 58     | AMA internal fault                     | X       | X                  | –               | –   |
| 59     | Current limit                          | X       | X                  | –               | <i>Parameter 14-24 Trip Delay at Current Limit</i>                      |
| 60     | External interlock                     | X       | X                  | –               | –   |
| 61     | Feedback error                         | (X)     | (X)                | –               | <i>Parameter 4-30 Motor Feedback Loss Function</i>                      |
| 62     | Output frequency at maximum limit      | X       | X                  | –               | –   |
| 63     | Mechanical brake low                   | –       | (X)                | –               | <i>Parameter 4-30 Motor Feedback Loss Function</i>                      |
| 64     | Voltage limit                          | X       | –                  | –               | –   |
| 65     | Control board overtemperature          | –       | X                  | X               | <i>Parameter 14-90.11 Fault Level</i>                                   |
| 66     | Heat sink temperature low              | X       | –                  | –               | –   |
| 67     | Option configuration has changed       | –       | X                  | –               | –   |
| 68     | Safe stop                              | (X)     | (X) <sup>(1)</sup> | –               | <i>Parameter 5-19 Terminal 37 Safe Stop</i>                             |

| Number | Description                        | Warning | Alarm/trip | Alarm/trip lock | Parameter reference   |
|--------|------------------------------------|---------|------------|-----------------|---|
| 69     | Pwr. card temp                     | –       | X          | X               | –   |
| 70     | Illegal FC configuration           | –       | –          | X               | –   |
| 73     | Safe stop auto restart             | (X)     | (X)        | –               | <i>Parameter 5-19 Terminal 37 Safe Stop</i>   |
| 76     | Power unit setup                   | X       | –          | –               | –   |
| 77     | Reduced power mode                 | X       | –          | –               | <i>Parameter 14-59 Actual Number of Inverter Units</i>  |
| 78     | Tracking error                     | (X)     | (X)        | –               | <i>Parameter 4-34 Tracking Error Function</i>   |
| 79     | Illegal PS config                  | –       | X          | X               | –   |
| 80     | Drive Initialized to default value | –       | X          | –               | –   |
| 81     | CSIV corrupt                       | –       | X          | –               | –   |
| 82     | CSIV parameter error               | –       | X          | –               | –   |
| 83     | Illegal option combination         | –       | –          | X               | –   |
| 88     | Option detection                   | –       | –          | X               | –   |
| 89     | Mechanical brake sliding           | X       | –          | –               | –   |
| 90     | Feedback monitor                   | (X)     | (X)        | –               | <i>Parameter 17-61 Feedback Signal Monitoring</i>   |
| 91     | Analog input 54 wrong settings     | –       | –          | X               | S202  |
| 99     | Locked rotor                       | –       | X          | X               | –   |
| 101    | Speed monitor                      | X       | X          | –               | –   |
| 104    | Mixing fans                        | X       | X          | –               | –   |
| 122    | Mot. rotat. unexp.                 | –       | X          | –               | –   |
| 123    | Motor mod. changed                 | –       | X          | –               | –   |
| 157    | Power limit mot.                   | –       | X          | –               | <i>Parameter 4-80 Power Limit Func. Motor Mode, parameter 4-82 Power Limit Motor Mode</i>                                   |
| 158    | Power limit gen.                   | –       | X          | –               | <i>Parameter 4-81 Power Limit Func. Generator Mode, parameter 4-83 Power Limit Generator Mode</i>                           |
| 200    | Emergency mode                     | X       | –          | –               |   |
| 201    | Emerg. m was active                | X       | –          | –               |   |
| 202    | Emerg. m limits exceeded           | X       | –          | –               |   |
| 210    | Position tracking                  | X       | X          | –               | <i>Parameter 4-70 Position Error Function, parameter 4-71 Maximum Position Error, parameter 4-72 Position Error Timeout</i> |

| Number | Description                              | Warning | Alarm/trip | Alarm/trip lock | Parameter reference   |
|--------|--|---------|------------|-----------------|---|
| 211    | Position limit                           | X       | X          | –               | <i>Parameter 3-06 Minimum Position, parameter 3-07 Maximum Position, parameter 4-73 Position Limit Function</i> |
| 212    | Homing not done                          | –       | X          | –               | <i>Parameter 17-80 Homing Function</i>  |
| 213    | Homing timeout                           | –       | X          | –               | <i>Parameter 17-85 Homing Timeout</i>   |
| 214    | No sensor input                          | –       | X          | –               | –   |
| 215    | Start fwd/rev                            | X       | X          | –               | <i>Parameter 4-74 Start Fwd/Rev Function</i>  |
| 216    | Touch timeout                            | –       | X          | –               | <i>Parameter 4-75 Touch Timeout</i>   |
| 220    | Configuration File Version not supported | X       | –          | –               | –   |
| 246    | Power card supply                        | –       | –          | X               | –   |
| 250    | New spare part                           | –       | –          | X               | –   |
| 251    | New type code                            | –       | X          | X               | –   |
| 280    | Emergency service warning                | X       | –          | –               | –   |
| 281    | Emergency OPR unexpected                 | X       | –          | –               | –   |
| 430    | PWM disabled                             | –       | X          | –               | –   |

<sup>1</sup> Cannot be auto reset via *parameter 14-20 Reset Mode*.

(X) Dependent on parameter.

A trip is the action following an alarm. The trip coasts the motor and is reset by pressing [Reset] or by a digital input (*parameter group 5-1\* Digital Inputs*). The original event that caused an alarm cannot damage the drive or cause dangerous conditions.

A trip lock is an action when an alarm occurs, which could damage the drive or connected parts. A trip lock situation can only be reset by cycling power.

### 7.1.3 Indicator Light

Table 1435: Indicator Light

|             |                |
|-------------|----------------|
| Warning     | Yellow         |
| Alarm       | Flashing red   |
| Trip locked | Yellow and red |

### 7.1.4 Alarm Word, Warning Word, and Extended Status Word

Table 1436: Description of Alarm Word

| Bit                                    | Hex      | Dec | Alarm word                        | Alarm word 2                        | Alarm word 3                        |
|--|----------|-----|-----------------------------------|-------------------------------------|-------------------------------------|
|  |          |     | <i>Parameter 16-90 Alarm Word</i> | <i>Parameter 16-91 Alarm Word 2</i> | <i>Parameter 16-97 Alarm Word 3</i> |
| <b>Alarm Word Extended Status Word</b> |          |     |                                   |                                     |                                     |
| 0                                      | 00000001 | 1   | Brake check (A28)                 | Servicetrip, read/ write            | Temp. input error                   |
| 1                                      | 00000002 | 2   | Pwr.card temp (A69)               | Servicetrip, (reserved)             | Memory module fault                 |

| Bit | Hex      | Dec        | Alarm word                        | Alarm word 2                        | Alarm word 3                        |
|-----|----------|------------|-----------------------------------|-------------------------------------|-------------------------------------|
|     |          |            | <i>Parameter 16-90 Alarm Word</i> | <i>Parameter 16-91 Alarm Word 2</i> | <i>Parameter 16-97 Alarm Word 3</i> |
| 2   | 00000004 | 4          | Earth fault (A14)                 | Servicetrip, typecode/spare part    | Internal fan error                  |
| 3   | 00000008 | 8          | Ctrl.card temp (A65)              | Servicetrip, (reserved)             | Sync. fault                         |
| 4   | 00000010 | 16         | Ctrl. word TO (A17)               | Servicetrip, (reserved)             | OPM fault                           |
| 5   | 00000020 | 32         | Overcurrent (A13)                 | Reserved                            | –                                   |
| 6   | 00000040 | 64         | Torque limit (A12)                | Reserved                            | Profibus converter invalid          |
| 7   | 00000080 | 128        | Motor th over (A11)               | Reserved                            | –                                   |
| 8   | 00000100 | 256        | Motor ETR over (A10)              | Reserved                            | –                                   |
| 9   | 00000200 | 512        | Inverter overld. (A9)             | Discharge high                      | –                                   |
| 10  | 00000400 | 1024       | DC under volt (A8)                | Start failed                        | –                                   |
| 11  | 00000800 | 2048       | DC over volt (A7)                 | Speed limit                         | –                                   |
| 12  | 00001000 | 4096       | Short circuit (A16)               | External interlock                  | –                                   |
| 13  | 00002000 | 8192       | Inrush fault (A33)                | Illegal option combi.               | –                                   |
| 14  | 00004000 | 16384      | Mains ph. loss (A4)               | No safety option                    | –                                   |
| 15  | 00008000 | 32768      | AMA not OK                        | Reserved                            | –                                   |
| 16  | 00010000 | 65536      | Live zero error (A2)              | Reserved                            | –                                   |
| 17  | 00020000 | 131072     | Internal fault (A38)              | KTY error                           | –                                   |
| 18  | 00040000 | 262144     | Brake overload (A26)              | Fans error                          | –                                   |
| 19  | 00080000 | 524288     | U phase loss (A30)                | ECB error                           | –                                   |
| 20  | 00100000 | 1048576    | V phase loss (A31)                | Hoist mechanical brake (A22)        | –                                   |
| 21  | 00200000 | 2097152    | W phase loss (A32)                | Reserved                            | –                                   |
| 22  | 00400000 | 4194304    | Fieldbus fault (A34)              | Reserved                            | –                                   |
| 23  | 00800000 | 8388608    | 24 V supply low (A47)             | Reserved                            | –                                   |
| 24  | 01000000 | 16777216   | Mains failure (A36)               | Reserved                            | –                                   |
| 25  | 02000000 | 33554432   | 1.8 V supply low (A48)            | Current limit (A59)                 | Emergency mode                      |
| 26  | 04000000 | 67108864   | Brake resistor (A25)              | Motor rotating unexpectedly (A122)  | Sensor 4                            |
| 27  | 08000000 | 134217728  | Brake IGBT (A27)                  | Reserved                            | Sensor 3                            |
| 28  | 10000000 | 268435456  | Option change (A67)               | Reserved                            | Sensor 2                            |
| 29  | 20000000 | 536870912  | Drive initialized (A80)           | Encoder loss (A90)                  | Sensor 1                            |
| 30  | 40000000 | 1073741824 | Safe stop (A68)                   | PTC thermistor (A74)                | Load                                |
| 31  | 80000000 | 2147483648 | Mech. brake low (A63)             | Dangerous failure (A72)             | Stator                              |



Table 1437: Description of Warning Word

| Bit                 | Hex      | Dec       | Warning word                        | Warning word 2                        | Warning word 3                        |
|---------------------|----------|-----------|-------------------------------------|---------------------------------------|---------------------------------------|
|                     |          |           | <i>Parameter 16-92 Warning Word</i> | <i>Parameter 16-93 Warning Word 2</i> | <i>Parameter 16-98 Warning Word 3</i> |
| <b>Warning Word</b> |          |           |                                     |                                       |                                       |
| 0                   | 00000001 | 1         | Brake check (W28)                   | Start delayed                         | Temp. input error                     |
| 1                   | 00000002 | 2         | Pwr.card temp (A69)                 | Stop delayed                          | –                                     |
| 2                   | 00000004 | 4         | Earth fault (W14)                   | Reserved                              | Internal fan warning                  |
| 3                   | 00000008 | 8         | Ctrl.card temp (W65)                | Reserved                              | –                                     |
| 4                   | 00000010 | 16        | Ctrl. word TO (W17)                 | –                                     | –                                     |
| 5                   | 00000020 | 32        | Overcurrent (W13)                   | Reserved                              | Test MOC function                     |
| 6                   | 00000040 | 64        | Torque limit (W12)                  | Reserved                              | Profibus converter time warning       |
| 7                   | 00000080 | 128       | Motor th over (W11)                 | Reserved                              | EmcymodeActive                        |
| 8                   | 00000100 | 256       | Motor ETR over (W10)                | Reserved                              | EmcymodeHasBeenActive                 |
| 9                   | 00000200 | 512       | Inverter Overld (W9)                | Discharge high                        | EmcymodeLimits active                 |
| 10                  | 00000400 | 1024      | DC under volt (W8)                  | Multi-motor underload                 | EmcymodeServiceRequest due to limits  |
| 11                  | 00000800 | 2048      | DC over volt (W7)                   | Multi-motor overload                  | EmcymodeNotRedyToOperate              |
| 12                  | 00001000 | 4096      | DC voltage low (W6)                 | Compressor interlock                  | CBM Reserved                          |
| 13                  | 00002000 | 8192      | DC voltage high (W5)                | Mechanical brake sliding              | CBM Reserved                          |
| 14                  | 00004000 | 16384     | Mains ph. loss (W4)                 | Safe option warning                   | CBM Reserved                          |
| 15                  | 00008000 | 32768     | No motor (W3)                       | Auto DC braking                       | CBM Reserved                          |
| 16                  | 00010000 | 65536     | Live zero error (W2)                |                                       | CBM Reserved                          |
| 17                  | 00020000 | 131072    | 10 V low (W1)                       | KTY warn                              | CBM Reserved                          |
| 18                  | 00040000 | 262144    | Brake overload (W26)                | Fans warn                             | Load low S2                           |
| 19                  | 00080000 | 524288    | Brake resistor (W25)                | ECB warn                              | Load low                              |
| 20                  | 00100000 | 1048576   | Brake IGBT (W27)                    | Hoist mechanical brake (W22)          | Sensor 4 S2                           |
| 21                  | 00200000 | 2097152   | Speed limit (W49)                   | Reserved                              | Sensor 4                              |
| 22                  | 00400000 | 4194304   | Fieldbus fault (W34)                | Reserved                              | Sensor 3 S2                           |
| 23                  | 00800000 | 8388608   | 24 V supply low (W47)               | Reserved                              | Sensor 3                              |
| 24                  | 01000000 | 16777216  | Mains failure (W36)                 | Reserved                              | Sensor 2 S2                           |
| 25                  | 02000000 | 33554432  | Current limit (W59)                 | Power Limit Motor                     | Sensor 2                              |
| 26                  | 04000000 | 67108864  | Low temp (W66)                      | Power Limit Generator                 | Sensor 1 S2                           |
| 27                  | 08000000 | 134217728 | Voltage limit (W64)                 | Reserved                              | Sensor 1                              |

| Bit | Hex      | Dec        | Warning word                        | Warning word 2                        | Warning word 3                        |
|-----|----------|------------|-------------------------------------|---------------------------------------|---------------------------------------|
|     |          |            | <i>Parameter 16-92 Warning Word</i> | <i>Parameter 16-93 Warning Word 2</i> | <i>Parameter 16-98 Warning Word 3</i> |
| 28  | 10000000 | 268435456  | Encoder loss (W90)                  | Reserved                              | Load S2                               |
| 29  | 20000000 | 536870912  | Output freq. lim. (W62)             | BackEMF too high                      | Load                                  |
| 30  | 40000000 | 1073741824 | Safe stop (W68)                     | PTC thermistor (W74)                  | Stator S2                             |
| 31  | 80000000 | 2147483648 | Extended status word                | –                                     | Stator                                |

Table 1438: Description of Extended Status Word

| Bit                         | Hex      | Dec  | Ext. status word  | Ext. status word 2                        | Ext. status word 3                        |
|-----------------------------|----------|------|---|---|---|
|                             |          |      | <i>Parameter 16-94 Ext. Status Word</i>   | <i>Parameter 16-95 Ext. Status Word 2</i> | <i>Parameter 16-99 Ext. Status Word 3</i> |
| <b>Extended Status Word</b> |          |      |   |   |   |
| 0                           | 00000001 | 1    | Ramping   | Off                                       | High pressure stop                        |
| 1                           | 00000002 | 2    | AMA running   | Hand/auto                                 | Low pressure stop                         |
| 2                           | 00000004 | 4    | Start CW/CCW<br>start_possible is active, when the DI selections [12] OR [13] are active and the requested direction matches the reference sign | Profibus OFF1 active                      | Defrost                                   |
| 3                           | 00000008 | 8    | Slow down<br>slow down command active, for example via CTW bit 11 or DI   | Profibus OFF2 active                      | Pre/post lube                             |
| 4                           | 00000010 | 16   | Catch up<br>catch up command active, for example via CTW bit 12 or DI   | Profibus OFF3 active                      | User-defined alerts                       |
| 5                           | 00000020 | 32   | Feedback high<br>feedback >parameter 4-57 Warning Feedback High   | Relay 123 active                          | –   |
| 6                           | 00000040 | 64   | Feedback<br>low feedback <parameter 4-56 Warning Feedback Low   | Start prevented                           | –   |
| 7                           | 00000080 | 128  | Output current high<br>current >parameter 4-51 Warning Current High   | Control ready                             | –   |
| 8                           | 00000100 | 256  | Output current low<br>current <parameter 4-50 Warning Current Low   | Drive ready                               | –   |
| 9                           | 00000200 | 512  | Output freq high<br>speed >parameter 4-53 Warning Speed High  | Quick stop                                | –   |
| 10                          | 00000400 | 1024 | Output freq low   | DC brake                                  | –   |

| Bit | Hex      | Dec       | Ext. status word   | Ext. status word 2                        | Ext. status word 3                        |
|-----|----------|-----------|--|---|---|
|     |          |           | <i>Parameter 16-94 Ext. Status Word</i>  | <i>Parameter 16-95 Ext. Status Word 2</i> | <i>Parameter 16-99 Ext. Status Word 3</i> |
|     |          |           | speed < <i>parameter 4-52 Warning Speed Low</i>                                    |   |   |
| 11  | 00000800 | 2048      | Brake check OK<br>brake test NOT OK  | Stop                                      | –   |
| 12  | 00001000 | 4096      | Braking max.<br>BrakePower > Brakepowerlimit (2-12)                                | Standby                                   | –   |
| 13  | 00002000 | 8192      | Braking  | Freeze output request                     | –   |
| 14  | 00004000 | 16384     | Out of speed range   | Freeze output                             | –   |
| 15  | 00008000 | 32768     | OVC active   | Jog request                               | –   |
| 16  | 00010000 | 65536     | AC brake   | Jog                                       | –   |
| 17  | 00020000 | 131072    | Password timelock<br>number of allowed password trials exceeded - timelock active  | Start request                             | –   |
| 18  | 00040000 | 262144    | Password protection<br>0-61 = ALL_NO_ACCESS OR<br>BUS_NO_ACCESS OR<br>BUS_READONLY | Start                                     | –   |
| 19  | 00080000 | 524288    | Reference high<br>reference > <i>parameter 4-55 Warning Reference High</i>         | Start applied                             | –   |
| 20  | 00100000 | 1048576   | Reference low<br>reference < <i>parameter 4-54 Warning Reference Low</i>           | Start delay                               | –   |
| 21  | 00200000 | 2097152   | Local reference<br>reference site = REMOTE -> auto on pressed & active             | Sleep                                     | –   |
| 22  | 00400000 | 4194304   | Protection mode notification   | Sleep boost                               | –   |
| 23  | 00800000 | 8388608   | Unused   | Running/pipe filling                      | –   |
| 24  | 01000000 | 16777216  | Unused   | Drive bypass                              | –   |
| 25  | 02000000 | 33554432  | Unused   | Emergency mode                            | –   |
| 26  | 04000000 | 67108864  | Unused   | External interlock                        | –   |
| 27  | 08000000 | 134217728 | Unused   | Emerg. m limit exceeded                   | –   |
| 28  | 10000000 | 268435456 | Unused   | FlyStart active                           | –   |

| Bit | Hex      | Dec        | Ext. status word                        | Ext. status word 2                        | Ext. status word 3                        |
|-----|----------|------------|---|---|---|
|     |          |            | <i>Parameter 16-94 Ext. Status Word</i> | <i>Parameter 16-95 Ext. Status Word 2</i> | <i>Parameter 16-99 Ext. Status Word 3</i> |
| 29  | 20000000 | 536870912  | Unused                                  | –   | –   |
| 30  | 40000000 | 1073741824 | Unused                                  | –   | –   |
| 31  | 80000000 | 2147483648 | Protection mode                         | No function                               | –   |

The alarm words, warning words and extended status words can be read out via a serial bus or optional fieldbus for diagnostics. See also *parameter 16-94 Ext. Status Word*.

## 7.2 Descriptions of Warnings and Alarms

Depending on settings, FC 301/302 is able to give warnings or trigger alarms. Below, an extract of most common alarms and warnings can be found.

The following warning and alarm information defines each warning or alarm condition, provides the probable cause for the condition, and entails a remedy or troubleshooting procedure.

### 7.2.1 WARNING 1, 10 Volts Low

#### Cause

The control card voltage is less than 10 V from terminal 50. Remove some of the load from terminal 50, as the 10 V supply is overloaded. Maximum 15 mA or minimum 590 Ω.

A short circuit in a connected potentiometer or incorrect wiring of the potentiometer can cause this condition.

#### Troubleshooting

Remove the wiring from terminal 50.

- If the warning clears, the problem is with the wiring.
- If the warning does not clear, replace the control card.

### 7.2.2 WARNING/ALARM 2, Live Zero Error

#### Cause

This warning or alarm only appears if programmed in *parameter 6-01 Live Zero Timeout Function*. The signal on 1 of the analog inputs is less than 50% of the minimum value programmed for that input. Broken wiring or a faulty device sending the signal can cause this condition.

#### Troubleshooting

- Check connections on all analog mains terminals.
  - Control card terminals 53 and 54 for signals, terminal 55 common.
  - VLT® General Purpose I/O MCB 101 terminals 11 and 12 for signals, terminal 10 common.
  - VLT® Analog I/O Option MCB 109 terminals 1, 3, and 5 for signals, terminals 2, 4, and 6 common.
- Check that the drive programming and switch settings match the analog signal type.
- Perform an input terminal signal test.

### 7.2.3 WARNING/ALARM 3, No Motor

#### Cause

No motor is connected to the output of the drive.

### 7.2.4 WARNING/ALARM 4, Mains Phase Loss

#### Cause

A phase is missing on the supply side, or the mains voltage imbalance is too high. This message also appears for a fault in the input rectifier. Options are programmed in *parameter 14-12 Function at Mains Imbalance*.

#### Troubleshooting

- Check the supply voltage and supply currents to the drive.

### 7.2.5 WARNING 5, DC Link Voltage High

#### Cause

The DC-link voltage (DC) is higher than the high-voltage warning limit. The limit depends on the drive voltage rating. The unit is still active.

### 7.2.6 WARNING 6, DC Link Voltage Low

#### Cause

The DC-link voltage (DC) is lower than the low-voltage warning limit. The limit depends on the drive voltage rating. The unit is still active.

### 7.2.7 WARNING/ALARM 7, DC Overvoltage

#### Cause

If the DC-link voltage exceeds the limit, the drive trips after a certain time.

#### Troubleshooting

- Extend the ramp time.
- Change the ramp type.
- Activate the functions in *parameter 2-10 Brake Function*.
- Increase *parameter 14-26 Trip Delay at Inverter Fault*.
- If the alarm/warning occurs during a power sag, use kinetic back-up (*parameter 14-10 Mains Failure*).
- Connect a brake resistor.

### 7.2.8 WARNING/ALARM 8, DC Undervoltage

#### Cause

If the DC-link voltage drops below the undervoltage limit, the drive checks for 24 V DC back-up supply. If no 24 V DC back-up supply is connected, the drive trips after a fixed time delay. The time delay varies with unit size.

#### Troubleshooting

- Check that the supply voltage matches the drive voltage.
- Perform an input voltage test.
- Perform a soft-charge circuit test.

### 7.2.9 WARNING/ALARM 9, Inverter Overload

#### Cause

The drive has run with more than 100% overload for too long and is about to cut out. The counter for electronic thermal inverter protection issues a warning at 98% and trips at 100% with an alarm. The drive cannot be reset until the counter is below 90%.

#### Troubleshooting

- Compare the output current shown on the LCP with the drive rated current.
- Compare the output current shown on the LCP with the measured motor current.
- Show the thermal drive load on the LCP and monitor the value.
  - When running above the drive continuous current rating, the counter increases.
  - When running below the drive continuous current rating, the counter decreases.

### 7.2.10 WARNING/ALARM 10, Motor Overload Temperature

#### Cause

According to the electronic thermal protection (ETR), the motor is too hot.

This warning/alarm is controlled by *parameter 1-90 Motor Thermal Protection*:

- If the parameter is set to warning options, the drive issues a warning or an alarm when the counter is >90%.
- If the parameter is set to trip options, the drive trips when the counter reaches 100%.

The fault occurs when the motor runs with more than 100% overload for too long.

#### Troubleshooting

- Check for motor overheating.
- Check whether the motor is mechanically overloaded.

- Check that the motor current set in *parameter 1-24 Motor Current* is correct.
- Ensure that the motor data in *parameters 1-20 to 1-25* is set correctly.
- If an external fan is in use, check that it is selected in *parameter 1-91 Motor External Fan*.
- Run AMA in *parameter 1-29 Automatic Motor Adaptation (AMA)*. This tunes the drive to the motor more accurately and reduces thermal loading.

### 7.2.11 WARNING/ALARM 11, Motor Thermistor Overtemp

#### Cause

The motor thermistor indicates that the motor temperature is too high.

#### Troubleshooting

- Check for motor overheating.
- Check that the thermistor is securely connected.
- Check whether the motor is mechanically overloaded.
- When using terminal 53 or 54:
  - Check that the thermistor is connected correctly between either terminal 53 or 54 (analog voltage input) and terminal 50 (+10 V supply).
  - Check that the terminal switch for 53 and 54 is set for voltage.
  - Check that *parameter 1-93 Thermistor Resource* selects 53 or 54.
- When using terminal 18, 19, 31, 32, or 33 (digital inputs):
  - Check that the thermistor is connected correctly between the digital input terminal used (digital input PNP only) and terminal 50.
  - Select the terminal to use in *parameter 1-93 Thermistor Resource*.

### 7.2.12 WARNING/ALARM 12, Torque Limit

#### Cause

The torque has exceeded the value in *parameter 4-16 Torque Limit Motor Mode* or the value in *parameter 4-17 Torque Limit Generator Mode*. *Parameter 14-25 Trip Delay at Torque Limit* can change this warning from a warning-only condition to a warning followed by an alarm.

#### Troubleshooting

- If the motor torque limit is exceeded during ramp-up, extend the ramp-up time.
- If the generator torque limit is exceeded during ramp-down time, extend the ramp-down time.
- If torque limit occurs while running, increase the torque limit. Make sure that the system can operate safely at a higher torque.
- Check the application for excessive current draw on the motor.

### 7.2.13 WARNING/ALARM 13, Overcurrent

#### Cause

The inverter peak current limit (approximately 200% of the rated current) is exceeded. The warning lasts approximately 1.5 s, then the drive trips and issues an alarm. Shock loading or quick acceleration with high-inertia loads can cause this fault. If the acceleration during ramp-up is quick, the fault can also appear after kinetic back-up. If extended mechanical brake control is selected, a trip can be reset externally.

#### Troubleshooting

- Remove power and check if the motor shaft can be turned.
- Check that the motor size matches the drive.
- Check that the motor data is correct in *parameters 1-20 to 1-25*.

### 7.2.14 ALARM 14, Earth (Ground) Fault

#### Cause

There is current from the output phase to ground, either in the cable between the drive and the motor, or in the motor itself. The current sensors detect the ground fault by measuring current going out from the drive and current going into the drive from the motor. Ground fault is issued if the deviation of the 2 currents is too large. The current going out of the drive must be the same as the current going into the drive.

## Troubleshooting

- Remove power to the drive and repair the ground fault.
- Check for ground faults in the motor by measuring the resistance to ground of the motor cables and the motor with a megohmmeter.
- Reset any potential individual offset in the 3 current sensors in the drive. Perform a manual initialization or perform a complete AMA. This method is most relevant after changing the power card.

### 7.2.15 ALARM 15, Hardware Mismatch

#### Cause

A fitted option is not operational with the present control card hardware or software.

#### Troubleshooting

Record the value of the following parameters and contact Danfoss.

- *Parameter 15-40 FC Type.*
- *Parameter 15-41 Power Section.*
- *Parameter 15-42 Voltage.*
- *Parameter 15-43 Software Version.*
- *Parameter 15-45 Actual Typecode String.*
- *Parameter 15-49 SW ID Control Card.*
- *Parameter 15-50 SW ID Power Card.*
- *Parameter 15-60 Option Mounted.*
- *Parameter 15-61 Option SW Version* (for each option slot).

### 7.2.16 ALARM 16, Short Circuit

#### Cause

There is short-circuiting in the motor or motor wiring.

#### Troubleshooting

## ⚠ WARNING ⚠

### HAZARDOUS VOLTAGE

AC drives contain hazardous voltage when connected to AC mains or connected on the DC terminals. Failure to perform installation, start-up, and maintenance by qualified personnel can result in death or serious injury.

- Only qualified personnel must perform installation, start-up, and maintenance.

- Disconnect power before proceeding.
- Remove the power to the drive and repair the short circuit.

### 7.2.17 WARNING/ALARM 17, Control Word Timeout

#### Cause

There is no communication to the drive. The warning is only active when *parameter 8-04 Control Word Timeout Function* is NOT set to [0] Off.

If *parameter 8-04 Control Word Timeout Function* is set to [5] Stop and trip, a warning appears, and the drive ramps down to a stop and shows an alarm.

#### Troubleshooting

- Check the connections on the serial communication cable.
- Increase *parameter 8-03 Control Word Timeout Time*.
- Check the operation of the communication equipment.
- Verify that proper EMC installation was performed.

### 7.2.18 WARNING/ALARM 20, Temp. Input Error

#### Cause

The temperature sensor is not connected.

### 7.2.19 WARNING/ALARM 21, Parameter Error

#### Cause

The parameter is out of range. The parameter number is shown in the display.

#### Troubleshooting

- Set the affected parameter to a valid value.

### 7.2.20 WARNING/ALARM 22, Hoist Mechanical Brake

#### Cause

The value of this warning/alarm shows the type of warning/alarm.

0 = The torque reference was not reached before timeout (*parameter 2-27 Torque Ramp Up Time*).

1 = Expected brake feedback was not received before timeout (*parameter 2-23 Activate Brake Delay, parameter 2-25 Brake Release Time*).

### 7.2.21 WARNING 23, Internal Fan Fault

#### Cause

The fan warning function is a protective function that checks if the fan is running/mounted. The fan warning can be disabled in *parameter 14-53 Fan Monitor ([0] Disabled)*.

For drives with DC fans, a feedback sensor is mounted in the fan. If the fan is commanded to run and there is no feedback from the sensor, this warning appears. For drives with AC fans, the voltage to the fan is monitored.

#### Troubleshooting

- Check for proper fan operation.
- Cycle power to the drive and check that the fan operates briefly at start-up.
- Check the sensors on the control card.

### 7.2.22 WARNING 24, External Fan Fault

#### Cause

The fan warning function is a protective function that checks if the fan is running/mounted. The fan warning can be disabled in *parameter 14-53 Fan Monitor ([0] Disabled)*.

For drives with DC fans, a feedback sensor is mounted in the fan. If the fan is commanded to run and there is no feedback from the sensor, this warning appears. For drives with AC fans, the voltage to the fan is monitored.

#### Troubleshooting

- Check for proper fan operation.
- Cycle power to the drive and check that the fan operates briefly at start-up.
- Check the sensors on the heat sink.

### 7.2.23 WARNING 25, Brake Resistor Short Circuit

#### Cause

The brake resistor is monitored during operation. If a short circuit occurs, the brake function is disabled and the warning appears. The drive is still operational, but without the brake function.

#### Troubleshooting

- Remove the power to the drive and replace the brake resistor (refer to *parameter 2-15 Brake Check*).

### 7.2.24 WARNING/ALARM 26, Brake Resistor Power Limit

#### Cause

The power transmitted to the brake resistor is calculated as a mean value over the last 120 s of run time. The calculation is based on the DC-link voltage and the brake resistor value set in *parameter 2-16 AC Brake Max. Current*. The warning is active when the dissipated braking power is higher than 90% of the brake resistor power. If option [2] Trip is selected in *parameter 2-13 Brake Power Monitoring*, the drive trips when the dissipated braking power reaches 100%.

### 7.2.25 WARNING/ALARM 27, Brake Chopper Fault

#### Cause

The brake transistor is monitored during operation, and if a short circuit occurs, the brake function is disabled, and a warning is issued. The drive is still operational, but since the brake transistor has short-circuited, substantial power is transmitted to the brake resistor, even if it is inactive.



## Troubleshooting

- Remove the power to the drive and remove the brake resistor.

## 7.2.26 WARNING/ALARM 28, Brake Check Failed

## Cause

The brake resistor is not connected or not working.

## Troubleshooting

- Check *parameter 2-15 Brake Check*.

## 7.2.27 ALARM 29, Heat Sink Temp

## Cause

The maximum temperature of the heat sink is exceeded. The temperature fault is not reset until the temperature drops below a defined heat sink temperature. The trip and reset points are different based on the drive power size.

## Troubleshooting

Check for the following conditions:

- The ambient temperature is too high.
- The motor cables are too long.
- Incorrect airflow clearance above and below the drive.
- Blocked airflow around the drive.
- Damaged heat sink fan.
- Dirty heat sink.

## 7.2.28 ALARM 30, Motor Phase U Missing

## Cause

Motor phase U between the drive and the motor is missing.

## Troubleshooting

### ⚠ WARNING ⚠

**HAZARDOUS VOLTAGE**

AC drives contain hazardous voltage when connected to AC mains or connected on the DC terminals. Failure to perform installation, start-up, and maintenance by qualified personnel can result in death or serious injury.

- Only qualified personnel must perform installation, start-up, and maintenance.

- Disconnect power before proceeding.
- Remove the power from the drive and check motor phase U.

## 7.2.29 ALARM 31, Motor Phase V Missing

## Cause

Motor phase V between the drive and the motor is missing.

## Troubleshooting

### ⚠ WARNING ⚠

**HAZARDOUS VOLTAGE**

AC drives contain hazardous voltage when connected to AC mains or connected on the DC terminals. Failure to perform installation, start-up, and maintenance by qualified personnel can result in death or serious injury.

- Only qualified personnel must perform installation, start-up, and maintenance.

- Disconnect power before proceeding.
- Remove the power from the drive and check motor phase V.

## 7.2.30 ALARM 32, Motor Phase W Missing

## Cause

Motor phase W between the drive and the motor is missing.

Troubleshooting

**! W A R N I N G !**

**HAZARDOUS VOLTAGE**

AC drives contain hazardous voltage when connected to AC mains or connected on the DC terminals. Failure to perform installation, start-up, and maintenance by qualified personnel can result in death or serious injury.

- Only qualified personnel must perform installation, start-up, and maintenance.

- Disconnect power before proceeding.
- Remove the power from the drive and check motor phase W.

**7.2.31 ALARM 33, Inrush Fault**

**Cause**

Too many power-ups have occurred within a short time period.

**Troubleshooting**

- Let the unit cool to operating temperature.
- Check potential DC-link fault to ground.

**7.2.32 WARNING/ALARM 34, Fieldbus Communication Fault**

**Cause**

The fieldbus on the communication option card is not working.

**7.2.33 WARNING/ALARM 35, Option Fault**

**Cause**

An option alarm is received. The alarm is option-specific. The most likely cause is a power-up or a communication fault.

**7.2.34 WARNING/ALARM 36, Mains Failure**

**Cause**

This warning/alarm is only active if the supply voltage to the drive is lost and *parameter 14-10 Mains Failure* is not set to [0] *No Function*.

**Troubleshooting**

- Check the fuses to the drive and mains supply to the unit.

**7.2.35 ALARM 37, Phase Imbalance**

**Cause**

There is a current imbalance between the power units.

**7.2.36 ALARM 38, Internal Fault**

**Cause**

When an internal fault occurs, a code number defined in [Table 1439](#) is shown.

**Troubleshooting**

- Cycle power.
- Check that the option is properly installed.
- Check for loose or missing wiring.

It may be necessary to contact the Danfoss supplier or service department. Note the code number for further troubleshooting guidance.

**Table 1439: Internal Fault Codes**

| Number  | Text   |
|---------|--|
| 0       | The serial port cannot be initialized. Contact the Danfoss supplier or Danfoss service department. |
| 256–258 | The power EEPROM data is defective or too old. Replace the power card.                             |

| Number    | Text  |
|-----------|---|
| 512–519   | Internal fault. Contact the Danfoss supplier or Danfoss service department.   |
| 783       | Parameter value outside of minimum/maximum limits.  |
| 1024–1284 | Internal fault. Contact the Danfoss supplier or Danfoss service department.   |
| 1299      | The option software in slot A is too old.   |
| 1300      | The option software in slot B is too old.   |
| 1302      | The option software in slot C1 is too old.  |
| 1315      | The option software in slot A is not supported/allowed.   |
| 1316      | The option software in slot B is not supported/ allowed.  |
| 1318      | The option software in slot C1 is not supported/ allowed.   |
| 1379–2819 | Internal fault. Contact the Danfoss supplier or Danfoss service department.   |
| 1792      | Hardware reset of digital signal processor.   |
| 1793      | Motor-derived parameters not transferred correctly to the digital signal processor.   |
| 1794      | Power data not transferred correctly at power-up to the digital signal processor.   |
| 1795      | The digital signal processor has received too many unknown SPI telegrams. The AC drive also uses this fault code if the MCO does not power up correctly. This situation can occur due to poor EMC protection or improper grounding. |
| 1796      | RAM copy error.   |
| 2561      | Replace the control card.   |
| 2820      | LCP stack overflow.   |
| 2821      | Serial port overflow.   |
| 2822      | USB port overflow.  |
| 3072–5122 | Parameter value is outside its limits.  |
| 5123      | Option in slot A: Hardware incompatible with the control board hardware.  |
| 5124      | Option in slot B: Hardware incompatible with the control board hardware.  |
| 5125      | Option in slot C0: Hardware incompatible with the control board hardware.   |
| 5126      | Option in slot C1: Hardware incompatible with the control board hardware.   |
| 5376–6231 | Internal fault. Contact the Danfoss supplier or Danfoss service department.   |

### 7.2.37 ALARM 39, Heat Sink Sensor

#### Cause

There is no feedback from the heat sink temperature sensor.

The signal from the IGBT thermal sensor is not available on the power card.

#### Troubleshooting

- Check the ribbon cable between the power card and the gate drive card.
- Check for a defective power card.
- Check for a defective gate drive card.

### 7.2.38 WARNING 40, Overload of Digital Output Terminal 27

#### Troubleshooting

- Check the load connected to terminal 27 or remove the short-circuit connection.
- Check *parameter 5-00 Digital I/O Mode* and *parameter 5-01 Terminal 27 Mode*.

### 7.2.39 WARNING 41, Overload of Digital Output Terminal 29

#### Troubleshooting

- Check the load connected to terminal 29 or remove the short-circuit connection.
- Check *parameter 5-00 Digital I/O Mode* and *parameter 5-02 Terminal 29 Mode*.

### 7.2.40 WARNING 42, OvrlD X30/6-7

#### Troubleshooting

For terminal X30/6:

- Check the load connected to the terminal, or remove the short-circuit connection.
- Check *parameter 5-32 Term X30/6 Digi out (MCB 101)* (VLT® General Purpose I/O MCB 101).

For terminal X30/7:

- Check the load connected to the terminal, or remove the short-circuit connection.
- Check *parameter 5-33 Term X30/7 Digi Out (MCB 101)* (VLT® General Purpose I/O MCB 101).

### 7.2.41 ALARM 43, Ext. Supply

#### Cause

VLT® Extended Relay Option MCB 113 is mounted without 24 V DC.

#### Troubleshooting

Choose 1 of the following:

- Connect a 24 V DC external supply.
- Specify that no external supply is used via *parameter 14-80 Option Supplied by External 24VDC, [0] No*. A change in *parameter 14-80 Option Supplied by External 24VDC* requires a power cycle.

### 7.2.42 ALARM 45, Earth Fault 2

#### Cause

Ground fault.

#### Troubleshooting

- Check for proper grounding and loose connections.
- Check for proper wire size.
- Check the motor cables for short circuits or leakage currents.

### 7.2.43 ALARM 46, Power Card Supply

#### Cause

The supply on the power card is out of range. Another reason can be a defective heat sink fan.

There are 3 supplies generated by the switch mode supply (SMPS) on the power card:

- 24 V.
- 5 V.
- $\pm 18$  V.

When powered with VLT® 24 V DC Supply MCB 107, only 24 V and 5 V supplies are monitored. When powered with 3-phase mains voltage, all 3 supplies are monitored.

#### Troubleshooting

- Check for a defective power card.
- Check for a defective control card.
- Check for a defective option card.

- If a 24 V DC supply is used, verify proper supply power.
- Check for a defective heat sink fan.

#### 7.2.44 WARNING 47, 24 V Supply Low

##### Cause

The supply on the power card is out of range.

There are 3 supplies generated by the switch mode supply (SMPS) on the power card:

- 24 V.
- 5 V.
- $\pm 18$  V.

##### Troubleshooting

- Check for a defective power card.

#### 7.2.45 WARNING 48, 1.8 V Supply Low

##### Cause

The 1.8 V DC supply used on the control card is outside of the allowed limits. The supply is measured on the control card.

##### Troubleshooting

- Check for a defective control card.
- If an option card is present, check for overvoltage.

#### 7.2.46 WARNING 49, Speed Limit

##### Cause

The warning is shown when the speed is outside of the specified range in *parameter 4-11 Motor Speed Low Limit [RPM]* and *parameter 4-13 Motor Speed High Limit [RPM]*. When the speed is below the specified limit in *parameter 1-86 Trip Speed Low [RPM]* (except when starting or stopping), the drive trips.

#### 7.2.47 ALARM 50, AMA Calibration Failed

##### Cause

A calibration error has occurred.

##### Troubleshooting

- Contact the Danfoss supplier or Danfoss service department.

#### 7.2.48 ALARM 51, AMA Check Unom and Inom

##### Cause

The settings for motor voltage, motor current, and motor power are wrong.

##### Troubleshooting

- Check settings in *parameters 1-20 to 1-25*.

#### 7.2.49 ALARM 52, AMA Low Inom

##### Cause

The motor current is too low.

##### Troubleshooting

- Check the settings in *parameter 1-24 Motor Current*.

#### 7.2.50 ALARM 53, AMA Motor Too Big

##### Cause

The motor is too big for the AMA to operate.

##### Troubleshooting

- Check the settings in *parameter group 1-2\* Motor Data*.

#### 7.2.51 ALARM 54, AMA Motor Too Small

##### Cause

The motor is too small for the AMA to operate.

## Troubleshooting

- Check the settings in *parameter group 1-2\* Motor Data*.

**7.2.52 ALARM 55, AMA Parameter Out of Range**

## Cause

The AMA cannot run because the parameter values of the motor are out of the acceptable range.

## Troubleshooting

- Check the settings in *parameter group 1-2\* Motor Data*.

**7.2.53 ALARM 56, AMA Interrupted by User**

## Cause

The AMA is manually interrupted.

## Troubleshooting

- Re-run the AMA calibration.

**7.2.54 ALARM 57, AMA Internal Fault**

## Cause

Internal fault.

## Troubleshooting

Try to restart the AMA. Repeated restarts can overheat the motor.

**7.2.55 ALARM 58, AMA Internal Fault**

## Cause

Internal fault.

## Troubleshooting

Contact the Danfoss supplier.

**7.2.56 WARNING 59, Current Limit**

## Cause

The current is higher than the value in *parameter 4-18 Current Limit*.

## Troubleshooting

- Ensure that the motor data in *parameters 1-20 to 1-25* is set correctly.
- Increase the current limit if necessary. Ensure that the system can operate safely at a higher limit.

**7.2.57 WARNING 60, External Interlock**

## Cause

A digital input signal indicates a fault condition external to the drive. An external interlock has commanded the drive to trip.

## Troubleshooting

- Clear the external fault condition.
- To resume normal operation, apply 24 V DC to the terminal programmed for external interlock.
- Reset the drive.

**7.2.58 WARNING/ALARM 61, Feedback Error**

## Cause

An error between calculated speed and speed measurement from feedback device.

## Troubleshooting

- Check the settings for warning/alarm/disabling in *parameter 4-30 Motor Feedback Loss Function*.
- Set the tolerable error in *parameter 4-31 Motor Feedback Speed Error*.
- Set the tolerable feedback loss time in *parameter 4-32 Motor Feedback Loss Timeout*.

**7.2.59 WARNING 62, Output Frequency at Maximum Limit**

## Cause

The output frequency has reached the value set in *parameter 4-19 Max Output Frequency*.

## Troubleshooting

- Check the application for possible causes.
- Increase the output frequency limit. Be sure that the system can operate safely at a higher output frequency.

The warning clears when the output drops below the maximum limit.

### 7.2.60 ALARM 63, Mechanical Brake Low

#### Cause

The actual motor current has not exceeded the release brake current within the start delay time window.

### 7.2.61 WARNING 64, Voltage Limit

#### Cause

The load and speed combination demands a motor voltage higher than the actual DC-link voltage.

### 7.2.62 WARNING/ALARM 65, Control Card Overtemperature

#### Cause

The cutout temperature of the control card has exceeded the upper limit.

#### Troubleshooting

- Check that the ambient operating temperature is within the limits.
- Check for clogged filters.
- Check fan operation.
- Check the control card.

### 7.2.63 WARNING 66, Heat Sink Temperature Low

#### Cause

The drive is too cold to operate. This warning is based on the temperature sensor in the IGBT module.

#### Troubleshooting

- Increase the ambient temperature of the unit.
- Supply a trickle amount of current to the drive whenever the motor is stopped by setting *parameter 2-00 DC Hold/Preheat Current* to 5% and *parameter 1-80 Function at Stop*.

### 7.2.64 ALARM 67, Option Module Configuration has Changed

#### Cause

One or more options have either been added or removed since the last power-down.

#### Troubleshooting

- Check that the configuration change is intentional and reset the unit.

### 7.2.65 ALARM 68, Safe Stop Activated

#### Cause

Safe Torque Off (STO) has been activated.

#### Troubleshooting

- To resume normal operation, apply 24 V DC to terminal 37, then send a reset signal (via bus, digital I/O, or by pressing [Reset]).

### 7.2.66 ALARM 70, Illegal FC Configuration

#### Cause

The control card and power card are incompatible.

#### Troubleshooting

- To check compatibility, contact the Danfoss supplier with the type code from the unit nameplate and the part numbers on the cards.

### 7.2.67 ALARM 71, PTC 1 Safe Stop

#### Cause

Because the motor is too warm, the VLT® PTC Thermistor Card MCB 112 activated the Safe Torque Off (STO).

## Troubleshooting

- Once the motor temperature reaches an acceptable level and the digital input from MCB 112 is deactivated, perform 1 of the following:
  - Send a reset signal via bus or digital I/O.
  - Press [Reset].

### 7.2.68 ALARM 72, Dangerous Failure

#### Cause

Safe Torque Off (STO) with trip lock.

#### Troubleshooting

An unexpected combination of STO commands has occurred:

- VLT® PTC Thermistor Card MCB 112 enables X44/10, but STO is not enabled.
- MCB 112 is the only device using STO (specified through selection [4] PTC 1 alarm or [5] PTC 12 warning in parameter 5-19 Terminal 37 Safe Stop). STO is activated, but X44/10 is not activated.

### 7.2.69 WARNING 73, Safe Stop Auto Restart

#### Cause

STO activated.

#### Troubleshooting

- With automatic restart enabled, the motor can start when the fault is cleared.

### 7.2.70 ALARM 74, PTC Thermistor

#### Cause

The PTC is not working. Alarm is related to VLT® PTC Thermistor Card MCB 112.

### 7.2.71 ALARM 75, Illegal Profile Sel.

#### Cause

There was an attempt to write the parameter value while the motor was running.

#### Troubleshooting

- Stop the motor before writing the MCO profile to *parameter 8-10 Control Word Profile*.

### 7.2.72 Warning 76, Power Unit Setup

#### Cause

The required number of power units does not match the detected number of active power units.

#### Troubleshooting

- When replacing a drive module, this warning can occur if the power-specific data in the module power card does not match the rest of the drive. Confirm that the spare part and its power card are the correct part number.

### 7.2.73 WARNING 77, Reduced Power Mode

#### Cause

The drive is operating in reduced power mode (less than allowed number of inverter sections). The warning is generated on power cycle when the drive is set to run with fewer inverters and remains on.

### 7.2.74 ALARM 78, Tracking Error

#### Cause

The difference between setpoint value and actual value exceeds the value in *parameter 4-35 Tracking Error*.

#### Troubleshooting

- Disable the function or select an alarm/warning in *parameter 4-34 Tracking Error Function*.
- Investigate the mechanics around the load and motor. Check feedback connections from motor encoder to drive.
- Select motor feedback function in *parameter 4-30 Motor Feedback Loss Function*.
- Adjust the tracking error band in *parameter 4-35 Tracking Error* and *parameter 4-37 Tracking Error Ramping*.



### 7.2.75 ALARM 79, Illegal Power Section Configuration

#### Cause

The scaling card has an incorrect part number or is not installed. The MK102 connector on the power card could not be installed.

### 7.2.76 ALARM 80, Drive Initialized to Default Value

#### Cause

Parameter settings are initialized to default settings after a manual reset.

#### Troubleshooting

- To clear the alarm, reset the unit.

### 7.2.77 ALARM 81, CSIV Corrupt

#### Cause

The CSIV file has syntax errors.

### 7.2.78 ALARM 82, CSIV Parameter Error

#### Cause

CSIV failed to initialize a parameter.

### 7.2.79 ALARM 83, Illegal Option Combination

#### Cause

The mounted options are incompatible.

### 7.2.80 ALARM 84, No Safety Option

#### Cause

The safety option was removed without applying a general reset.

#### Troubleshooting

- Reconnect the safety option.

### 7.2.81 ALARM 88, Option Detection

#### Cause

A change in the option layout is detected. *Parameter 14-89 Option Detection* is set to [0] Frozen configuration and the option layout has been changed.

#### Troubleshooting

- To apply the change, enable option layout changes in *parameter 14-89 Option Detection*.
- Alternatively, restore the correct option configuration.

### 7.2.82 WARNING 89, Mechanical Brake Sliding

#### Cause

The hoist brake monitor detects a motor speed exceeding 10 RPM.

### 7.2.83 ALARM 90, Feedback Monitor

#### Troubleshooting

- Check the connection to the encoder/resolver option and, if necessary, replace the VLT® Encoder Input MCB 102 or VLT® Resolver Input MCB 103.

### 7.2.84 ALARM 91, Analog Input 54 Wrong Settings

#### Troubleshooting

- Set switch S202 in position OFF (voltage input) when a KTY sensor is connected to analog input terminal 54.

### 7.2.85 ALARM 99, Locked Rotor

#### Cause

The rotor is blocked.

## Troubleshooting

- Check if the motor shaft is locked.
- Check if the start current triggers the current limit set in *parameter 4-18 Current Limit*.
- Check if it increases the value in *parameter 30-23 Locked Rotor Detection Time [s]*.

**7.2.86 WARNING/ALARM 104, Mixing Fan Fault**

## Cause

The fan is not operating. The fan monitor checks that the fan is spinning at power-up or whenever the mixing fan is turned on. The mixing fan fault can be configured as a warning or an alarm in *parameter 14-53 Fan Monitor*.

## Troubleshooting

- Cycle power to the drive to determine if the warning/alarm returns.

**7.2.87 WARNING/ALARM 122, Mot. Rotat. Unexp.**

## Cause

The drive performs a function that requires the motor to be at standstill, for example DC hold for PM motors.

**7.2.88 WARNING 123, Motor Mod. Changed**

## Cause

The motor selected in *parameter 1-11 Motor Model* is not correct.

## Troubleshooting

- Check the motor model.

**7.2.89 WARNING/ALARM 157, Power Limit Mot.**

## Cause

The output power exceeds the value defined in *parameter 4-82 Power Limit Motor Mode*.

**7.2.90 WARNING/ALARM 158, Power Limit Gen.**

## Cause

The generating power exceeds the value defined in *parameter 4-83 Power Limit Generator Mode*.

**7.2.91 WARNING 163, ATEX ETR Cur.Lim.Warning**

## Cause

The drive has run above the characteristic curve for more than 50 s. The warning is activated at 83% and deactivated at 65% of the allowed thermal overload.

**7.2.92 ALARM 164, ATEX ETR Cur.Lim.Alarm**

## Cause

Running above the characteristic curve for more than 60 s within a period of 600 s activates the alarm, and the drive trips.

**7.2.93 WARNING 165, ATEX ETR Freq.Lim.Warning**

## Cause

The drive has run for more than 50 s below the allowed minimum frequency (*parameter 1-98 ATEX ETR Interpol. Points Freq.*).

**7.2.94 ALARM 166, ATEX ETR Freq.Lim.Alarm**

## Cause

The drive has run for more than 60 s (in a period of 600 s) below the allowed minimum frequency (*parameter 1-98 ATEX ETR Interpol. Points. Freq.*).

**7.2.95 WARNING/ALARM 210, Position Tracking**

## Cause

The actual position error exceeds the value in *parameter 4-71 Maximum Position Error*. *Parameter 4-70 Position Error Function* defines whether this is a warning or an alarm.

### 7.2.96 WARNING/ALARM 211, Position Limit

#### Cause

The position is outside the limits defined in *parameter 3-06 Minimum Position* and *parameter 3-07 Maximum Position*. *Parameter 4-73 Position Limit Function* defines the function for this warning/alarm.

### 7.2.97 WARNING/ALARM 212, Homing not Done

#### Cause

A homing function is selected in *parameter 17-80 Homing Function* and absolute positioning is executed before homing is completed.

### 7.2.98 ALARM 213, Homing Timeout

#### Cause

Homing was started but did not finish within the time defined in *parameter 17-85 Homing Timeout*.

### 7.2.99 ALARM 214, No Sensor Input

#### Cause

A homing process with a homing function that requires a sensor, or touch probe positioning is started with no input defined for the sensor.

### 7.2.100 WARNING/ALARM 215, Start Fwd/Rev

#### Cause

One of the hardware end-limit options, *[12] Enable Start Forward* or *[13] Enable Start Reverse* is active.

### 7.2.101 WARNING/ALARM 216, Touch Timeout

#### Cause

A touch probe sensor is not found within the time in *parameter 4-75 Touch Timeout*. The timeout timer is started as soon as the touch probe positioning is activated even if the application is not moving.

### 7.2.102 WARNING 220, Configuration File Version not Supported

#### Cause

The drive does not support the current configuration file version. Customization is aborted.

### 7.2.103 WARNING 250, New Spare Part

#### Cause

A component in the drive system has been replaced.

#### Troubleshooting

- Reset the drive system to restore normal operation.

### 7.2.104 WARNING 251, New Typecode

#### Cause

The power card or other components have been replaced, and the typecode has changed.

### 7.2.105 ALARM 430, PWM Disabled

#### Cause

The PWM on the power card is disabled.

## Index

|                                   |               |                              |                     |
|-----------------------------------|---------------|------------------------------|---------------------|
| <b>A</b>                          |               | Motor                        |                     |
| Alarms                            |               | Warning.....                 | 701,702,705,705,705 |
| List of.....                      | 700           |                              |                     |
| Automatic motor adaptation        |               | <b>N</b>                     |                     |
| Preventing motor overheating..... | 701           | Numerical display.....       | 31                  |
| Alarms.....                       | 709           |                              |                     |
| <b>B</b>                          |               | <b>P</b>                     |                     |
| Brake resistor.....               | 704, 704      | Phase imbalance.....         | 706                 |
|                                   |               | Potentiometer reference..... | 19                  |
|                                   |               | Pulse start/stop.....        | 17                  |
| <b>D</b>                          |               | <b>Q</b>                     |                     |
| DC overvoltage.....               | 701           | Quick menu.....              | 25                  |
| Display mode.....                 | 21            | Quick transfer.....          | 21                  |
| Drive                             |               | <b>R</b>                     |                     |
| Initialization.....               | 33,33         | Reset.....                   | 711                 |
| <b>E</b>                          |               | <b>S</b>                     |                     |
| External interlock.....           | 710           | Safety instructions.....     | 13                  |
| <b>F</b>                          |               | Short circuit                |                     |
| Factory default settings.....     | 33            | Alarm.....                   | 703                 |
| Fans                              |               | Speed up/speed down.....     | 18                  |
| Internal fault.....               | 704           | Start/Stop.....              | 17                  |
| External fault.....               | 704           | STO                          |                     |
| Mixing fan fault.....             | 714           | Warning.....                 | 711,711,712,712     |
| Fieldbus                          |               | Switches                     |                     |
| Warning.....                      | 706           | Disconnect.....              | 13                  |
| Fuses                             |               | <b>T</b>                     |                     |
| Warning.....                      | 706           | Thermistor                   |                     |
| <b>H</b>                          |               | Warning.....                 | 712                 |
| Heat sink.....                    | 704, 705, 707 | Torque                       |                     |
| <b>I</b>                          |               | Warning.....                 | 702                 |
| Installation                      |               | Troubleshooting.....         | 700                 |
| Initialization.....               | 33,33         | <b>U</b>                     |                     |
| <b>L</b>                          |               | Unintended start.....        | 13                  |
| LCP.....                          | 21            | <b>V</b>                     |                     |
| List of warnings and alarms.....  | 700           | Voltage                      |                     |
| <b>M</b>                          |               | Safety warning.....          | 13,703,705,705,706  |
| Main menu mode.....               | 28            | <b>W</b>                     |                     |
| Mains                             |               | Warnings                     |                     |
| Warning.....                      | 700,706       | List of.....                 | 700                 |
| Mechanical brake control.....     | 702           |                              |                     |

## VLT Drives Glossary

### 6

**60° AVM**

60° asynchronous vector modulation (*parameter 14-00 Switching Pattern*).

### A

**Actual position**

The actual position from an encoder, or a value that the motor control calculates in open loop. The drive uses the actual position as feedback for position PI.

**Analog reference**

A signal transmitted to the analog inputs 53 or 54 (voltage or current).

**Analog inputs**

The analog inputs are used for controlling various functions of the drive. There are 2 types of analog inputs:  
Current input, 0–20 mA, and 4–20 mA  
Voltage input, -10 V DC to +10 V DC.

**Analog outputs**

The analog outputs can supply a signal of 0–20 mA, 4–20 mA.

**Automatic motor adaptation, AMA**

AMA algorithm determines the electrical parameters for the connected motor at standstill.

### B

**BDM**

A BDM is a drive module which consists of a power converter module and a control and regulating device for speed, torque, current, or voltage.

**Binary reference**

A signal transmitted to the serial communication port.

**Brake resistor**

The brake resistor is a module capable of absorbing the brake power generated in regenerative braking. This regenerative brake power increases the DC-link voltage and a brake chopper ensures that the power is transmitted to the brake resistor.

**Break-away torque**

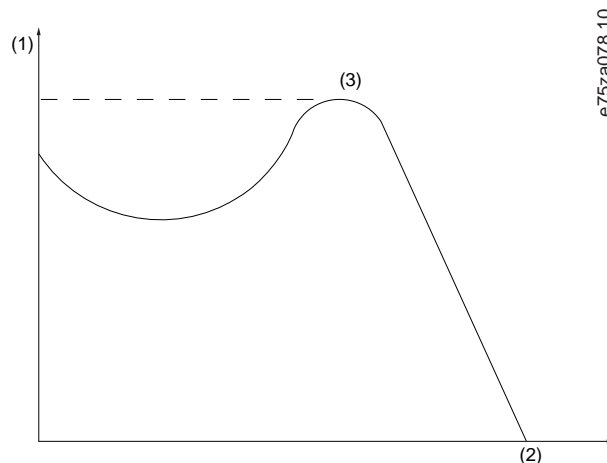

### C

**CBM**

Condition Based Monitoring monitors the machine condition and performance when the drive is in service and detects mechanical, motor, or application failures in advance. Corrective actions can be performed before the process or application is impacted.

**CDM**

A CDM is a drive system without the motor and without the measuring sensors, which are mechanically connected to the motor shaft. The drive system consists of, but is not restricted to, the BDM and extensions, such as the feed module and auxiliary equipment.

|                           |   |
|---------------------------|---|
| <b>CT characteristics</b> | Constant-torque characteristics used for all applications such as conveyor belts, displacement pumps, and cranes.   |
| <b>Commanded position</b> | The actual position reference calculated by the profile generator. The drive uses the commanded position as setpoint for position PI.   |
| <b>Control command</b>    | Start and stop the connected motor with LCP and digital inputs.<br>Functions are divided into 2 groups.<br>Functions in group 1 have higher priority than functions in group 2. |

**Table 1: Function Groups**

| Group 1   | Group 2   |
|---|---|
| Reset, coast stop, reset and coast stop, quick stop, DC brake, stop, the LCP [OFF] key. | Start, pulse start, reversing, start reversing, jog, freeze output. |

**D**

|                        |  |
|------------------------|--|
| <b>DSP</b>             | Digital signal processor.  |
| <b>Digital inputs</b>  | The digital inputs can be used for controlling various functions of the drive.             |
| <b>Digital outputs</b> | The drive features 2 solid-state outputs that can supply a 24 V DC (maximum 40 mA) signal. |

**E**

|            |  |
|------------|--|
| <b>ETR</b> | Electronic thermal relay is a thermal load calculation based on present load and time. Its purpose is to estimate the motor temperature. |
|------------|--|

**F**

|                        |  |
|------------------------|--|
| <b>FC standard bus</b> | Includes RS485 bus with FC protocol or MC protocol. See <i>parameter 8-30 Protocol</i> . |
| $f_M$                  | Motor frequency.   |
| $f_{M,N}$              | Rated motor frequency (nameplate data).  |
| $f_{MAX}$              | Maximum motor frequency.   |
| $f_{MIN}$              | Minimum motor frequency.   |
| $f_{jog}$              | Motor frequency when the jog function is activated (via digital terminals).              |

**H**

|                   |   |
|-------------------|---|
| <b>Hiperface®</b> | Hiperface® is a registered trademark by Stegmann. |
|-------------------|---|

**I**

|                     |  |
|---------------------|--|
| $I_M$               | Motor current (actual).  |
| $I_{M,N}$           | Rated motor current (nameplate data).  |
| <b>IMC</b>          | Integrated Motion Controller (IMC) is a functionality that enables an AC drive to perform high-precision positioning and synchronization operations without the need for additional modules or hardware. |
| $I_{VLT,MAX}$       | Maximum output current.  |
| $I_{VLT,N}$         | Rated output current supplied by the drive.  |
| <b>Initializing</b> | If initializing is carried out in <i>parameter 14-22 Operation Mode</i> , the drive returns to the default setting.  |

|                                  |  |
|----------------------------------|--|
| <b>Intermittent duty cycle</b>   | An intermittent duty rating refers to a sequence of duty cycles. Each cycle consists of an on-load and an off-load period. The operation can be either periodic duty or non-periodic duty.   |
| <b>L</b>                         |  |
| <b>LCP</b>                       | The local control panel makes up a complete interface for control and programming of the drive. The control panel is detachable and can be installed up to 3 m (10 ft) from the drive, that is, in a front panel with the installation kit option. |
| <b>lsb</b>                       | Least significant bit.   |
| <b>M</b>                         |  |
| <b>MCM</b>                       | Short for "mille circular mil", an American measuring unit for cable cross-section. 1 MCM=0.5067 mm <sup>2</sup>   |
| <b>Motor running</b>             | Torque generated on output shaft and speed from 0 RPM to maximum speed on motor.   |
| <b>msb</b>                       | Most significant bit.  |
| <b>N</b>                         |  |
| <b>NLCP</b>                      | Numerical local control panel interface for control and programming of the drive. The display is numerical and the panel is used to show process values. The NLCP has no storage and copy functions.   |
| <b>n<sub>M,N</sub></b>           | Nominal motor speed (nameplate data).  |
| <b>n<sub>s</sub></b>             | Synchronous motor speed.<br>$n_s = \frac{2 \times \text{par. 1} - 23 \times 60 \text{ s}}{\text{par. 1} - 39}$   |
| <b>n<sub>slip</sub></b>          | Motor slip.  |
| <b>O</b>                         |  |
| <b>Online/offline parameters</b> | Changes to online parameters are activated immediately after the data value is changed. Press [OK] to activate changes to off-line parameters.   |
| <b>P</b>                         |  |
| <b>PCD</b>                       | Process-control data.  |
| <b>PDS</b>                       | The PDS is a speed control system for an electric motor, including the CDM and motor, but without the equipment which it powers.   |
| <b>P<sub>M,N</sub></b>           | Rated motor power (nameplate data in kW or hp).  |
| <b>Position error</b>            | Position error is the difference between the actual position and the commanded position. The position error is the input for the position PI controller.   |
| <b>Position unit</b>             | The physical unit for position values.   |
| <b>Power cycle</b>               | Switch off the mains until the display (LCP) is dark, then turn power on again.  |
| <b>Power factor</b>              | The power factor is the relation between I <sub>1</sub> and I <sub>RMS</sub> .<br>$\text{Power factor} = \frac{\sqrt{3} \times U \times I_{1\cos\phi}}{\sqrt{3} \times U \times I_{RMS}}$<br>The power factor for 3-phase control:                 |

$$\text{Power factor} = \frac{I_1 \times \cos\phi_1}{I_{\text{RMS}}} = \frac{I_1}{I_{\text{RMS}}} \text{ since } \cos\phi_1 = 1$$

The power factor indicates to which extent the drive imposes a load on the mains supply.

The lower the power factor, the higher the  $I_{\text{RMS}}$  for the same kW performance.

$$I_{\text{RMS}} = \sqrt{I_1^2 + I_5^2 + I_7^2 + \dots + I_n^2}$$

In addition, a high-power factor indicates that the different harmonic currents are low.

The DC coils in the drive produce a high-power factor, which minimizes the imposed load on the mains supply.

**Preset reference**

A defined preset reference to be set from -100% to +100% of the reference range. Selection of 8 preset references via the digital terminals.

**Process PID**

The PID control maintains the required speed, pressure, temperature, and so on, by adjusting the output frequency to match the varying load.

**Pulse input/incremental encoder**

An external, digital pulse transmitter used for feeding back information on motor speed. The encoder is used in applications where great accuracy in speed control is required.

**Pulse reference**

A pulse frequency signal transmitted to the digital inputs (terminal 29 or 33).

**R****RCD**

Residual-current device.

**Ref<sub>MAX</sub>**

Determines the relationship between the reference input at 100-% full scale value (typically 10 V, 20 mA) and the resulting reference. The maximum reference value is set in *parameter 3-03 Maximum Reference*.

**Ref<sub>MIN</sub>**

Determines the relationship between the reference input at 0-% value (typically 0 V, 0 mA, 4 mA) and the resulting reference. The minimum reference value is set in *parameter 3-02 Minimum Reference*.

**S****SFAVM**

Switching pattern called stator flux-oriented asynchronous vector modulation (*parameter 14-00 Switching Pattern*).

**SLC**

The SLC (smart logic control) is a sequence of user-defined actions executed when the associated user-defined events are evaluated as true by the SLC. (See *parameter group 13-\*\* Smart Logic Control*).

**STW**

Status word.

**Safe Torque Off (STO)**

The STO function brings the drive safely to a no-torque state.

**Setup**

Save parameter settings in 4 setups. Change between the 4 parameter setups and edit 1 setup, while another setup is active.

**Slip compensation**

The drive compensates for the motor slip by giving the frequency a supplement that follows the measured motor load keeping the motor speed almost constant.

**Start-disable command**

A start command belonging to Group 2 control commands, see the *table Function Groups* under *Control Command*.

**Stop command**

A stop command belonging to Group 1 control commands, see the *table Function Groups* under *Control Command*.



## T

|                             |  |
|-----------------------------|--|
| <b>THD</b>                  | Total harmonic distortion states the total contribution of harmonics.  |
| <b><math>T_{M,N}</math></b> | Rated torque (motor).  |
| <b>Target position</b>      | The final target position specified by positioning commands. The profile generator uses this position to calculate the speed profile.  |
| <b>Thermistor</b>           | A temperature-dependent resistor placed on the drive or the motor.   |
| <b>Trip</b>                 | A state entered in fault situations, for example, if the drive is subject to an overtemperature or when the drive is protecting the motor, process, or mechanism. The drive prevents a restart until the cause of the fault has disappeared. To cancel the trip state, restart the drive. Do not use the trip state for personal safety.   |
| <b>Trip lock</b>            | The drive enters this state in fault situations to protect itself. The drive requires physical intervention, for example when there is a short circuit on the output. A trip lock can only be canceled by disconnecting mains, removing the cause of the fault, and reconnecting the drive. Restart is prevented until the trip state is canceled by activating reset or, sometimes, by being programmed to reset automatically. Do not use the trip lock state for personal safety. |

## U

|                                 |                                       |
|---------------------------------|---------------------------------------|
| <b><math>U_M</math></b>         | Motor voltage.                        |
| <b><math>U_{M,N}</math></b>     | Rated motor voltage (nameplate data). |
| <b><math>U_{VLT,MAX}</math></b> | Maximum output voltage.               |

## V

|                           |   |
|---------------------------|---|
| <b>VT characteristics</b> | Variable torque characteristics typical for many pumps and fans.  |
| <b>VVC<sup>+</sup></b>    | If compared with standard voltage/frequency ratio control, Voltage Vector Control (VVC <sup>+</sup> ) improves the dynamics and the stability, both when the speed reference is changed and in relation to the load torque. |

## H

|                                |   |
|--------------------------------|---|
| <b><math>\eta_{VLT}</math></b> | The efficiency of the drive is defined as the ratio between the power output and the power input. |
|--------------------------------|---|

**Danfoss A/S**  
Ulsnaes 1  
DK-6300 Graasten  
[vlt-drives.danfoss.com](http://vlt-drives.danfoss.com)

.....  
Danfoss can accept no responsibility for possible errors in catalogs, brochures, and other printed material. Danfoss reserves the right to alter its products without notice. This also applies to products already on order provided that such alterations can be made without subsequential changes being necessary in specifications already agreed. All trademarks in this material are property of the respective companies. Danfoss and the Danfoss logotype are trademarks of Danfoss A/S. All rights reserved.  
.....

