

Installation Guide

ITC, ITL & ITD Immersion Thermostats

Application for controlling, motorized valves, hot water cylinders and central heating pumps

Installation steps

1. Installation must be done by an authorised electrician
2. Unscrew mounting screws until the Cylinder Thermostat can be mounted on the pocket,
3. Insert the thermistors fully into the pocket and mount the thermostat onto the pocket,
4. Tighten the Mounting screws and check the thermostat is secure, care should be taken not to over tighten the screws and cause damage,
5. Connect wiring as per diagram.

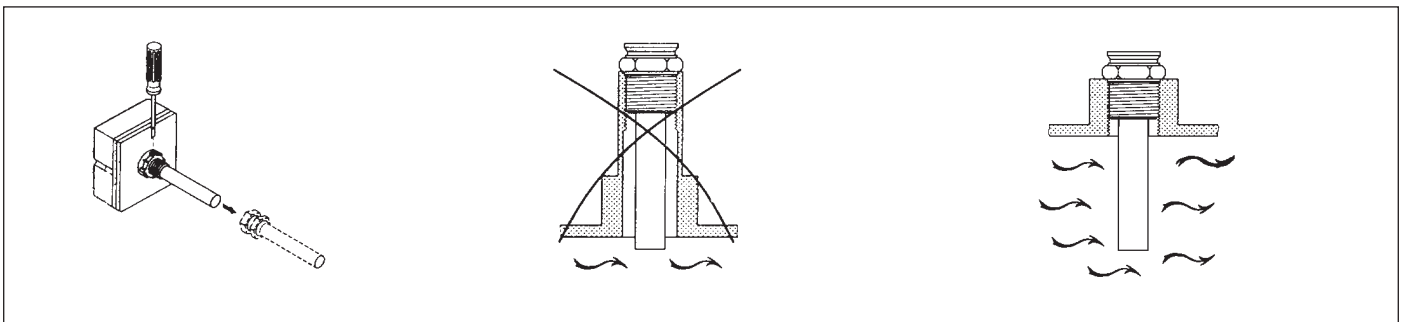

fig. 1.0

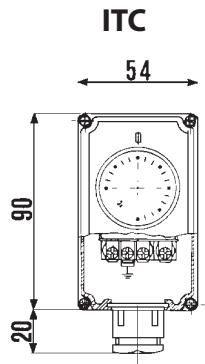

fig. 2.0

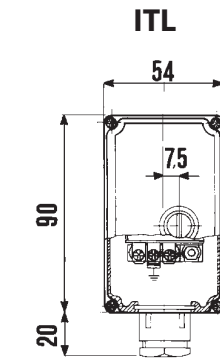

fig. 3.0

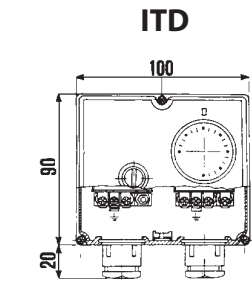

fig. 1.1

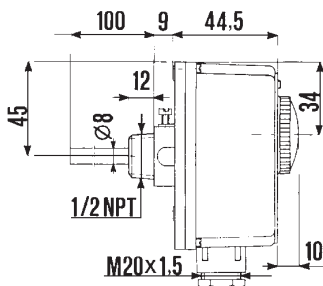

fig. 2.1

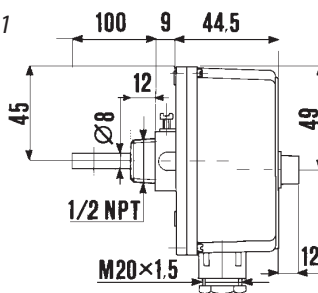
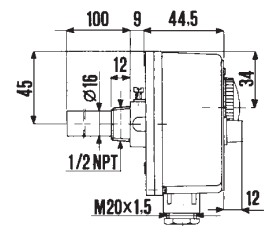
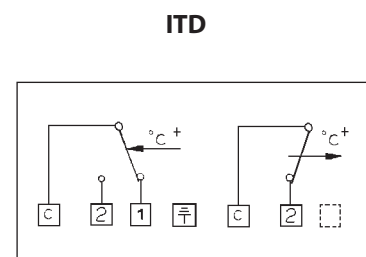
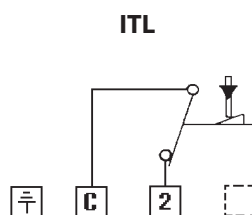
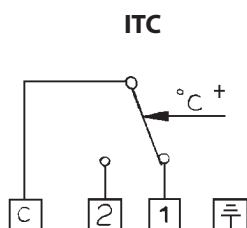

fig. 3.1



Wiring



Installation Guide

	ITC Control Thermostat	ITL Limit Thermostat	ITD Dual Thermostat
Control Function (thermal re-set)	●		●
Limit Function (manual re-set)		●	●
Dual Control and Limit Function			●
Temperature Range (Control) [°C]	0 – 90		0 – 90
Temperature Range (Limit)		(90 / 110°C) factory set to 90°C	(90 / 110°C) factory set to 90°C
Switching Differential	4 ± 1K	–	4 ± 1K
Switch Configuration	SPDT	SPST	SPDT (control) SPST (limit)
Switch Voltage Rating	220 / 240 Vac	220 / 240 Vac	220 / 240 Vac
Switch Current Rating	10 (2,5) A	10 (2,5) A	10 (2,5) A
Maximum Ambient Temperature (Head)	65 °C	80 °C	80 °C
Maximum Medium Temperature	150 °C	150 °C	150 °C
Supplied with ½" BSP (m) × 100 mm Pocket	●	120 mm Pocket	●
Dimensions of thermostat head (wide × high × deep) [mm]	54 × 110 × 55,5	54 × 110 × 56,5	100 × 110 × 56,5
Rated impulse voltage	4 kV	4 kV	4 kV
Earthing way: by screw	●	●	●
Pollution degree rating	degree 2	degree 2	degree 2
Mounting way: by screw	●	●	●
Controls intended for incorporation into appliances within the scope of the IEC 60335-1	●	●	●
Certification series	CA 02.03786 Serie TC2	CA 02.03785 Serie LSC1	CA 02.03781 Serie TLSC/A
Control action type	type 1B	type 1B	type 2K
Ball pressure test	75 °C	75 °C	75 °C

Please note that on ITD model, code 099-1062, the temperature range of the limit thermostat is set at 80°C and cannot be altered.

Danfoss Limited 丹佛斯

Climate Solutions • danfoss.uk • 0330 8086 888 • customerservice.uk@danfoss.com
Danfoss Ltd., Building 4, Uxbridge Business Park, Sanderson Road, UB8 1DH, Uxbridge, Buckinghamshire, UK

Any information, including, but not limited to information on selection of product, its application or use, product design, weight, dimensions, capacity or any other technical data in product manuals, catalogues descriptions, advertisements, etc. and whether made available in writing, orally, electronically, online or via download, shall be considered informative, and is only binding if and to the extent, explicit reference is made in a quotation or order confirmation. Danfoss cannot accept any responsibility for possible errors in catalogues, brochures, videos and other material. Danfoss reserves the right to alter its products without notice. This also applies to products ordered but not delivered provided that such alterations can be made without changes to form, fit or function of the product.

All trademarks in this material are property of Danfoss A/S or Danfoss group companies. Danfoss and the Danfoss logo are trademarks of Danfoss A/S. All rights reserved.